



AIR FORCE
HANDBOOK
10-2401

JANUARY 2004



FORCE PROTECTION BATTLELAB VEHICLE BOMB MITIGATION GUIDE

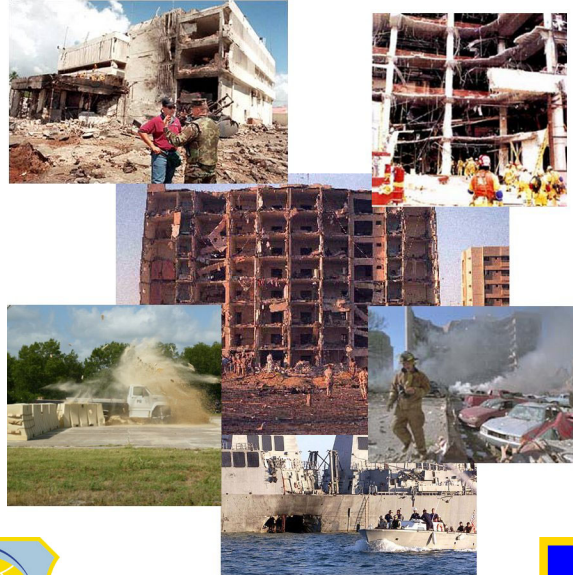

DEFENSOR FORTIS



FOR OFFICIAL USE ONLY

Distribution authorized to U.S. Government Agencies only.

This guide presents ready reference material associated with planning and executing programs and operations for protecting Air Force personnel and assets against the threat of vehicle bombs – it is designed for use by a variety of key players, ranging from the airman at the base gate to the installation commander. As with all sound force protection efforts, this guide tackles the threat class using a multi-dimensional approach incorporating threat detection and loss mitigation.

AFH 10-2401 establishes procedures and mitigation techniques necessary to protect Air Force transportation assets and facilities as well as the Air Force’s infrastructure.

TABLE OF CONTENTS

	Page
INTRODUCTION & OUTLINE.....	4
THE THREAT: HISTORICAL TRENDS AND FORECAST	5
EXPLOSIVES DETECTION METHODS.....	22
BLAST AND FRAGMENT MITIGATION METHODS.....	33
KEY POINTS FOR ON-SCENE COMMANDERS	74

OPR: USAF FPB/FPT (Capt L. Robert Moriarty)
Certified by: HQ USAF/XOF (Brig Gen James M. Shames, Director of Security Forces)
Pages 147

FOR OFFICIAL USE ONLY

Figures

Figure 1: M112 Demolition Charge..... 11

Figure 2: Typical Stick of Dynamite 12

Figure 3: One-Half Pound Block of TNT..... 14

Figure 4: Roll of M700 Time Fuse..... 18

Figure 5: Typical Electrical Blasting Cap..... 19

Figure 6: Typical Non-electrical Blasting Cap 20

Figure 7: Typical Roll of Military Det Cord..... 20

Figure 8: Explosive Detection Optimization Chart..... 24

Figure 9: Vehicle Search Areas 26

Figure 10: Explosive Detector Dog..... 27

Figure 11: Under Vehicle Searches 28

Figure 12: Vehicle Engine Compartments..... 29

Figure 13: Concrete Mixer..... 32

Figure 14: Reflected Pressure..... 34

Figure 15: Wall Breach 34

Figure 16: Secondary Debris 35

Figure 17: Primary Debris 35

Figure 18: Blast Wall..... 35

Figure 19: Fragment Barriers at the ECP 37

Figure 20: Jersey Barriers 39

Figure 21: Fragmenting Jersey Barriers 39

Figure 22: Earth Filled Barrier 39

Figure 23: Blast Wall Dimensional Requirements..... 40

Figure 24: Jersey Barriers Employed for Countermobility 41

Figure 25: Bitburg Barriers Employed for Countermobility..... 42

Figure 26: Sandbags Used for Fragment Protection 42

Figure 27: Water Filled Barriers Used for Countermobility 43

Figure 28: Concertainer Styled Barriers 43

Figure 29: Secondary Debris from Standard CMU Wall..... 44

Figure 30: CMU Debris Impact on Mannequins 46

Figure 31: Geotextile Fabric Retrofit Design 46

Figure 32: Geotextile Fabric 47

Figure 33: Blast and Fragment Hazard Zones..... 49

Figure 34: Standoff Charts Legend..... 53

Figure 35: Barrier Standoff Charts..... 54 - 59

Figure 36: Fixed Structure Standoff Charts..... 61 - 69
Figure 37: Expeditionary Shelter Standoff Charts..... 71 - 73

Tables

Table 1: Cases of Vehicle Bomb Employment Against U.S. Assets 7
Table 2: Terrorist Groups and Corresponding AORs 8
Table 3: Regional Vehicle Bomb Tactics 21
Table 4: Correct Usage Chart..... 51

FOR OFFICIAL USE ONLY

INTRODUCTION & OUTLINE

Purpose of This Guide

The purpose of this guide is to present the lessons learned from several major Force Protection Battlelab initiatives: the Vehicle Entry Explosive Search Strategy (VEESS), the Shock Mitigation for Entry Location Tests (SMELT), the Blast and Airman Injury Tests (BAIT), the Barrier Assessment for Safe Standoff (BASS) initiative, and the Retrofit and Overpressure Design of Structures (RODS) initiative.

Approach

Our approach is to provide best practices for conducting vehicle searches and using blast and fragment mitigation devices. The focus is on the implementation recommendations. You should proceed to the Endnotes or Annex for additional discussion, references, explanations, and rationale on the subject issue. This guide is not a substitute for common sense! It should be implemented with the flexibility and innovation that each unique circumstance requires.

Defensor Fortis.

FOR OFFICIAL USE ONLY

THE THREAT: HISTORICAL TRENDS

A. <u>Recurring Themes/Vulnerabilities: 1983-2003</u>	7
B. <u>Bomber Tactics</u>	9
1. <u>Favored Explosives</u>	9
2. <u>Typical Vehicle Bomb Make-Up</u>	15

EXPLOSIVES DETECTION

A. <u>Introduction</u>	22
B. <u>Recommended Strategy</u>	22
1. <u>Systems Approach</u>	22
2. <u>Detection and Search Optimization</u>	23
3. <u>Limitations</u>	25
4. <u>Vehicle Search Procedures</u>	26
5. <u>Special Case Vehicles</u>	32

BLAST AND FRAGMENT MITIGATION

A. <u>Introduction and Technical Definitions</u>	33
B. <u>Current Approach</u>	38
1. <u>Current Con Ops and Shortcomings</u>	38
2. <u>Intended Use and Context</u>	41
C. <u>Implementation/Guidance for Mitigation</u>	48
1. <u>Entry Control Points</u>	48
2. <u>Barriers</u>	52
3. <u>Fixed Structures</u>	60
4. <u>Expeditionary Structures</u>	70

KEY POINTS FOR COMMANDERS

A. <u>Historical Trends</u>	74
B. <u>Explosives Detection</u>	74
C. <u>Blast and Fragment Mitigation</u>	75

ANNEX

A. <u>Abbreviations</u>	76
B. <u>Glossary</u>	78
C. <u>Federal Government Points of Contact</u>	83
D. <u>References</u>	85
E. <u>Feedback Suggestion Page</u>	90

ENDNOTES

THE THREAT: HISTORICAL TRENDS

Recurring Themes and Vulnerabilities: 1983-2003

U.S. interests were targeted by terrorists using vehicle bombs (VBs) at least 22 times between 1983 and 2003. Considering the number of casualties and property damage inflicted per incident, vehicle bombs have been the most successful means of terrorist attack.

Table 1: Cases of Vehicle Bomb Employment Against U.S. Assets

Year	Location / Target	Device Explosive Weight in kg (lbs)	Explosive Used
1983	Lebanon – US Embassy	907.18 (2,000)	Military Grade
1983	Lebanon – US Marine Barracks	5,443.11(12,000)	Military Grade
1983	Kuwait – US Embassy	1,814.37 (4,000)	Military Grade
1984	Lebanon – US Embassy Annex	907.18 (2,000)	Military Grade
1985	Chile – US Embassy	29.48 (65)	Dynamite
1985	W Germany-Rhein Main AB	Unknown	Homemade
1985	W Germany-PX Frankfurt	Unknown	Unknown
1988	Italy-USO Club	18.14 (40)	Dynamite
1992	Peru-US Ambassador's Residence	49.90 (110)	Dynamite
1993	U.S. World Trade Center	544.31 (1,200)	Urea Nitrate
1993	Peru-US Embassy	181.44 (400)	ANFO*
1995	US Federal Building	2177.24 (4,800)	ANFO
1995	Saudi Arabia-OPM Sang	226.80 (500)	Military Grade
1996	Saudi Arabia-US Military Barracks	2,267.96 – 9,071.85 (5,000-20,000)	Military Grade
1998	Kenya-US Embassy	~ 793.79 (~ 1,750)	TNT
1998	Tanzania-US Embassy	~ 453.59 (~ 1,000)	TNT
2000	USS Cole	362.87 (800)	Comp C-4
2002	Pakistan-US Consulate	~ 100 (222)	ANFO
2003	Saudi Arabia-US Residential Compound	3 cars ~ 200 (400) , each	RDX
2003	Iraq-UN Headquarters	544.31 (1,200)	Military Grade
2003	Indonesia-Marriott hotel-regular venue for U.S. Embassy receptions	200 (440)	Included Potassium Chlorate
2003	Iraq-US Intelligence Headquarters	150 – 200 (330 – 440)	TNT

*See pages 10-15 for explosive abbreviation definitions.

FOR OFFICIAL USE ONLY

Vehicle bombs will continue to be used by terrorist groups against US interests due primarily to the wide availability of bomb making materials, the ability to conceal large amounts of explosives in vehicles, and the ease of getting a vehicle bomb to a target. **This combination of destructive capability and easy access of vehicle bombs makes blast and fragment mitigation, installation hardening, and standoff explosive detection among the highest priorities for force protection!** These priorities apply worldwide as evidenced by the types of vehicle bombs employed by the various terrorist groups active in each Area of Responsibility (AOR).

Table 2: Terrorist Groups and Corresponding AORs

Region	Terrorist Group	Type of Explosive Used
North America	Ramsey Yousef	Urea Nitrate
	Domestic Terrorist	ANFO
South America	FARC (Columbian)	ANFO / TNT
	ELN (Columbian)	ANFO / TNT
	MRTA (Peru)	ANFO / TNT
	Shining Path (Peru)	ANFO / TNT
Europe	PIRA (Ireland)	ANFO / ANS
	ETA (Spain)	RDX / Amotal
Middle East	GIA (Algeria)	ANFO / TNT
	EIJ (Egypt)	TNT
	IG (Egypt)	TNT
	HAMAS (Israel)	TNT
	PIJ (Israel)	TNT
Asia / Pacific	LTTE (Sri Lanka)	RDX / TNT
Transnational / State Sponsored	Iran	RDX / TNT
	Iraq	RDX / TNT
	Usama Bin Ladin	RDX / TNT
	Hizaballah	ANFO / TNT / Ammonal

FOR OFFICIAL USE ONLY

Bomber Tactics

This section is intended to provide you the characteristics of a typical vehicle bomb and possible tactics employed by a bomber. Favored explosives, the characteristics of such explosives, and popular Improvised Explosive Device (IED) characteristics will be addressed.

DEFINITIONS

1. **Vehicle bomb:** A vehicle modified to conceal and deliver large quantities of explosives to a target. The motive of a person using a vehicle bomb is to inflict a large number of casualties and cause gross property damage.

Whereas:

2. **Vehicle bombing:** Is an incident in which a small Improvised Explosive Device (IED) is attached to or placed in a vehicle for the sole purpose of killing the occupant(s). Motive is normally assassination.

FAVORED EXPLOSIVES

Specific Explosives and their Properties [taken from Air Force (AF) Tech Order 60A-1-1-9 (FOUO), and Director of Central Intelligence Interagency Intelligence Committee on Terrorism Community Counterterrorism Board's Improvised Explosive Devices – A Basic Reference, June 1997 (FOUO)].

FOR OFFICIAL USE ONLY

Amatol:

- State: Crystalline.
- Color: Yellow to dark brown.
- Characteristics: A mixture of Ammonia Nitrate (AN) and Trinitrotoluene (TNT). Amatol readily absorbs water and must be protected from moisture in the air. It is a main-charge explosive employed by nearly all foreign countries to make military ordnance.
- Sensitivity: Requires a booster explosive to initiate.

Ammonal:

- State: Solid.
- Color: Gray.
- Characteristics: A mixture of AN, TNT, and powdered aluminum. It is stable when dry and readily absorbs water. Ammonal is a main-charge explosive used by nearly all foreign countries to make military ordnance.
- Sensitivity: Insensitive.

Ammonium Nitrate (AN):

- State: Crystals or spherical grains called prills. This substance is very soluble in water making it less sensitive.
- Color: Colorless or white.
- Characteristics: Very stable. High grade AN is one of the most readily available commercial high explosives. Low grade AN is a very popular commercial fertilizer and is not considered a high explosive. Terrorists are able to increase the sensitivity of low grade AN by adding fuel oil (FO). The resulting product, if mixed properly and in the correct ratio, is an extremely effective high explosive (ANFO). Another fertilizer-based explosive used by terrorists is Urea Nitrate (its components are urea, sulfuric acid, nitric acid, and sodium cyanide).
- Sensitivity: Insensitive to impact. When mixed with fuel oil it becomes more sensitive but still requires a booster (typically TNT).

FOR OFFICIAL USE ONLY

Black Powder:

- State: Grains of various sizes
- Color: Slate-gray exhibiting a dull polish. Individual grains are coated with graphite that imparts a shiny appearance.
- Characteristics: A mixture of potassium or sodium nitrate, charcoal, and sulfur. It “attacks” all common metals when wet or excessively moist (except for stainless steel).
- Sensitivity: Extremely sensitive to heat, shock, friction, and static electricity. A few grains of black powder caught in the threads of a pipe end-cap as it is screwed into place can result in an explosion.

Composition C-4 (C4):

**Figure 1: M112
Demolition Charge
0.57 kg (1-1/4 lb) block
with adhesive strip on
back.**

- State: Plastic mass resembling putty. US military C4 (M112 demo charge, weighing 0.57 kg (1-1/4 pounds)) usually comes shrink wrapped in olive Mylar-film.
- Color: Dirty white to light brown.
- Characteristics: Very stable, does not absorb water, and does not react with most common metals.
- Sensitivity: Requires a blasting cap to facilitate detonation.

FOR OFFICIAL USE ONLY

Dynamite:

-State: Similar to a mixture of sawdust, clay and oil. The texture is loose, slightly moist, and oily. Usually found in cylindrical form (typically 2.86 to 3.81 cm (1-1/8 to 1-1/2 inches) in diameter and about 20.32 cm (8 inches) long). There are “gelatin dynamites” which have properties ranging from a thick viscous liquid to a tough rubbery substance. Gelatin dynamites do not absorb water.



Figure 2: Typical Stick of Dynamite

- Color: Light tan to reddish brown. Cylindrical wrappers are normally buff, white, or red-colored wax paper.
- Characteristics: Main ingredient in commercial dynamite is nitroglycerin. “Military Dynamite” contains no nitroglycerin. Nitroglycerin has a heavy, pungent, sweet odor. Inhalation of the fumes or skin contact will cause a persistent and severe headache.
- Sensitivity: Nitroglycerin based dynamites are very sensitive to heat, shock, and friction. Military dynamites are much less sensitive.

Nitro-Carbo-Nitrate (NCN):

- State: Packaged in waterproof cans, asphalt-laminated paper, and flexible plastic bags.
- Color: Colorless or white pellets.
- Characteristics: Manufactured mainly of AN and special ingredients to reduce static electricity and prevent hardening during storage. NCN is a main ingredient in “free-running” explosives...granular or small pellets poured around rigid

FOR OFFICIAL USE ONLY

explosive charges to fill all of the available space. “Free-running” explosives are packaged in 5.67, 22.68, 36.29, and 43.35 kg (12-1/2, 50, 80, and 100 pound) multi-wall paper bags, asphalt laminated burlap bags, or polyethylene bags. They may have an orange dye added.

-Sensitivity: Insensitive to handling and requires a high-explosive booster to initiate.

Pentaerythritol tetranitrate (PETN):

-State: Fine crystalline or granular powder.

-Color: White when pure or light gray when exposed to impurities.

-Characteristics: Its primary use is as the core of U.S. detonating cord.

-Sensitivity: Very sensitive to heat, shock, and friction, but when used in a detonating cord, very insensitive to flame, shock, and friction. Not adversely affected by moisture.

Potassium chlorate (Potash Chlorate):

-State: Solid fine crystals.

-Color: White.

-Characteristics: Used as an oxidizing agent in explosives and fireworks.

-Sensitivity: Highly reactive and may cause fire on contact with combustible materials. Material cannot burn but can accelerate the burning of other materials.

Rapid Detonating Explosive (RDX):

-State: Crystalline solid.

-Color: White.

-Characteristics: RDX is the main ingredient in C4. Powdered RDX makes up the core of some varieties of detonating (det) cord.

-Sensitivity: Not adversely affected by moisture. This substance is very sensitive to heat, shock, and friction. Yet, when used in det cord, it is very insensitive to flame, shock, and friction.

FOR OFFICIAL USE ONLY

Semtex:

- State: Solid.
- Color: Buff to reddish brown.
- Characteristics: Similar in all respects to C4. Semtex is a commercial high explosive manufactured in Semtin, Czech Republic.
- Sensitivity: Similar in all respects to C4.

Smokeless Powder:

- State: Flaked, granular, strips, or sheets.
- Color: Varies from pale yellow and translucent, black and opaque, to white and opaque.
- Characteristics: Smokeless powder is pyrocellulose and a mixture of nitrogen with ether-alcohol. Stable if kept dry and below 37.78 degrees Celsius (100 degrees Fahrenheit). Above 43.33 degrees Celsius (110 degrees Fahrenheit) it may spontaneously combust.
- Sensitivity: Highly susceptible to detonation by static electricity.

Trinitrotoluene (TNT):

Figure 3: 0.23 kg (1/2 lb) Block of TNT

- State: Flaked, granular, crystalline, or cast/pressed into cardboard containers.
- Color: Varies from straw yellow to yellowish brown; gradually turns dark brown after several days of exposure to sunlight.

FOR OFFICIAL USE ONLY

- Characteristics: At elevated temps may exude an oily liquid that becomes a low explosive when absorbed by wood, cotton, or similar materials.
- Sensitivity: Insensitive.

TYPICAL VEHICLE BOMB MAKE-UP

There is no standard type of vehicle associated with vehicle bombs. Vehicle selection depends on several factors: which vehicles are common for the region, availability of those vehicles, and the security environments near the intended target. For instance, well “hardened” facilities with good physical security measures in place (including significant standoff distances) may require the terrorist to use trucks with large enclosed cargo areas that provide increased explosive capacities capable of generating damaging blast effects over a large distance. Terrorists are imaginative... consider things like the use of emergency response vehicles being used by terrorists to slip past cordon checkpoints (possibly after an incident) to deliver a vehicle bomb.

Special Note: Do not discount the possibility that terrorists have observed your operations and may attempt to coax first responders to an incident only to entrap them with secondary and possibly tertiary explosive devices. Be wary of responding to the same location, building, etc., and staging your response from the same “command post” (CP) on repeat response/threat situations. Use military working dogs (MWD) and physical search methods to ensure CPs are secure.

Consider propane, oxygen, and acetylene tanks as suspicious. There are several documented examples of flammable/explosive gas filled cylinders (similar to propane tanks used for gas barbecues, and similar to oxygen / acetylene tanks used in auto body shops for welding/torch cutting) being added to the

FOR OFFICIAL USE ONLY

vehicle bomb's main charge in an effort to enhance the explosive effect. Also note the above mentioned tanks (as well as residential water heaters, and 208.20 L (55 gallon) drums) have been used as the casing for the explosive itself. Tanks have been cut open and filled with everything from ANFO, to military grade High Explosives (HE), to thermite (a high temperature incendiary mixture of aluminum powder and a metal oxide).

Terrorists may employ a "**blast directing**" technique. This involves adding steel plating or something with considerable mass around the main charge to funnel the blast wave toward the intended target. This technique would also increase the difficulty of detecting the explosive device with current x-ray detection techniques. Steel around the explosive main charge may also provide additional fragmentation.

Hiding Places for the Explosive Main Charge:

Typical places to find the explosive main charge include a vehicle's back seat, trunk, cargo bed, or the enclosed cargo hold area of water/sewage/fuel tankers, passenger vans, step vans, or semi-trailers.

Terrorists also use vehicle **gas tanks as a hiding place** for explosive main charges. The gas tank is cut open, filled with explosives, and sealed back up. A separate gas supply container is used to get the vehicle bomb to the target. Also watch for other **hidden compartments, false walls, or floors**.

Molding plastic explosives into shapes that are easily hidden in vehicle compartments and non-exposed crevices is a favorite tactic. Don't forget that AN prills can be "blown" (like insulation) into a vehicle's voids and body cavities.

FOR OFFICIAL USE ONLY

Main Charge Initiation Techniques:

The overwhelming means of successfully **initiating a vehicle bomb** is the **vehicle driver using a suicide switch**. There is also documented evidence that Remote Control (RC), Infrared (IR), electronic/mechanical time delay, and other electrical initiation devices are being successfully used. Often the vehicle's external radio antenna is used as the electronic initiator's signal-receiving antenna. **There may be an anti-tamper feature on the vehicle bomb**. For instance, a micro-switch that completes the electric firing circuit when the vehicle door(s) is opened, or a loose wire that contacts bare metal on the vehicle frame, could be used to initiate the detonation.

Predominant electrical initiation power sources include the vehicle battery, one or more 9-volt batteries, one or more 1.5-volt AA batteries, or any combination thereof. (Do not discount battery sizes not mentioned.)

The predominant **non-electrical initiation source** is a time fuse.

There are many different types of time fuses commercially manufactured. They are usually called "safety fuse," or "hobby fuse." The US military uses a M700 time fuse. The biggest disadvantage for a terrorist using a time fuse is its characteristic smoke and acrid odor (smells like sulfur and rotten eggs); although, the time fuse can be encapsulated in plastic or surgical tubing, minimizing its burning signature.

Commercial "safety fuse:" There are numerous brands which differ usually only in their exterior water proofing materials and color markings. Black powder is widely used as the burning core of safety fuse to provide the necessary delay prior to an explosion. It burns at a rate of 88.58 to 144.36 seconds per meter

FOR OFFICIAL USE ONLY

(27 to 44 seconds per foot) (when burned in the open at sea level). It is approximately 0.51 cm (0.2 inches) in diameter (the size of a wooden yellow pencil) and comes in 15.24 m (50 foot) paper wrapped rolls or coils. Colors range from bright orange and white, to black. The intent is to have it stand out against the background.

Military M700 time fuse: M700 has a black powder core and is incased in dark green plastic with yellow bands at regular intervals.



Figure 4: Roll of M700 Time Fuse

Timers can be anything from mechanical (wind-up), to electronic (digital) wristwatches, alarm clocks, or cassette players (using the ending of a playing tape to trigger the device).

Main Charge Initiation Devices:

Potential detonators include military and commercial blasting caps (electric and non-electric), commercial squibs (electric filament type detonators), improvised electric detonators – light bulbs, or camera flashbulbs filled with black powder or with their glass/plastic “shell” broken and the electric filament embedded into a container of black powder.

Blasting caps and detonating cord are both used to initiate a high explosive charge. A det cord can be “sensitized” by adding a non-electric blasting cap to one end. Blasting caps often resemble

FOR OFFICIAL USE ONLY

short, silver cigarettes. There are commercial blasting caps and military blasting caps. Detonating cord is similar in appearance to time fuse (approximately the same diameter, shipped in rolls/coils, and can be the same color), but it does not burn – it detonates.

Electric Blasting Cap: A long, skinny, cylindrical, metal cup with two insulated wires running through an insulated plug that is crimped into the open end. The wires can range from 1.22 to 121.92 meters (4 to 400 feet) long. Leg wires are between 20 and 24-gage, and the insulation may or may not be the same color on each wire. Electric caps are packaged individually in small cardboard tubes with the leg wires protruding and tied together.



Figure 5: Typical Electrical Blasting Cap

Leg wires and cardboard sheath for protection during transport.

Electric Squibs: Resemble electric blasting caps and consist of an aluminum or copper shell approximately 2.54 cm (1 inch) long (lengths up to 15.24 cm (6 inches) long are available) and are about the diameter of a wooden yellow pencil. They consist of a filament embedded in a base charge. When electrical current is applied the filament initiates the base charge.

FOR OFFICIAL USE ONLY

Non-electric Blasting Caps: Similar in appearance to the electric caps minus the leg wires. Typical M7 military non-electric caps are 5.97 cm (2.35 inches) long and 0.61 cm (0.241 inches) in diameter. They are packaged in quantity (e.g. 10 to a container, an "ammo-can", and 5 containers to a wooden crate).

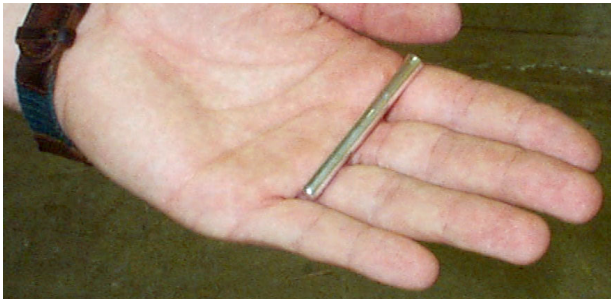

**Figure 6:
Typical
Non-electrical
Blasting Cap**

Detonating Cord (Det Cord): Military det cord has a dark green protective sheath, and comes in spools (much like wire). Commercial det cord comes in many colors of waterproofing material. The core of det cord is typically RDX or PETN. This gives the core a white or pink color. Det cord can be tied around, threaded through, or knotted inside of high explosives to cause them to detonate.



**Figure 7: Typical Roll of Military
Det Cord**

Typical **main explosive charge weights** range from 18.14 to 9,071.85 kg (40 to 20,000 pounds).

Primary tactics, firing systems, and explosives that have been used in vehicle bombs are shown in the table below. There are never any definite answers or ways when dealing with terrorists. The information in the below table should not be considered the terrorist's only modus operandi.

Table 3: Regional Vehicle Bomb Tactics

Region	Tactics	Firing Systems	Primary Explosives
North America	Delay	Time Fuse	Urea Nitrate
South America	Delay	Electronic, Mech Time, RC, Time Fuse	ANFO, TNT
Europe	Delay, Suicide	Electronic, Mech Time, RC, IR	ANFO, ANS, RDX, Amotal
Middle East	Suicide, Delay	Suicide Switch, Mech Timer, Electronic Timer, RC	TNT, ANFO
Asia - Pacific	Suicide, Delay	Suicide Switch, Mech Timer, RC	RDX, TNT
Transnational / State Sponsored	Suicide, Delay	Suicide Switch, Electronic Timer, RC, Delay, Time Fuse, IR	RDX, TNT, ANFO, Ammonal

NOTE: Training on vehicle search techniques/procedures and IED recognition should be obtained from your local Explosive Ordnance Disposal (EOD) unit. In the Air Force, EOD is organizationally located under the Civil Engineer.

EXPLOSIVES DETECTION

Introduction

This section describes a systems approach for detecting a vehicle explosive threat through an entry control process. The basis for the implementation guidance provided in this section is the result of a Force Protection Battlelab initiative—the Vehicle Entry Explosive Search Strategy (VEESS). This initiative provided the data and concept of operations that maximizes the detection capabilities associated with the entry control process.

It is significant that the word process is used in describing this systematic approach to explosive detection. The approach is both layered and tailored, drawing on the principles described below; however, it requires you to exercise a fair amount of judgment in order to flexibly apply those principles to your site specific conditions.

Recommended Strategy

SYSTEMS APPROACH

Systems design represents a popular concept for increasing the overall capability to detect explosives across the threat spectrum. The basic idea is to employ traditional vehicle search techniques and explosive detection technology into an overall strategy to detect vehicle bombs at entry control points

FOR OFFICIAL USE ONLY

The system design relies upon successively **layering** these resources and **tailoring** these technologies to address:

- 1) Your site specific threat,
- 2) The resources available to you, and
- 3) Your particular operating environment, in order to progressively detect and isolate explosive threats for immediate cordon and evacuation, followed by appropriate response actions by EOD technicians. This concept incorporates **isolation of the search stations** by exploiting distance and physical barrier methods in an effort to mitigate the effects of blast and fragmentation respectively.

DETECTION AND SEARCH OPTIMIZATION

The benefits associated with a “systems” approach are illustrated in the chart below¹. The chart presents combinations of “layered and tailored” systems and their detection frequency and false alarm rates. The systems considered are detailed on the following page.

FOR OFFICIAL USE ONLY

- Visual —Security Forces member (potentially mirror assisted)
- MWD —Military Working Dog
- UVSS —Under Vehicle Surveillance System
- VACIS —Vehicle And Cargo Inspection System (x-ray)
- ACM —Access Control Monitor (explosive trace detector)
- Ion Scan—Explosive trace detector

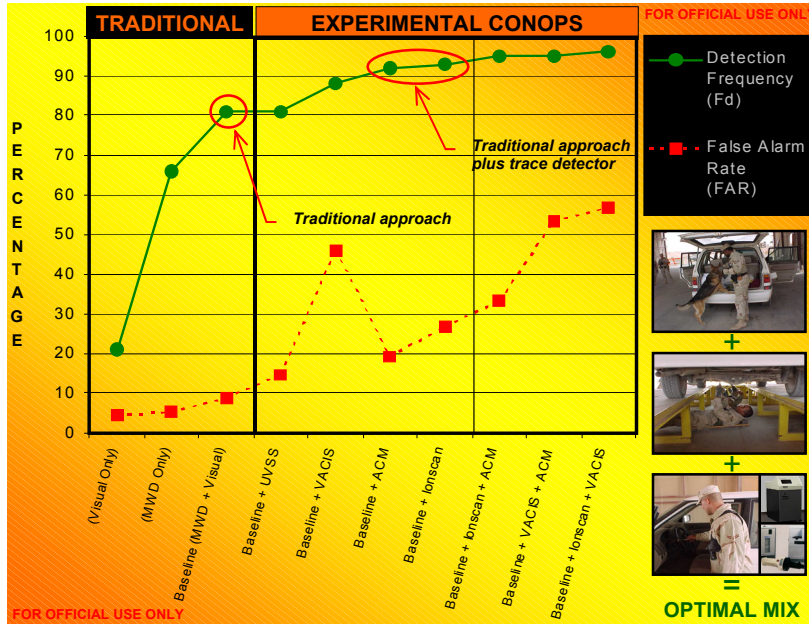

Figure 8: Explosive Detection Optimization Chart

The chart shows that physical inspection aided by an under vehicle inspection mirror, used in concert with military working dogs², achieves an 81% detection rate with a 10% false alarm rate. In the context of this guide, this combination will be called the "traditional strategy."

FOR OFFICIAL USE ONLY

Investment in relatively low cost explosive trace detector technology used with the "traditional strategy" achieves a 91-92% detection rate with a 20 or 27% false alarm rate (depending on which particular technology options are used). Significant investment above these levels only results in small gains in detection with significantly higher increases in false alarms.

The bottom line is that the most expensive systems (in one or all of the following resources: dollars, manpower, training, and/or maintenance) may not provide an appreciable benefit over simple, traditional, and robust technology systems – properly layered and tailored!

LIMITATIONS

Available data indicates that the use of vapor detection equipment used in isolation can provide a somewhat inaccurate assessment³. There are too many variables involved, including type of explosive, vapor concentration or lack thereof, environmental factors, and the construction of the container or vehicle. Thus, no single technological solution exists to adequately screen vehicles for large and small explosive devices. Detectors also require additional, extensive training of security personnel to interpret results. Severe climates may increase the probability of failures and required maintenance; screening vehicles at entry control points (ECPs) also impacts the routine flow of traffic, and most bulk detection devices are expensive.

FOR OFFICIAL USE ONLY

VEHICLE SEARCH PROCEDURES

Ask the driver of the vehicle to open all compartments, doors, the hood and trunk if applicable. During your search of a vehicle, if you find anything suspicious follow your local procedures (the search area will likely be evacuated and EOD will probably be notified). Remember that you are not only looking for the "big bomb" but any type of weapon, IED, or cache of explosives. A vehicle can be considered suspicious or contain a suspicious item if the driver refuses to open any compartment (e.g. hood, trunk, passenger doors, glove box, or even a package). Complete one search technique before starting another one.

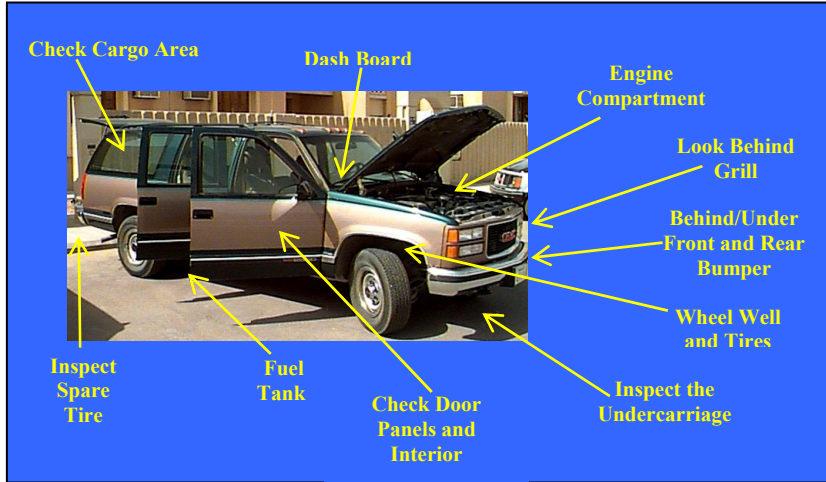

Figure 9: Vehicle Search Areas

To assist with the physical inspection the following guidelines are provided:

Explosive Detector Dog (EDD) Searches:

Although specific EDD search procedures vary according to local policy, individual MWD handler preference, and the unique abilities of individual canines, the typical approach, follows five general steps:

1. The driver exits the vehicle and opens all doors, the hood and trunk lids, any other compartments, any packages, and is placed in a holding area where he or she is not allowed to witness the vehicle search. (The driver should also be physically searched.)
2. The EDD team (the handler and the dog) proceeds directly to the downwind side of the vehicle.
3. The EDD team starts the search at a specific point and search in a counterclockwise manner, with the handler visually guiding the EDD to search for scents along the fenders, wheel wells, hubcaps, spare tire, and bumpers.
4. The dog is directed to search all opened compartments, vehicle seats, and floorboard.
5. The dog is directed to search any on-board packages and parcels.



Figure 10: Explosive Detector Dog

FOR OFFICIAL USE ONLY

The external portion of the vehicle:

1. Search from the bottom of the vehicle and work to the top.
2. It may be necessary to search by "Braille"... feel in areas that cannot easily be seen. If something is found, **do not** pull it out.
3. Look for body repairs, freshly painted sections, anything indicating tampering with the external surface of the vehicle.
4. Use a flashlight and mirror with a creeper (if possible) to carefully inspect under the vehicle.
5. Check the suspension, drive train, the wheel wells, the bumpers, under the engine, and above the gas tank.

Figure 11: Under Vehicle Searches



The red circle highlights an example of a suspicious switch box found under the vehicle.

FOR OFFICIAL USE ONLY

6. Look for any unusual devices taped, tied, screwed, etc. to the undercarriage.
7. Look for an unusually clean portion of the undercarriage, the presence of new weld marks or new bolts/screws.
8. Be sure all connections are properly made (e.g. the gas tank filler tube runs from the fill port to the tank, the exhaust pipe runs from the manifold the entire length of the vehicle to the muffler...inspect exhaust pipe for inserted objects).

Inside the engine compartment of a vehicle:

1. Take a minute to observe everything within view, and then start at the outer most edge (the front or side the battery is on) of the compartment and work towards the center of the vehicle.
2. Look for additional wires running from the vehicle's battery.

Figure 12: Vehicle Engine Compartments



Note the addition of a "new" red wire in the engine compartment. This should be treated as suspicious.



FOR OFFICIAL USE ONLY

3. Look for out of place or unusually clean components, devices, and/or wiring and electrical tape.
4. Check under larger components, e.g. the air cleaner and fan blade shrouds for packages or devices.
5. Look for containers that may contain fuel, indicating the gas tank may contain an explosive charge.
6. Inspect the "insulation" on the firewall, hood, etc. for rips, tears, bulges, etc. and any subsequent repairs.
7. Look for additional wires running from the hoodlight or the absence of a bulb in the hoodlight socket.

Inside the trunk of a vehicle:

1. Take a minute to observe everything within view then begin at the edge and inspect inward.
2. Pay attention to packages/devices (e.g. alarm clocks, iron or PVC pipe) that look out of place. Even things normally found in a trunk should be inspected (e.g. tool box, supplies – blankets & water containers etc.)
3. Look for bits of electrical tape, wire, stripped wire insulation, string, fine wire, fishing line, and/or time fuse on the floor.
4. Be sure to check for hidden compartments (e.g. spare tire well, jack/tool storage).
5. Check for any additional or improvised wires attached to the brake lights or rear turn signals.
6. Don't forget to look in the area behind the rear seat.

Inside the passenger compartment of a vehicle:

1. Take a minute to observe everything within view, then start at the floor and work up. Pay close attention to packages/devices (e.g. alarm clocks, iron or PVC pipe) that look out of place.
2. Look for bits of electrical tape, wire, stripped wire insulation, string, fine wire, fishing line, and/or time fuse on the floor, dash, or seats.
3. Check under floor mats for wires or switches.
4. Use a flashlight to check under all seats for anything out of the ordinary.
5. Check behind speaker grills and in ashtrays.
6. Check the door panels for signs of tampering.
7. Be sure the vehicle driver opens the glove box and inspect inside of it.
8. Check under the dash for any loose or "unusual" wiring. Pay attention to any "modifications" done to the dash (e.g. extra switches with no label as to their function, indicator lights that remain on although the vehicle is not running).
9. Check the roof liner for bulges, rips, and/or repairs indicating possible concealment of an explosive device.

Common sense is an extremely valuable guide. If the vehicle is a tractor-trailer type, treat the tractor like a "bigger" passenger vehicle. The trailer should be thoroughly searched with the EDD and off loaded if necessary to methodically inspect all cargo. Be aware that simply inspecting the perimeter cargo is not thorough enough...there may be explosives hidden at the center.

Be thorough, use your imagination and put yourself in the "terrorist's shoes"...ask yourself, "where would I hide an explosive device or quantity of explosives?"

FOR OFFICIAL USE ONLY

SPECIAL CASE VEHICLES

Certain special types of vehicles require unique search techniques and procedures. Water/fuel tankers, cement mixer trucks, and hot-mix asphalt delivery trucks represent potential bomb platforms that may not be effectively screened using traditional MWDs or physical inspection methods previously mentioned.



Figure 13: Concrete Mixer

Security Force members performing a physical inspection on a cement mixer. Note two checking the "funnel" and one using an under vehicle inspection mirror to check the undercarriage.

The current approaches used to address these special case vehicles are:

- 1) Control access by cross-loading cargo to known "clean" vehicles within your perimeter.
- 2) Establishing transfer stations – pumping the cargo from the "dirty" vehicle outside the perimeter to bladders or "clean" vehicles inside the perimeter, never letting the vehicles get near the assets you are protecting.
- 3) Individually searching each vehicle before cargo is loaded at the origin and then escorting the delivery vehicle on base.
- 4) Physical inspection (personnel and MWDs)

FOR OFFICIAL USE ONLY

BLAST AND FRAGMENT MITIGATION

Introduction and Technical Definitions

The goal of employing blast and fragment mitigation techniques is to reduce the number of casualties associated with terrorist bombings. The primary explosive quantities addressed in this section are vehicle bombs found in passenger cars, 226.80 kg (500 lbs.), vans or cargo trucks, 453.59 kg (10,000 lbs.), and tanker or tractor-trailer trucks, 9,071.85 kg (20,000 lbs.). These charge weights, and those referred to later in this section are TNT equivalent weights.

The detonation of vehicle bombs generates four primary hazards to personnel in fixed structures, shelters and in the open:

Primary fragments—Consisting of vehicle debris ejected at moderate to high velocities and generally low trajectories.

Secondary fragments from barriers and structures—Countermobility devices and structures near the large vehicle bomb (LVB) and ECP will be completely involved in the LVB explosion and will produce secondary debris as they are broken up by the force of the blast. This debris will again be launched at relatively low trajectories, but will have significant velocity.

Secondary debris in fixed structures—Window glass and some structural materials such as masonry walls can fail and become debris that is hazardous to personnel occupying perimeter spaces in buildings.

Blast—The force of the explosion as it is transmitted through the air (blast) can cause injury to personnel in the open. It can pick up

FOR OFFICIAL USE ONLY

and translate ground debris, and can fail and collapse structures, generating numerous injuries and deaths.

These hazards are considered in the siting, barrier, and retrofit recommendations presented in this section.

Technical Definitions

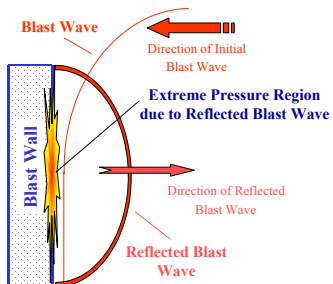

Figure 14: Reflected Pressure

The blast pressure or the shock wave is also known as **overpressure**. **Reflected pressure** is the pressure of the blast wave that occurs when it impacts a wall or vertical surface. **Incident pressure** is the pressure of the blast wave out in the open before it hits a reflective surface.

Breach occurs when brittle materials like concrete are destroyed by very intense and local overpressure, resulting in a hole.

Spall occurs when fragments are dislodged at high velocities from the backside of a brittle material like concrete.

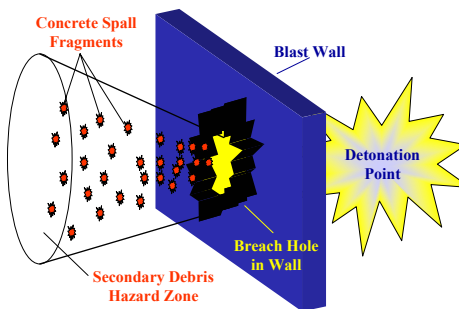

Figure 15: Wall Breach

Secondary debris occurs when objects surrounding a detonation become projectiles and fragments with enough energy to create damage of their own. Secondary debris can be categorized as near field secondary debris that results from barriers or ECP structures and, building debris that results from the blast wave blowing out windows and walls.

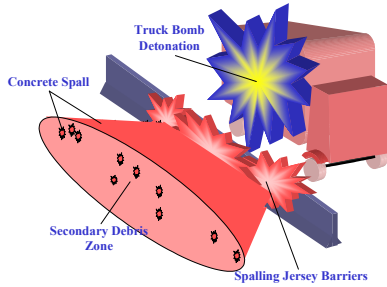

Figure 16: Secondary Debris

Primary fragments are parts, pieces, and fragments of the truck and bomb that are thrown outward from the detonation at high velocity. Primary fragments are generally the most lethal projectiles from a bomb detonation.

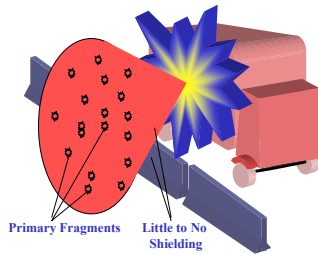
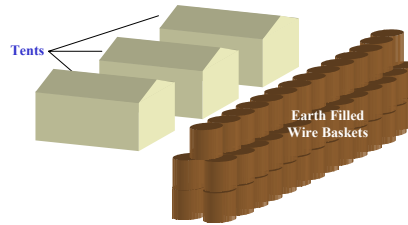

Figure 17: Primary Debris

Figure 18: Blast Wall



Far field conditions generally refer to relatively low overpressures (less than 68.95 kPa (10 PSI)) found at greater distances from the detonation point.

Near field refers to the area immediately surrounding a detonation in which blast and fragment damage will be extensive.

Blast Walls are protective walls employed at an occupied position (such as a building) that are designed to reduce reflected pressures to incident pressures on vertical surfaces.

Blast Barriers are employed near the LVB (at the ECP) and can attenuate blast in their “shadow” to levels acceptable for hardened structures. Blast barriers do not reduce blast damage significantly for conventional and expeditionary structures, and are ineffective for mitigating blast effects.

Fragment Barriers are employed close to the LVB (at the ECP) and in the far field adjacent to occupied positions. Fragment barriers provide protection from impacting primary and secondary debris.

FOR OFFICIAL USE ONLY

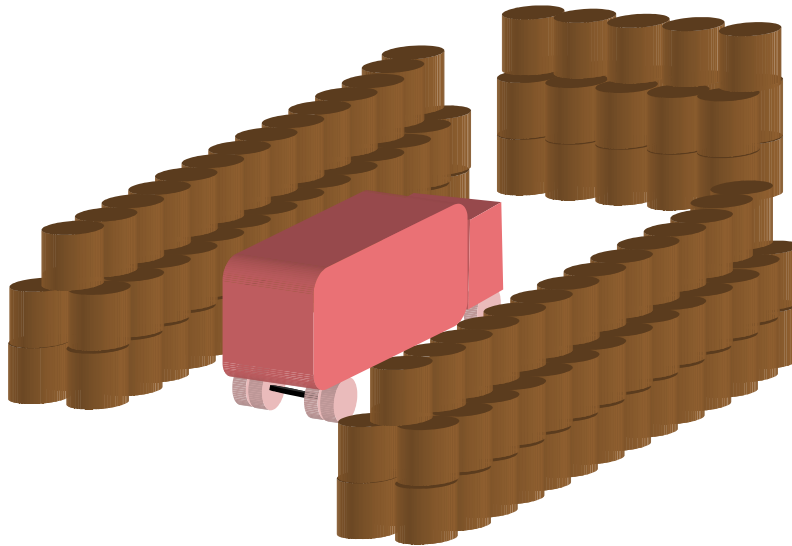

Figure 19: Fragment Barriers at the ECP

The above figure represents the appropriate context for employing *fragment* mitigation. These barriers *should not* be employed with the intent to mitigate blast. (Refer to “Intended Use and Context” section.)

Current Approach

The purpose of this section is to describe the current Con Ops for blast and fragment mitigation device employment, and then describe the recommended intended uses for these devices.

CURRENT CON OPS AND SHORTCOMINGS

Concrete Barriers

Jersey and Bitburg barriers are typically employed for Countermobility or blast/fragment mitigation around ECPs and approach avenues. Concrete barriers employed in this fashion can be effective in stopping primary debris, if they are sufficiently tall. However, they also may become secondary debris hazards in the immediate vicinity of a large explosion. Instead of protecting assets from blast or fragment damage, concrete barriers can cause additional damage by becoming secondary debris.

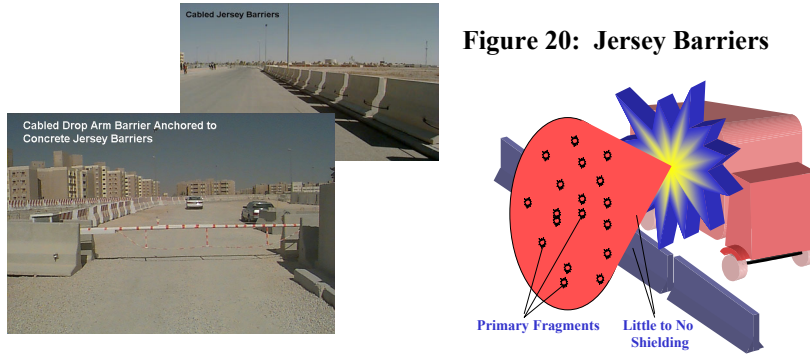

Figure 20: Jersey Barriers

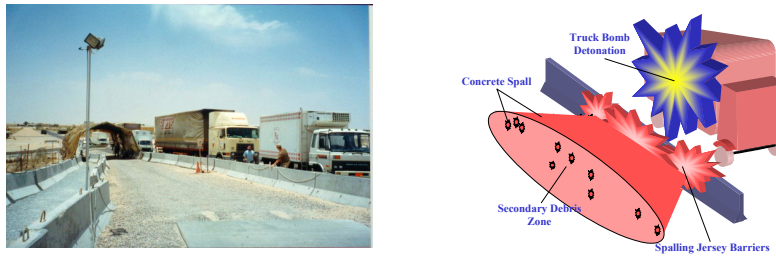

Figure 21: Fragmenting Jersey Barriers

Earth-Filled Barriers

Earth-filled barriers are typically employed around expeditionary structures to provide blast and fragment damage protection, and consist of things like berms, concertainer walls, and sandbags. As fragment protection, these barrier types work extremely well; however, for blast mitigation purposes these barriers will reduce structural damage only slightly by reducing reflected pressures to incident pressure levels.



Figure 22: Earth Filled Barrier

FOR OFFICIAL USE ONLY

Permanent Barriers

Permanent barriers generally refer to structures such as blast walls that are intended to remain as a permanent facility hardening measure. Generally, these structures have been employed in one of two ways: 1) At the anticipated detonation location or 2) Immediately in front of the building they are designed to protect. Unfortunately, test data indicates that employing a blast *barrier* at the detonation point provides no appreciable increase in protection in all but a very few building types. However, constructing a blast *wall* immediately in front of occupied structures can provide significant protection. The blast wall effectively reduces the pressure from a reflected pulse to an incident pulse, permitting reduced safe standoff distances. Blast walls can be massive, however, requiring a height equal to 1.5x the protected structure height, and a width equal to 2x the protected structure width. The wall also must be located no further than one story height from the protected face of the building.

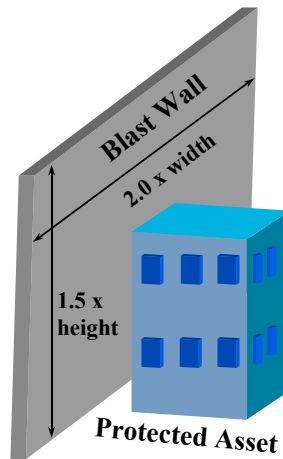

Figure 23: Blast Wall Dimensional Requirements

FOR OFFICIAL USE ONLY

INTENDED USE AND CONTEXT

The purpose in presenting this information on intended use is to provide you with the appropriate context in which to implement these devices, and to remedy the shortcomings addressed above.

Barriers

Jersey Barrier (See also Soil-Backed Barriers & Sandbags)

- Intended Use: Countermobility
- Should not be used to mitigate blast damage in the near field
- Should not be used to mitigate fragment damage in the near field
- May be used to mitigate fragment damage in the far field region
- Must always be inter-connected with cables



Figure 24: Jersey Barriers Employed for Countermobility

Bitburg Barrier (See also Soil-Backed Barriers & Sandbags)

- Intended Use: Countermobility
- Should not be used to mitigate blast damage
- Should not be used to mitigate fragment damage in the near field
- May be used to mitigate fragment damage in the far field



Figure 25: Bitburg Barriers Employed for Countermobility

Sandbags

- Intended Use: Fragment Mitigation
- May also be used behind Jersey and Bitburg barriers to reduce or eliminate secondary debris hazard associated with spalling concrete.
- If implemented correctly, may be used to mitigate blast damage.



Figure 26: Sandbags Used for Fragment Protection

Water or Sand Filled Plastic Barriers

- Intended Use: Limited Countermobility for low speed impact (certified by tests)
- Could be used to mitigate fragment damage in the near field depending on the threat level
- May be used in the far field to mitigate fragment damage



Figure 27: Water Filled Barriers Used for Countermobility

Concertainer Styled Barriers

- Intended Use: Blast and Fragment Mitigation
- May also be used for Countermobility purposes.

Figure 28: Concertainer Styled Barriers Used as Blast Walls and Fighting Positions (Concertainer Construction Techniques per ERDC Guidance)



FOR OFFICIAL USE ONLY

Soil-Backed Barriers

- Intended Use: Countermobility
- May also be used for fragment mitigation in the near field if implemented correctly
- May be used for fragment mitigation in the far field
- Implemented in the appropriate manner, soil-backed barriers may also provide some blast mitigation capability in the far field

Permanent Structure Retrofits

Primary Fragment Protection—Retrofitted fixed structures are assumed to be in the far field effects region if the LVB detonates at the ECP. Primary and secondary fragment impacts will be indirect and will result from high launch angles. Existing building construction materials (walls and roofs) should be adequate to prevent injuries from primary LVB debris and secondary ECP barrier debris.

Secondary Debris—Existing monolithic annealed window glass (regular glass) and wall materials in framed construction (steel or concrete frame buildings) are sources of secondary debris in buildings. Glass shards from monolithic plate glass will cause severe lacerations.

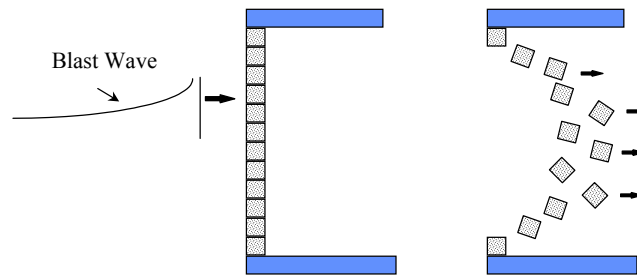

Figure 29: Secondary Debris from Standard CMU Wall

FOR OFFICIAL USE ONLY

Wall debris can be propelled into building spaces with sufficient velocity to cause severe blunt trauma injuries.



Figure 30: CMU Debris Impact on Mannequins

*Window Retrofits*⁴—Window glass retrofitting can be accomplished through the use of window films and window replacements to limit glass shard hazards as windows fail. Retrofits can reduce potentially lethal annealed glass shards to low hazard levels by retaining shards with films and catcher bar systems or by retaining shards on the interlayer present in retrofit laminated glass.

Annealed glass fragments can be retained and contained using a combination of commercially available polyester “daylight application” security window films with a catcher bar system. The DoD Unified Construction Standard recommends a minimum of 6 mil film. 8 mil film is recommended to eliminate the possibility of tearing.

Because of the blunt trauma hazard remaining when glass shards are retained on film, catcher bars are recommended when film retrofits are applied to windows.

FOR OFFICIAL USE ONLY

Window replacements may consist of laminated glass products, insulated laminated glass products, or ballistic resistant glass. New 2 and 4-sided attached films are also effective at reducing shards. Glass hazard or “bomb-blast” curtains may also be installed to mitigate shard hazards.

Wall Retrofits⁵—Wall debris generated when the concrete block or brick walls of a structure fail can essentially be “caught” with geotextile fabrics spanning the wall height and attached to the floors and ceilings of the structures. Reinforced concrete wall backing can also be employed to mitigate this debris hazard.

Figure 31: Geotextile Fabric Retrofit Design

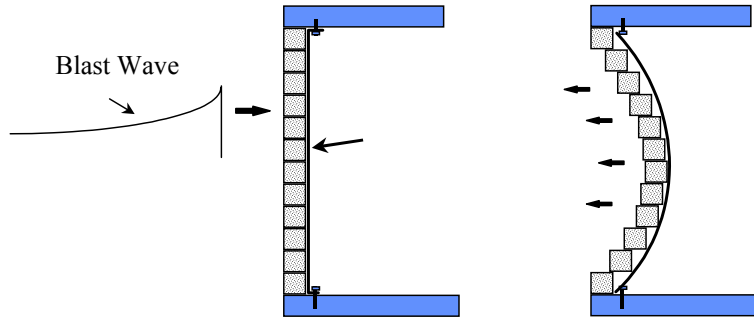
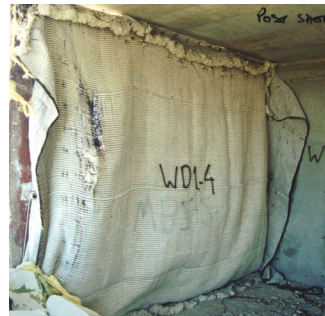

Figure 32: Geotextile Fabric



Blast Protection and Collapse Prevention—Collapse of conventionally constructed load bearing or frame structures occurs primarily due to loss of supporting exterior walls in the load bearing case, or due to loss of columns, beams and lateral support elements (shear walls and floors) in the framed structure case. Column, beam and lateral support retrofits can be employed, but structural engineering expertise is required for design and construction of these components.

Fixed Structure Hardening – Structural collapse is prevented by hardening critical frame members; such as load bearing members and members providing structural stability (floors and shear walls). Increasing the column dimensions through the addition of concrete and reinforcing steel provides column strengthening of reinforced concrete columns. Structural floor sections in conventional construction are generally designed to resist downward or gravity loads. Loads from LVB explosions can propagate into interior structure spaces and lift floors as well as push them downward. Floor retrofits consist mainly of adding reinforcement and mass (concrete) to the top surface of structural floors to gain flexural capacity in the upward direction. Requirements for the prevention of progressive collapse are presented in the Unified Facilities Criteria (UFC) DoD Minimum Antiterrorism Standoff Distance for Buildings (21 September 2002) UFC 4-010-10.

Blast Walls—Blast walls can be employed to attenuate the loads generated by the LVB at the structure by reducing the loads from a “direct” load to an “indirect” load or pressure. These walls are constructed in close proximity (a few feet) from the protected structure. They may consist of the earth filled barriers or soil-backed concrete barriers described previously, or may be of reinforced concrete. Reinforced concrete blast walls must be designed by a qualified “blast” and structural engineer, to ensure the blast walls will not fail under direct loads. Failure of the blast walls will produce

FOR OFFICIAL USE ONLY

secondary debris hazardous to personnel in occupied building spaces. See the Endnotes for more details on retrofitting.

Implementation/Guidance for Mitigation

The objective of this section is to provide you with the “nuts and bolts” of setting up and implementing blast and fragment mitigation measures in the most optimum configuration possible for a given set of conditions or restraints. This section will build off of the principles discussed in the “Intended Use and Context” section, but is tailored to stand alone in the sense that all of the recommendations for site layout, standoff, and barrier selection are provided in the following discussion.

Throughout the following discussion, three primary threat categories will be addressed: Cars, 226.80 kg (500 lbs), Vans, 4,535.92 kg (10,000 lbs), and Tanker Trucks or Tractor Trailers, 9,071.85 kg (20,000 lbs).

ENTRY CONTROL POINTS

To optimally configure an Entry Control Point (ECP), the specific explosive threat must first be addressed. The three primary levels of explosive threat that will be addressed throughout this discussion of ECP’s and the ensuing sections are those defined above; namely, the car, van, and tanker truck. Because the degree of protection varies so widely between these explosive threats, a discussion of optimum site layout will be specific to the explosive quantity. Entry control point design is fully described in the Air Force Entry Control Facilities Design Guide (13 February 2003).

Orientation

For optimum blast and fragment mitigation, two primary measures should be considered. The first, orienting the ECP, will be

FOR OFFICIAL USE ONLY

considered here. The second, catching fragments and knocking down blast with suitable barriers, will be addressed in the “Blast/Frag Mitigation Plan” section. There are two primary elements to consider in laying out the orientation for an ECP, blast and fragment zones.

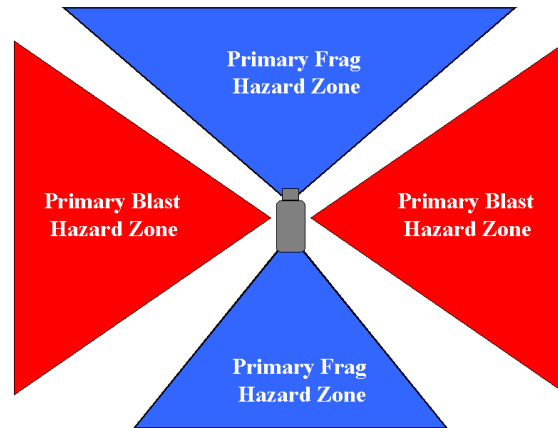

Figure 33: Blast and Fragment Hazard Zones

Fragment Hazards can generally be mitigated effectively with proper barrier implementation; consequently, blast is generally the “driver” in selecting vehicle/ECP orientation. The vehicle should optimally be pointed “head on” towards the assets to be protected to reduce near field blast pressure.

Blast/Frag Mitigation Plan

Factors to be considered in mitigating a vehicle bomb threat can be divided into two major components: debris hazard distances and safe structure distances. For quick reference, four different types of charts have been created to assist the manual user in determining these distances, which have been color-coded for ease of reference.

FOR OFFICIAL USE ONLY

1. *Debris Hazard Distance charts*
2. *Expeditionary Structure Safe Distance charts*
3. *Fixed Structure Wall Safe Distance charts*
4. *Fixed Structure Window Safe Distance charts*

Injury-based safe standoff charts will be available in the electronic publication of the VBMG (FY 2004).

Charts for both debris and structures must be utilized in conjunction with one another. Almost all cases will require referencing at least two of the four chart types.

1. *Debris Hazard Distance charts*

The Debris Hazard Distance charts should be referenced for all debris hazards, as this is the only chart type out of the four in this manual that deals with debris. Each chart deals with a different charge weight and barrier combination. Regardless of whether or not there are expeditionary or permanent structures present, these charts must be referenced for debris information.

REMEMBER: The Debris Hazard Distance charts must be referred to for primary fragment information, which exists regardless of the threat size, structures present, etc.

2. *Expeditionary Structure Safe Distance charts*

These charts contain information for various types of expeditionary structures, with or without shock dissipating blast walls. In checking expeditionary structure safe distances, the user must also refer to the Debris Hazard Distance charts for debris information.

- 3-4. *Fixed Structure Wall and Window Safe Distance Charts*

For permanent structures, there are two types of charts: the Fixed Structure *Wall* Safe Distance charts and the Fixed Structure *Window* Safe Distance charts. Both charts must be used together to evaluate the safe distances for fixed structures. The wall charts give

FOR OFFICIAL USE ONLY

the safe distances for standard and retrofitted CMU walls in fixed structures. The window charts do the same for the windows of the fixed structure, with variables for the window size, thickness, and protective film. Again, in checking permanent structure safe distances, the user must still refer to the Debris Hazard Distance charts for debris information.

The table below shows the necessary charts for different situations. To reiterate, in every situation without exception, the Debris Hazard Distance charts must be used. One additional structure chart must be used when expeditionary structures are present, and two additional structure charts must be utilized when fixed structures are present.

Table 4: Correct Usage Chart

Situation	Necessary Charts
No Barriers or Structures Present	1. Debris Hazard Distance
Barriers Present (with or without structures)	1. Debris Hazard Distance
Expeditionary Structures Present (with or without barriers)	1. Debris Hazard Distance 2. Expeditionary Structure Safe Distance
Fixed Structures Present (with or without barriers)	1. Debris Hazard Distance 2. Fixed Structure Wall Safe Distance 3. Fixed Structure Window Safe Distance

REMEMBER: A blast wall is immediately next to a structure and used to reduce the overpressure of the blast. A counter mobility barrier is used to stop or control vehicles and is located next to the blast and does not mitigate blast.

The “Safe Distance” for blast described in the charts below is the minimum standoff distance required for the given explosive threat condition for a typically constructed, steel or concrete frame building with unreinforced concrete masonry unit (CMU) infill walls using the barrier types specified. The “Safe Distance” for fragments is for people in the open or personnel in perimeter spaces of buildings. Test

FOR OFFICIAL USE ONLY

data generated in the BAIT/BASS/RODS series⁶ was used to determine safe standoffs. The standoff is determined based on the maximum distance for the worst of the three threats: primary debris⁷, secondary debris⁸, and blast⁹. Standoffs for both standard and retrofitted window glass are presented, as window breakage and the resulting hazards is often the determining factor in safe standoff determination for buildings.

It should be pointed out that the standoff distances presented below are for design purposes. **They are not intended to replace or supersede EOD evacuation guidance and policy.**

BARRIERS

The following recommendations are made to optimize the blast and fragment mitigation qualities of an ECP through the use of barriers:

All barriers at the ECP are assumed to be approximately 3.05 meters (10 ft) or 10.67 meters (35 ft) from the LVB.

Fragment mitigation using concrete barriers will be limited to the height of the barrier. The further the barrier is from the detonation point, the higher the barrier will need to be to stop an equivalent number of fragments. Recommended heights for earth, sandbag, and concertainer style barriers are presented on the charts.

The three threat levels are, again, the car, 226.80 kg (500 lbs), the van, 4,535.92 kg (10,000 lbs), and the tanker truck or tractor trailer, 9,071.85 kg (20,000 lbs). If specific and detailed information is needed on pressure and impulse, Endnote 9 should be consulted for the appropriate reference materials. The building type analyzed is detailed in the above paragraphs. These charts should be used with a common sense approach to determine the correct course of action.

FOR OFFICIAL USE ONLY

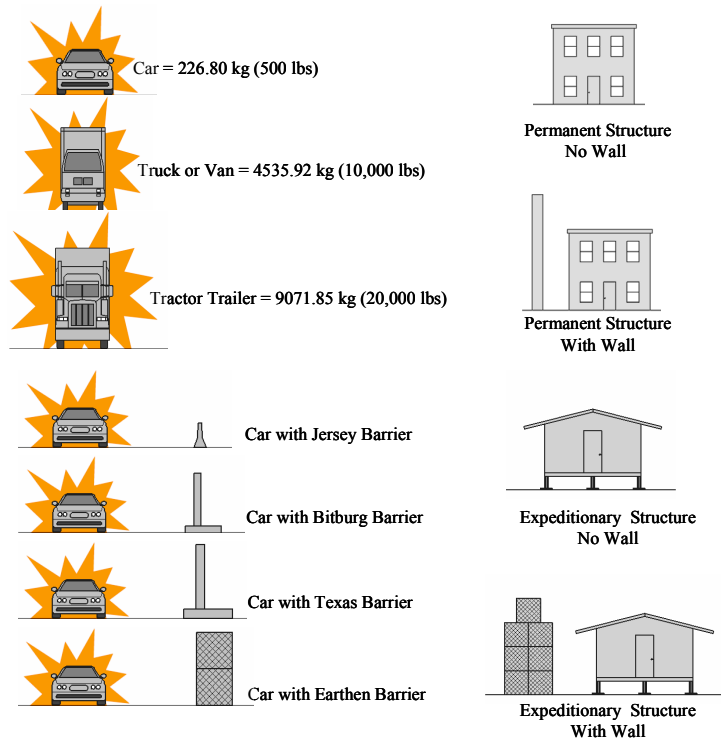
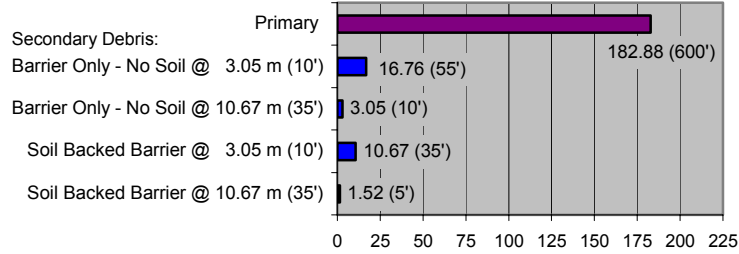

Figure 34: Standoff Charts Legend

Debris Hazard Distance
Charge Weight: Low **Barrier Type: Jersey**



Debris Hazard Distances - Meters (ft)



Debris Hazard Distance
Charge Weight: Low **Barrier Type: Bitburg**



Debris Hazard Distances - Meters (ft)

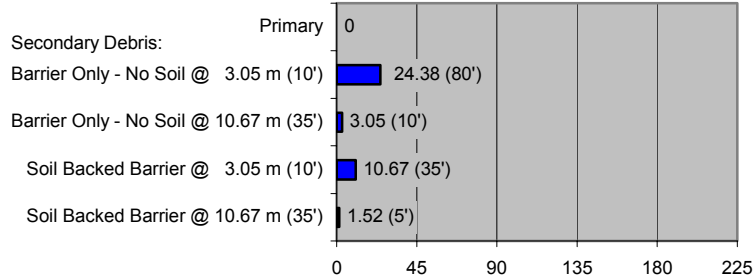

FOR OFFICIAL USE ONLY

Debris Hazard Distance

Charge Weight: Low **Barrier Type: Texas**



Debris Hazard Distances - Meters (ft)

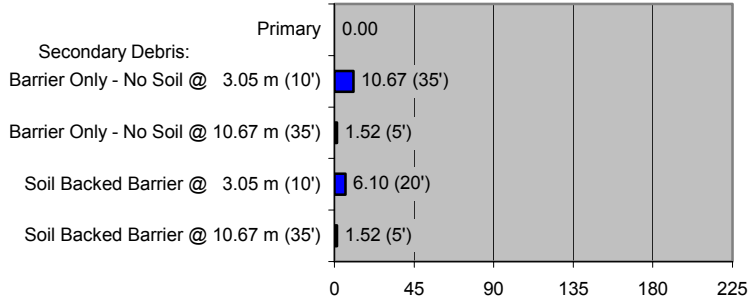

Debris Hazard Distance

Charge Weight: Low **Barrier Type: Earthen**

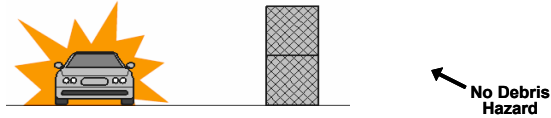

“NO HAZARDOUS DEBRIS”

Required Dimensions:

	Base in meters (feet)	Height in meters (feet)	Top in meters (feet)
Earth Berm	2.44 (8)	2.44 (8)	0.61 (2)
Hesco Bastion	1.22 (4)	2.44 (8)	1.22 (4)
Sandbags	1.83 (6)	2.44 (8)	0.61 (2)

Debris Hazard Distance

Charge Weight: Medium Barrier Type: Jersey



Debris Hazard Distances - Meter (ft)

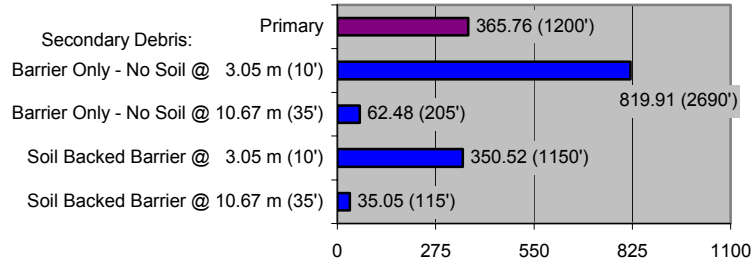

Debris Hazard Distance

Charge Weight: Medium Barrier Type: Bitburg



Debris Hazard Distances - Meter (ft)

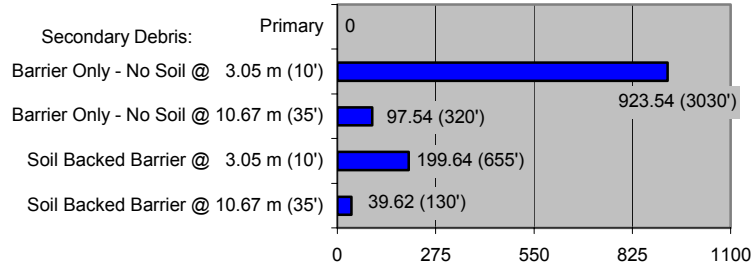

FOR OFFICIAL USE ONLY

Debris Hazard Distance
Charge Weight: Medium **Barrier Type: Texas**



Debris Hazard Distances - Meter (ft)

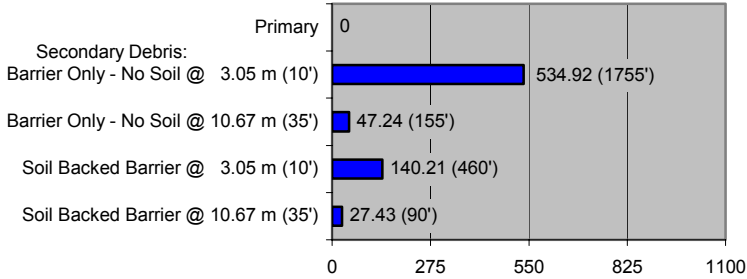

Debris Hazard Distance
Charge Weight: Medium **Barrier Type: Earthen**

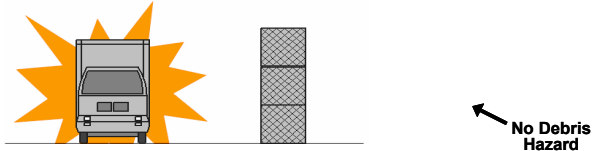

“NO HAZARDOUS DEBRIS”

Required Dimensions:	Base in meters (feet)	Height in meters (feet)	Top in meters (feet)
Earth Berm	3.66 (12)	3.66 (12)	0.61 (2)
Hesco Bastion	2.44 (8)	3.66 (12)	2.44 (8)
Sandbags	2.44 (8)	3.66 (12)	0.61 (2)

Debris Hazard Distance

Charge Weight: High **Barrier Type: Jersey**



Debris Hazard Distances - Meter (ft)

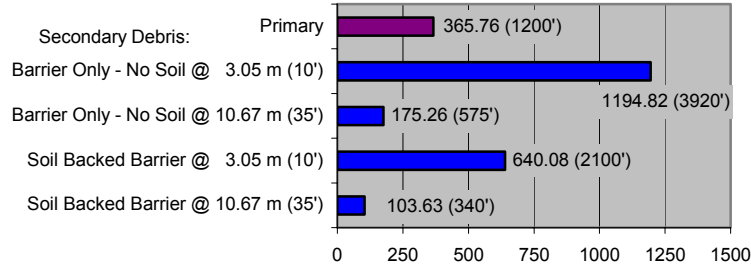

Debris Hazard Distance

Charge Weight: High **Barrier Type: Bitburg**



Debris Hazard Distances - Meter (ft)

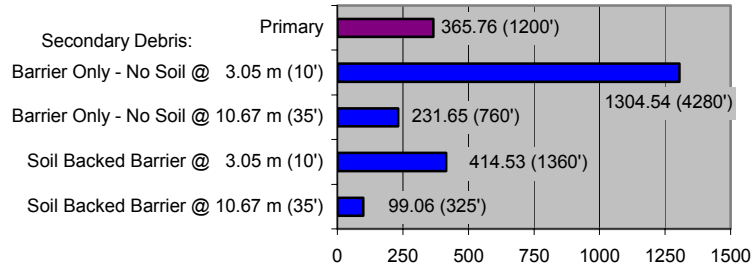

FOR OFFICIAL USE ONLY

Debris Hazard Distance

Charge Weight: High **Barrier Type: Texas**

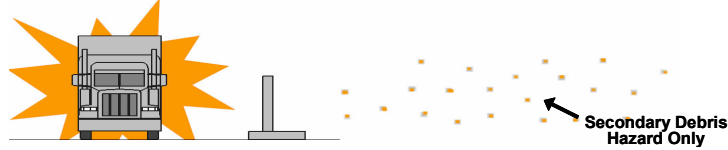

Debris Hazard Distances - Meter (ft)

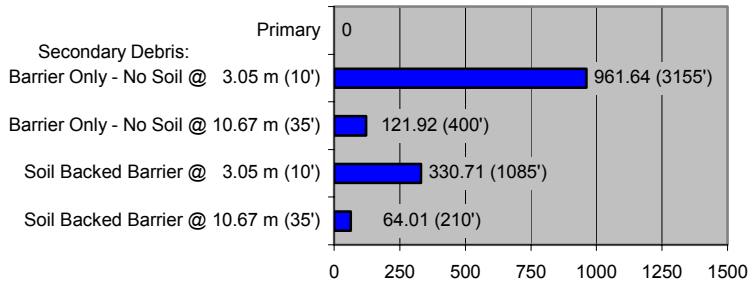

Debris Hazard Distance

Charge Weight: High **Barrier Type: Earthen**

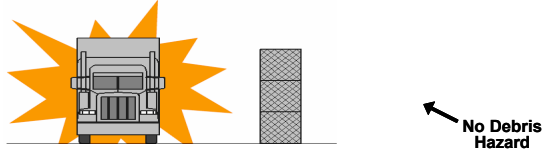

“NO HAZARDOUS DEBRIS”

Required Dimensions:	Base in	Height in	Top in
	meters (feet)	meters (feet)	meters (feet)
Earth Berm	3.66 (12)	3.66 (12)	0.61 (2)
Hesco Bastion	2.44 (8)	3.66 (12)	2.44 (8)
Sandbags	2.44 (8)	3.66 (12)	0.61 (2)

FIXED STRUCTURES

Blast/Frag Mitigation Plan

The purpose of this section is to describe the implementation techniques for retrofit devices that may be employed to reduce secondary fragmentation in buildings. Secondary fragments in buildings consist of glass shards and wall debris. Recommended applications of window film retrofits and geotextile and reinforced concrete wall backing retrofits and associated safe distances for those retrofits are included in the low, medium and high explosive threat charts below. Secondary debris in structures is generated solely by explosive load from the LVB. Primary or secondary debris from the ECP does not impact secondary debris generation in buildings, and does not determine safe standoff. Window replacement with laminated glass and structural hardening remain as options for further fixed structure improvement.

The “Safe Distance” described in the charts below is the minimum standoff distance required for the given explosive threat condition of a typically constructed, steel or concrete framed building with CMU infill walls, using the window or wall retrofit types specified. Standoff values with and without blast walls at the protected building are included. Standoff for wall retrofits ignores window damage, and refers to minimum distance to prevent wall damage. The top standoff distance on each chart allows comparison to the wall with no retrofit installed. Details for wall retrofits and “catcher bar” installation are included in Endnotes 4 and 5.

REMEMBER: To correctly assess safe standoff for fixed structures, both the fixed structure wall and the fixed structure window charts must be referenced.

FOR OFFICIAL USE ONLY

Fixed Structure Wall Safe Distances
Charge Weight: Low **Blast Wall: No**

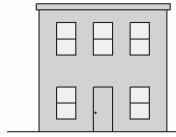

CMU Wall Damage - No Blast Wall
Meter (ft)

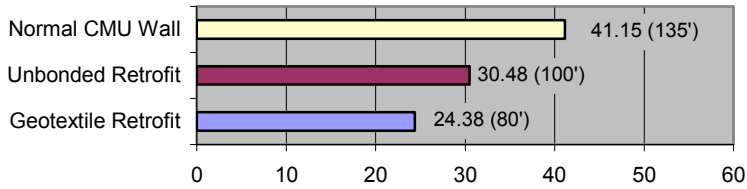

Fixed Structure Wall Safe Distances
Charge Weight: Low **Blast Wall: Yes**

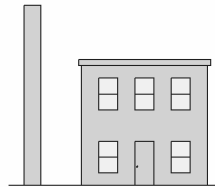

CMU Wall Damage - With Blast Wall
Meter (ft)

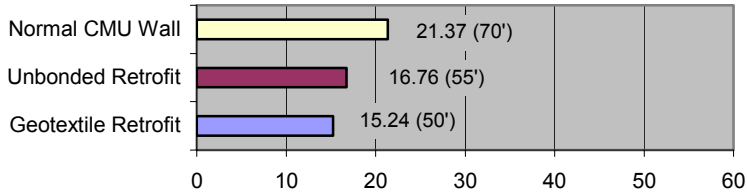

FOR OFFICIAL USE ONLY

Fixed Structure Wall Safe Distances
Charge Weight: Medium **Blast Wall: No**



CMU Wall Damage - No Blast Wall
Meter (ft)

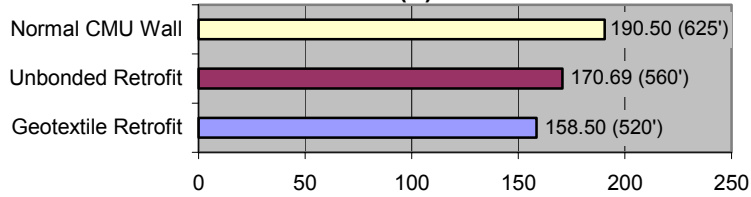

Fixed Structure Wall Safe Distances
Charge Weight: Medium **Blast Wall: Yes**

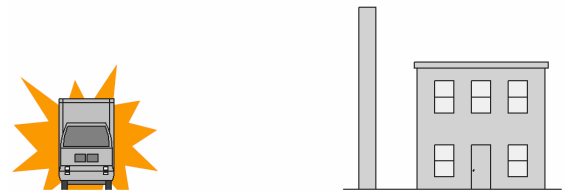

CMU Wall Damage - With Blast Wall
Meter (ft)

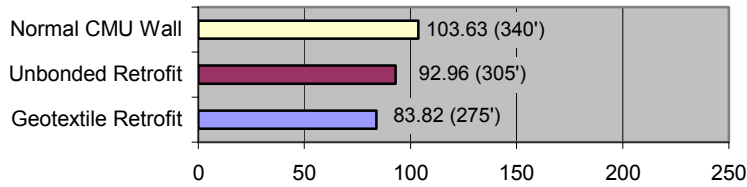

FOR OFFICIAL USE ONLY

Fixed Structure Wall Safe Distances
Charge Weight: High **Blast Wall: No**



CMU Wall Damage - No Blast Wall
Meter (ft)

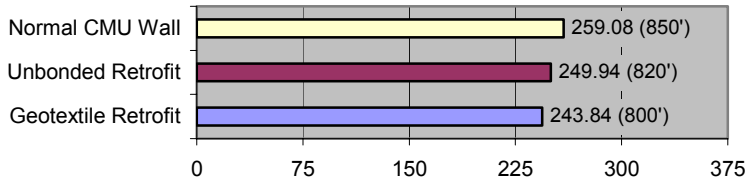

Fixed Structure Wall Safe Distances
Charge Weight: High **Blast Wall: Yes**

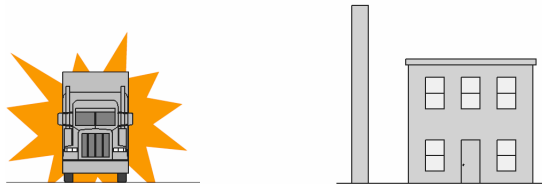

CMU Wall Damage - With Blast Wall
Meter (ft)

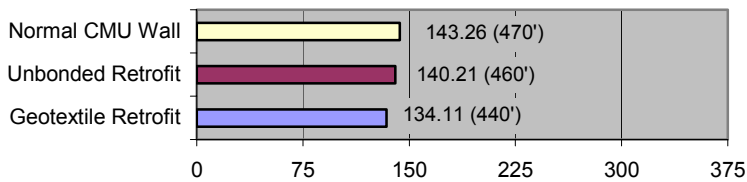

FOR OFFICIAL USE ONLY

Fixed Structure Window Safe Distances
Charge Weight: Low **Blast Wall: No**

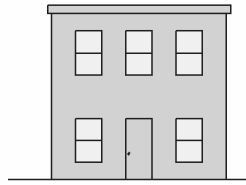

609.60 mm x 914.40 mm (24" x 36") Window Hazard
Distances in Meters (ft) - No Blast Wall

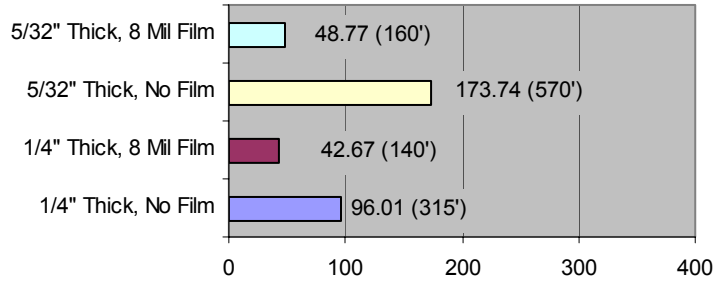

1,219.20 mm x 1,524 mm (48" x 60") Window Hazard
Distances in Meters (ft) - No Blast Wall

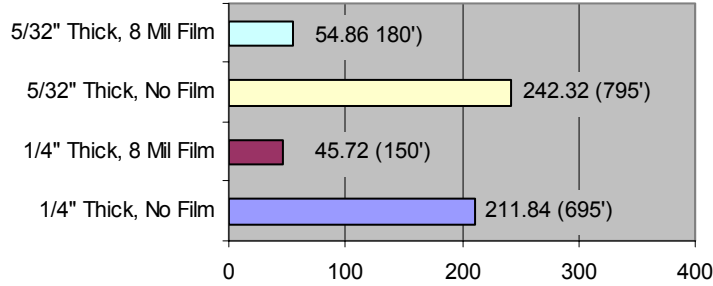

FOR OFFICIAL USE ONLY

Fixed Structure Window Safe Distances
Charge Weight: Low **Blast Wall: Yes**

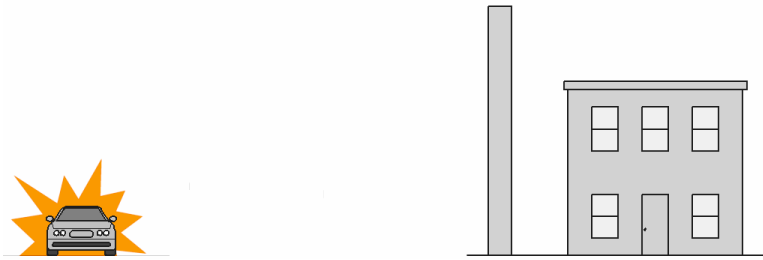

609.60 mm x 914.40 mm (24" x 36") Window Hazard
Distances in Meters (ft) - With Blast Wall

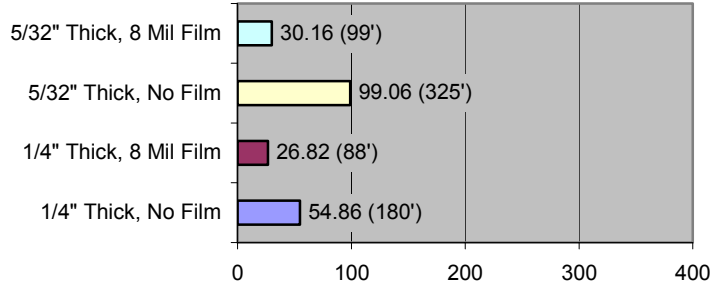

1219.20 mm x 1524 mm (48" x 60") Window Hazard
Distances in Meters (ft) - With Blast Wall

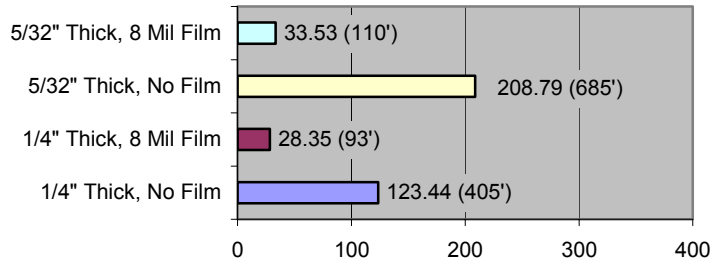

FOR OFFICIAL USE ONLY

Fixed Structure Window Safe Distances
Charge Weight: Medium Blast Wall: No

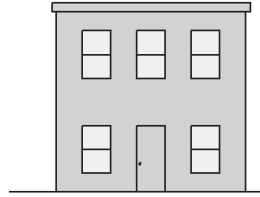
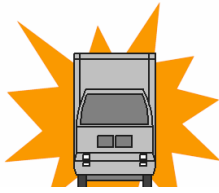

609.60 mm x 914.40 mm (24" x 36") Window Hazard
Distances in Meters (ft) - No Blast Wall

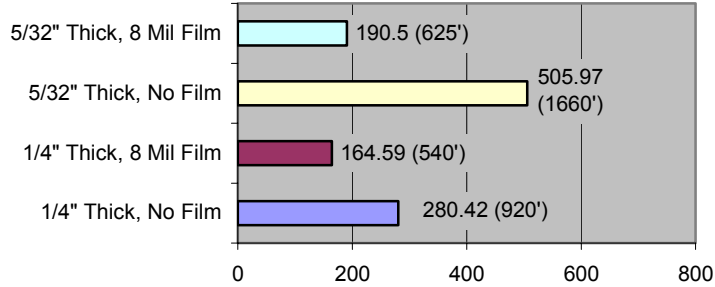

1219.20 mm x 1524 mm (48" x 60") Window Hazard
Distances in Meters (ft) - No Blast Wall

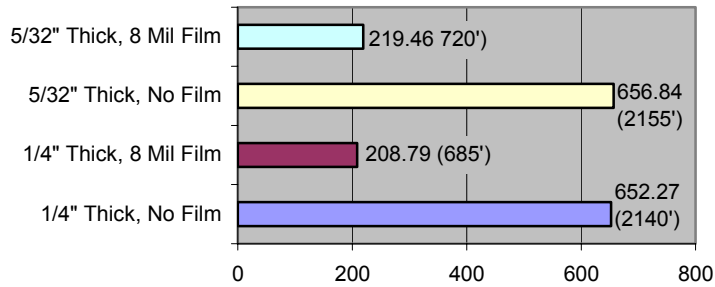

FOR OFFICIAL USE ONLY

Fixed Structure Window Safe Distances
Charge Weight: Medium Blast Wall: Yes

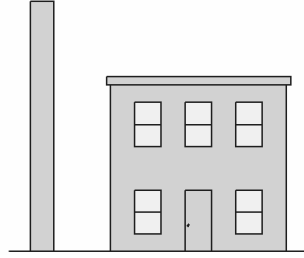

609.60 mm x 914.40 mm (24" x 36") Window Hazard
Distances in Meters (ft) - With Blast Wall

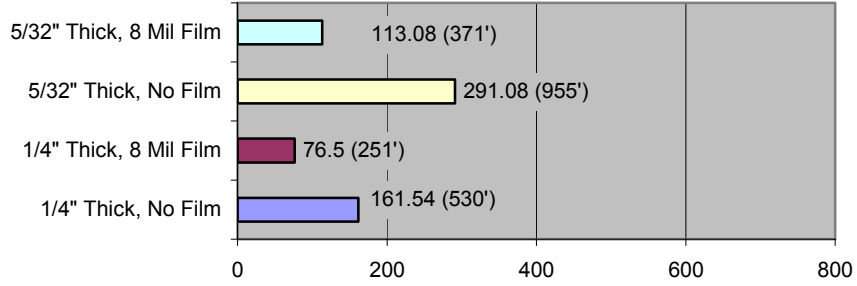

1219.20 mm x 1524 mm (48" x 60") Window Hazard
Distances in Meters (ft) - With Blast Wall

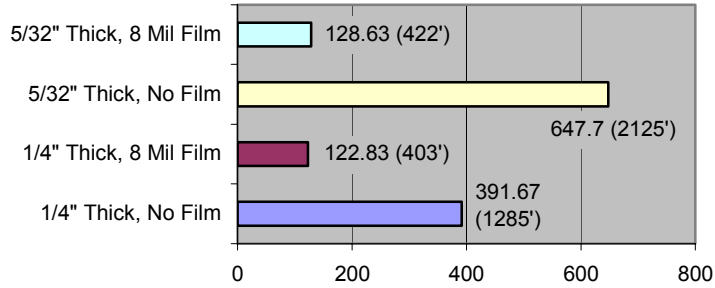

FOR OFFICIAL USE ONLY

Fixed Structure Window Safe Distances
Charge Weight: High **Blast Wall: No**



609.60 mm x 914.40 mm (24" x 36") Window Hazard
Distances in Meters (ft) - No Blast Wall

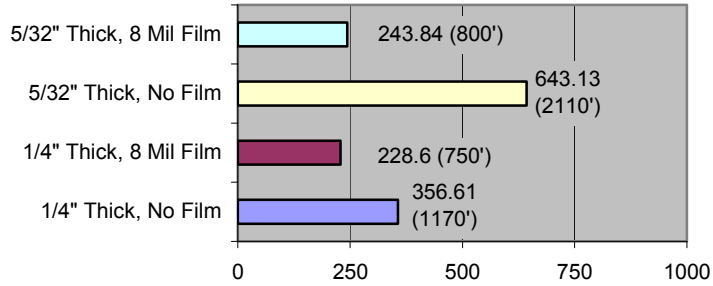

1219.20 mm x 1524 mm (48" x 60") Window Hazard
Distances in Meters (ft) - No Blast Wall

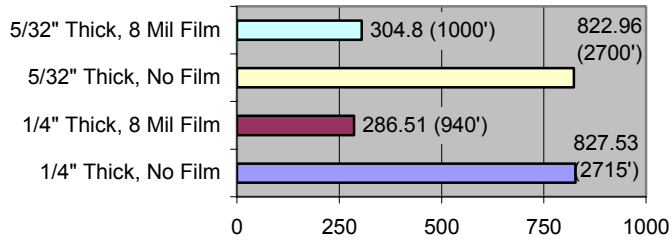

FOR OFFICIAL USE ONLY

Fixed Structure Window Safe Distances
Charge Weight: High **Blast Wall: Yes**

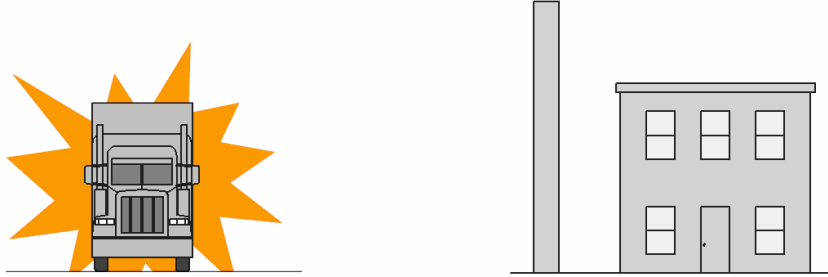

609.60 mm x 914.40 mm (24" x 36") Window Hazard
Distances in Meters (ft) - With Blast Wall

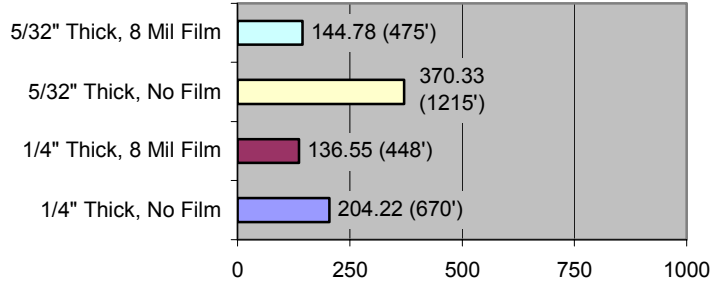

1219.20 mm x 1524 mm (48" x 60") Window Hazard
Distances in Meters (ft) - With Blast Wall

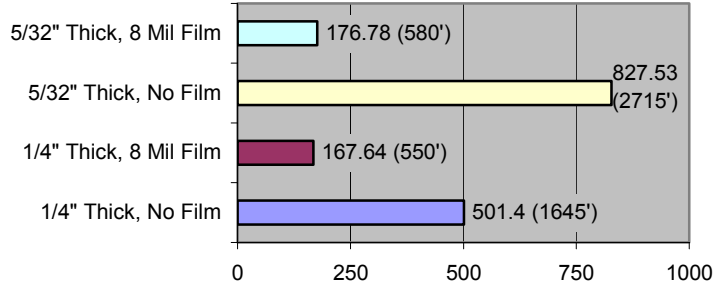

FOR OFFICIAL USE ONLY

EXPEDITIONARY STRUCTURES

Blast/Frag Mitigation Plan

The purpose of this section is to establish safe siting distances for expeditionary structures, including Temporary Personnel (TEMPER) tents, trailers and other expedient shelters such as General Purpose (GP) Shelters¹⁰.

Primary fragments, secondary fragments and explosive loads in the far field threaten shelters and other expeditionary structures. Primary fragments in the near field and primary and secondary fragments in the far field can be mitigated with barriers (Jersey, Bitburg, concertainer, soil filled.) The charts below present safe siting distances for the two scenarios of unprotected and protected ECP's for TEMPER Tents, trailers and other shelters (GPS and Kabins).

The following recommendations are made to optimize the blast and fragment mitigation measures for shelters. Safe distances with and without blast walls are provided. Blast walls at the structure reduce blast loads (although the degree of damage may not be significantly less than an unprotected shelter) and provide protection from primary and secondary debris.

FOR OFFICIAL USE ONLY

Expeditionary Structure Safe Distances
Charge Weight: Low **Blast Wall: No**

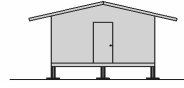

Expeditionary Structure Damage - No Blast Wall
Meter (ft)

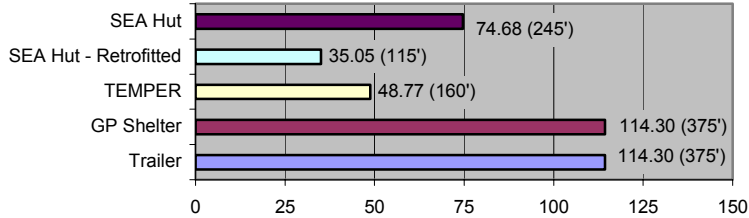

Expeditionary Structure Safe Distances
Charge Weight: Low **Blast Wall: Yes**

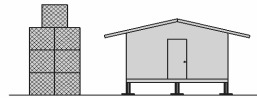

Expeditionary Structure Damage - With Blast Wall
Meter (ft)

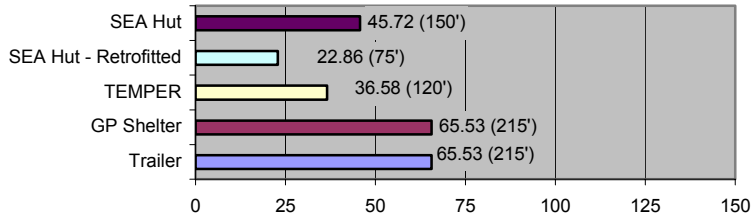

FOR OFFICIAL USE ONLY

Expeditionary Structure Safe Distances
Charge Weight: Medium **Blast Wall: No**

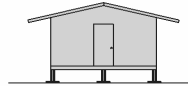

Expeditionary Structure Damage - No Blast Wall
Meter (ft)

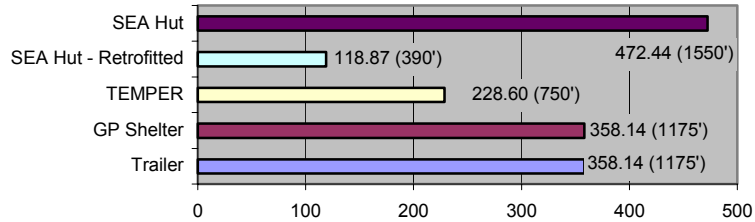

Expeditionary Structure Safe Distances
Charge Weight: Medium **Blast Wall: Yes**

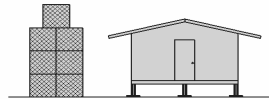

Expeditionary Structure Damage - With Blast Wall
Meter (ft)

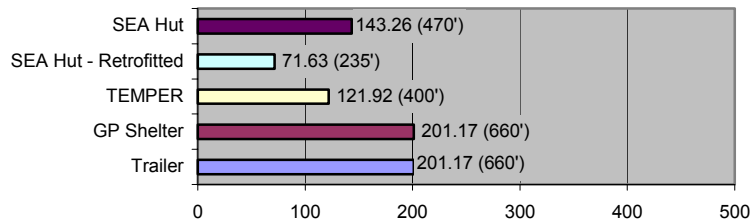

FOR OFFICIAL USE ONLY

Expeditionary Structure Safe Distances
Charge Weight: High **Blast Wall: No**

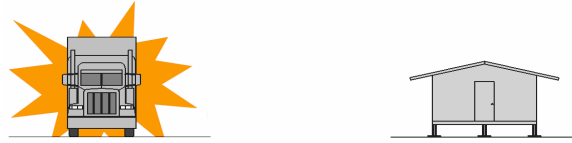

Expeditionary Structure Damage - No Blast Wall
Meter (ft)

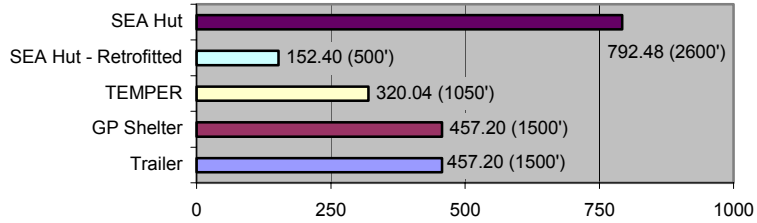

Expeditionary Structure Safe Distances
Charge Weight: High **Blast Wall: Yes**

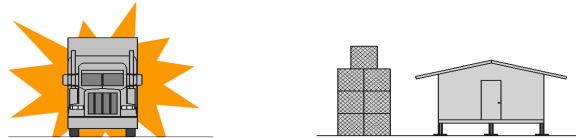

Expeditionary Structure Damage - With Blast Wall
Meter (ft)

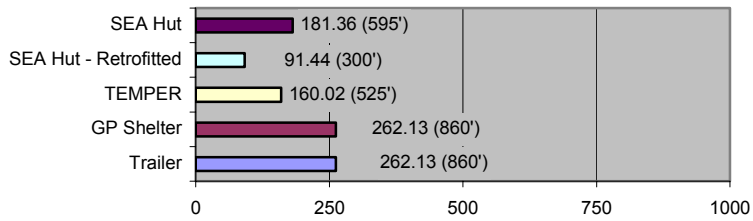

FOR OFFICIAL USE ONLY

KEY POINTS FOR COMMANDERS

All principles, systems, and processes pertinent to protecting against vehicle bombs should be used in concert with one another.

HISTORICAL TRENDS

Vehicle bombs are the most successful tactic employed by terrorists to inflict personnel casualties and property damage. They will continue to be used due to the wide availability of bulk explosives, along with the ease with which they are concealed and introduced to a target environment. We cannot afford to become complacent...the fact is, we will always need to defend against this type of threat!

EXPLOSIVES DETECTION

The systems approach is simple...*layer* and *tailor* technology along with traditional vehicle search techniques according to three key factors: 1) Your site specific threat, 2) The resources you have available, and 3) Your operating environment, to include the standoff available between an Entry Control Point and critical assets.

The optimum "generic mix" of traditional vehicle search techniques and explosives detection technology is: 1) A Military Working Dog and Handler – "putting nose on target", 2) A Security Forces member doing a physical inspection – "putting eyes on target", and 3) Some form of explosives trace detection technology – "putting technology on target."

FOR OFFICIAL USE ONLY

BLAST AND FRAGMENT MITIGATION

The best protection is standoff! Do whatever is necessary to achieve all the standoff that you can! Remember that barriers at the detonation point are better at mitigating fragments than they are at mitigating blast. In fact, nothing sufficiently mitigates blast damage to expeditionary shelters except standoff...and every small distance helps! Recall that concrete barriers must be used with the right mindset – countermobility. If they are used in close proximity to entry control areas they MUST be soil-backed to avoid creating secondary fragmentation hazards.

FOR OFFICIAL USE ONLY

ANNEX**Annex A – Glossary**

Abbreviation	Meaning
ACM	Access Control Monitor
AN	Ammonium Nitrate
ANFO	Ammonium Nitrate/Fuel Oil
AOR	Area of Responsibility
ASTM	American Society for Testing and Materials
ATD	anthropomorphic test dummy
BAIT	Blast and Airman Injury Test
BASS	Barrier Assessment for Safe Standoff
BMAG	Blast Mitigation Action Group
C4	Composition C-4
CMU	concrete masonry unit
COE	Corps of Engineers
CP	command post
DDESB	Department of Defense Explosives Safety Board
Det Cord	Detonation Cord
DISPRE	Debris Dispersion Prediction
DM	DiPole Migt
DoD	Department of Defense
DOE	Department of Energy
DoS	Department of State
ECP	entry control points
EDD	Explosive Detector Dog
EOD	Explosive Ordnance Disposal
ETL	Engineering Technical Letter
FOUO	For Official Use Only
FPB	Force Protection Battlelab
FRF	fragment retention film
HE	high explosives

FOR OFFICIAL USE ONLY

Abbreviation	Meaning
IED	Improvised Explosive Device
Ion Scan	Explosive trace detector
IR	infrared
LVB	large vehicle bomb
MWD	military working dogs
NAVEODTECHDIV	Naval Explosive Ordnance Disposal Technology Division
NCN	Nitro-Carbo-Nitrate
PETN	Pentaerythritol tetranitrate
R&D	Research and Development
RC	remote control
RDX	Rapid Detonating Explosive
RODS	Retrofit and Overpressure Design of Shelters
SEA Hut	Southeast Asia Hut
SSS	Small Shelter System
SWH	scaled wall height
TEMPER	Tent, Extendable, Modular PERSONnel
TM	Technical Manual
TNT	Trinitrotoluene
UFC	Unified Facilities Criteria
US	United States
USAF	United States Air Force
UVSS	Under Vehicle Surveillance System
VACIS	Vehicle and Cargo Inspection Station
VB	vehicle bomb
VBMG	Vehicle Bomb Mitigation Guide
VEESS	Vehicle Entry Explosive Search Strategy
Visual	Security Forces member
WES	Waterways Experimental Station

FOR OFFICIAL USE ONLY

Annex B – Glossary

Anti-Terrorism Defensive measures used to reduce the vulnerability of people and property to terrorist acts.

Base Charge The explosive (normally RDX or PETN in non-electric and electric blasting caps; and usually an ignition mixture in electric squibs) that ultimately initiates the booster or main charge.

Blast Barrier Employed near the LVB (at the ECP) and can attenuate blast in their “shadow” to levels acceptable for hardened structures. Blast barriers do not reduce blast damage significantly for conventional and expeditionary structures, and as such, they are incorrectly implemented to mitigate blast effects.

Blast Curtains Heavy curtains made of blast resistant materials that could protect the occupants of a room from flying debris.

Blast Directing Technique The focusing of an explosive wave towards the intended target in an attempt to create more damage.

Blast Effects Destructive results to assets due to an explosive blast.

Blast Mitigation Refers, in a general sense, to the various physical measures that can be employed to lessen the damage of a blast wave on critical assets. These measures can include, but are not limited to, things like blast walls, blast barriers, standoff, structural hardening, retrofitting, etc.

Blast The force of an explosion as it is transmitted through the air (blast) can cause injury to personnel in the open; it can pick up and translate ground debris, and can fail and collapse structures, generating numerous injuries and deaths.

Blast Wall Protective walls employed at an occupied position (such as a building) that are designed to reduce reflected pressures to incident pressures on vertical surfaces.

Blasting Cap Device used to initiate a primary explosive. May be electric or non-electric.

Booster Explosive The booster explosive amplifies the detonation wave of the blasting cap in order to initiate the rather insensitive ANFO main-charge.

FOR OFFICIAL USE ONLY

Breach Occurs when brittle materials like concrete are destroyed through the thickness by very intense and local overpressure, resulting in a hole.

Countermobility Physical barriers or soil-backed barriers used to direct, channel, or prohibit vehicle traffic to a predefined course of entry or exit.

Detonating Cord (Det Cord) A flexible cord containing a center core of an explosive compound such as RDX or PETN that is protected from the elements by a waterproofing sheath. Det cord effectively transmits the detonation wave to the main or booster charge. Det cord can be amplified or “sensitized” by adding a non-electric-blasting cap to ensure initiation of the less sensitive main or booster charge.

Detonators Used to detonate the main charge. Detonator is another word for non-electric and electric blasting caps, electric squibs, and even improvised initiation devices.

Domestic Terrorism Terrorism perpetrated by the citizens of one country against fellow countrymen. That includes acts against citizens of a second country when they are in the host country, and not the principal or intended target.

Explosive Ordnance Disposal (EOD) The detection, identification, field evaluation, rendering safe, recovery, evacuation, and disposal of explosive military ordnance and improvised explosive devices that present a threat to operations, installations, personnel, or material. EOD is carried out by U.S. military EOD technicians, who are specially trained and equipped for such a mission.

Far Field Generally refers to relatively low overpressures found at greater distances from the detonation point.

First Responders Military or civilian forces normally first at an incident scene. Examples are: Security Forces (civilian police), Explosive Ordnance Disposal—EOD (civilian bomb squad), Fire Fighters, and Emergency Medical Technicians—EMTs.

Force Protection The protection of personnel and equipment in all locations and situations. This is accomplished through the planned integration of combating terrorism, physical security, information

FOR OFFICIAL USE ONLY

operations, high-risk personnel security, and law enforcement operations; all supported by foreign intelligence, counterintelligence, and other security programs. Force Protection also includes safety awareness both on and off duty.

Fragment Barrier Employed near the LVB (at the ECP) and in the far field near occupied positions to provide protection from impacting primary debris from the LVB and secondary debris (ECP barrier debris).

Fragment Mitigation Refers, in a general sense, to the various physical measures that can be employed to lessen the damage of fragments on critical assets. These measures can include, but are not limited to, things like earth barriers at the detonation point, standoff, sandbags at the asset, etc.

Hardened Facilities Facilities or structures that are modified to provide protection from blast.

High Explosive Note that “high” does not refer to an explosive’s sensitivity...it simply refers to the fact that a high explosive detonates.

Improvised Explosive Device (IED) Any device fabricated in an improvised manner, incorporating explosives, or destructive, lethal, noxious, pyrotechnic, or incendiary chemicals, designed to destroy, disfigure, distract, or harass. Typical examples include pipe bombs.

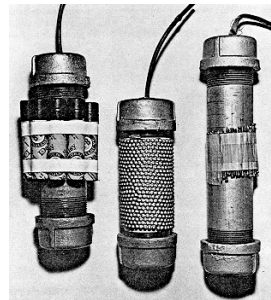

Incident Pressure The pressure of the blast wave out in the open before it hits a reflective surface.

Layered The method in which protective measures are employed in order to counter the vehicle bomb threat. i.e. Utilizing different detect schemes at sequential search stations.

Low Explosive A low explosive deflagrates (burning with great intensity and light); however, when confined, as in a pipe bomb, a low explosive will detonate.

FOR OFFICIAL USE ONLY

Main-Charge The explosive present in the greatest amount, relied upon to do the work of the bomb, be it a terrorist vehicle bomb or a military ordnance item.

Near Field Refers to the area immediately surrounding a detonation in which blast and fragment damage will be extensive.

Nuclear, Biological or Chemical Weapons (NBC) Also called Weapons of Mass Destruction (WMD), these are weapons that are characterized by their capability to produce mass casualties.

Overpressure Another name for blast.

Physical Security The part of security concerned with measures/concepts designed to safeguard personnel; to prevent unauthorized access to equipment, installations, materiel, and documents; and to safeguard them against espionage, sabotage, damage, and theft.

Primary Fragments Parts, pieces, and fragments of the vehicle and bomb that are thrown outward from the detonation at high velocity. Primary fragments are generally the most lethal projectiles from a bomb detonation.

Reflected Pressure The pressure of the blast wave that occurs when it impacts a wall or other stationary vertical surface.

Sacrificial Roof or Wall Walls or roofs that can be lost in a blast without damage to the primary asset.

Safety Fuse Flexible and weatherproof sheath containing black powder. Used to transmit flame, at a continuous and uniform rate (usually, approximately 137.80 seconds per meter (42 seconds per foot)), to initiate non-electric blasting caps.

Secondary Debris Debris from failing barriers, ECP structures, and buildings (walls and glass) caused by the blast.

Secondary Fragments This occurs when objects surrounding a detonation become projectiles and fragments with enough energy to create damage of their own.

Sensitivity Refers to the amount of external force or energy needed to cause detonation.

Spall Occurs when fragments are dislodged at high velocities from the backside of a brittle material like concrete.

FOR OFFICIAL USE ONLY

Squib Used to electrically initiate low explosives through an ignition charge activated by an electric filament (or bridge wire).

Stable Characteristic of an explosive to resist detonation or deterioration under normal storage conditions.

Standoff The distance between the detonation point and the asset.

Standoff Distance The distance between an asset and a threat.

Standoff Weapons Weapons that are launched from a distance at a target (anti-tank weapons, mortars, etc.).

Systems Approach A method of operation that calls for an “all encompassing” mindset. Knowing what effect changes to one “system” have on all independent yet, linked systems.

Tailored Making the guidance provided in this guide fit your specific needs. Addressing your location specific threat, resource availability, and operational environment when deciding on explosives detection schemes and/or blast and fragment mitigation.

Threat Analysis In antiterrorism, threat analysis is a continual process of compiling and examining all available information concerning potential terrorist activities by terrorist groups that could target a facility. A threat analysis will review the factors of a terrorist group’s existence, capability, intentions, history, and targeting, as well as the security environment within which friendly forces operate. Threat analysis is an essential step in identifying probability of terrorist attack and results in a threat assessment. See also anti-terrorism.

Timers Used to initiate Improvised Explosive Devices (IEDs) at certain delay settings, from minutes, to hours, to days and even months. Timers can be mechanical, electrical, or chemical.

FOR OFFICIAL USE ONLY

Annex C – Federal Government POC’s

C-1 On-Scene Response/Consultation

ORGANIZATION	24-HOUR PHONE NUMBER	24-HOUR FAX NUMBER
Department of Energy	(202) 586-8100	(202) 586-8485
Department of State Operations Center	(202) 647-1512	(202) 647-0122
FEMA National Emergency Coordination Center (NECC)	(540)542-6100 1-800-634-7084	(540)665-6175
Joint Nuclear Accident Coordinating Center (JNACC)	(703) 325-2102	(703)325-0146
United States Postal Service	(202) 268-2000	(202) 268-5211
USAF Operations Center	(703) 697-6103	(703) 695-9673
Bureau of Alcohol, Tobacco, Firearms and Explosives (ATF) National Response Team Primary Federal Response to Explosive and Arson Post Event Scenes Department of Justice	1-800-800-3855	N/A

C-2 Research Assistance

ORG.	Contact Information	Technology	
		Explosive Detection	Blast Mitigation
Department of Energy	Sandia National Laboratories Security and Safeguards Systems Access Denial Technology Division PO Box 5800 (Mailstop-0783) Albuquerque, NM 87185-0783 (505) 845-8149 (Primary) (505) 845-7489 (Alternate) (505) 844-5569 (Fax)	✓	
Department of Transportation	Department of Transportation Office of Security/Office of the Secretary MS-70 Room 7402 400 7 th Street, SW Washington, D.C. 20590 (202) 366-4677 (Primary) (202) 366-7013 (Fax)	✓	✓

FOR OFFICIAL USE ONLY

ORG.	Contact Information	Technology	
		Explosive Detection	Blast Mitigation
Federal Aviation Administration	Federal Aviation Administration Office of Policy and Planning 800 Independence Avenue, SW, Rm 939W Washington, D.C. 20591 (202) 267-3274 (Primary) (202) 267-3278 (Fax)	✓	✓
Transportation Security Administration	Transportation Security Administration Explosives Unit 800 Independence Avenue, SW, Room 306 Washington, D.C. 20591 (202) 267-8259 (Primary) (202) 493-4263 (Fax)	✓	✓
Department of Defense	Defense Threat Reduction Agency (DTRA) Weapons Effects Directorate 6801 Telegraph Road Alexandria, VA 22310-3398 (703) 325-7115 (Primary) (703) 325-7143 (Alternate) (703) 325-2957 (Fax)	✓	✓
US Air Force FPB	USAF Force Protection Battlelab Force Protection Concepts Division 1517 Billy Mitchell Blvd., Bldg. 954 Lackland Air Force Base, TX 78236-0119 (210) 925-5028 (Primary) (210) 925-1440 (Alternate) (210) 925-5415 (Fax)	✓	✓
US Air Force AFCESA	Air Force Civil Engineering Support Agency 139 Barnes Dr., Suite 1 Tyndall AFB, FL 32043 (850) 283-6470 (Primary) (850) 283-6219 (Fax)		✓
US Navy	Naval Facilities Engineering Service Center Security Engineering Division (ESC66) 1100 23 rd Avenue Port Hueneme, CA 93043-4370 (805) 982-4817 (Primary) 1-866-892-9753 (Alternate) (805) 982-1253 (Fax)		✓
US Army	US Army Corps of Engineers Protective Design Center (CENWO-ED-S) 1265 W. Center Road Omaha, NE 68144-3869 (402) 221-4371 (Primary) (402) 221-4315 (Fax)		✓

FOR OFFICIAL USE ONLY

Annex D – References

WORKS REFERENCED IN PREPARATION OF THIS GUIDE

- AFI 31-302, Military Working Dog Program, 1 August 1996.
- AFM 31-219, USAF Military Working Dog (MWD) Program, 1 October 1996.
- Air Force Operational Test and Evaluation Center, Detachment 1 (1998). Demonstration Execution Document: Vehicle Entry Explosives Search Strategy. Kirtland AFB: Albuquerque, NM.
- Air Force Operational Test and Evaluation Center, Detachment 2 (1997). Under-vehicle Inspection Operational Utility Evaluation Final Report. Eglin AFB, FL.
- Applied Research Associates, Inc. (2001). Barrier Assessment for Safe Standoff (BASS) After Initiative Report. USAF Force Protection Battlelab, Lackland AFB, TX.
- Applied Research Associates, Inc. (2001). Blast and Airman Injury Test (BAIT) After Initiative Report. USAF Force Protection Battlelab, Lackland AFB, TX.
- Applied Research Associates, Inc. (2001). Retrofit and Overpressure Design of Shelters (RODS) After Initiative Report. USAF Force Protection Battlelab, Lackland AFB, TX.
- Applied Research Associates, Inc. (2001). BAIT, BASS, and RODS Webpendix – 4 CD set: Main Appendix, Test 0 – 7 Video Appendix, Test 8 – 14 Video Appendix, and Anthro-Bio Appendix. USAF Force Protection Battlelab, Lackland AFB, TX.
- Frank, M. et al. (1997). Results of Explosive Detection Research in Support of Portable Explosive Detection. Naval Explosive Ordnance Disposal Technology Division Technical Report #TR-327. NAVEODTECHDIV: Indian Head, MD.

FOR OFFICIAL USE ONLY

- Johnston, J. M. and Hartell, M. G. (1997). Canine Olfactory Sensitivity to a Selected Nitroglycerin-Based Smokeless Powder. U.S. Department of the Treasury Report # TSS-92-16. Institute for Biological Detection Systems: Auburn University, AL.
- Johnston, J. M. and Myers, L. J. (1994). Survey and Analysis of Selected Detection Dog Training Programs. U. S. Department of the Treasury Report # 92-3268. Institute for Biological Detection Systems: Auburn University, AL.
- Nolan, R. V. and Gravitte, D. L. (1977). Mine-Detecting Canines. U.S. Army Mobility Equipment Research and Development Command Report #2217. MERADCOM: Ft. Belvoir, VA.
- Office of Special Technology (1998). Vehicle Screening Security Technology Demonstration at the Administrative Support Unit, Southwest Asia. TSWG Final Report No. T-149A. Tracor: Rockville, MD.
- Powell, L. et al. (1998). Combined Explosives Detection Technology Assessment. Draft Final Report No. DOT/FAA/AR-98/XX. Federal Aviation Administration William J. Hughes Technical Center: Atlantic City, NJ.
- Rouhi, A. Maureen. "Detecting Illegal Substances." Chemical & Engineering News, 29 Sep 97.
- Smith, B. (1994). Terrorism in America: Pipe Bombs and Pipe Dreams. State University of New York Press: Albany, NY.
- Terrorist Research and Analytical Center, FBI (1984). "FBI Analysis of Terrorist Incidents in the United States – 1982." Terrorism: An International Journal. 7:1. 87-117.
- (1989). Terrorism in the United States: 1989. U.S. Government Printing Office: Washington, DC.

FOR OFFICIAL USE ONLY

FEDERAL

- Director of Central Intelligence, Interagency Intelligence Committee on Terrorism, Community Counterterrorism Board, Improvised Explosive Devices: A Basic Reference, June 1997 (Limited Official Use).
- GSA Security Criteria, Final Working Version 17 June 1997 (Limited Official Use).
- U.S. Department of State, Bureau of Diplomatic Security, Structural Engineering Guidelines for New Embassy Office Buildings, August 1995 (Limited Official Use).
- U.S. Department of State, Bureau of Diplomatic Security, Physical Security Standards Handbook, 7 January 1988 (Limited Official Use).

DEPARTMENT OF DEFENSE

- DoD Directive 2000.12, DoD Combating Terrorism Program, 15 September 1996
- DoD Instruction 2000.16, DoD Combating Terrorism Program Standards, 21 July 1997
- DoD Instruction 2000.14, DoD Combating Terrorism Program Procedures, 15 June 1994
- DoD Instruction 4270.1, Planning, Design, Engineering, and Construction of Facilities, August 1997 [draft] (Replaces MIL-HDBK 1190, Facility Planning and Design Guide)
- DoD O-2000.12-H, Protection of DoD Personnel and Activities Against Acts of Terrorism and Political Turbulence: Mandatory Standards and Implementing Guidance, February 1993, with change 1 dated 21 May 1993 and change 2 dated 21 July 1997
- DoD 5200.1R, DoD Information Security Program Regulation
- DoD 5200.8R, Physical Security Program Regulation
- DoD Report to the President: The Protection of U.S. Forces Deployed Abroad, 15 September 1996

FOR OFFICIAL USE ONLY

- DoD Unified Facilities Criteria (UFC) 4-101-10 and 4-010-01, DoD Minimum Antiterrorism Standoff Distance for Buildings, FOUO, 21 September 2002
- FM 5-114, Engineer Operations Short of War
- FM 100-37, Terrorism Counteraction, 1987
- MIL-HDBK 1013/1A, Design Guidelines for Physical Security of Fixed Land-Based Facilities, October 1987
- Naval Civil Engineering Laboratory (NCEL), Terrorist Vehicle Bomb Survivability Manual (Vehicle Barriers), March 1986
- Remarks by General John M. Shalikashvili, Chairman, Joint Chiefs of Staff, to the Joint Staff and Defense Special Weapons Agency, Force Protection Symposium, 19 November 1996
- TM 5-853 Vol 4, Security Engineering, Electronic Security Systems, 12 May 1994
- UG-2030-SHR, User's Guide on Security Glazing Applications, Naval Facilities Engineering Service Center. Security Engineering Division (ESC66): Port Hueneme, CA. May 1998.
- UG-2031-SHR, User's Guide on Protection Against Terrorist Vehicle Bombs, Naval Facilities Engineering Service Center. Security Engineering Division (ESC66): Port Hueneme, CA. May 1998.
- Wright Laboratory Report, Expedient Hardening Methods for Structures Subjected to the Effect of Nonnuclear Munitions, October 1990
- AIR FORCE**
- AFH 10-222, Vol 3, Guide to Civil Engineer Force Protection, 1 June 1997
- AFH 31-223, The Air Force Resource Protection Program, February 1997
- AFH 32-1084, Standard Facility Requirements Handbook, July 1994
- AFI 31-101, Vol 1, The Air Force Physical Security Program, December 1996

FOR OFFICIAL USE ONLY

AFI 31-209, The Air Force Resource Protection Program, 10 November 1994

AFI 31-210, The Air Force Antiterrorism (AT) Program, 1 July 1995

AFI 32-1021, Planning and Programming of Facility Construction Projects, May 1994

AFI 32-1024, Standard Facility Requirements, 31 May 1994

AFI 32-1032, Planning and Programming Real Property Maintenance Projects Using Appropriated Funds (APF), May 1994

AFI 32-7062, Air Force Comprehensive Planning, April 1994

AFMAN 32-1055, Design and Analysis of Hardened Structures to Conventional Weapons Effect, April 1997 [draft]

AFMAN 32-1071, Vol 1, Security Engineering Project Development, 12 May 1994

AFMAN 32-1071, Vol 2, Security Engineering Concept Design, 12 May 1994

AFMAN 32-1071, Vol 3, Security Engineering Final Design, 12 May 1994

AMC Flightline Security Standards, April 1996

AMC Passenger Terminal Design Guide [draft]

Air Force Office of the Civil Engineer memo, Anti-terrorism (AT) Protective Features for Facilities and Installations, 2 December 1996

Air Force Office of the Civil Engineer pamphlet, Installation Force Protection Guide, December 1997

Area Development Planning Bulletin, October 1991

Base Comprehensive Planning Handbook, Planning Airbases for Combat Effectiveness, December 1993

Entry Control Facilities Design Guide, Draft, 18 February 2003

ETL 86-10, Antiterrorism Planning and Design Guidance, 13 June 1986

ETL 90-3, TEMPEST Protection for Facilities, 23 March 1990

ETL 91-2, High Altitude Electromagnetic Pulse, 4 March 1997

FOR OFFICIAL USE ONLY

Annex E – Feedback/Suggestion Page

Organization: _____

Phone: DSN _____

Commercial _____

Address: _____

1. General comments on the guide:

2. Specific tactic, concept, or equipment that should be added to the guide:

Mail or FAX form to:

USAF Force Protection Battlelab
ATTN: Civil Engineering Officer
1517 Billy Mitchell Blvd, Bldg 954
Lackland AFB, TX 78236-0119
COMM: (210) 925-5028, DSN: 945-5028
FAX: (210) 925-5415, DSN: 945-5415

Email: FPBattlelab@lackland.af.mil

FOR OFFICIAL USE ONLY

ENDNOTES

¹ The USAF Force Protection Battlelab conducted a field experiment in late 1998 to determine among other objectives, the general detection capabilities of Explosive Detector Dogs (EDDs) in an actual operational setting against realistic Vehicle IEDs. In this experiment, the EDDs used demonstrated an average detection frequency of 66%, and a false alarm rate of approximately 5%. The detection frequency varied somewhat according to the size of the IED in question. However, initial indications from the experiment suggested that the dogs are quite agile students, able to "learn" new explosives sizes very quickly. Unfortunately, there is much additional research required before the issue of quantity impacts of detection capability will be fully understood.

² Because of the difficulty of controlling and measuring odor stimuli under non-laboratory conditions, it is likely not possible to collect similar data in the field. There are a number of potential sources of variation between laboratory and field conditions, including dog search technique timing, training history, handler skills, and visual/auditory/nontarget olfactory stimuli interferences (Johnston and Hartell 1997: 28).

- During a U.S. Army field test of canine mine detection capabilities, although the dogs correctly alerted at a much higher rate than they incorrectly alerted, the raw number of false alerts was approximately 25% greater than the raw number of correct alerts.

- Potential causes hypothesized by the researchers included unknown previous contamination resident from previous explosives tests on site, and cross-contamination of explosive odors from active to inert target mines (Nolan and Gravitte 1977: 64-66)

³ The Naval Explosive Ordnance Disposal Technology Division (NAVEODTECHDIV) conducted a variety of test and studies between 1988 and 1996 in support of portable explosive

FOR OFFICIAL USE ONLY

detector development. According to NAVEODTECHDIV, the tests support three primary conclusions:

#1: Explosive vapor detection is not a viable means of explosive detection for plastic and chlorated explosives and is unreliable for any type of explosive if the explosive is carefully packaged.

#2: Trace particle detection (that is, detection of residual sample from the surface of a suspect object) may be a more practical and reliable means of explosive detection than vapor detection, given specific operational circumstances. These required circumstances are that:

- Sufficient quantities of explosive material must be transferred from the IED to exposed and accessible surfaces;
- Such contamination must be distributed over a significant surface area, or easily locatable; and
- A sufficient sample must be readily acquired through surface wipes or air transport.

#3: It is the inability to obtain sufficient sample from hidden explosive devices that reduces the performance and limits the application of current portable explosive detection devices. *Sample acquisition, not detector sensitivity, is the critical limiting characteristic . . .* This problem applies to both vapor and particle detection (Frank et al 1997: 2-3, emphasis added).

The NAVEODTECHDIV goes on to suggest that methods to locate likely areas of contamination or to increase sampling efficiency may be particularly valuable (1997: 23). The report emphatically states that "portable hand-held trace explosive detection will see marked improvement only if the attention of the Research and Development (R&D) community shifts from detector sensitivity to sample acquisition methods and technologies." (1997: 24). This recommendation is echoed in a FAA report on Combined Explosives Detection Technologies (Powell et al. 1998: 19).

FOR OFFICIAL USE ONLY

⁴ ***Window Retrofits:***

Window retrofit and replacement data is also available on-line at the Blast Mitigation Action Group (BMAG) website; <http://bmag.nwo.usace.army.mil/>.

The retrofit method described in Corps Of Engineers (COE) draft Engineering Technical Letter (ETL) (26 October 1998) is directly applicable to standard 5/32" or 1/4" thick annealed glass windows. Criteria are provided for glazing sizes with widths varying from 12" to 60" and heights varying from 24" to 72". The existing structure must provide locations with adequate strength for the attachment of retrofit catcher bar support brackets, in addition to any direct blast load at the location.

This window retrofit method is called the daylight application FRF catcher bar system. It consists of the application of fragment retention film (FRF) along with a catcher bar at the inside face of the window. Installation of the fragment retention film is done with the window glazing remaining in place. The film is trimmed so that it just covers the exposed surface of the glazing and does not extend into the bite of the frame. The catcher bar is typically a metal bar that spans horizontally across the inside of the window at the mid-height of the glazing and is fastened to the wall on either side of the window. In the event of an explosion that blows the glazing out of its frame, the glazing remains adhered to the FRF. As the fractured glass and FRF flies toward the inside of the room it strikes the catcher bar, wraps around it and, if the film and bar are strong enough, is stopped by the catcher bar. The FRF holds the fractured glazing together as a unit. Thus, the shards of broken glass are prevented from being blown into the building and injuring the occupants.

Anchorage of the catcher bar to the existing structure will depend on the type of existing wall construction, on window size and on window arrangement. The catcher bar spans horizontally

FOR OFFICIAL USE ONLY

across the inside of the window at mid-height of the glazing. Support for the ends of the catcher bar can be provided by brackets anchored to the wall on either side of the window. It may also be fastened to vertical members that span from the floor to the ceiling. Anchorage to the wall is recommended if there is enough room and the wall is strong enough. If space or strength restrictions make attachment to the wall impractical, attachment to vertical members supported at the floor and ceiling becomes an option. In this case the floor and ceiling must have adequate strength for attachment of the vertical supports.

The design aids given in this document are for the combined system of daylight application FRF on annealed glass with a catcher bar, and are not applicable for the individual components. The design of a catcher bar includes the design of attachment brackets and anchorage as well as sizing the catcher bar cross-section. This document provides the information needed for determining FRF thickness and catcher bar cross-section. Determination of the FRF thickness is the first step. Once the thickness has been selected then the required strength of the catcher bar can be determined.

Information needed to begin the design process includes the charge weight, the standoff and the glazing size. Charge weight is the weight of TNT equivalent to the explosive threat. Standoff is the distance between the explosive charge and the window. The required window information is the width, height and thickness of the glazing. With this information the plots presented in the below chart can be used to determine the FRF thickness required. These plots are applicable for a minimum film tensile strength of 25,000 PSI, and are conservative for larger tensile strengths. The required film thickness is independent of window width. It depends only on the glazing height, glass thickness, charge weight and standoff. The plots cover three fragment retention film thicknesses (4, 8 and 12 mil) and two glazing thicknesses (5/32" and 1/4"). These figures have standoff in feet plotted on the horizontal axis and charge

FOR OFFICIAL USE ONLY

weight in pounds on the vertical axis. Each figure has three curves, one for each of the FRF thicknesses given. Go to the figure that applies to your glazing thickness and height to determine the minimum FRF thickness required. If the FRF thickness, the glazing height or the glazing thickness desired are not given in the figures the designer may interpolate between multiple curves and multiple figures. Extrapolation beyond the maximum and minimum glazing sizes in these figures is not recommended without experimental or analytical verification.

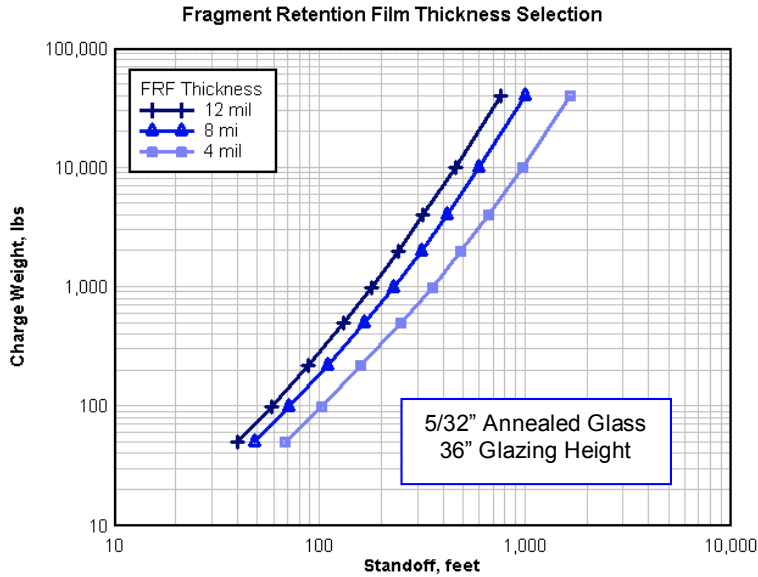

FOR OFFICIAL USE ONLY

Fragment Retention Film Thickness Selection

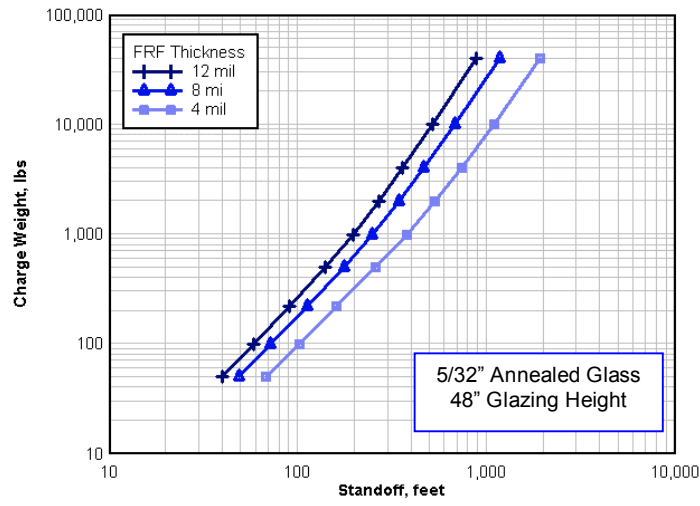

Fragment Retention Film Thickness Selection

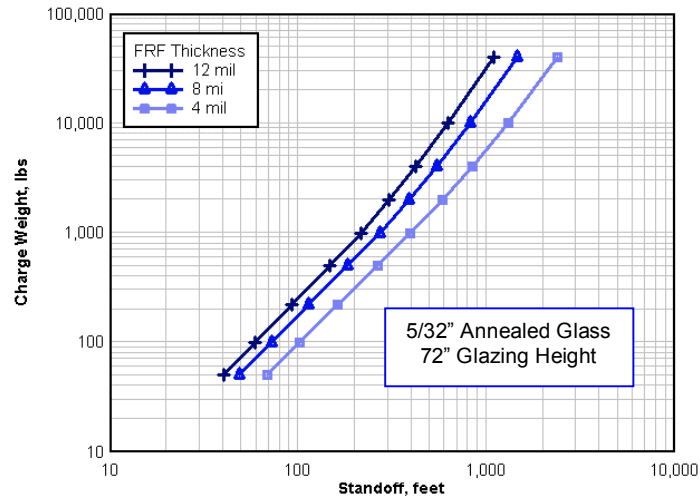

FOR OFFICIAL USE ONLY

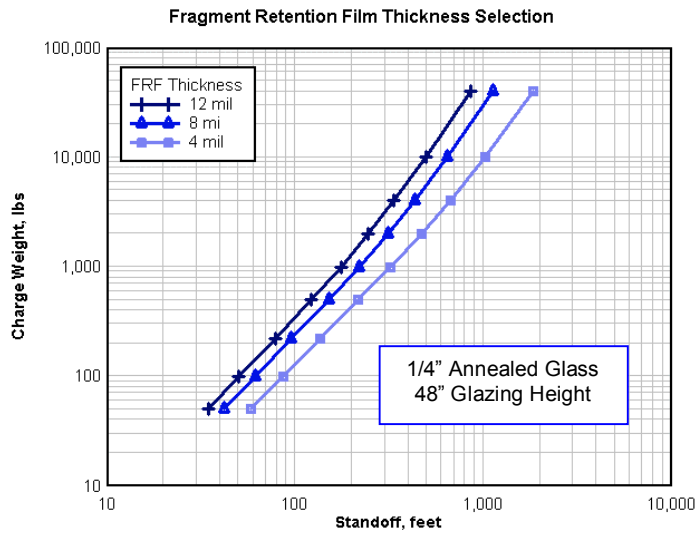
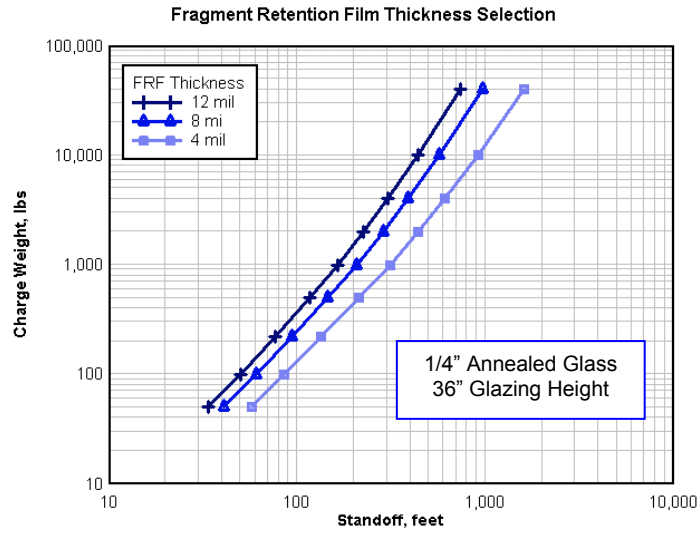

FOR OFFICIAL USE ONLY

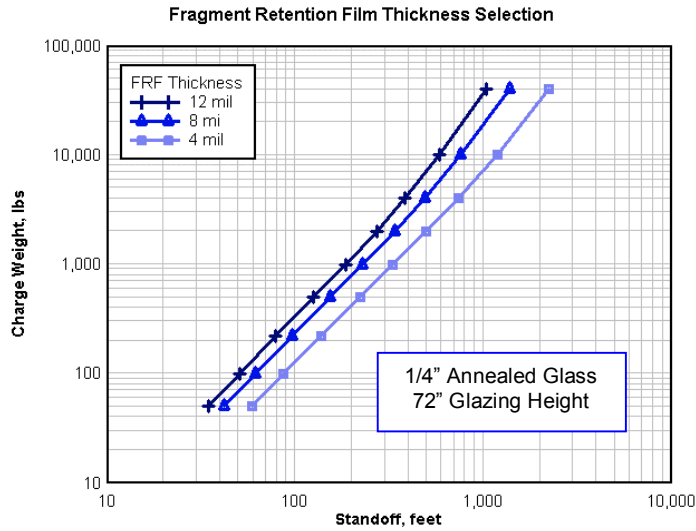

After the required film thickness has been established, the following catcher bar plot can be used to determine the required catcher bar diameter as a function of pipe type. The figure is based on the catcher bar being simply supported on each side of the window at a distance not more than 5” outside the edge of the glazing. If this type of support is not possible because of strength or space restrictions, resulting in the need for a longer bar span, the longer bar must be sized to give the same concentrated midspan load capacity as the shorter bar. Extrapolation beyond the maximum and minimum FRF thicknesses or glazing widths plotted in this figure is not recommended without experimental or analytical verification.

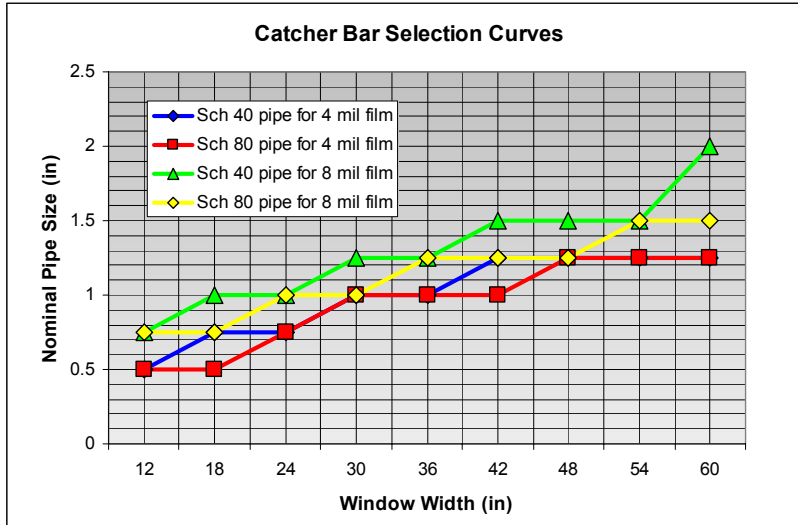

The catcher bar attachment brackets and anchorage shall be designed for the full yield strength of the catcher bar f_y S. The engineer is responsible to determine if the strength of the wall is sufficient to withstand the blast load and the loading of the catcher bar anchorage.

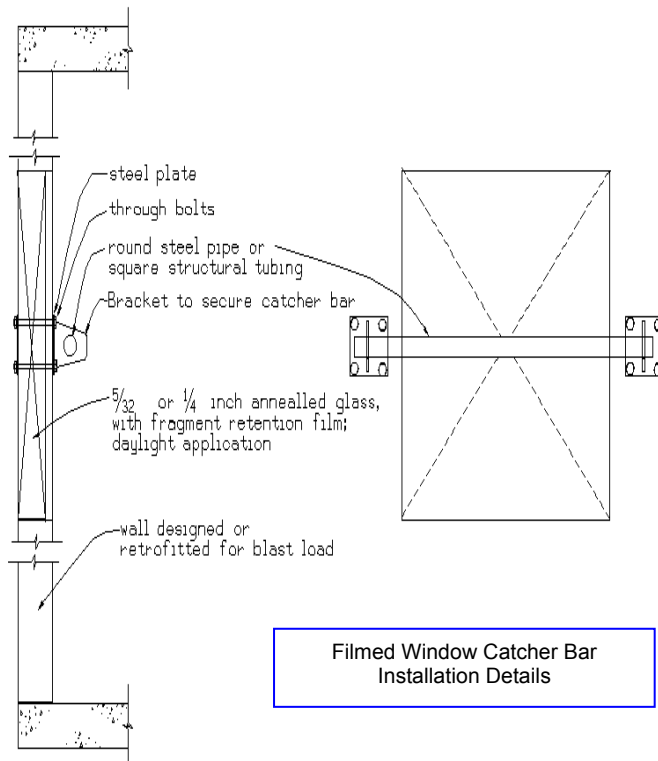

⁵ **Wall Retrofits:**

Wall retrofits using polymer coatings are described in Air Force ETL 02-xx, "Polymer Retrofit of Unrestricted Masonry Walls for Airblast," Draft, September 2002.

The retrofit methods described in COE Draft ETL, 13 October 1998 are directly applicable to buildings with concrete moment resisting frames and nonload bearing CMU infill walls. Other applications of these retrofits to nonload bearing unreinforced CMU walls must be evaluated on a case-by-case basis. Design

criteria were developed based on an 8-inch nominal CMU thickness and a wall height of 12 feet, and will be conservative for use with shorter walls and for walls with thicker CMU. Structural members that the CMU walls connect to at their top and bottom must allow for the attachment of the retrofit materials. This will require that the connecting members be either reinforced concrete slabs with a minimum thickness of 6 inches or beams that provide adequate edge distance for attachment anchors to develop the required shear capacity. Embedments necessary to develop the required anchor strength were determined based on a concrete compressive strength of 4,000 PSI and should be adjusted if the existing concrete strength is less.

Geotextile Fabric— A curtain of geotextile fabric is placed behind the CMU wall covering the entire inside face of the wall. In the event of an explosion the fabric serves to catch broken pieces of the wall, preventing them from flying into the protected space causing injury to the occupants. This retrofit method is effective, relatively inexpensive, uses lightweight materials and is easy to install. It is not applicable to walls with windows, as the fabric must span continuously from floor to ceiling without interruption, nor is it an aesthetically pleasing solution. A cross-section showing installation details is shown below.

FOR OFFICIAL USE ONLY

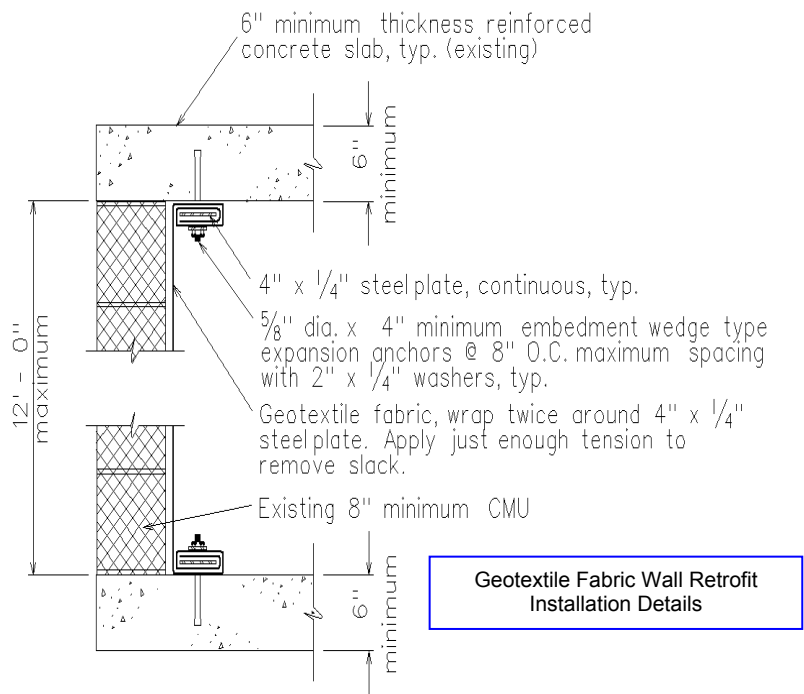

Geotextile fabric is a woven material with orthotropic strength properties. Fabric strength and stiffness is usually substantially greater in the primary or machine direction than in the orthogonal or cross direction. The strong direction of the fabric must be oriented vertically and the fabric securely anchored to a structural slab or beam at the top and bottom with just enough tension to remove slack.

The effectiveness of this type of retrofit depends on the load vs. strain behavior of the fabric as well as a secure attachment to an existing structure whose members have adequate strength. This document gives performance criteria for four different fabrics that

FOR OFFICIAL USE ONLY

may be used with this method. This is not a complete listing of fabrics that are suitable for this application; there are many others available. Information presented in this section will give an indication of the fabric property requirements. Load vs. strain data for each of the four fabrics is presented in the Table below. Data for three of the fabrics was taken from manufacturers data sheets and data for the fourth fabric was obtained from independent material tests. Comtrac R 500 is a product of Huesker Inc. of Germany, Mirafi HS 1715 and HS 800 are products of the Nicolon/Mirafi Group of the U.S., and UK Aramid is the W7660 fabric manufactured by Verseidag Indutex Limited of the U.K.

Fabric ID	Load at 5% Elongation (lb/in)	Load at 10% Elongation (lb/in)	Ultimate Load (lb/in)	Ultimate Elongation (%)
Comtrac R 500 (M)	1050	...	2800	12
Comtrac R 500 (C)	400	12
HS 1715 (M)	650	1350	1715	12**
HS 1715 (C)	275	600
HS 800 (M)	300	800	800**	10**
HS 800 (C)	220	550
UK Aramid (M)*	537	...	675	7.4
UK Aramid (C)*	480	...	602	7.1

(M) Indicates machine (strong) direction.

(C) Indicates cross machine (weak) direction.

* No manufacturers data available for this fabric, independent test results used.

** Assumed values used for analysis, not provided on manufacturers data sheets.

The anchorage system shown applies to all four fabrics. It was selected based on an assumed compressive strength for the existing concrete of $f'_c = 4,000$ PSI. The 4" embedment depth shown provides adequate capacity to develop the full strength of all fabrics, however deeper embedment, up to 8", should be used if the

FOR OFFICIAL USE ONLY

slab thickness allows. An 8" embedment length will assure ductile behavior of the anchors; shorter embedment lengths may result in brittle failures. Minimum embedment depth was set at 4" to accommodate a 6" minimum slab thickness, and thereby extend the usefulness of this system to as many structures as possible. If the anchors are to be embedded into a beam rather than a slab the edge distance from the center of the anchors to the inside face of the beam must be at least 6".

Blast load capacities for each of the geotextile fabric retrofits, presented in terms of charge weight vs. standoff distance, are shown in the following figure. Charge weight is the equivalent weight of TNT and the standoff distance is the distance from the center of the charge to the outside face of the wall. The data used to create the curves shown in the following figure was generated using analytical methods. All loads used in the analyses were normal reflected pressures. The method used was verified by comparison with experimental results to give conservative estimates of the retrofit wall response to blast loading. The 8" thick CMU wall was modeled as a one-way span of 12' between simple supports at its top and bottom. The fabric acts as a tension membrane spanning between the structural members at the top and bottom of the wall and was modeled as being installed in contact or nearly in contact with the inside face of the wall. The response limit used was a midspan deflection equal to 2/3 of the deflection at which the fabric reaches its ultimate strain.

FOR OFFICIAL USE ONLY

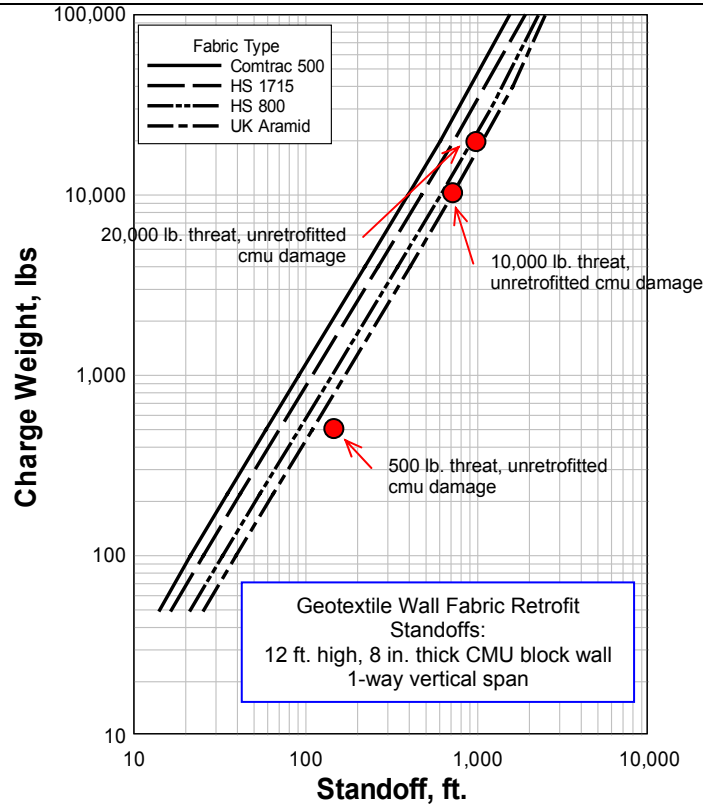

The following table gives approximate costs for materials and installation of geotextile fabric retrofits. Labor and equipment requirements are also listed below. Note that the material cost for the fabrics is a small part of the total retrofit cost, so that the total cost does not depend greatly on the type of fabric. Costs given in the table are average values for construction in the United States in 1998.

FOR OFFICIAL USE ONLY

Retrofit Fabric	Cost (per linear foot of wall) *			
	Material & Equipment	Labor	Overhead & Profit	Total
Huesker Comtrac R 500	\$32	\$34	\$18	\$84
Mirafi HS 1715	\$27	\$34	\$18	\$79
Mirafi HS 800	\$24	\$34	\$18	\$76
UK Aramid	\$40	\$34	\$18	\$92

* Cost estimates are based on a wall height of 12 feet.

Labor required:

- Carpenters.

Equipment required:

- Rotary hammer drill for drilling holes in concrete
- Miscellaneous hand and power tools

Reinforced Concrete Backing— A 4 or 6 inch thick reinforced concrete backing wall is placed against the inside face of the CMU wall. The backing wall is reinforced with a single layer of reinforcement midway through its thickness. Equal vertical and horizontal bars are used with the vertical bars placed toward the inside of the wall relative to the horizontal bars. Attachment at the top and bottom of the new wall is achieved by drilling into existing slabs or beams and placing anchors that lap with the vertical wall reinforcement. The anchors can be either through-bolts or reinforcing bars epoxy grouted into the existing structure. This retrofit method is very effective. It can also be used on walls that have windows. The concrete backing wall does add significant dead load to the structure and its effect on the conventional static and seismic design must be checked.

FOR OFFICIAL USE ONLY

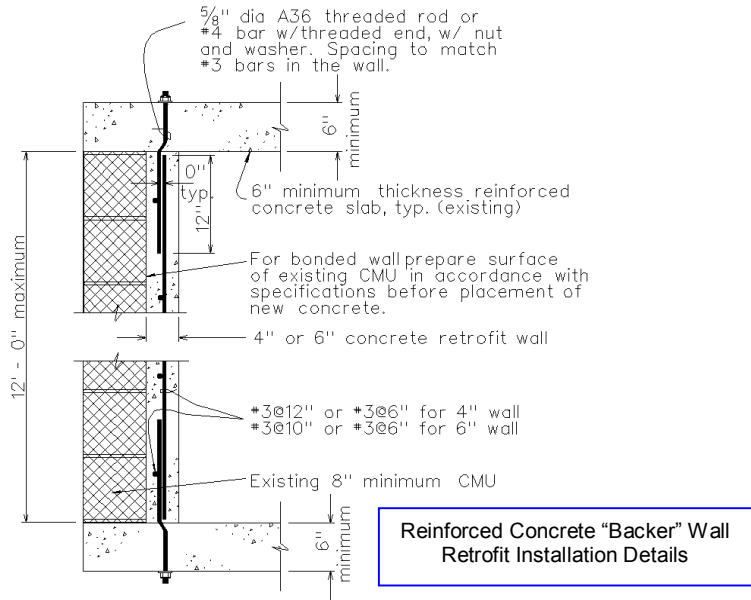

The reinforced concrete retrofit can be designed as bonded or unbonded. For the unbonded option no special preparation is done to the surface of the CMU wall before placing the backing wall. Without surface preparation the quality of the bond between the CMU and the concrete backing will not be reliable and the walls must be considered as acting separately, with the interface between them acting as a slip plane. The backing wall adds its strength to that of the CMU with no enhancement from composite action. If the surface of the CMU wall is properly prepared before placement of the concrete a strong reliable bond will develop at the interface and the two walls will act as a composite unit, giving a substantial strength increase over the unbonded wall. Surface preparation for the bonded wall should be done according to the guidance given in CWGS-03305 for preparation of concrete surfaces to which concrete is to be bonded.

Four combinations of backing wall thickness and reinforcing ratio are presented for both the bonded and the unbonded backing wall options. A backing wall thickness of 4" is used with reinforcement of either #3@12" or #3@6" and a backing wall thickness of 6" is used with reinforcement of either #3@10" or #3@6". Detailing options for the installation of the backing wall retrofits are presented in the figure shown above. The use of epoxy resin grouting for anchorage is an alternative that can be used when access for through bolting is difficult or impractical.

Material properties used in the development of these retrofits were a concrete compressive strength of $f'_c = 4,000$ PSI and reinforcing steel meeting ASTM A 615 grade 60. Epoxy-resin used for drilled and grouted reinforcing bar anchorage must meet ASTM C 881 type IV and be of the appropriate grade and class for installation conditions.

Blast load capacities for each of the reinforced concrete backing wall retrofits, presented in terms of charge weight vs. standoff distance, are given in the next figure. Charge weight is the equivalent weight of TNT and the standoff distance is the distance from the center of the charge to the outside face of the wall. The data used to create the curves shown in these figures was generated using analytical methods in accordance with TM 5-855-1. All analysis was done using normal reflected air blast. The method used was verified by comparison with experimental results to give conservative estimates of the retrofit wall response to blast loading.

FOR OFFICIAL USE ONLY

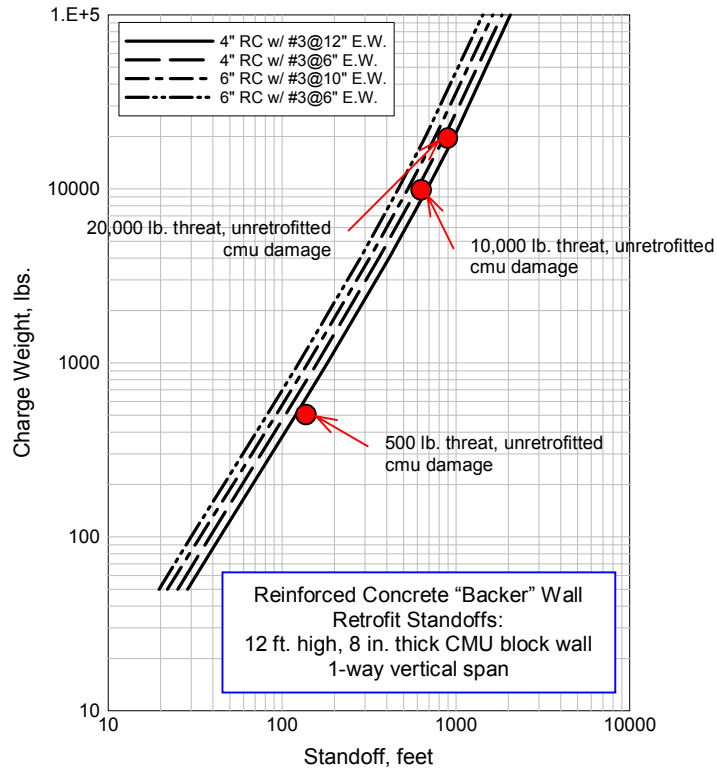

A reinforced concrete backing wall retrofit can be applied to walls with windows in many cases. The presence of a window opening weakens a wall and this weakening effect must be accounted for in the retrofit design. After selection of the retrofit backing wall design, the following additional requirements must be satisfied to allow the backing wall to compensate for the weakening effects of a window opening.

- (1) The width of the window opening must not exceed 80% of the vertical span of the retrofit wall.

- (2) The concrete backing wall must be placed behind any CMU wall above and below the window as well as on both sides.
- (3) Additional vertical reinforcing bars must be placed in the backing wall on each side of the opening. The amount of additional vertical reinforcing must equal or exceed the amount of vertical reinforcing interrupted by the opening, with half placed on each side. The additional bars should be distributed evenly in the backing wall close to the opening and over a wall width such that the reinforcing ratio in that width does not exceed 75% of the balanced strain-reinforcing ratio (per ACI 318). The additional bars must extend full height of the wall and be anchored into the existing structure in the same manner as the other bars.
- (4) If the width of wall between any two-window openings is insufficient for placement of the additional reinforcing required in (3), these two windows and the space between must be considered as a single opening width in (1).

For windows wider than specified in (1) above, use of this procedure is not recommended and more detailed considerations beyond the scope of this ETL are appropriate. Application of these retrofit measures to a wall with windows presupposes that the windows are also upgraded to a similar air blast protection level. One method for the retrofit of windows for air blast loading is described in ETL "Air Blast Mitigation of Glass Fragment Hazard Using Daylight Application of Fragment Retention Film with Catcher Bar."

The next table below gives approximate costs for materials and installation of the reinforced concrete backing wall retrofits. Labor and equipment requirements are also listed below. The difference in cost between epoxy grout anchored dowels and threaded rods with nuts and washers is negligible; thus, they are not given separate prices in the cost table. Costs given in the table are average values for construction in the United States in 1998.

FOR OFFICIAL USE ONLY

Retrofit Description	Cost (per linear foot of wall) *			
	Material & Equipment	Labor	Overhead & Profit	Total
Unbonded Reinforced Concrete Backing Wall				
4" backing wall w/ #3@12"	\$30	\$52	\$23	\$105
4" backing wall w/ #3@6"	\$37	\$71	\$31	\$139
6" backing wall w/ #3@10"	\$37	\$57	\$26	\$120
6" backing wall w/ #3@6"	\$42	\$73	\$32	\$147
Bonded Reinforced Concrete Backing Wall				
4" backing wall w/ #3@12"	\$38	\$64	\$29	\$131
4" backing wall w/ #3@6"	\$46	\$82	\$37	\$165
6" backing wall w/ #3@10"	\$46	\$69	\$33	\$148
6" backing wall w/ #3@6"	\$50	\$84	\$39	\$173

* Cost estimates are based on a wall height of 12 feet.

Labor required:

- Rodmen to place reinforcing steel
- Carpenters for formwork
- Cement finishers
- Skilled workers to drill holes in concrete and install dowels
- Equipment operators for concrete pump, boom truck, generator and air compressor with sand blasting attachments.

Equipment required:

- Concrete pump and 75' boom with truck
- Concrete vibrator
- Air compressor with attachments for sand blasting (needed for bonded backing walls only)
- Rotary hammer drill for drilling holes in concrete
- Miscellaneous hand and power tools

FOR OFFICIAL USE ONLY

⁶ ***BAIT / BASS / RODS Test Series:***

The Blast and Injury Tests (BAIT), Barrier Assessment for Safe Standoff (BASS)⁸ and Retrofits and Overpressure Design of Structures (RODS)¹⁰ were three coordinated initiatives that were conducted simultaneously by the United States Air Force (USAF) Force Protection Battlelab (FPB) during a series of 15 explosive tests. The series was conducted from July 12th, 2000 through September 30th, 2001 at the Energetic Materials Research and Testing Center (EMRTC) High Performance Magazine (HPM) test site in Socorro, New Mexico.

Execution of the test plan required the coordination of the efforts of numerous agencies and contractors, including: the USAF Force Protection Battlelab, Defense Threat Reduction Agency (DTRA), ARA-San Antonio, ARA-Denver, EMRTC, Scientific Applications International Corporation (SAIC), AFCESA at Tyndall AFB, United States Army Corps of Engineers (USACE) Protective Design center (PDC), Air Force Combat Support Systems (AFCSS) at Eglin AFB, the 49th Material Maintenance Squadron at Holloman AFB, the 62nd Engineers at Ft. Hood, the United States Army's Institute for Surgical Research, and the University of Virginia's Automobile Safety Laboratory.

BAIT Tests

Historically, the focus of the blast community has been on understanding air blast phenomena and the response of structures to blast effects. In the context of terrorist attacks, however, the primary cost of an explosion is measured primarily in injuries to personnel, and only subsequently in terms of damage to structures. Thus, when the United States Air Force (USAF) Force Protection Battlelab (FPB) was tasked to develop the Vehicle Bomb Mitigation Guide (VMBG), the paucity of information on personnel vulnerability became immediately apparent. Based on the minimal data that was

FOR OFFICIAL USE ONLY

available, the primary risk to personnel at expeditionary sites is inside structures such as tents, trailers, huts and other improvised habitations. Thus, the objective of the BAIT initiative was to gather sufficient data to quantify injuries to personnel inside blast-impacted expeditionary and temporary structures.

Improved assessment methods for personnel vulnerability and casualty predictions were developed with test data from all fifteen tests, which were conducted with charge sizes of approximately 250, 600, 2,450, and 12,200 pounds Ammonium Nitrate/Fuel Oil (ANFO) at varying standoff distances. Biofidelic specimens and modified Hybrid III anthropomorphic test dummies (ATDs) were placed in expeditionary and temporary structures in six tests, positioned at varying distances from 2,450 pounds ANFO, such that they were subjected to a range of overpressure and impulse conditions sufficient to ensure varying injury results.

Amid shelter debris impact and shelter collapse, overall body motion and overpressure measurements of human body response were made by applying accelerometers and pressure gages to the torsos and heads of cadavers and dummies. Necropsies of the post-test cadavers were performed to quantify the level of injury and the probability of fatality. The environment within the expeditionary structure was characterized with pressure gages and high-speed cameras to record physical insults to the biofidelic specimens and to observe overall body motion. In addition, selected expeditionary structures were instrumented to measure the reflected pressures at the structure, the acceleration of the tent canvas and frame, and the frame deflection. Post-test structural response observations and measurements were also made. Data collected for these structures were used to correlate the observed injuries with the structural debris environment experienced by the biofidelic specimens.

In the event of a structural failure of a TEMPER, there is a risk of blunt trauma to the head, face, neck and thorax. At a

FOR OFFICIAL USE ONLY

threshold of structural damage typically referred to as “failure” by structural engineers, where at least one major supporting component of the structure has completely failed, the risk of severe injury appears to be greater in a TEMPER tent than a Southeast Asia (SEA) Hut. This is primarily due to the more hazardous nature of the TEMPER frame debris, which may be easily mitigated through the use of frame padding. In SEA Huts, blunt trauma injuries also occurred to the face, neck and chest. It is only at higher levels of structural damage for the SEA Hut, where complete collapse of the SEA Hut roof occurs, that similar levels of injury are seen.

The cadaver necropsies and anthropomorphic data analyses demonstrated that structure damage and injury correlations work well for the TEMPER structures. Slight to severe structural damage correlates to a chance of injury, but a low probability of fatality, while severe damage to failure correlates to a high probability of injury and a moderate probability of fatality. For SEA Huts, on the other hand, structural damage and injuries do not correlate as well. Specifically, failure of structural components does *not* correspond to a high likelihood of severe injury or fatality. Instead, severe injuries and potential fatalities were only observed when structural collapse occurred.

It should be noted, however, that the probability of being hit with structural members in the TEMPER is considerably lower than that in the SEA Hut. Thus, while not specifically addressed in this test series as a test variable, personnel location and structure population will determine the probability of injury in each structure. Injuries created by the blast debris inside the TEMPER tents and SEA Huts would require, at a minimum, substantial medical resources for treatment, with a high probability of permanent disability if not mortality.

FOR OFFICIAL USE ONLY



Pre-test Anthropomorph and Cadaver Setup Inside a SEA Hut



Post-test Anthropomorph and Cadaver Setup Inside a SEA Hut

FOR OFFICIAL USE ONLY

⁷ *Primary Debris Calculations:*

Only DiPole Might tests 2, 15 and 22 (for 500, 5,000, and 20,000 lbs, respectively) were evaluated to determine safe standoffs based on vehicle debris. In total, 40 DiPole Might tests were conducted, and numerous complete vehicles were recovered. While larger quantities of vehicles and fragments were not recovered in tests 2, 15 and 22, numerous complete vehicles were recovered in other tests. Technical reports for those tests include collected debris data consisting of debris location, some descriptions and some weights. For DM 2 (500 lbs in a sedan) no debris weights were measured and a total of 1,272 vehicle pieces were collected. The DM 15 data (5,000 lbs) consisted of 914 pieces for a total of 4,128 lbs of debris collected. DM 22 data (20,000 lbs) consisted of 1,030 pieces for a total of 1,560 lbs. A tare weight for the Ford F700 series truck, used in DM 15 and 20, was not reported, but is estimated to be approximately 12,000 lbs. Thus, the reported total collected weights for the DM 15 and 22 tests were approximately 33% and 12% of the total vehicle weight respectively.

The following plots present probability of hit by any debris for the three DM tests. Because of the uncertainty associated with collected debris weight (versus total vehicle weight) very low probabilities of hit are assumed to be appropriate for safe standoff determination. Thus, a 0.1% probability has been assumed a safe standoff threshold (1200 ft) for the 20,000 LVB scenario, since only 12% of that vehicles weight was reported discovered. Likewise, standoffs between 0.2% and 0.5% were assumed appropriate for safe standoff determination (1200 ft) for the 5000 lb case as only 33% of the vehicle was discovered post-test.

FOR OFFICIAL USE ONLY

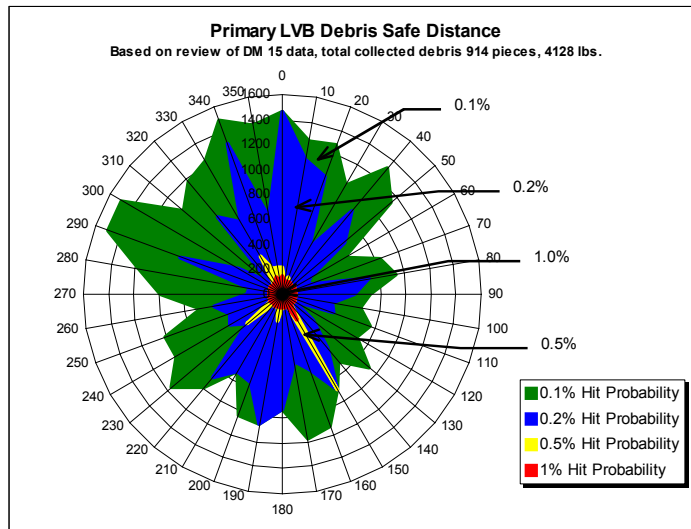
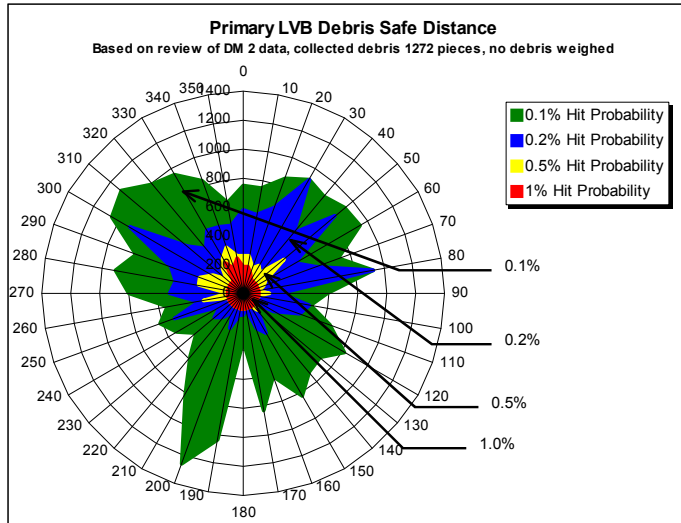

FOR OFFICIAL USE ONLY

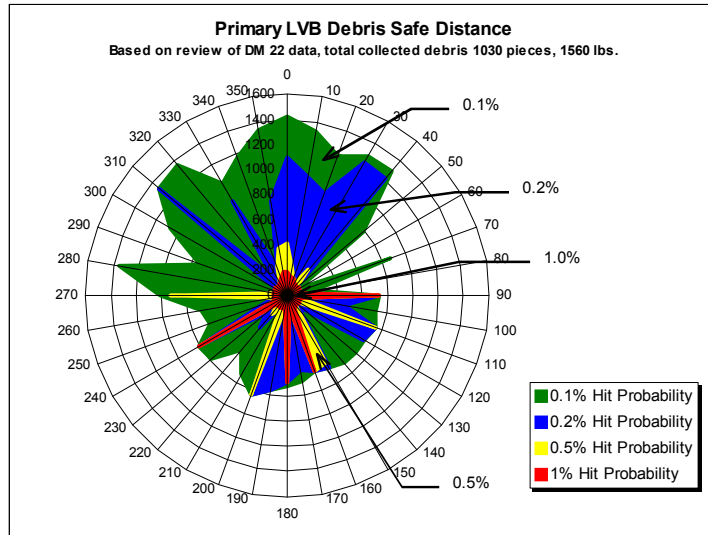

⁸ **Secondary Debris Calculations:**

In the last several decades, vehicle bombs have been a favorite tactic used by terrorists to try to achieve their objectives. United States (US) Government installations, determined to prevent vehicle bombs from reaching the desired location, conduct various search activities on all vehicles entering a base or facility. One common method of accomplishing a search is to install Entry Control Points using a variety of vehicle barrier configurations to force entering vehicles to stop at a designated location and be searched.

While an ECP may be effective in preventing entry of a suspected vehicle bomb into an installation, it does not necessarily prevent detonation of the bomb at the ECP. Typical barriers used to create the ECP are designed for vehicle impact loads, not blast loads. When a vehicle bomb detonates at an ECP, the barriers can fragment

and throw debris great distances, depending on the explosive quantity in the bomb. This debris, which can be as large as a whole barrier section, presents a significant hazard to personnel, and possibly structures, in the vicinity of the detonation. A method of predicting this debris hazard will aid in the safe placement of ECPs, the protection of surrounding assets, and in the design of less hazardous barriers.

BASS Tests

BASS experiments were conducted in twelve of the fifteen tests in the series, each using full-scale, bare-explosive tests on Entry Control Point (ECP) vehicle barriers in various barrier, charge weight, and standoff configurations. Ten different barrier types were tested, with two barrier types used per test. The barriers tested included:

- Jersey
- Jersey with soil backing
- Bitburg
- Bitburg with soil backing
- Jersey with polymer liner applied
- Cellular Jersey with polymer liner applied
- Jersey with rock/gravel fill backing
- Back-to-back Bitburgs
- Texas
- Plastic, sand-filled barrier

Three charge weights (600, 2,450, and 12,200 pounds of Ammonium Nitrate/Fuel Oil [ANFO]) and two charge standoffs (10 and 35 feet) were tested. Data collection included documentation of the barrier response to the blast load, barrier debris pickup in designated areas behind each barrier, high-speed video of debris to aid in measuring debris velocities, and free-field pressure measurements at specific locations in the debris fields.

FOR OFFICIAL USE ONLY

Specific conclusions from the BASS test series are that vehicle barriers currently in use can be modified or relocated to decrease the secondary debris safe distance for a facility and that some new barrier concepts were also effective in reducing the safe distance. Concrete barriers currently in use at ECPs (Jerseys and Bitburgs) should be soil-backed to decrease debris hazards. Enforcement of a 35 foot vehicle-to-barrier standoff will also reduce debris hazards and is highly recommended. Of the other concept barriers tested in BASS, the cellular Jersey and sand-filled plastic barriers exhibited substantial reduction in debris distance as well. These concept barriers still needed to be tested for counter-mobility performance to make sure the site perimeter is still protected. Of all the barrier types tested, the back-to-back Bitburgs were the most effective at the 10-foot standoff (resulted in no debris being thrown).

During post-test investigations sponsored by the Force Protection Battlelab, the standard Jersey barriers (no soil, 3 cables through barrier lifting hooks), the cellular or lightweight Jersey barriers (no soil and also cabled) and a larger version of the sand-filled barriers were subjected to a 30 mph crash test with a 15,000 lb truck (DoS standard K4 and L2 test specifications; no more than 20 ft penetration, 30 mph, 15,000 lb truck.) The standard Jersey and cellular barriers performed within the specifications. The sand filled barrier did not meet the performance specifications, and should not be considered for use as a counter-mobility barrier.

“Before Test” and “After Test” photos of barriers follow.

FOR OFFICIAL USE ONLY



Standard Jersey Barriers



Light-weight Jersey Barriers



Sand-filled Plastic Barriers

Secondary debris characteristics (velocity, mass and trajectory) for concrete barriers (Jersey, Bitburg, and Texas type) are based on a modified DISPRED approach (Debris Dispersion Prediction model developed for DOE and DDESB). The modifications are the result of comparisons of DISPRED predictions with barrier debris dispersion data collected during the Barrier Assessment for Safe Standoff (BASS) tests.

Three charge weights (600 lbs, 2,450 lbs, and 12,200 lbs of ANFO) were tested at two charge-to-barrier standoffs (10' and 35'). Jersey, Bitburg, and Texas barriers were tested with and without soil

FOR OFFICIAL USE ONLY

backing. After each test, concrete barrier debris was collected in 10' by 10' "bins" across a 120' width in front of the original barrier location. A portable grid was used to mark the bins in 10' intervals, moving out from the detonation site to the maximum trajectory distance. Debris were collected, counted, and weighed in each bin to obtain an average weight and debris density per bin. A debris density plot, such as the example below (test of a Bitburg barrier with a 35' standoff from a 12,200 lb ANFO charge), shows the overall dispersion of debris. Debris stopping distance in feet is plotted as a function of distance along the barrier in feet. The color-coding in the plot legend indicates debris densities. Densities of 60, 30, and 6 per 600 ft², corresponding to 10%, 5%, and 1% hit probabilities, are indicated.

FOR OFFICIAL USE ONLY

East Debris Field Test #6
Bitburg 5 Section
12200lb @ 35ft

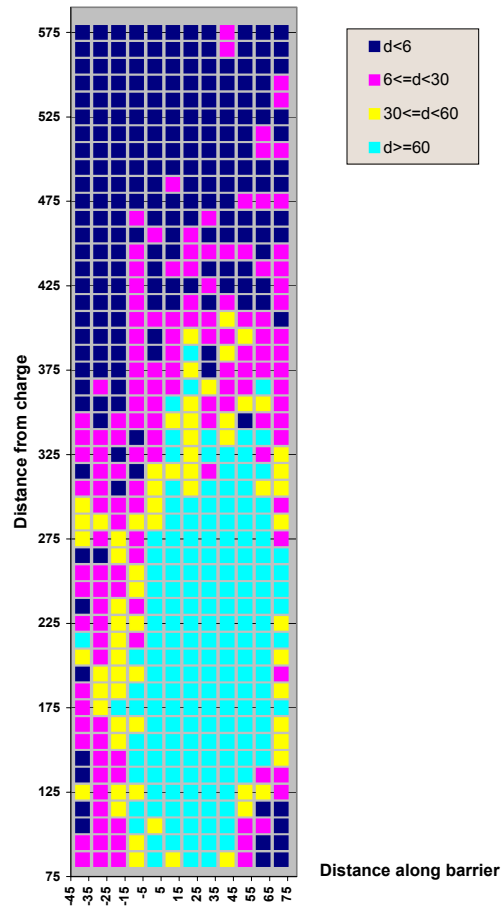

FOR OFFICIAL USE ONLY

Debris trajectory and distance calculations were made with the MUDEMIMP code, part of the DISPRE model. Roll after impact was included in the debris distance calculations because significant roll was observed in videos and high-speed films of the BASS tests. Certain aspects of DISPRE were modified to account for the differences between rectangular structure walls and the ECP stand-alone barrier walls. Load reductions normally taken in DISPRE do not apply to the barriers. Also, the areas used in MUDEMIMP to calculate debris density were modified to exclude the 5-degree spread of debris out from the corners of the barrier. The use of this spread angle is based on the dispersion of debris observed in tests of walls of rectangular concrete and masonry structures. The ECP barriers are generally shorter and longer than those tested to generate the original DISPRE data. Using only the rectangular area bordered by the normal to each barrier end proved to be a better match to the BASS data. Finally, the use of soil backing does reduce debris velocity and resultant debris throw distance, but not as significantly as if the entire mass of the soil backing were added to the mass of the barrier to decrease the velocity. All modifications to the DISPRE approach were made after careful investigation of the BASS test data and the unique features of the ECP barriers.

The maximum distances for debris densities corresponding to 1%, 5%, and 10% hit probabilities along the barrier width were then plotted. Safe distances predicted using the modified DISPRE approach could thus be compared directly to the BASS test data. Typical comparison plots generated for barriers with and without soil backing are presented here. Values from this type of plot have been used to create the standoff values for the charts in the guide.

FOR OFFICIAL USE ONLY

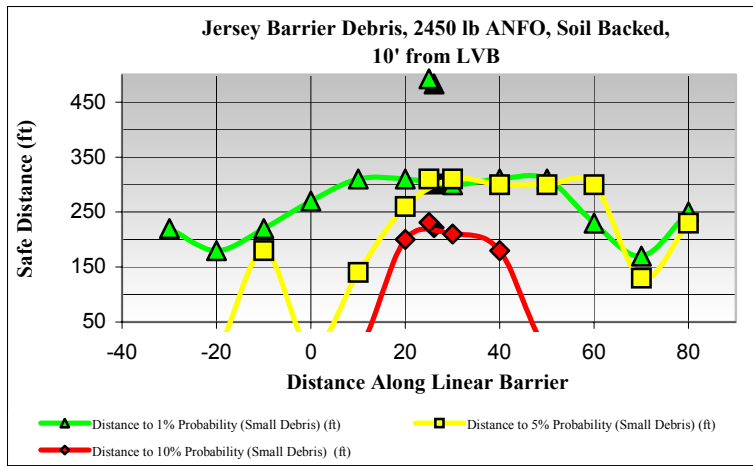
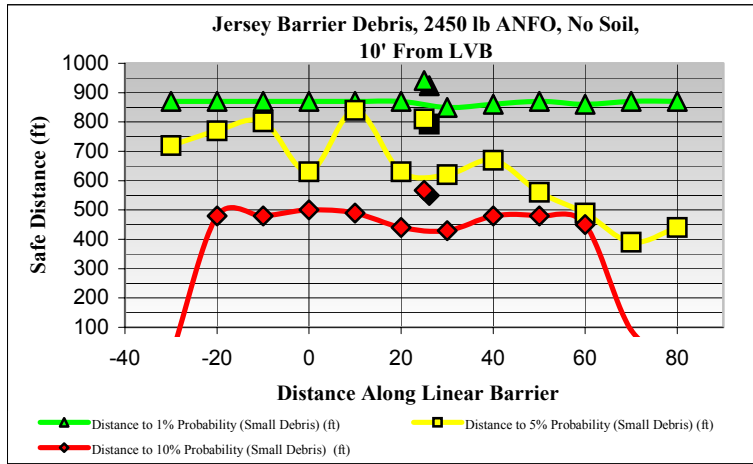

FOR OFFICIAL USE ONLY

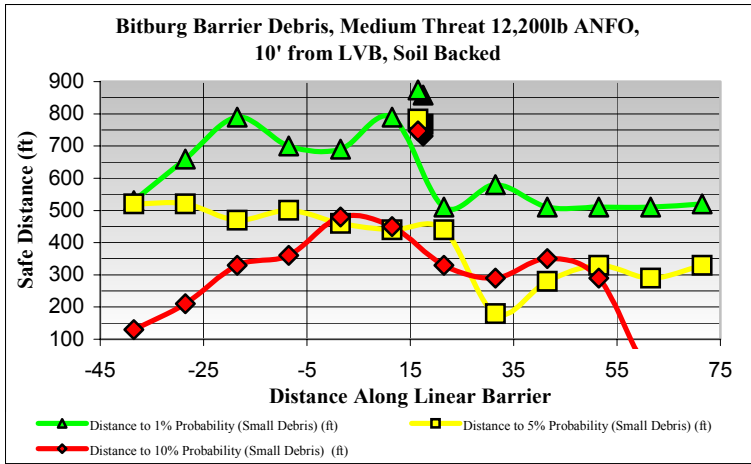
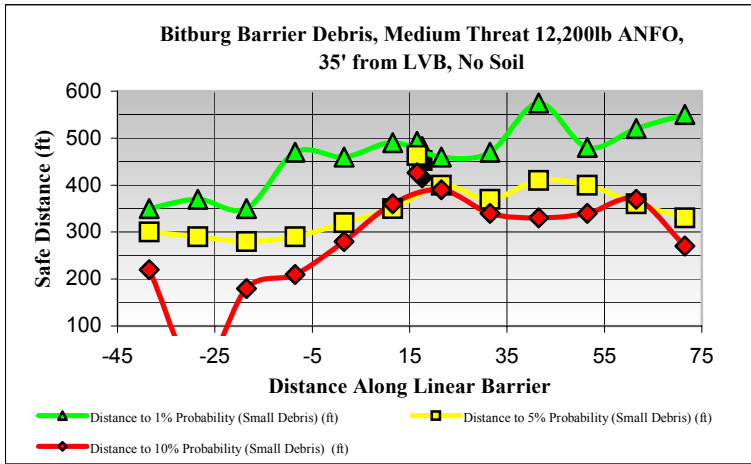

FOR OFFICIAL USE ONLY

⁹ ***Blast Barrier and Blast Wall Attenuation Calculations:***

Blast barrier attenuation effectiveness and the resulting distances were calculated using Waterways Experimental Station (WES)/TM 5-853 charts, compared with data from the Eskan wall calculations (for the 20K shot) and preliminary data from the WES PingPong tests, provided by WES.

As stated in the guide, blast barriers (walls erected near the LVB designed to reduce pressures and impulses) will do little to reduce standoffs for standard commercial construction, as reduced pressures and impulses behind the barrier are generally still too large to allow these structures to survive in those regions. The plots below show pressure and impulse attenuation factors (a multiplier applied to the actual reflected pressure and impulse) based on the Eskan data and the TM 5-853 approach.

FOR OFFICIAL USE ONLY

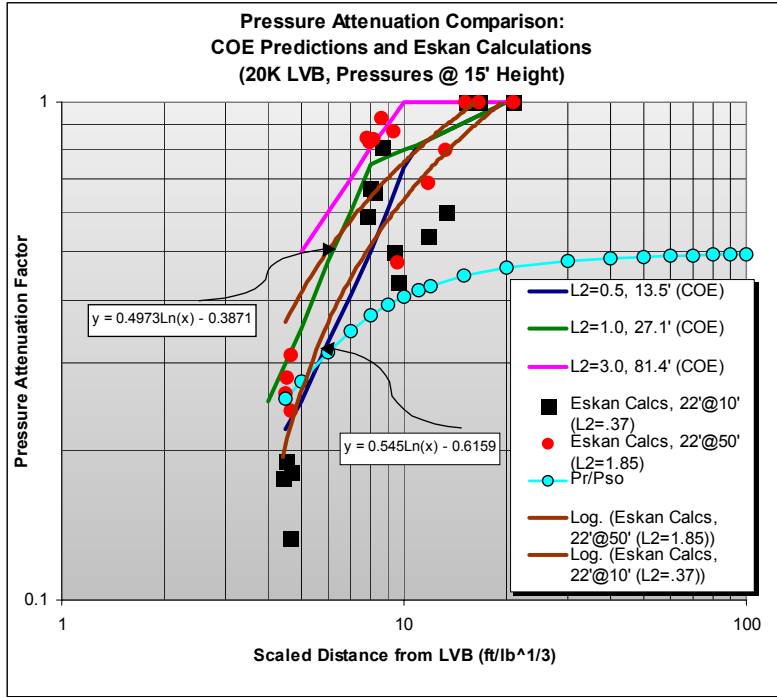

FOR OFFICIAL USE ONLY

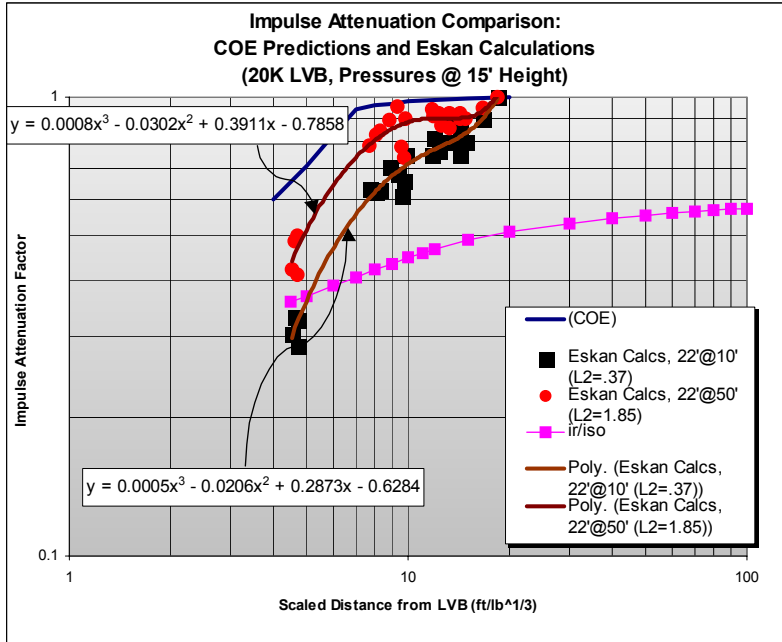

Comparisons are shown for similar scaled wall heights (wall height divided by the cube root of the charge weight). The value of L2 noted for the data is the scaled distance from the charge to the barrier, i.e., the distance from the barrier to the charge (ft.) divided by the cube root of the LVB weight in lbs. Also included on the plots are fits to the Eskan data for the two L2's considered, and a plot of the ratio of incident pressure to reflected pressure.

The plots show that the Eskan data matches the COE predictions reasonably well for pressure, but overpredicts impulse reduction as compared with the COE data. It should be noted that the impulse reduction (attenuation factor) from TM 5-853 is independent of L2.

These data and calculations were later compared with the 50th scale data provided by WES from selected tests in the PingPong series. The PingPong data used were from tests B122-30-3, (L2=0.23, SWH (scaled wall height)=0.93), B122-90-2, (L2=0.55, SWH=0.93), and FF-72-3, (0 Barrier Wall Height, 90mm Standoff, 72 gram Charge). Values of measured incident pressure and impulse were converted to reflected values using equations derived from the BRL equations for incident and reflected pressure for TNT.

The plots below show the comparison of ESKAN, COE and PingPong data. The first plot compares the ESKAN calculations and the PingPong data for attenuated pressure.

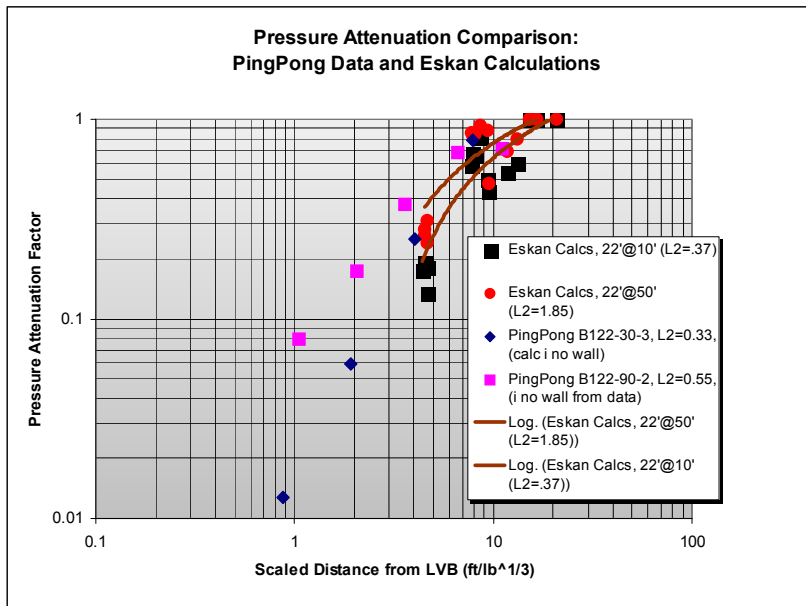

Like the plots comparing Eskan data to the COE approach, the PingPong data compares favorably to both of those data sets, and, hence, to the fit generated based on that data.

The next plot compares COE, Eskan and PingPong data for impulse. The comparison here is again not favorable for the Eskan data. It appears that the PingPong data better matches the COE data for similar L2 and SWH. Appropriate values of attenuation for impulse probably lie somewhere in between, as the original PingPong data is based on incident measurements (that shown on the plots is analytically adjusted to reflected), and the Eskan calculations are calculated reflected values. Thus, for the plots of pressure and impulse shown in the remaining plots the upper (more conservative) fit was used to generate that data. The fits finally used then are:

$y = 0.4973\text{Ln}(x) - 0.3871$ for pressure attenuation factor, and
 $y = 0.0008x^3 - 0.0302x^2 + 0.3911x - 0.7858$ for impulse attenuation factor, where y is the attenuation factor and x is the scaled standoff in $\text{ft/lb}^{1/3}$.

FOR OFFICIAL USE ONLY

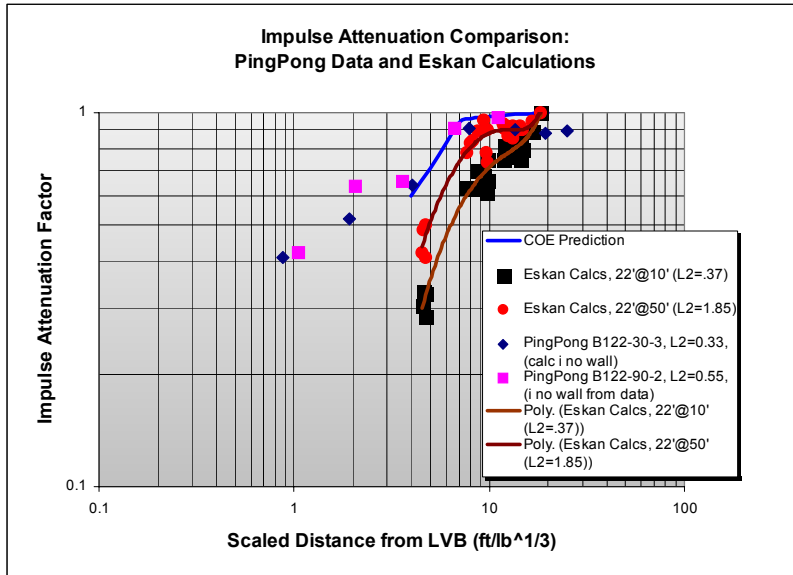

The remaining plots present calculated values of pressure and impulse using the equations derived from fits to the data described above.

Data on each plot shows unattenuated pressure (or impulse)—without barrier, attenuated pressure (or impulse)—with barrier, and attenuated pressure (or impulse)—with blast wall in place. The blast wall is assumed to be placed directly in front of the protected asset and assumed to completely reduce the applied pressure or impulse to the incident value.

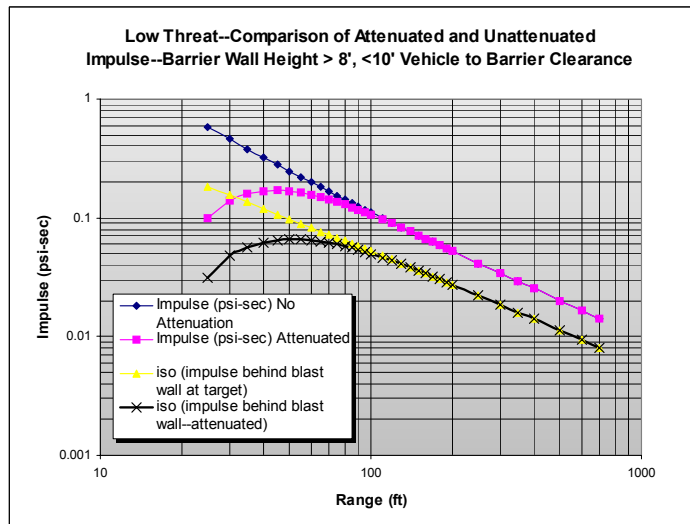
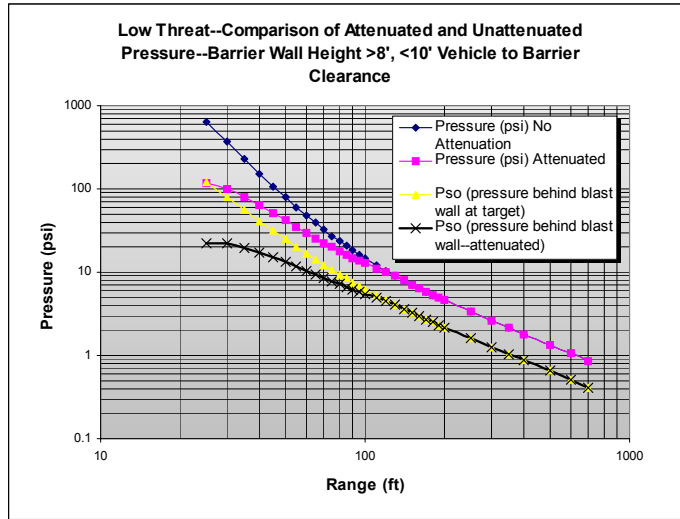

FOR OFFICIAL USE ONLY

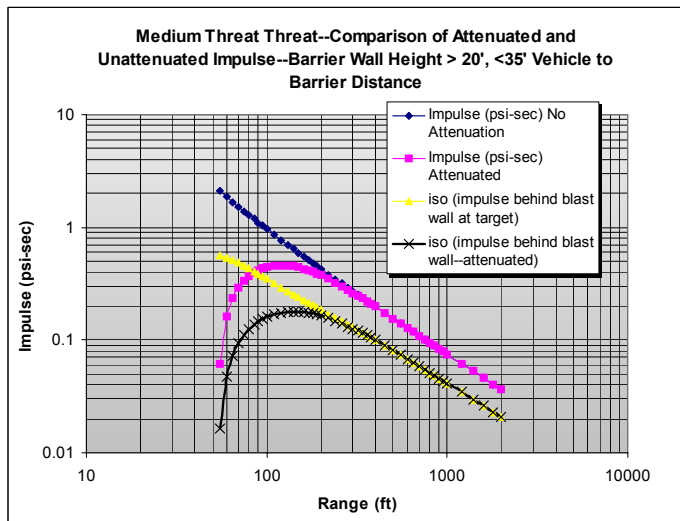
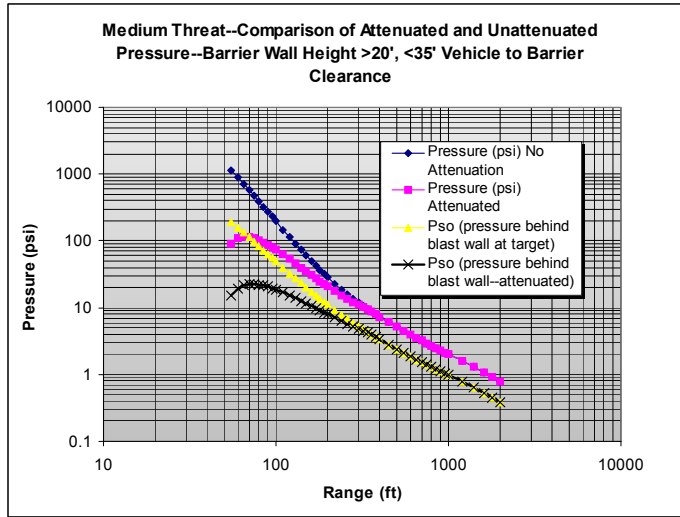

FOR OFFICIAL USE ONLY

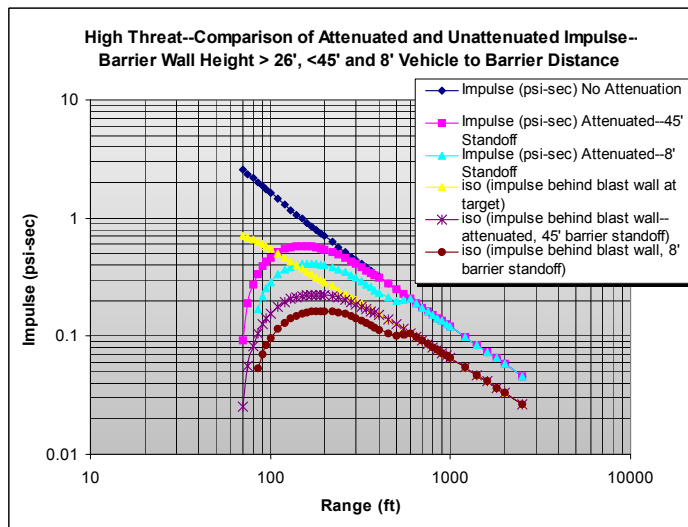
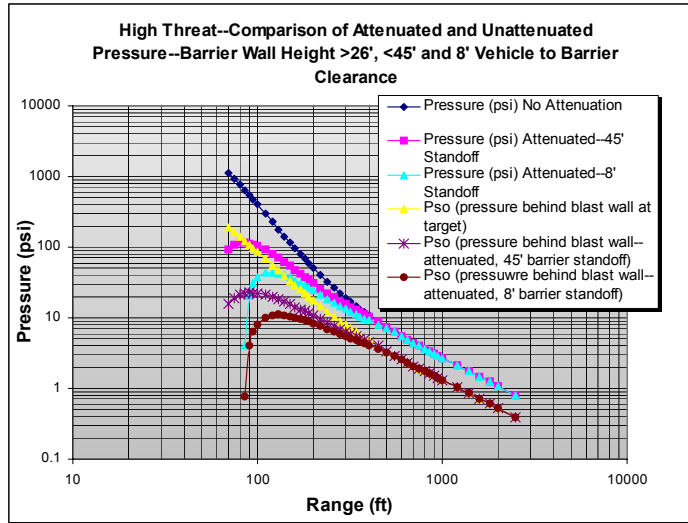

FOR OFFICIAL USE ONLY

¹⁰ ***Structural Response Calculations:***

Simplified structural response techniques were used to define pressure-impulse spaces for each of four components considered in the guide development: (1) commercial construction (8 in. concrete masonry unit (CMU) infill walls, two types of expeditionary structures including (2) TEMPER tents, (3) Southwest Asia (SWA) style trailers, and (4) standard annealed window glass. Specific P-I diagrams were developed for 1-3 above, while data provided in the UK Glazing Hazard Guide was used to define the response of annealed and filmed annealed glass.

RODS Tests

When deployed overseas, significant numbers of United States Air Force (USAF) personnel are often housed in expeditionary and temporary shelters that are adjacent to parking lots, entry control points (ECPs), or active roadways. Should a LVB detonation occur, the potential for significant casualties is large, with the extent of the casualties being strongly dependent on the response of the temporary and expeditionary shelters.

In creating the VBMG, it became obvious that the available test data and corresponding engineering models for temporary and expeditionary shelters were limited or non-existent. This deficiency was the motivation for the RODS initiative: to develop the data and models needed to provide sound guidance to the installation commander on the placement, orientation, usage, and retrofit of these structures.

To accomplish these objectives, explosive tests of currently deployed structures were performed; retrofit concepts were devised and implemented; and the retrofitted shelters were explosively tested using the same explosive weights and standoffs. These experiments were conducted in fourteen of the fifteen tests in the series, each

FOR OFFICIAL USE ONLY

using various structure, charge weight, and standoff configurations. The structure types included:

- Tent, Extendable, Modular PERsonnel (TEMPER), which is an aluminum frame structure covered by canvas or nylon material
- Southeast Asia Hut (SEA Hut), an elevated, wood-framed, barracks structure fabricated with dimensional lumber and plywood;
- Small Shelter System (SSS), a recently developed, fabric-covered, aluminum frame structure
- Various retrofit concepts for the TEMPER and SEA Hut.

Four charge weights (250, 600, 2,450, and 12,200 pounds of Ammonium Nitrate/Fuel Oil [ANFO]) were tested. The experimental data were used to develop, verify, and modify engineering models for expeditionary and temporary shelters and to assess the performance of retrofitted shelters subjected to LVB overpressures.

The data from the explosive tests of expeditionary and temporary structures showed that the existing SEA Hut design is not very robust in terms of blast resistance, and large debris with significant velocities were generated when a SEA Hut failed. This debris obviously poses a significant hazard to personnel. Human injury vulnerability can be significantly reduced by applying simple structural retrofits with standard construction materials such as applying interior plywood, bracing, and reversing the door swing. Novel processes, such as polymer coating, can also provide increased protection.

FOR OFFICIAL USE ONLY



Pre and Post Test SEA Hut

The TEMPER is an effective and efficient structure for resisting/surviving overpressures at fairly close standoffs. Its design appears to be fairly well optimized relative to blast resistance, as there is no easily identified “weak link” that can be strengthened without significant modifications to the entire structure. As with the SEA Hut, failure of the TEMPER resulted in significant debris, in this case, fractured aluminum frame members.



Pre and Post Test TEMPER

The test results show that with an end-on orientation of the TEMPER, the damage can be significantly decreased; however, for the SEA Hut, little difference was observed. The improved response for the TEMPER suggests that it may be wise to deploy them such that the end faces towards the most likely source of an LVB detonation (parking lot, ECP, roadway perimeter, etc).

FOR OFFICIAL USE ONLY

Finally, the test results for the SSS are not as clear as for the SEA Hut and TEMPER, due to the limited number of specimens and the weakness of the fabric that was supplied with the SSS test specimens.



Pre and Post Test Figures of the SSS

Structure P-i Plots

The responses of the SEA Hut, Retrofitted SEA Hut, TEMPER, and SSS are depicted in the next several plots. Each of the structures tested during the RODS series is shown on these plots, and is colored in accordance with the level of damage that it sustained during testing.

It should be noted that the response plot for the SSS is based on relatively few data points when compared to the SEA Hut and TEMPER. This is due to the relatively small number of SSS specimens tested during the series. As such, the plot for the SSS is the least refined of the three.

The green, yellow, and red lines depict the pressure and impulse conditions that yield slight damage, severe damage, and failure, respectively. An exception to this is the Retrofitted SEA Hut, which is plotted side-by-side with the normal SEA Hut, and is depicted utilizing blue, brown, and purple respectively.

As may be readily observed, the damage to each structure type increases with increasing pressure and impulse values. These plots may be utilized to gauge the structural response to a given

FOR OFFICIAL USE ONLY

threat, once the threat and standoff have been translated into an effective pressure and impulse value.

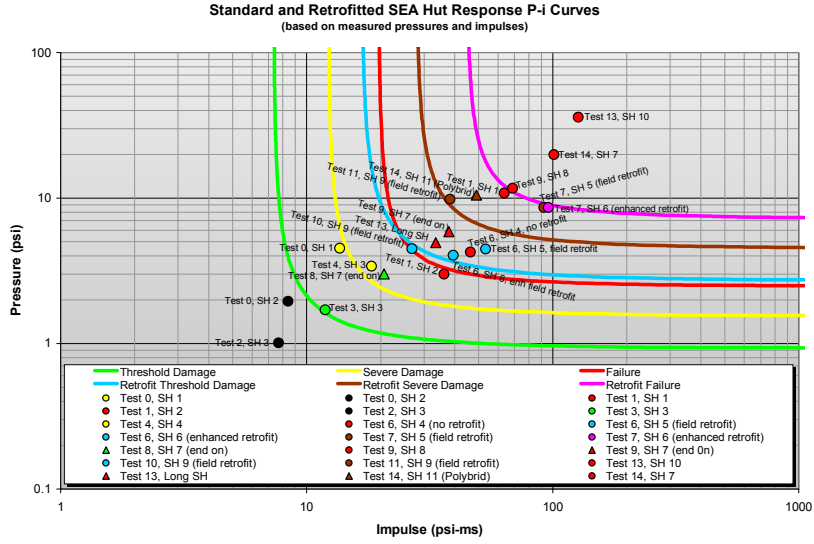

FOR OFFICIAL USE ONLY

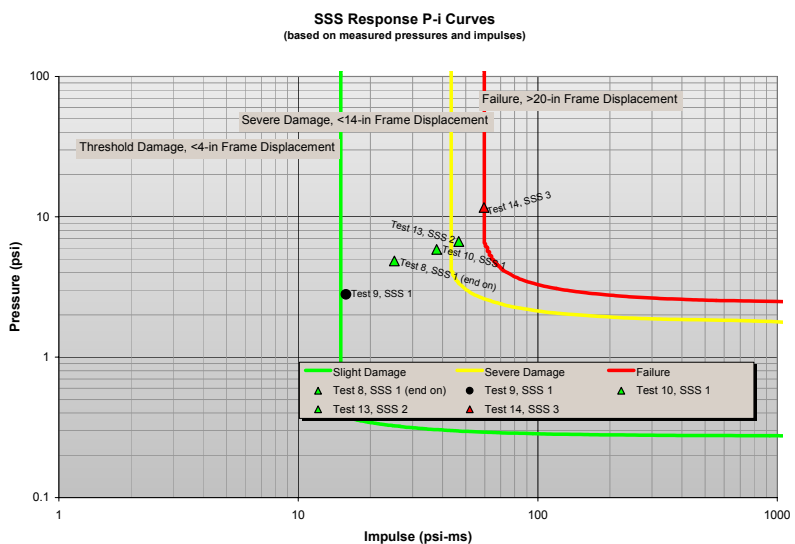
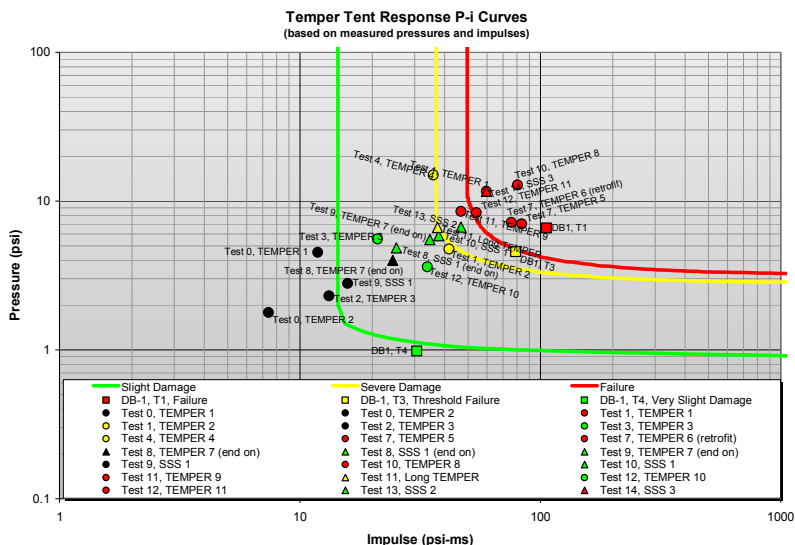

FOR OFFICIAL USE ONLY

SEA Hut Retrofit

The recommended retrofit for the SEA Hut was chosen from several different retrofit concepts that were tested in the RODS series. This retrofit uses components and fasteners already employed in SEA Hut construction, making adaptation of existing SEA Huts straightforward. The retrofit design hardens the structure to blast, giving it a better response and helping prevent the intrusion of wall studs.

There are no windows in the retrofitted SEA Hut design, and plywood is used to cover the interior and exterior of the walls. The doors of the SEA Hut are reversed, such that they open toward the outside. A second layer of plywood is added to the existing floor. Dimensional lumber is used to reinforce the upper portion of the interior paneled walls and the floor immediately adjacent to the walls, running the full periphery of the SEA Hut. Finally, the lower truss members are reinforced with dimensional lumber, which is attached to the existing joists. An overall view of the interior of the retrofitted SEA Hut is shown below.



Overall View of Retrofitted SEA Hut

FOR OFFICIAL USE ONLY

To retrofit an existing SEA Hut, the following steps should be undertaken:

1. Cover windows with $\frac{3}{4}$ " plywood.
2. Reverse the doors so that they open to the outside.
3. Add a second layer of $\frac{3}{4}$ " plywood flooring to the existing floor. Attach this layer utilizing nails of sufficient length at 6" on center, and stagger the new layer of flooring panels opposite to that of the existing floor so that no seams in the two layers of flooring overlap.
4. Add $\frac{3}{4}$ " plywood to the interior walls. Nail the sheets at 6" on center.
5. Attach a 2" x 6" floor plate around the periphery of interior (Figure A). Ensure that the narrow edge of the plate is butted firmly against the lower edge of the wall paneling. Nail through the flooring into the floor joists at 6" on center.
6. Attach 2" x 8" upper wall plates to all four walls (Figure B). Butt the upper edges of the plates firmly against the lower edges of the existing lower truss members. Nail through the wall panels into the wall studs at 6" on center.

Attach 2" x 8" rafter doublers to every other rafter with nails at 6" on center. Position the doublers such that half of their width is suspended below the bottom of the existing lower truss members (Figure C). Dimension the length of each rafter doubler so that it fits snugly between the upper wall plates on either of its ends (Figure B).

FOR OFFICIAL USE ONLY

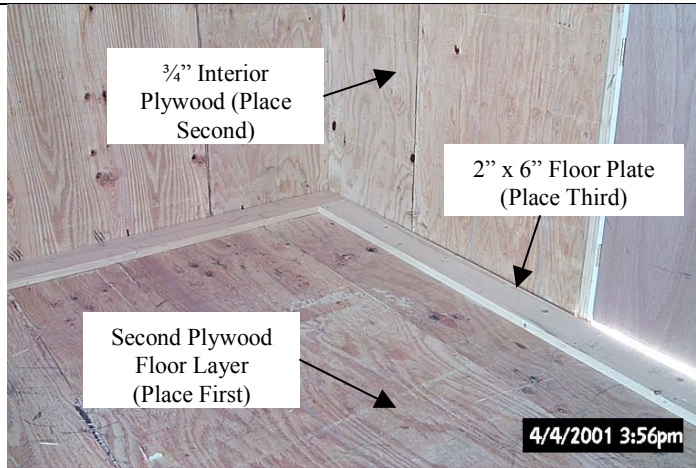

Figure A: 2" x 6" Floor Plate

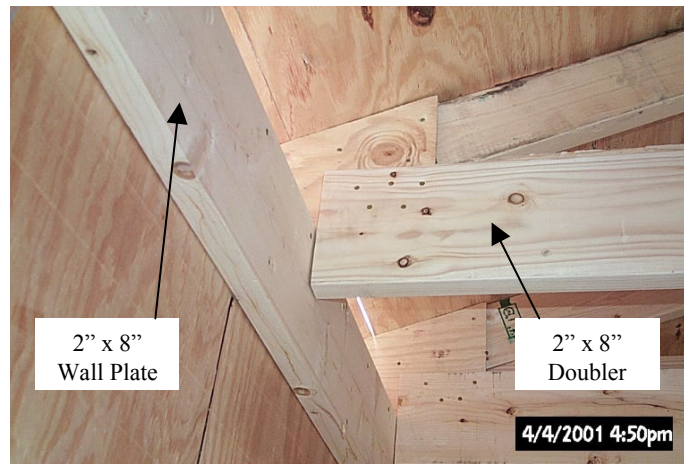

Figure B: 2" x 8" Upper Wall Plate

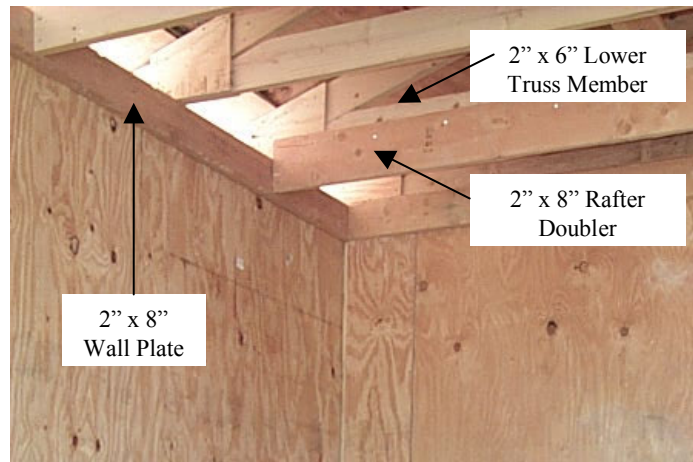

Figure C: 2" x 8" Rafter Doublers attached to every other 2" x 6" Truss Member

NOTES

FOR OFFICIAL USE ONLY

