

ORNS

**TC 5-31**

**DEPARTMENT OF THE ARMY TRAINING CIRCULAR**

---

**VIET CONG  
BOOBYTRAPS, MINES,  
AND MINE WARFARE  
TECHNIQUES**



---

**HEADQUARTERS, DEPARTMENT OF THE ARMY  
DECEMBER 1969**

**TAGO 7139A**

CHANGE

No. 1

HEADQUARTERS  
DEPARTMENT OF THE ARMY  
WASHINGTON, D.C., 13 June 1968

## VIET CONG ROOBYTRAPS, MINES AND MINE WARFARE TECHNIQUES

TC 5-31, 10 May 1967, is changed as follows:

Page 6, paragraph 4. Subparagraph *f* is superseded as follows:

*f. Soviet Model TM-46 Antitank Mine.* The Model TM-46 is the latest known Soviet antitank mine. It may be emplaced either by hand or by mechanical means. A pressure of about 400 pounds applied to the pressure plate compresses the striker spring in the fuze until the striker-retaining ball escapes into a recess in the pressure cap, thus releasing the spring-loaded striker. A version of the TM-46, the TMN-46, has a secondary fuze well located in the bottom of the case.

## CHARACTERISTICS (Model TM-46)

Type.....	Blast
Maximum diameter.....	12.2 in.
Height.....	2.9 in.
Weight.....	19.2 lb
Actuating force.....	400 lb
Case material.....	Sheet metal
Number of fuze wells.....	1
Main charge.....	TNT
Filler weight.....	12.6 lb
Fuze model.....	MV-5 or MV-5K
Fuze type.....	Pressure
Safety device.....	None

Page 10, paragraph 5. In subparagraph *g*, the last sentence is deleted and the following is added: "The VC produce the DH-10 mine in three sizes. They also produce a VC version of the U.S. M-18 Claymore mine, using captured U.S. M-18 mines as a model. The combination of the DH-10 and VC Claymore mines gives the VC a choice of both directional and area coverage weapons."

Page 11, paragraph 5. The first 12 lines of subparagraph *k* are superseded as follows:

*k. Mud Ball Mine.* The mud ball mine consists of a hand grenade encased in sun-baked mud or clay. The safety pin is removed and replaced by a 10-12-inch wire, and mud is molded around the grenade leaving the ends of the wire exposed. When

the mud hardens enough to hold the grenade safety lever in place, the wire is withdrawn, arming the grenade; however, the grenade will not detonate until its mud case is broken. The mud ball is placed on trails or anywhere troops may walk. Stepping on the ball breaks the dried mud and releases the safety lever detonating the grenade. A variation of this technique permits employment as a delayed bomb. The mud-encased grenade is placed in a canteen cup or other container. When the mud hardens enough to hold the grenade safety lever in place, the grenade is armed and the hardened mud case prevents the grenade from detonating. Upon withdrawal from an area, the container is placed where water might drain into it, under runoff from a roof, for example. When sufficient water drains into the container to make the mud pliable once again, the safety lever will release, and the grenade will detonate.

Page 12, paragraph 5. Subparagraphs *m* and *n* are added as follows:

*m. BLU-3B Bomb.* The BLU-3B bomb is a U.S. Air Force air-dropped antimaterial and anti-personnel bomb. A little larger than a man's fist, the BLU-3B consists of a removable tail fin assembly for stabilization in flight, a metal body with embedded pellets for fragmentation, and a pressure plate with striker for impact detonation. The swampy terrain and jungle cover in Vietnam have caused a number of the bomblets to fail to detonate. These duds have been recovered by the Viet Cong and later used as antipersonnel mines. The bomblets with tail fins removed have been buried, pressure plate up, in roadways and trails as pressure-activated antipersonnel mines; they have been fastened above ground to trees or bushes and initiated with homemade firing devices activated by pull on tripwires strung across a path; and have been modified by removing the pressure plate, enlarging the fuze well, and inserting an

electric blasting cap to be command-fired electrically, either singly or in clusters.

CHARACTERISTICS

Type.....	Antimateriel/antipersonnel
Color.....	Yellow with black lettering
Maximum diameter.....	2½ in.
Length.....	3¾ in. without fins
Total weight.....	2 lb
Filler.....	RDX

Figure 20.1 is added as follows:

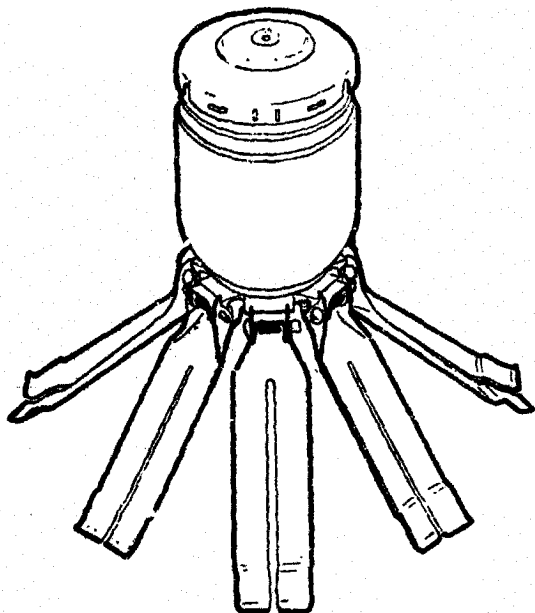

Figure 20.1 BLU-3B bomb.

*a. U.S. Butterfly Bomb.* These devices may be found in areas formerly held by enemy forces, where they were dropped by friendly aircraft. The bombs are equipped with various kinds of fuzes. They may be fuzed to detonate as they near the surface of the ground, on impact, or with a time delay. Some are fuzed to detonate after impact when touched or bumped. Even vibrations in the ground caused by a person walking nearby may cause them to explode. **LEAVE THESE BOMBS ALONE. DO NOT TOUCH THEM.** Only Explosive Ordnance Disposal units may remove or dispose of these bombs.

CHARACTERISTICS

Type.....	Antipersonnel
Color.....	OD with yellow markings
Maximum diameter.....	About 2½ in.
Length.....	About 3 in.
Total weight.....	4 lb
Filler.....	TNT

Figure 20.2 is added as follows:

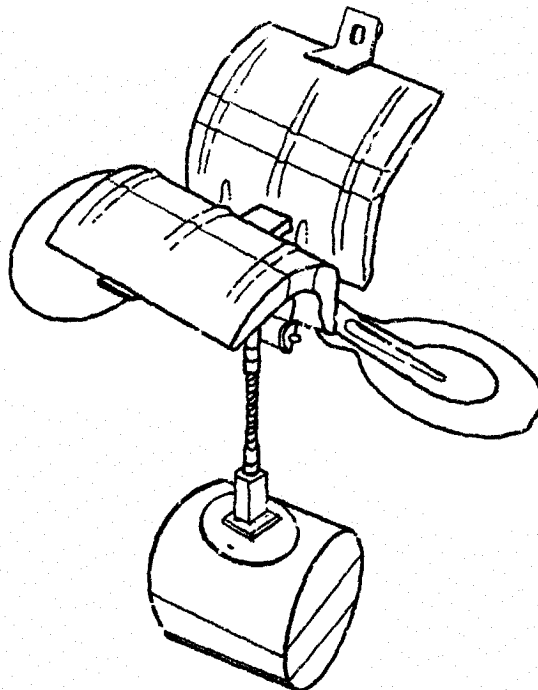

Figure 20.2. U.S. butterfly bomb.

Page 36, paragraph 12. Subparagraphs *d.1*, *d.2*, and *d.3* are added after subparagraph *d* as follows:

*d.1. Grenade Launcher.* The grenade launcher is an improvised antiaircraft weapon used against helicopters. A 3-pound charge of TNT is placed at the bottom of a funnel-shaped hole 2 feet in diameter and 2.5 feet deep in a potential helicopter landing zone. The charge is primed and tamped with earth to 4 inches from the surface. A board 2 feet square to which hand grenades are attached is placed over the hole. The grenades are held in place on the board between nails driven 3 inches apart. The nails also exert pressure against the

grenade safety levers to prevent their release when the safety pins are removed. The charge is command-detonated when a helicopter is about 100 yards above the device. The grenades are thrown

into the air to a height of 120 to 150 yards where they detonate and inflict damage to the helicopter and casualties among its crew and passengers.

Figure 56.1 is added as follows:



GRENADES

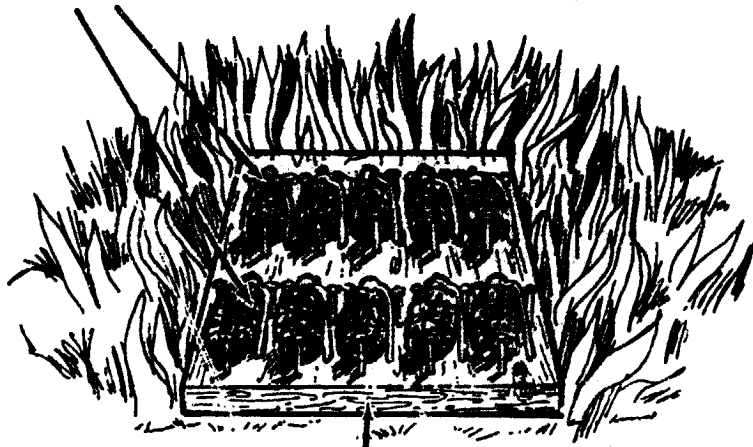

BOARD

Figure 56.1. Grenade launcher.

*d.2. Helicopter Trap.* Another method of employing hand grenades against helicopters is the helicopter trap. Bamboo poles are placed in the ground with a tin can attached to the top of each pole. Hand grenades with safety pins removed

are placed inside the cans. Trip wires are attached to the grenades from one pole to another in an "X" pattern. When a helicopter touches the trip wires, the grenades drop to the ground and explode.

TC 5-31  
C 1

Figure 56.2 is added as follows:

### HAND GRENADE INSIDE TIN CAN

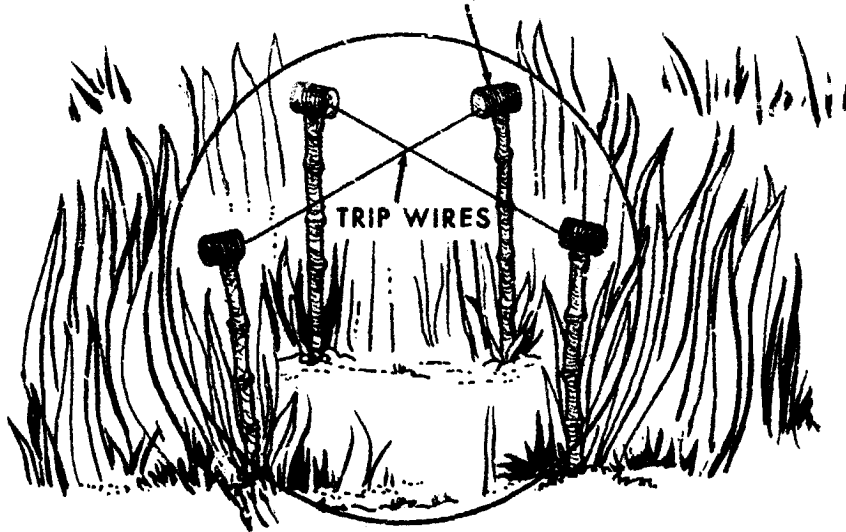

Figure 56.2. Helicopter trap.

d.3. *VC Boobytrap Grenade.* This is a manufactured boobytrap grenade that resembles a standard fragmentation hand grenade, except that the safety pin and the pivot pin have been reversed.

The grenade detonates when the safety pin is removed and pressure is applied to the safety lever.

Figure 56.3 is added as follows:

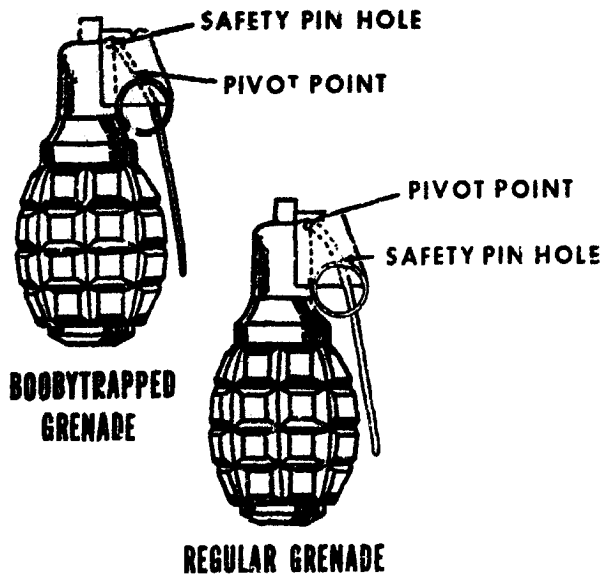

Figure 56.3. VC Boobytrap grenade.

Page 43, paragraph 12. Subparagraph *m* is added as follows:

*m. Gas Tank Grenade.* An explosive boobytrap used effectively by the Viet Cong to destroy vehicles is the gas tank grenade. The safety lever of a hand grenade is taped to the hand grenade body. The safety pin is then withdrawn, and the grenade dropped into the fuel tank of a vehicle after removing the gas cap and the fuel filter screen. When the adhesive of the tape has deteriorated in the fuel, the safety lever releases the spring of the firing device which detonates the grenade. Varying the kind of tape and the number

of times it is wrapped around the body and handle provides variation in the time delay element before detonation.

Page 44, paragraph 13. Subparagraph *a.1* is added after subparagraph *a* as follows:

*a.1. Crow's Foot.* The crow's foot is a four-pronged metal device, designed so that no matter how it is placed on the ground one spike will be facing up. The size of the device varies from 2 to 12 inches. All spikes are barbed. The crow's foot is used against both personnel and rubber-tired vehicles.

Figure 65.1 is added as follows:

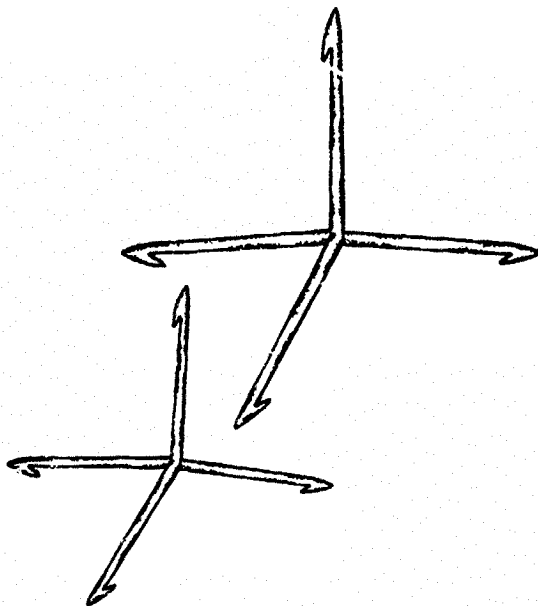

Figure 65.1. Crow's foot.

Page 53, paragraph 13. Subparagraph *o* is added as follows:

*o. Punji Stakes.* Punji stakes are pointed bamboo stakes, emplaced in the ground and covered with grass, used to injure unsuspecting persons who step or fall on them. The pointed ends are often treated with human excrement or poison so that the wounds may become infected or even cause death. The Viet Cong employ them in various

ways. They are often used on prospective landing zones to wound personnel as they jump from a helicopter to the ground. They are sometimes used as obstacles in Viet Cong defensive positions. Quite often they are emplaced on the banks of gullies and streams where it is likely that troops might jump from one bank to the other. They are generally used along roads at the entrances to villages or at ambush sites.

TC 5-31  
C 1

Figure 78.1 is added as follows:



*Figure 78.1. Punji stakes.*

Page 62. Paragraph 24 is superseded as follows:

**24. Reporting.** No mine or boobytrap incident should be considered too small or inappropriate to be reported.

a. Any knowledge or suspicion of an enemy minefield must be reported to the next higher command immediately. Further information on what action to take when enemy minefields are discovered may be found in paragraph 4-3, FM 20-32.

b. Enemy boobytrapped areas, when discovered, are also immediately reported to the next higher command. Boobytrapped areas, especially villages

and inhabited areas, should be bypassed, to be cleared by specialists later. Tactical units neutralize boobytraps only when necessary for continued movement or operation. Boobytraps that are not neutralized are marked by warning signs.

c. The destruction in place of mines and boobytraps should be reported by number, type, location, and circumstances under which they were destroyed.

d. The Standing Operating Procedure (SOP) of each unit should clearly define reporting procedures to insure completeness, accuracy, and conformity to the SOP of the major command.

By Order of the Secretary of the Army:

Official:

**KENNETH G. WICKHAM,**  
*Major General, United States Army,*  
*The Adjutant General.*

**HAROLD K. JOHNSON,**  
*General, United States Army,*  
*Chief of Staff.*

Distribution:

*Active Army:*

ACSI (2)  
DCSPER (2)  
DCSLOG (2)  
DCSOPS (2)  
CORC (2)  
CRD (1)  
COA (1)  
CINFO (1)  
TIG (1)  
CofEngrs (2)  
CNGB (2)  
USACDCEA (2)  
USACDCARMA (2)  
USACDCARTYA (2)  
USACDCCARMSA (2)  
USACDCIA (2)

USACDCSWA (2)  
USCONARC (5)  
USACDC (2)  
ARADCOM (2)  
LOGCOML (5)  
OS M&J Com: (5)  
USALSTC (2)  
MDW (1)  
Armies (25)  
Corps (15)  
Div (10)  
Div Arty (5)  
Bde (5)  
Regt/Gp (5)  
Bn (15)  
USACDCSWCAG (2)

USACDCCAG (2)  
Svc Colleges (2)  
Br Svc Sch (10) except  
USAES (50)  
TJAGSA (1)  
USMA (1)  
USAFSTC (2)  
USAINTC (2)  
PMS Sr Div Units (1)  
USATC (20) except USATC  
Engr (50)  
Units organized under following  
TOE's:  
5-127 (2)                      5-500 (KA) (1)  
5-137 (2)                      5-500 (KB) (1)  
5-500 (IG) (1)                5-500 (KC) (1)

*NG:* State AG (3); Units—same as active Army except allowance is (1) copy to each unit.

*USAR:* Units—same as active Army except allowance is (1) copy to each unit.

For explanation of abbreviations used, see AR 320-50.



TRAINING CIRCULAR }  
 No. 5-31 }

HEADQUARTERS  
 DEPARTMENT OF THE ARMY  
 WASHINGTON, D. C., 18 December 1969

## VIET CONG BOOBYTRAPS, MINES, AND MINE WARFARE TECHNIQUES

	Paragraph	Page
<b>SECTION I. INTRODUCTION</b>		
Purpose and scope .....	1-1	1-1
Comments .....	1-3	1-1
Introductory remarks .....	1-3	1-1
<b>II. MINES AND DEMOLITIONS</b>		
Antitank mines .....	2-1	2-1
Antipersonnel mines .....	2-3	2-5
Demolition charges .....	2-3	2-14
Water mines .....	2-4	2-17
<b>III. FUZES AND FIRING DEVICES</b>		
Fuzes .....	3-1	3-1
Firing devices .....	3-2	3-3
<b>IV. BOOBYTRAPS</b>		
Number and types .....	4-1	4-1
Hand grenades .....	4-2	4-1
Explosive boobytraps .....	4-3	4-6
Nonexplosive boobytraps .....	4-4	4-15
<b>SECTION V. MINE WARFARE DOCTRINE</b>		
General .....	5-1	5-1
Employment of antivehicular mines .....	5-2	5-3
Employment of antipersonnel mines .....	5-3	5-9
Employment of boobytraps .....	5-4	5-10
Employment of water mines .....	5-5	5-12
Employment of mines against helicopters .....	5-6	5-14
Marking of mines and boobytraps by the Viet Cong .....	5-7	5-15
<b>VI. DEFENSE AGAINST VIET CONG MINES AND BOOBYTRAPS</b>		
Training and discipline .....	6-1	6-1
Precautionary measures .....	6-2	6-1
Detection and search techniques .....	6-3	6-3
Immediate action upon mine activation .....	6-4	6-5
Disarming methods .....	6-5	6-6
Clearing non-explosive traps .....	6-6	6-7
Active mine prevention methods .....	6-7	6-8
Reporting .....	6-8	6-8
<b>INDEX</b> .....		Index-1

\*This training circular supersedes TC 5-31, 10 May 1967, including all changes.

## SECTION I

### INTRODUCTION

---

**1-1. Purpose and Scope.** *a.* This training circular is a guide for commanders and staffs in the orientation and training of personnel for operations in the Republic of Vietnam. It covers enemy mine and boobytrap materiel, techniques of employment, and defensive measures to be taken against enemy mine and boobytrap activities.

*b.* The material contained herein is applicable without modification to nuclear and nonnuclear warfare.

**1-2. Comments.** Users of this training circular are urged to submit recommended changes and comments to improve the publication. Comments should be keyed to the specific page, paragraph, and line of the text in which the change is recommended. Reasons should be provided for each comment to insure understanding and complete evaluation. Comments should be prepared using DA Form 2028 (Recommended Changes to Publications) and forwarded direct to the Commandant, U. S. Army Engineer School, Fort Belvoir, Virginia 22060.

#### **1-3. Introductory Remarks**

*a.* Enemy mining in the Republic of Vietnam is conducted by both the Viet Cong and the North Vietnam Army forces. Although the Viet Cong are responsible for the majority of mine and boobytrap incidents, the NVA forces have also employed them. In this training circular, the use of the term "Viet Cong" implies enemy forces of either Viet Cong or North Vietnamese origin.

*b.* The VC employ mines and boobytraps as a key weapons system in offensive and defensive roles and to interdict movement of U.S. and Allied forces throughout the Republic of Vietnam (RVN). Operational experience in RVN has clearly demonstrated that the VC are imaginative, resourceful, and tenacious in the use of mines and boobytraps. Continuous effort must be made in training programs to indoctrinate all personnel in defensive measures against mines and boobytraps in order to minimize personnel casualties and losses of materiel.

*c.* Viet Cong forces have developed a high degree of expertise in the use of mines and boobytraps in their own familiar environment. Employment techniques include the use of mines and boobytraps in defensive and offensive tactics; security of camp sites, villages, and other installations; ambush tactics, harassment, and terrorist activities. All available materiel, manufactured or locally produced, friendly or enemy, is used to best advantage. The Viet Cong know how to use mines and they use them effectively.

*d.* Detailed discussion of materiel and equipment in this circular is confined to that of foreign origin: Viet Cong, North Vietnamese, Soviet, and Chinese Communist. It must be emphasized, however, that Viet Cong forces make extensive use of captured U. S. materiel and equipment. Where appropriate, this is so noted in the text. U. S. mines, fuzes, and related materiel are adequately covered in other Department of the Army publications (FM 5-31, FM 20-32, TM 9-1345-200).

*e.* The objective of this training circular is to provide adequate orientation and recognition data on mines, demolitions, fuzes, firing devices, boobytraps, and employment techniques of Viet Cong forces. A section is devoted to recommended defensive measures against VC mines and boobytraps. Although this circular may not include all possible materiel and devices used by the Viet Cong, there are sufficient data to establish a reasonable pattern of operation. Innovations on a given technique may vary widely, but the Viet Cong will not differ greatly from the general pattern.

*f.* Viet Cong equipment and materiel are discussed in the circular under the definitive titles of antitank mines, antipersonnel mines, demolition charges, water mines, fuzes, firing devices, and boobytraps. As a practical matter, VC materiel and employment techniques do not follow such closely defined titles. For example, mines may be used in either antitank, antivehicular, or antipersonnel roles; demolitions charges and artillery shells are used in a variety of ways; and the dis-

inction between antipersonnel mines and boobytraps is often academic. Users of this circular should learn what materiel and devices are actually being used by the VC for various purposes, and not attempt to place them into academic and

inflexible categories. The names applied to individual mines and boobytraps in this circular are those most commonly used; however, some units or agencies may refer to them under different names.

## SECTION II

### MINES AND DEMOLITIONS

2-1. Antitank Mines. Viet Cong antitank or anti-vehicular mines vary considerably, and any encased explosive charge of adequate size may be employed. Explosive charges for the purpose range from crude, locally produced items to artillery shells and captured U. S. mines, as well as to Soviet and Chinese Communist mines. Included in this section are mines either known to have been used by the Viet Cong or readily available to them.

a. *Soviet Model TMB-2 Antitank Mine.* The Soviet model TMB-2 antitank mine (fig. 2-1) is designed to make electronic detection difficult if not impossible. It is encased in tar-impregnated cardboard, sealed with tape and a coating of asphalt. Pressure on the mine activates an MV-5 fuze under the glass pressure plug located on the top of the mine and explodes the mine. The TMB-2 antitank mine is brownish in color with a blue glass pressure plug. Model TMSB, a later modification of the basic TMB-2, is slightly larger and contains more explosive. Both models are similar in function and design. Arming and disarming instructions are found in TM 5-280. The safest procedure, however, is to destroy the mine in place.

#### CHARACTERISTICS

Shape .....	Circular
Fuze .....	MV-5 (pressure)
Diameter TMB-2 .....	10.8 in.
TMSB .....	11.3 in.
Height TMB-2 .....	6.1 in.
TMSB .....	6.6 in.
Explosive main charge .....	Powered amatol 80/20
Booster .....	Paper wrapped cylindrical TNT
Explosive weight TMB-2 .....	11 lb (approx)
TMSB .....	13 lb (approx)

b. *Soviet Model TM-41 Antitank Mine.* This is a metal cased mine fitted with an MV-5 pressure fuze (fig. 2-2). Some modifications of the original design have appeared, such as changes in the number of radial ribs on the lid, the size and location of the filling plug, and the number of corrugations around the top side. Pressure on the top of the lid crushes the corrugated sides of the lid, de-

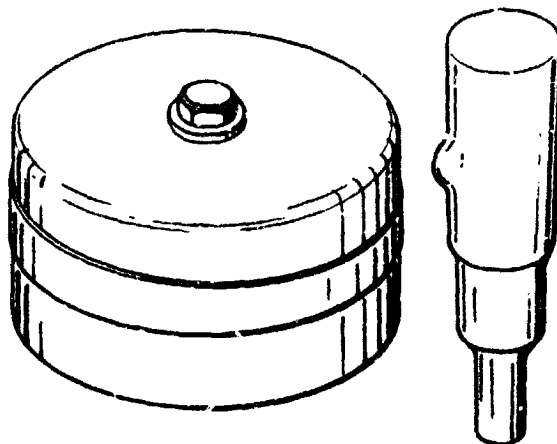

Figure 2-1. Soviet model TMB-2 antitank mine and MV5 fuze.

pressing the sliding head of the MV-5 fuze until it functions and detonates the mine.

#### CHARACTERISTICS

Shape .....	Circular
Fuze .....	MV-5 (pressure)
Diameter .....	10 in.
Height .....	5.8 in.
Explosive main charge .....	Amatol 80/20 or flaked TNT
Booster .....	Picric acid
Explosive weight .....	8.6 lb
Operating force .....	400-440 lb (approx)

c. *Soviet Model TM-46 Antitank Mine.* The model TM-46 is the latest known Soviet antitank mine. It is detonated by an MV-5 pressure fuze and the mine requires a 400-pound force for activation. A version of the TM-46, the TMN-46 (fig. 2-3) has a secondary fuze well located in the bottom of the case. In both models, the case material is sheet steel.

#### CHARACTERISTICS

Shape .....	Circular
Fuze .....	MV-5 or MV-5K (pressure)
Diameter .....	12.2 in.
Height .....	2.9 in.

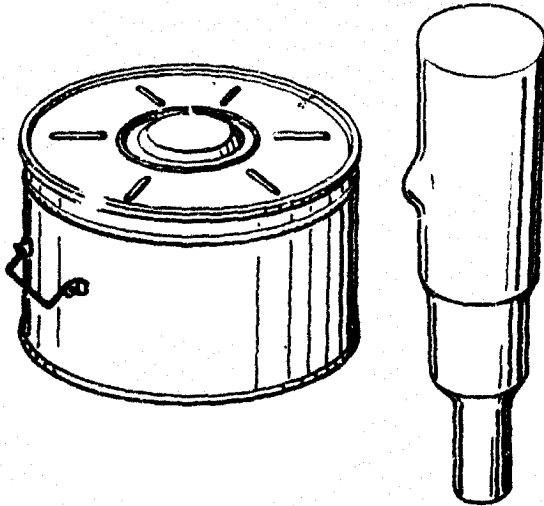

Figure 2-2. Soviet model TM-41 antitank mine.

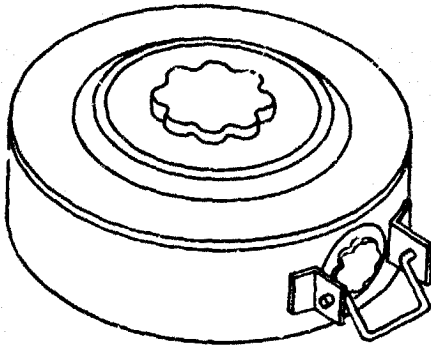

Figure 2-3. Soviet model TMN-46 antitank mine.

CHARACTERISTICS (Continued)

Weight	19.2 lb
Explosive main charge	TNT
Explosive weight	12.6 lb
Operating force	400 lb (approx)
Boosters	37.8 grms tetryl, primary well 42.1 grms tetryl, secondary well

d. *Chinese Communist No. 4 Dual Purpose Mine.* The Chinese No. 4 dual purpose mine (fig. 2-4) was designed for use against both personnel and light vehicles. A threaded fuze well is located in the top center of the mine. It incorporates a double acting fuze which will initiate the explosive charge under either of two circumstances: when a load of 300 to 500 pounds is applied to the pressure spider or when a pull of 10 to 50 pounds is applied to the fuze's striker-retaining pin. With its pressure spider, the mine is similar in appearance to the obsolete U. S. antitank mine M-1A1.

CHARACTERISTICS

Shape	Circular
Fuze	Dual purpose, pressure or pull
Diameter	9 in.
Height	4 in.
Explosive main charge	flaked TNT
Explosive weight	5 lb
Operating force pressure	300 to 500 lb
pull	10 to 50 lb

e. *Chinese Communist Antitank Mine.* The Chinese Communist antitank mine (fig. 2-5) has a very thin sheet steel case with provisions for attaching a pressure plate or spider. The pressure plate is a sheet metal disk with four 1.75-inch diameter holes located 90° apart on the plate surface. A hole in the center of the pressure plate provides access to the fuze and fuze well. Four lugs welded to the outer edge of the pressure plate 90° apart prevent the plate from misaligning with the body when the mine is being emplaced. These lugs also act as guides for the downward movement of the pressure plate when a load is applied. All joints are lap welded and the inside of the mine case is sprayed with an asphalt type paint. This flat, cylindrical mine, painted olive drab, has no other markings or identifying features. The Viet Cong locally manufacture a similar antitank mine with iron case. The explosive filler for both mines is TNT.

CHARACTERISTICS

(Chinese Communist Model)

Maximum diameter	7.88 in.
Height	2.88 in.
Weight	11 lb with pressure plate and fuze
Case material	sheet steel
Case thickness	.08 in.
Case weight	5.75 lb
Fuze wells	1 main
Main charge	TNT
Filler weight	3.5 lb
Fuze type	Pressure
Safety device	Fork

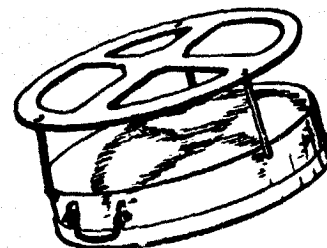

Figure 2-4. Chinese Communist No. 4 dual purpose mine and fuze.

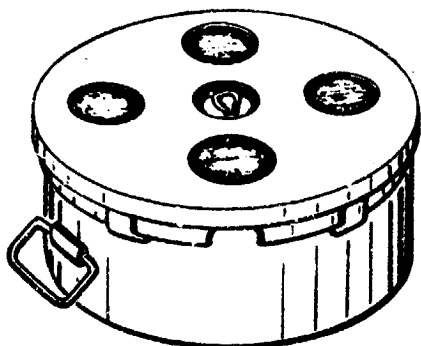

Figure 2-5. Chinese Communist and Viet Cong antitank mine.

often used as a mine. It can be detonated by either electrical or mechanical fuzes (with or without delay). The mine illustrated utilizes a mechanical fuze. When used as a demolition charge, this mine is normally coupled to a pole.

CHARACTERISTICS

Color .....	Gray
Fuze .....	Electrical/mechanical
Diameter .....	5 in. (end is semicircular)
Length .....	9 in.
Overall weight .....	13 lb
Explosive .....	TNT

*h. Dud Shell Mine.* The dud shell mine (fig. 2-8) is improvised from a dud artillery or mortar projectile. The mine is made by removing the fuze from a projectile and drilling a hole into the explosive for an electric detonator. Batteries or a hand-held generator supply the current to activate the detonator. The mine is usually found along roads or trails. Its effectiveness against armored vehicles and personnel varies with the type and size of projectile used.

*i. Shaped Charge Mine.* The Viet Cong improvise a great variety of shaped charge mines for use against both personnel and vehicles. The mine is generally constructed of sheet metal. Sheet metal is also used to form the explosive cone required for the shaped charge effect. This mine

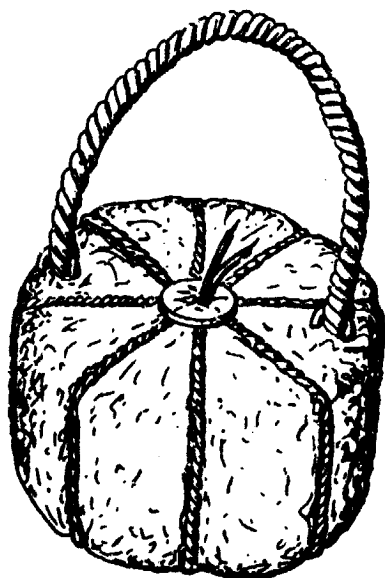

Figure 2-6. Betal mine.

*f. Betal Mine.* The Betal box mine (fig. 2-6) is constructed of concrete and explosive. Its one fuze well is located on the top at the center of the mine. Used in either an antivehicular or an antipersonnel role, the mine is usually exploded by an electric detonator. Other fuzes also may be used.

CHARACTERISTICS

Type .....	Antipersonnel/antivehicular
Color .....	Gray
Maximum diameter .....	8 in.
Height .....	7 in.
Total weight .....	13 lb
Filler .....	TNT

*g. Turtle Mine.* The turtle mine (fig. 2-7) is constructed of concrete encasing explosive. It is designed primarily as a demolition charge but is

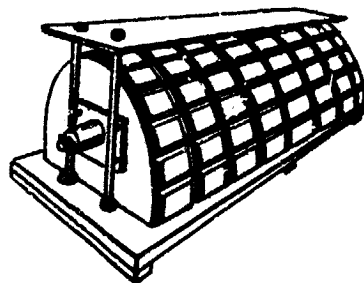

Figure 2-7. Concrete turtle mine.

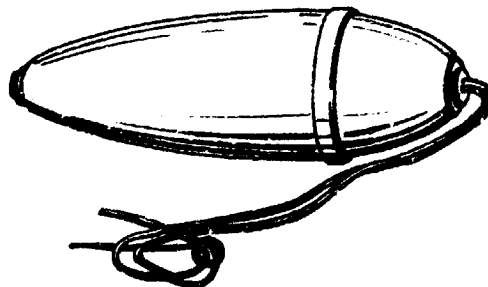

Figure 2-8. Dud shell mine.

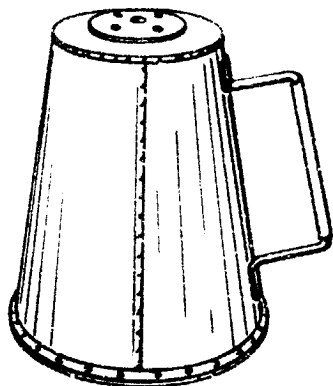

Figure 2-9. Shaped charge mine.

(fig. 2-9) is normally employed with two friction pull igniters or fuzes to increase the reliability of detonation. Size and characteristics are varied with the intended use.

*j. Locally Fabricated Viet Cong Mines.* The Viet Cong have shown considerable ingenuity in the fabrication of simple, yet effective, mines. Intelligence sources indicate that the Viet Cong depend to a great extent on materials discarded or lost by U. S. and South Vietnamese personnel. The VC/NVA uses U. S. weapons, ammunition, mines, grenades, and demolitions not only for their original purpose but also in the preparation of expedient mines and boobytraps. He is known to reuse extracted bulk explosive from captured duds or ordnance. Due to the minute amounts of metal used, the most difficult mines to detect are those with electrical firing systems. Such devices are usually powered by batteries, and the enemy frequently uses U. S. batteries. Virtually every military battery discarded by U. S. forces, including the common flashlight battery, is capable of being employed in electrical firing systems even after it is no longer usable for its original purpose. These facts emphasize the continuing necessity for all units to exercise every precaution to prevent friendly ordnance and batteries from falling into enemy hands. Batteries should be crushed or totally destroyed before discarding to prevent their use against Free World military forces. The two designs shown in figures 2-10 and 2-11 are both characterized by low metal content and maximum indigenous material.

*k. Plastic Antitank Mine PM50.* An East German mine constructed of plastic and nonmetallic materials (fig. 2-12) is being employed against Free World forces in Vietnam. The mine has a pressure activated mechanical fuze and con-

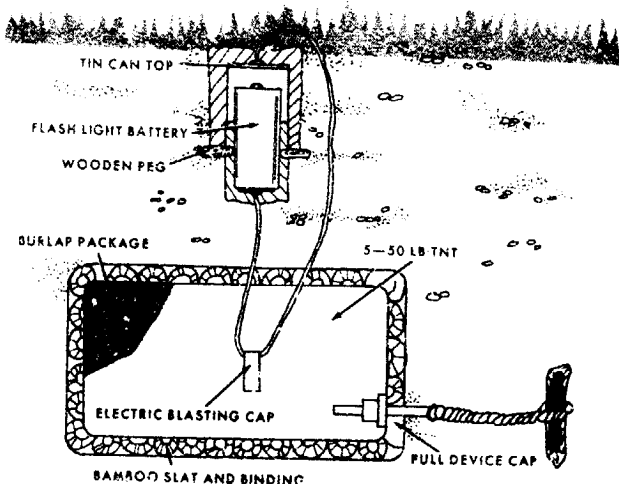

Figure 2-10. Typical locally fabricated VC mine (electrical detonation).

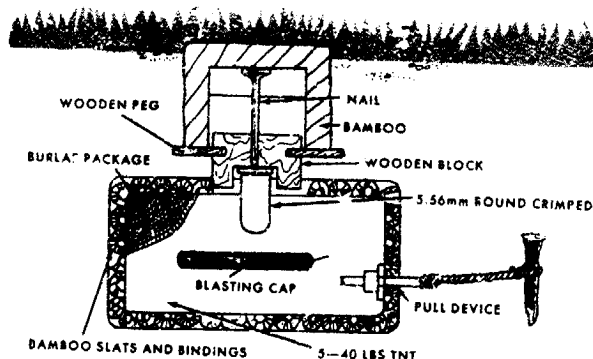

Figure 2-11. Locally fabricated VC mine (mechanical detonation).

tains provisions for a secondary firing device. The secondary device has a secondary booster and fuze well located in the bottom of the mine. This mine contains no metallic components and is extremely hard to detect when properly placed. The weight of the explosive filler (22 pounds of TNT) will provide a mobility kill on any known tank and will destroy wheeled or light tracked vehicles.

CHARACTERISTICS

Color .....	Olive drab
Shape .....	Circular
Diameter .....	12.6 in.
Main explosive .....	TNT
Weight (w/booster) .....	25.0 lb
Weight of explosive .....	22 lb
Fuze .....	Main: pressure mechanical
	Secondary: no standard permanent model

downward, hitting the primer and detonating the mine. This mine should never be neutralized by hand because of the possibility of a hangfire.

#### CHARACTERISTICS

Color	Gray or green
Maximum diameter	3 in.
Height	6 in.
Total weight	Approx 2 lb
Filler	TNT
Fuze delay	None

*b. Concrete Fragmentation Mine.* The concrete fragmentation mine (fig. 2-14) is constructed of explosive encased in cylindrically shaped concrete with a flat side for stable emplacement. A 2-inch diameter pipe on one end of the mine head serves as a carrying handle and detonator housing. The two swivels on top of the mine are used to tie it to an object. The mine's electrical detonator usually is activated remotely by means of a battery pack or handheld generator.

#### CHARACTERISTICS

Color	Gray
Length of mine body	10 in.
Width of base	7 in.
Height	6 in.
Total weight	13 lb
Filler	TNT
Fuze delay	None

*c. Concrete Mound Mine.* The concrete mound mine (fig. 2-15) is usually constructed of explosive encased in concrete, but possibly a similar mine of cast iron may be encountered. The mound-shaped mine is electrically fuzeed and has two fuze wells, one at each end. The iron pipe at one end of the mine serves as a pole socket, as well

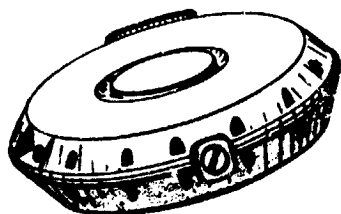
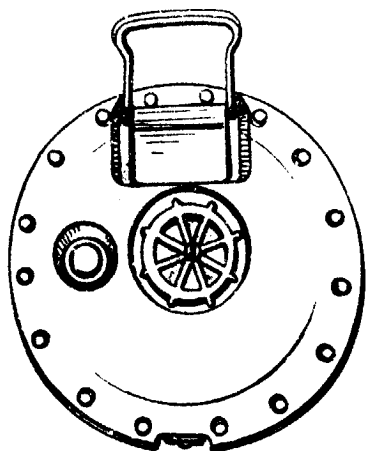

Figure 2-12. Plastic antitank mine PM 60.

**2-2. Antipersonnel Mines.** The number and type of Viet Cong antipersonnel mines vary as much as or more than the antitank mines. A significant feature of the antipersonnel mines is that nearly all of them are improvised. Artillery and mortar shells, antitank mines, hand grenades, and various other explosive charges are adapted by the Viet Cong for use as antipersonnel mines in an almost unlimited variety of employment techniques. The antipersonnel mines described in this section are typical of Viet Cong innovation and improvisation.

*a. Tin Can Antipersonnel Mine.* The tin can mine (fig. 2-13) is constructed from a sheet metal container similar in appearance to a beer can. The firing device for the explosive is an improvised fuze with zero delay. A hand grenade fuze with the delay element removed may be used with this munition. The mine functions by a tripwire attached to the pull ring device, which when removed allows the spring-driven striker to move

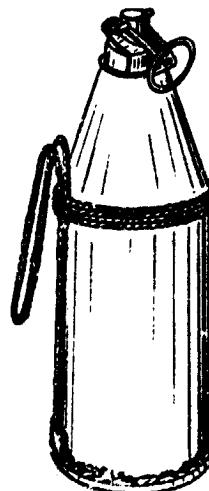

Figure 2-13. Tin can antipersonnel mine.



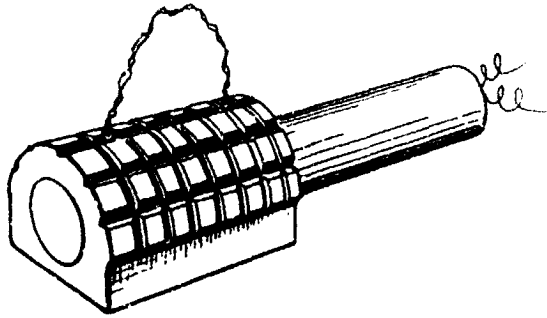

Figure 2-14. Concrete fragmentation mine.

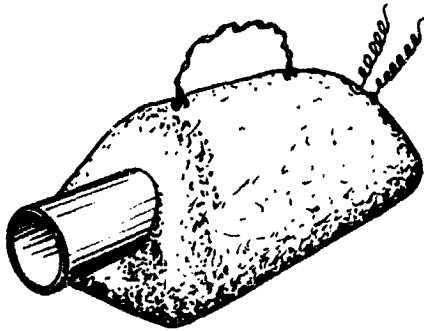

Figure 2-15. Concrete mound mine.

as being a housing for one of the fuze wells. Electric current to activate the detonator is provided by a battery pack or handheld generator.

**CHARACTERISTICS**

Color .....	Gray
Maximum diameter .....	5.5 in.
Length .....	14 in.
Total weight .....	13 lb
Filler .....	TNT
Fuze delay .....	None

*d. Cast Iron Fragmentation Mine.* This oval shaped mine (fig. 2-16) is crisscrossed by serrations except on the two ends. On the mine body, between the ends, is a handle attached to two eye hooks. The mine has a single fuze well, 2 inches in diameter, located on one end of the mine. This fuze well is covered until arming, when an electric blasting cap is inserted into the fuze well.

**CHARACTERISTICS**

Color .....	Gray
Maximum diameter .....	5 in.
Length .....	9 in.
Total weight .....	12 lb
Filler .....	Melinite/TNT

*e. Cast Iron Fragmentation Mine, AP.* This antipersonnel mine (fig. 2-17), made of cast iron,

resembles a stick hand grenade with a very short handle. The word *MIN* is often found cast into the body. The handle houses a pull-friction fuze which may or may not have a delay element. A tug on a tripwire attached to the pull wire of the friction fuze will, by extracting the pull wire, fire the munition.

**CHARACTERISTICS**

Color .....	Gray to black
Maximum diameter .....	2 in.
Length .....	6.5 in.
Total weight .....	2.2 lb
Filler .....	TNT
Fuze delay .....	2 to 4 sec

*f. Bounding Fragmentation Mine.* The bounding fragmentation mine (fig. 2-18) is improvised from U. S. M2 bounding-mine or M48 trip-flare mine cases. A wooden cylinder, slightly smaller in diameter than the mine case, is hollowed out so that a standard grenade (frequently the U. S. M26) can fit inside. The wooden cylinder, with inclosed grenade, is then fitted into the mine case and the grenade's safety pin is extracted. When

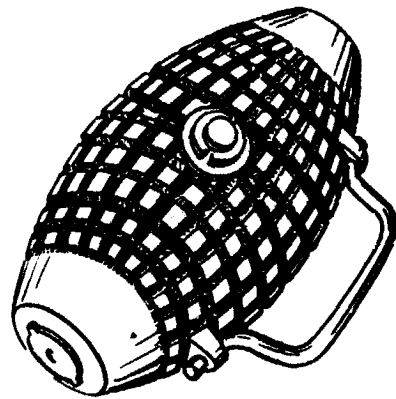

Figure 2-16. Cast iron fragmentation mine.

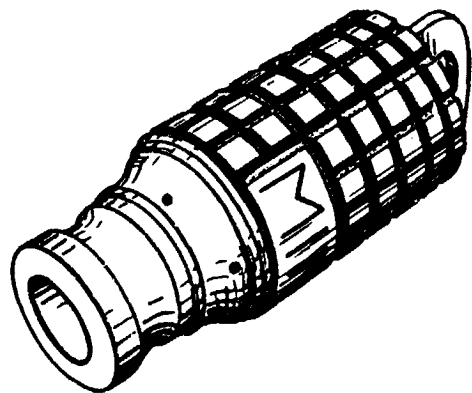

Figure 2-17. Cast iron fragmentation mine, AP.

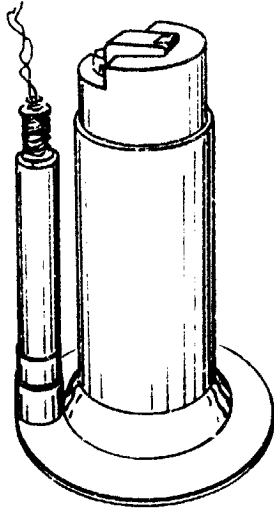

Figure 2-18. Bounding fragmentation mine.

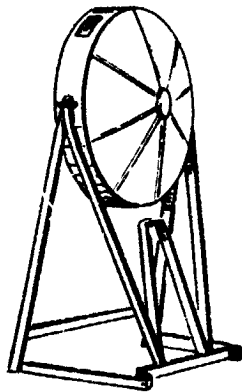

Figure 2-19. Directional fragmentation mine (DH-10).

the mine is initiated electrically, either by a battery pack or a hand generator, the cylinder and grenade are propelled upward. As the wooden cylinder with grenade leaves the case, the handle flies off and initiates the fuze train of the grenade.

#### CHARACTERISTICS

Color .....	Olive-drab or gray
Maximum diameter .....	2.5 in.
Height .....	8 in.
Total weight .....	5 lb
Filler .....	Grenade (TNT)
Fuze delay .....	3 to 4 sec (grenade)

*g. Directional Fragmentation Mine (DH-10).* This directional mine (fig. 2-19) is primarily an antipersonnel mine which also can be used against thinskin vehicles or similar items. The concave front or fragmentation face of the mine contains

approximately 450 half-inch steel fragments embedded in a matrix, and is backed up by cast TNT. Designed for electrical detonation, the mine is provided with an adjustable frame so that it can be placed on various types of surfaces and aimed in any direction. The single fuze well is centered on the convex (back) side of the mine. The Viet Cong produce the DH-10 mine in three sizes. Using captured U. S. M18 mines as models, the Viet Cong also produce a version of the U. S. M18 Claymore mine. The combination of the DH-10 and Viet Cong Claymore mines gives the Viet Cong a choice of both directional and area coverage weapons.

#### CHARACTERISTICS

Color .....	Gray to black
Maximum diameter .....	18 in.
Width .....	4 in.
Total weight .....	20 lb
Filler .....	Cast TNT

*h. Miniature Directional Fragmentation Munitions.* The evolution of the directional fragmentation mine introduced in Vietnam in 1964 has led to three new standard items utilizing the same principle. The original directional fragmentation mine (the DH-10) is extremely large, uses excessive material, and is difficult to conceal. Successes achieved with this weapon resulted in refinements, especially in size, in the basic design. The three latest munitions to appear are the saucer shaped DH3 and DH5 and the rectangular DH3. Each munition appears to be well constructed in accordance with established ordnance design principles. It is estimated that the effectiveness of these new munitions would be equivalent to a 12 gauge shotgun fired at a comparative range. The size reduction makes these miniature weapons more suitable for guerrilla tactics. It will allow for wider distribution and use, particularly in cities. It will effect a considerable savings in materials and logistics.

(1) *Miniature directional fragmentation munition, DH-3 (circular or saucer shaped).* This munition (fig. 2-20) is a circular or saucer shaped, directional fragmentation munition made of sheet metal, painted light gray. A painted dark green arrow points in the direction the munition is intended to be fired. The booster charge is Chinese Communist plastic explosive with the cap well formed by a mandrel. The cap well is offset from the side of the body laterally to the back surface of the munition. This permits a maximum explosive payload between the blasting cap and the fragments. The front concave surface of the

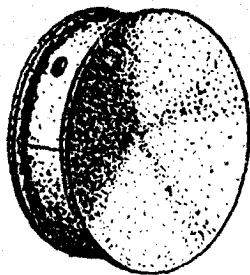

Figure 2-20. Miniature DH-3 (saucer or circular).

munition contains the fragments, while the back convex surface contains the explosive. The sheet metal casing is crimped together. The fragments are sections of large nails embedded in a paraffin matrix. These fragments are placed in the munition in two layers forming a flat random pattern. A paper disk, cut to the diameter of the munition, separates the explosive from the fragments.

**CHARACTERISTICS**

Color .....	Light gray
Shape .....	Circular or saucer shaped
Diameter .....	2½ in.
Thickness .....	15/16 in.
Explosive filler .....	Cast tritonal or H-6
Booster charge .....	Chinese Communist plastic explosive
Fragmentation .....	5/16 in. long, ¼ in. diameter
Case material .....	Sheet metal
Fuze well .....	One, inside of mine
Fuzing .....	Blasting cap
Distinctive marking .....	DH-3 painted in white paint

(2) *Miniature directional fragmentation munition DH-5 (circular or saucer shaped)*. This munition (fig. 2-21) is a circular or saucer shaped, directional fragmentation munition made of sheet metal, painted dark green. A painted white arrow points in the direction the munition is intended to be fired. The booster cavity is filled with plastic explosive and contains two cap wells. One well is formed by a mandrel passing through the center of the munition in the same manner as the DH-10 mine. Another cap well is formed by a mandrel passing laterally through the side of the munition. The lateral cap well is offset toward the back surface of the munition to insure a maximum explosive payload between the blasting cap and the fragments. The front concave surface of the munition contains the fragmentation while the back convex surface contains the explosive. The sheet metal casing surfaces are crimped together. The fragments are preformed metal sections of generally uniform size in a paraffin matrix. These fragments are placed in the munition in two

layers, forming a random pattern. Each layer lies flat for a maximum fragmentation payload, occupying a minimum of space. A paper disk, cut to the diameter of the munition, separates the fragments and the explosive.

**CHARACTERISTICS**

Shape .....	Circular or saucer shaped
Diameter .....	4½ in.
Thickness .....	1½ in.
Explosive filler .....	Cast tritonal or H-6
Booster charge .....	Chinese Communist plastic explosive
Fragmentation .....	Forged iron bar sections, 5/16 in. long, 5/16 in. wide, and ¼ in. thick.
Case material .....	Sheet metal
Fuze wells .....	Two, one passing through the center axis, the other passing laterally through the munition.
Fuzing .....	Blasting cap
Distinctive marking .....	DH-5 painted in white paint

(3) *Miniature directional fragmentation munition DH-3 (rectangular shaped)*. This munition (fig. 2-22) is a rectangular shaped, directional fragmentation munition made of sheet metal, painted flat white or gray. A painted black arrow points in the direction the munition is intended to be fired. The explosive filler cast tritonal or H-6, is cast around the booster charge. The booster charge is made from a section of Chinese Communist 200 gram TNT block. This booster charge is placed diagonally across the munition. A single cap well has been drilled into the TNT block. The front concave surface of the munition contains the fragments, while the flat back surface contains the explosive. The sheet metal casing is crimped together. These fragments are placed in the munition, in two layers, embedded in a paraffin matrix. The convex surface of the metal plate is next to the explosive filler, forming a fragmentation cavity.

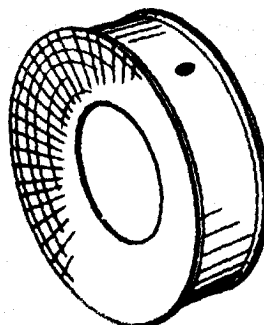

Figure 2-21. Miniature DH-5 (circular or saucer shaped).

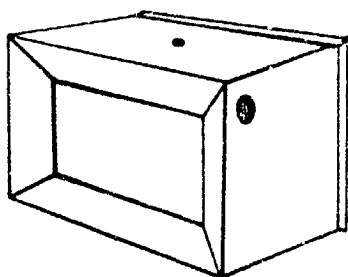

Figure 2-22. Miniature DH-3 (rectangular).

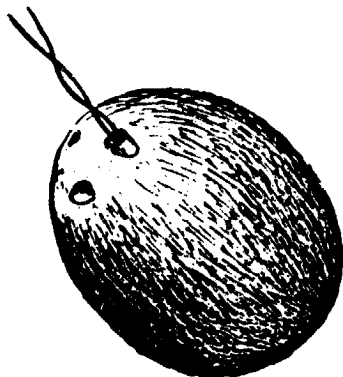

Figure 2-23. Coconut type mine.

**CHARACTERISTICS**

Color .....	Flat white to gray
Shape .....	Rectangular
Length .....	2½ in.
Width .....	2 in.
Thickness .....	1 in.
Explosive filler .....	Cast tritonal or H-6
Booster charge .....	Chinese Communist TNT
Fragmentation .....	Metal nail section, 5/16 in. long, ¼ in. diameter
Case material .....	Sheet metal
Fuze well .....	One fuze well, diagonally along the long axis of the munition
Fuzing .....	Blasting cap
Distinctive marking .....	DH-3 painted in black paint

*i. Coconut Type Mine.* This mine (fig. 2-23) is made from a hollowed out coconut filled with black powder. Using a friction type fuze, this mine is employed in much the same manner as hand grenades when used as an antipersonnel mine. It is usually buried approximately 6 inches underground, and it has been covered by rock or brick for missile effect. These mines have been used effectively near gates.

**CHARACTERISTICS**

Color .....	Brown
Size .....	Varies
Weight .....	Varies

**CHARACTERISTICS (Continued)**

Filler .....	Black powder
Fuze .....	Pull-friction

*j. Hollow Bamboo Mine.* This mine (fig. 2-24) is made from a large piece of bamboo. It is hollowed out and filled with plastic explosive or black powder, together with nuts, bolts, rocks, scrap, or other available material for missile effect. A pull-friction fuze is normally used. This mine may be command detonated with an electrical firing system. It has been used as an improvised demolition charge.

**CHARACTERISTICS**

Type .....	Antipersonnel
Color .....	Light tan (bamboo)
Diameter .....	2 to 6 in.
Length .....	Approx 2.5 ft
Weight .....	Varies
Filler .....	Black powder/plastic explosive
Fuze .....	Pull-friction

*k. Viet Cong "Toe Popper" Mine.* This mine (fig. 2-25) is fabricated of cartridge cases or pieces of pipe of various sizes. It is loaded with a charge of black powder, a primer, and a variety of fragments for missile effect. When the intended victim steps on the mine, the igniter explodes the black powder charge and propels the fragments upward.

**CHARACTERISTICS**

Type .....	Antipersonnel
Color .....	Varies
Size .....	Varies
Weight .....	Varies
Filler .....	Black powder
Fuze .....	Improvised primer

*l. Mud Ball Mine.* The mud ball mine (fig. 2-26) consists of a hand grenade encased in sunbaked mud or clay. The safety pin is removed and replaced by a 10-12 inch wire. Then mud is molded around the grenade leaving the ends of the wire exposed. When the mud hardens enough to hold the grenade safety lever in place, the wire is withdrawn, arming the grenade. However, the grenade

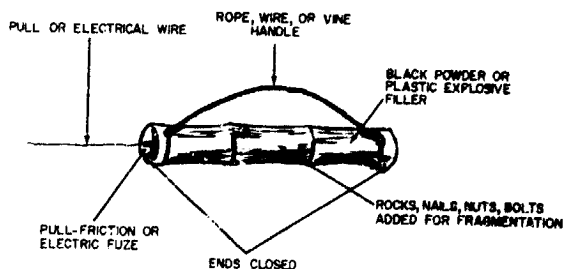

Figure 2-24. Hollow bamboo mine.

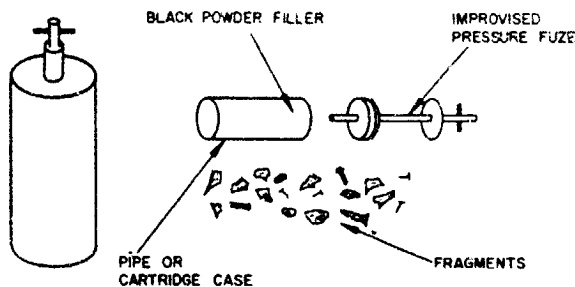

Figure 2-25. Viet Cong "toe popper" mine.

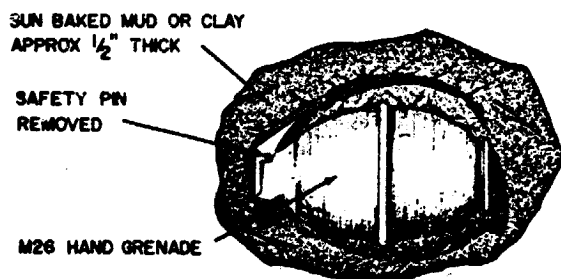

Figure 2-26. Mud ball mine.

will not detonate until its mud case is broken. The mud ball is placed on trails or anywhere troops may walk. Stepping on the ball breaks the dried mud and releases the safety lever detonating the grenade. A variation of this technique permits employment as a delayed bomb. The mud cased grenade is placed in a container such as a canteen cup. When the mud hardens enough to hold the grenade safety lever in place, the grenade is armed and the hardened mud case prevents the grenade from detonating. Upon withdrawal from an area, the container is placed where water might drain into it, under runoff from a roof for example. When sufficient water drains into the container to make the mud pliable once again, the safety lever will release, and the grenade will detonate.

**CHARACTERISTICS**

Type .....	Antipersonnel
Color .....	Varies with color of mud
Size .....	Approx 6-in. diameter
Weight .....	Varies with type of grenade and mud
Filler .....	TNT (grenade)
Fuze .....	Grenade fuze

*m. Shell Case Mine.* The shell case mine (fig. 2-27) utilizes a standard artillery shell casing, usually 75-, 105-, or 155-mm caliber, as an explosive container. A variety of fuzing mechanisms

can be improvised for this mine; the mine illustrated in figure 2-27 is detonated by the potato-masher grenade inserted into the explosive charge. Inserted into the side of the casing are two fuze wells through which electrically or mechanically initiated fuzes may be placed. The mine, generally used in an antipersonnel role, is initiated by a pull on a tripwire strung across a path. In an antivehicular role, the mine is usually command-fired electrically.

**CHARACTERISTICS**

Color .....	Brass
Maximum diameter .....	6 in.
Length .....	18 to 24 in.
Total weight .....	10 to 15 lb
Filler .....	TNT
Fuze delay .....	3 to 4 sec (with grenade)

*n. BLU-3B Bomb.* The BLU-3B bomb (fig. 2-28) is a U. S. Air Force airdropped antimateriel and antipersonnel bomb. A little larger than a man's fist, the BLU-3B consists of a removable tail fin assembly for stabilization in flight, a metal body with embedded pellets for fragmentation, and a pressure plate with striker for impact detonation. The swampy terrain and jungle cover in Vietnam have caused a number of the bomblets to fail to detonate. These duds have been recovered by the Viet Cong and later used as antipersonnel mines. The bomblets with tail fins removed have been buried, pressure plate up, in roadways and trails as pressure activated antipersonnel mines; they have been fastened above ground to trees or bushes and initiated with homemade firing devices activated by pull on tripwires strung across a path; and they have been modified by removing the pressure plate, enlarging the fuze well, and inserting an electric blasting cap to be command-fired electrically, either singly or in clusters.

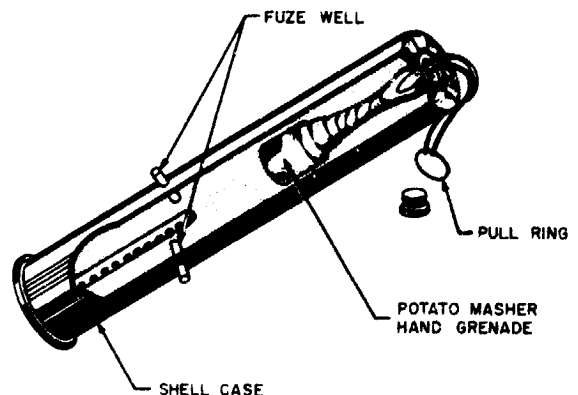

Figure 2-27. Shell case mine.

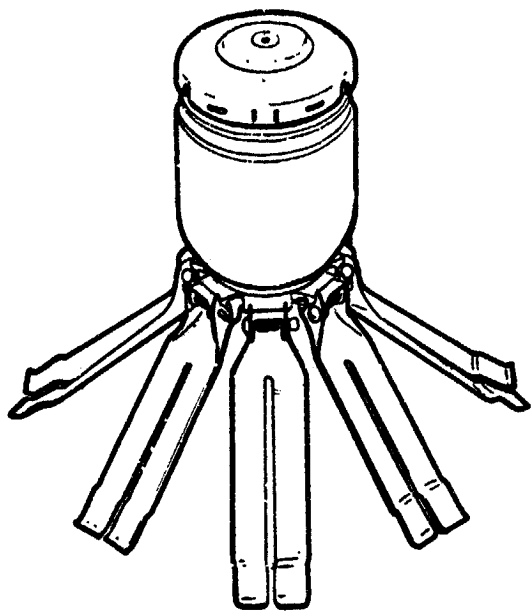

Figure 2-28. BLU-3B bomb.

## CHARACTERISTICS

Color .....	Yellow with black lettering
Maximum diameter .....	2½ in.
Length .....	3¾ in. without fins
Total weight .....	2 lb
Filler .....	RDX

*o. U. S. Butterfly Bomb.* These devices (fig. 2-29) may be found in areas formerly held by enemy forces, where they were dropped by friendly aircraft. The bombs are equipped with various kinds of fuzes. They may be fuzed to detonate as they near the surface of the ground, on impact, or with a time delay. Some are fuzed to detonate after impact when touched or bumped. Even vibrations in the ground caused by a person walking nearby may cause them to explode. **LEAVE THESE BOMBS ALONE. DO NOT TOUCH THEM.** Only Explosive Ordnance Disposal units may remove or dispose of these bombs.

## CHARACTERISTICS

Color .....	OD with yellow markings
Maximum diameter .....	About 2½ in.
Length .....	About 3 in.
Total weight .....	4 lb
Filler .....	TNT

*p. Improvised Claymore (Fragmentation).* The Viet Cong locally manufacture a fragmentation mine (fig. 2-30) similar in effect to the U. S. M18A1 claymore. Major components consist of a suitable container, shaped plastic explosive,

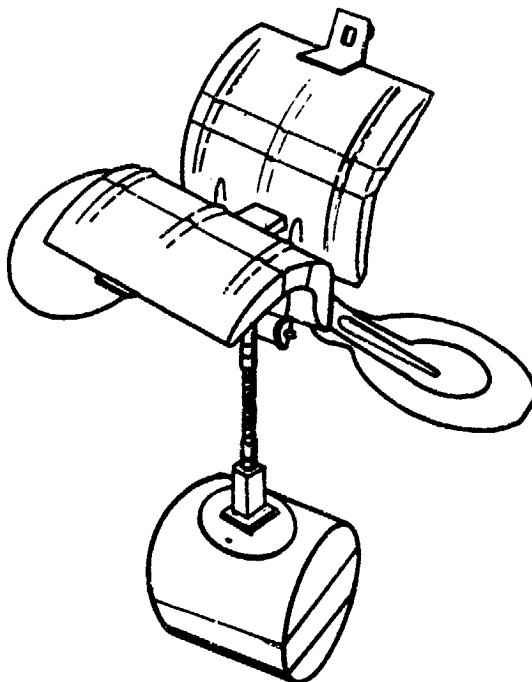

Figure 2-29. U. S. butterfly bomb.

shrapnel fragments, and an electric detonator. Typical package size is approximately 4 inches by 6 inches by 18 inches. The plastic explosive is formed in the box into a concave shape to produce a fan dispersion effect for the projectiles. Projectiles are obtained by filling the concave portion with nuts, bolts, nails, glass, machinegun links, and other shrapnel-producing material. When fired, the mine produces a fan shaped casualty area. The mine is highly effective up to 50 meters. The mine is usually employed in pairs. The Viet Cong use this type of mine in indoor gathering places as well as outdoors.

*q. Skyhorse.* This is an improvised antipersonnel weapon (fig. 2-31) made from a pipe approximately 2 inches in diameter and 1 to 3 feet long. The pipe is closed at one end. An explosive charge is placed in the barrel followed by an assortment of articles such as rocks, nails, bolts, barbed wire, and other shrapnel-producing material. The barrel is then sealed with wax. It has a simple mousetrap actuator on the exterior which may be fired with a lanyard or tripwire. This weapon is typically emplaced to cover roads, trails, or avenues on which troops may approach. It is rigged so it can be detonated by a Viet Cong

by pulling a lanyard, or more commonly, with a tripwire so the victim actuates it himself.

r. *Shotgun Shell Antipersonnel Mine.* This mine (fig. 2-32) employs two shotgun shells mounted through two parallel boards so as to fire upward when the top board is stepped on. The design is both simple and effective.

s. *Viet Cong Pipe Mine.* The Viet Cong pipe mine (fig. 2-33) is employed against small boats and personnel. The mine is placed by fitting the open end of the pipe mine over a bamboo stake driven into the ground. Pressure on the split firing rod drives a primer onto a nail (firing pin), detonating the confined black powder charge. The resulting explosion forces the wax plug and shrapnel

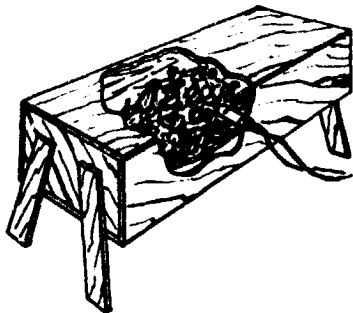

Figure 2-30. Improvised claymore (fragmentation).

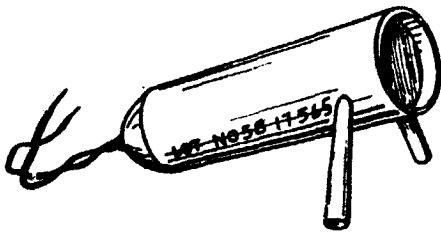

Figure 2-31. "Skyhorse" Viet Cong mine.

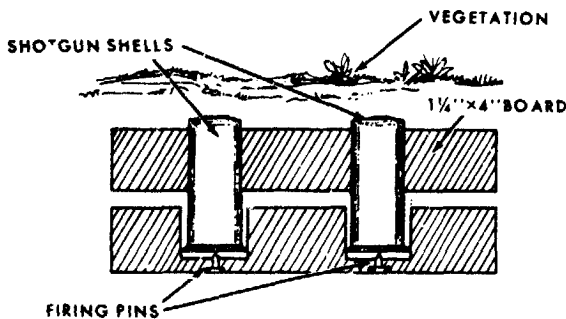

Figure 2-32. Shotgun shell antipersonnel mine.

CUTAWAY VIEW

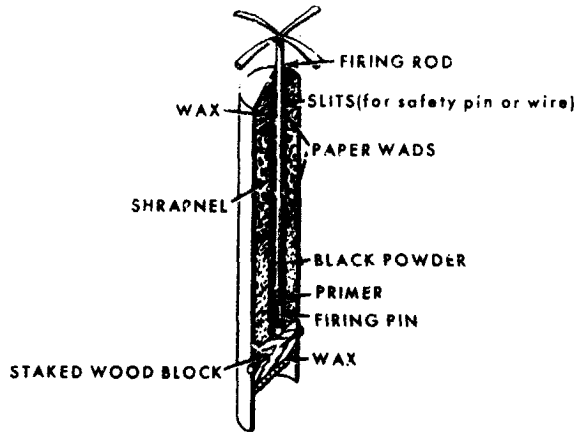

Figure 2-33. Viet Cong pipe mine. (Not drawn to scale)

out of the tube. Approximately 20 pounds pressure is required to detonate this mine, normally called a shotgun mine.

CHARACTERISTICS

Color .....	Galvanized pipe
Diameter .....	2 in.
Length .....	14 to 16 in.
Explosive charge .....	Black powder
Weight of explosive .....	1/2 lb
Total weight .....	6 to 8 lb
Activating force .....	20 lb

t. *Soviet PMN Antipersonnel Mine.* The PMN (fig. 2-34) is a delay armed pressure fired mine designed for use against personnel. The mine case is a cylindrical casting of brown plastic similar to Bakelite in appearance. The two adaptor plugs (initiator and firing assembly) are threaded to opposed holes in the case. The underside of the case is reinforced with four equally spaced radial ribs. The pressure plate is a plastic disk which is bonded to the underside of a molded sheet rubber cover. The edge of the cover is secured to the upper portion of the mine case by a circumferential metal band. The mine is safed by a pin, and when it is withdrawn, the firing pin moves forward under pressure of the firing pin spring until a wire in the after end of the firing pin spindle contacts a lead strip in the arming delay assembly. After a delay of 15 to 20 minutes the wire severs the lead strip, releasing the firing pin which moves forward until it is halted by a step in the cylinder cavity. When pressure is applied to the pressure plate, the step is forced downward, releasing the firing pin which fires the initiator. Total weight of the PMN is 1.32 pounds.

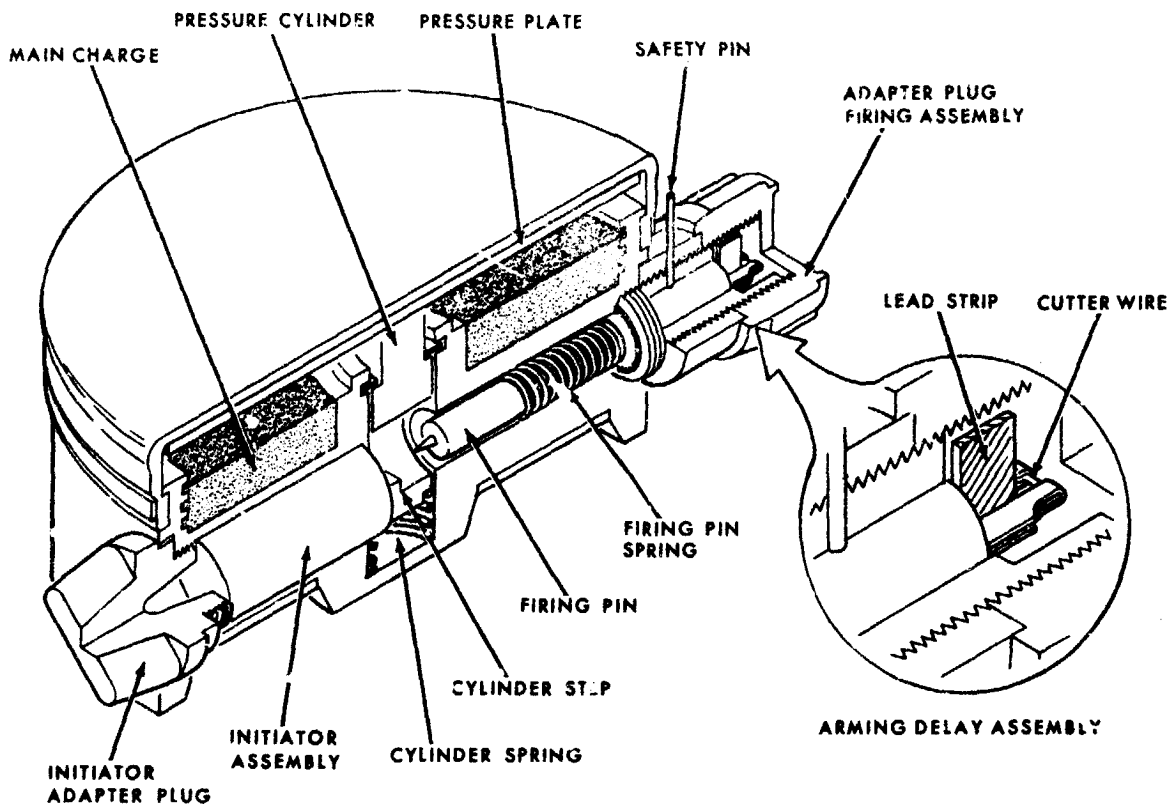

Figure 2-34. Soviet PMN antipersonnel mine.

**CHARACTERISTICS**

Color .....	Black
Shape .....	Circular
Diameter .....	4½ in.
Height .....	2¼ in.
Weight .....	2 lb (approx.)

*u. Bounding Bazomine Shaped Charge Mine.*  
 This Viet Cong shaped charge mine (fig. 2-35) is employed as an antitank or antivehicular mine. The mine is constructed of steel pipe riveted to a metal base. The mine has the safety pin removed before the main shaped charge section is placed into the base. An electric cap detonates the propelling charge in the base and fires the mine upward. When the mine hits something, the impact firing pin strikes the primer exploding the main charge.

**CHARACTERISTICS**

Weight .....	4.4 lb
Diameter of mine .....	5.5 in.
Height .....	9.8 in.
Diameter of body .....	6.7 in.
Height of body .....	11.8 in.
Body .....	Steel
Cap for mine .....	Cast iron
Bursting charge .....	Composition of melinite

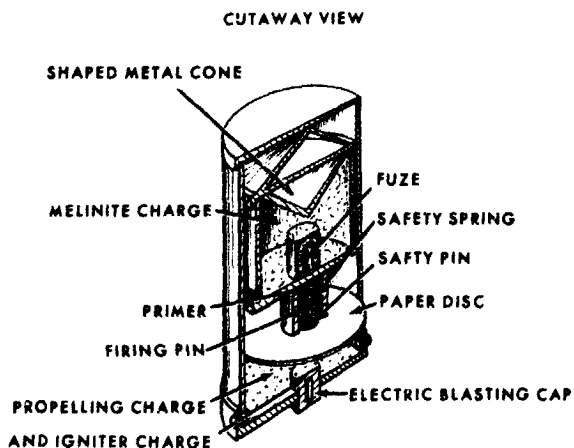

Figure 2-35. Bounding bazomine shaped charge mine.

*v. Viet Cong FT 40 Mine.* The Viet Cong use the FT 40 mine (fig. 2-36) as a road mine and as a demolition charge. It is made of riveted steel sheets. It uses a dual, two electrical cap firing system which is command detonated. The charge is approximately 83 pounds of melinite.



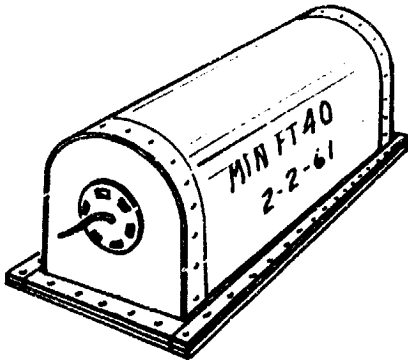

Figure 2-36. Viet Cong FT 40 mine.

**CHARACTERISTICS**

Color .....	Black
Weight .....	121.25 lb
Explosive .....	Melinite
Fuze .....	Electric caps (2 ea)
Body .....	Sheet steel

**2-3. Demolition Charges.** The Viet Cong employ numerous demolition charges as antipersonnel or antivehicular mines and boobytraps. As with mines, most demolition charges are locally fabricated and make use of a variety of explosives. The type of fuze employed will vary with the initiating action desired and the availability of fuzes and/or firing devices.

*a. Viet Cong Cone Mine.* The Viet Cong cone mine (fig. 2-37) is rudimentally fabricated of riveted sheet metal. The 9 pound TNT charge is detonated by two pressure pull igniting devices both utilizing a 9 second delay. This delay allows a Viet Cong saboteur to leave the immediate vicinity before the explosion. The igniting device is locally made. It consists of two parallel detonator trains with separate pressure-pull strings, igniting devices, igniter charges, and detonators. The detonator train is inclosed in an oil can and held in the charge hole in top of the mine by five screws. This double system increases the reliability of an improvised weapon. The mine has a carrying handle and two supports which position the mine for firing.

**CHARACTERISTICS**

Color .....	Usually black
Overall length .....	8 in.
Largest diameter .....	9 in.
Smallest diameter .....	5 in.
Handle length .....	4 in.
Total weight .....	15 lb
Explosive filler .....	TNT or improvised explosive

**CHARACTERISTICS (Continued)**

Filler weight .....	9 lb
Diameter fuze well .....	2 in.
Support length .....	1 in.

*b. Large Shaped Charge Mine.* This shaped charge (fig. 2-38) is encased in heavy-gage sheet metal with welded seams. Its fuze is a pull-release or pull-friction device or various types, which is initiated by a nearby Viet Cong. Occasionally this charge is found fuzed for electrical initiation.

**CHARACTERISTICS**

Color .....	Unpainted or black
Maximum diameter .....	9 in.
Minimum diameter .....	5 in.
Height .....	11 in.
Total weight .....	22 lb
Explosive filler .....	TNT
Filler weight .....	13.5 lb

*c. Viet Cong Small Shaped Charge Mine.* This mine (fig. 2-39) is typical of the smaller shaped

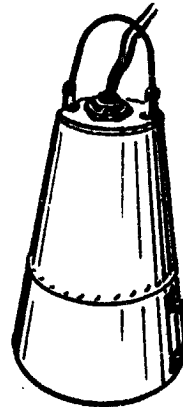

Figure 2-37. Viet Cong cone mine.

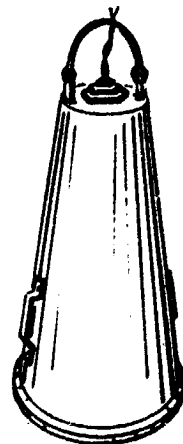

Figure 2-38. Large shaped charge mine.

charge units locally constructed by the Viet Cong. It is constructed of black sheet metal fastened together by rivets. The example mine contains 11 pounds of melinite explosive in a shaped charge configuration. There is a handle attached for rapid carrying and positioning of the mine. The mine is electrically fired. The 5 kg shaped charge more normally has the appearance of a smaller version of the 10 kg large shaped charge.

#### CHARACTERISTICS

Color .....	Black
Large diameter .....	9 in.
Small diameter .....	6 in.
Length .....	8½ in.
Weight .....	17½ lb
Explosive filler .....	Melinite (picric acid)
Filler weight .....	11 lb
Markings .....	Fuze well red. 2 figure 9's opposite one another on the mine body.

*d. Turtle Charge.* The turtle charge (fig. 2-40), or sheet metal turtle mine, is encased in separate pieces of sheet metal riveted together and coated with a black waterproofing compound. This charge can be initiated either electrically or mechanically (with or without a delay element). Either type of fuze would be located in the fuze well on the side of the charge and would be initiated by a nearby Viet Cong.

#### CHARACTERISTICS

Color .....	Black
Length .....	4 in.
Width .....	9 in.
Height .....	5 to 6 in.
Total weight .....	20 lb
Filler .....	Picric acid (melinite) or TNT
Filler weight .....	7½ lb

*e. Volume Mine, Cylindrical.* The cylindrical volume mine is normally encased in sheet metal as illustrated in figure 2-41. It has been made from artillery and mortar projectile shipping con-

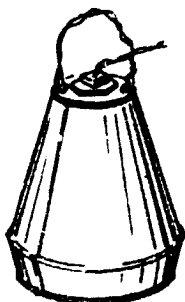

Figure 2-39. Viet Cong small shaped charge mine.

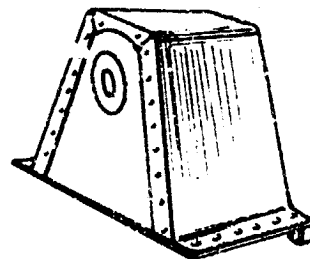

Figure 2-40. Turtle charge.

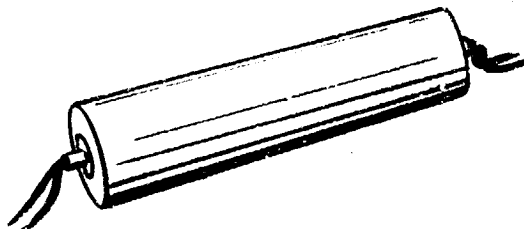

Figure 2-41. Typical volume mine, cylindrical.

tainers, and large diameter pipe such as POL pipe. Hollow bamboo sections are also used for improvised, camouflaged explosive containers. Dimensions and weight vary considerably although total weight ranges from 5 to 25 pounds. The explosive filler is TNT, potassium chlorate, or an improvised explosive. The charge is normally fired electrically by a nearby Viet Cong using batteries or a hand-held generator. However, it may also be fired by pull-friction, mechanical, or delay firing devices. It will possibly have a detonator in each end of the mine to enhance the system reliability. A volume mine weighing 95 pounds has been found, and so it is difficult to give an exact weight range for these munitions.

*f. Pole Charge.* The pole charge (fig. 2-42) consists of a quantity of explosive wrapped in a waterproof material and lashed to a 3- to 4-foot pole. The waterproof covering material is usually tarpaulin or canvas. The explosive, normally potassium chlorate, is initiated by a piece of time fuze crimped to a nonelectric detonator in the explosive. Total weight of the charge varies from 8 to 18 pounds. Pole charges are generally used during assaults to destroy barbed wire and bunkers. The construction is adapted in most cases to the anticipated application.

*g. Oil Drum Charge.* The oil drum charge (fig. 2-43) is made by partially filling a standard U. S. 5-gallon oil or lubricant drum with explosive and installing a wristwatch firing device (para 3-2d)

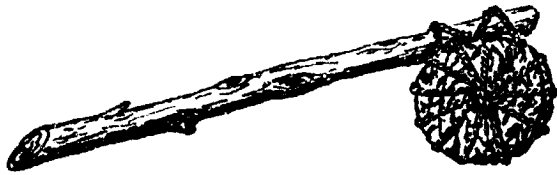

Figure 2-42. Typical pole charge.

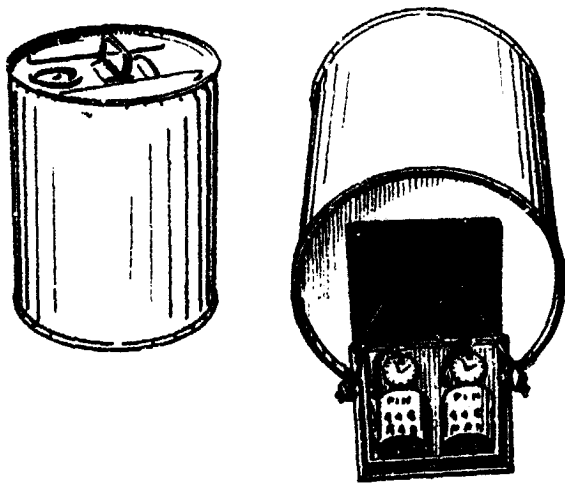

Figure 2-43. Oil drum charge.

in the bottom end. The example illustrated in figure 2-43 has two firing devices to insure that the charge will explode even if one device malfunctions. The sabotage applications of this type of demolition are obvious.

*h. Bangalore Torpedo.* The bangalore torpedo is generally made from a length of 2-inch diameter pipe filled with TNT or picric acid. The specimen illustrated in figure 2-44, one of the better made items, has a fuze well in one end. The most commonly encountered bangalore torpedoes are much cruder in appearance. They may be found with any type of fuze. There is an increasing use of the bangalore torpedo by the enemy.

*i. Chinese Communist TNT Demolition Block.* The Chinese Communist TNT demolition block (fig. 2-45) is rectangular in shape with a detonator well in one end of the block. The detonator well is marked by a black dot on the yellow waxed paper wrapping which covers the block. The block comes in 200 and 400 gram sizes (.44 or .88 pound). The TNT block can be fired by any standard or improvised firing device. This explosive is widely used by the Viet Cong.



Figure 2-44. Typical bangalore torpedo.

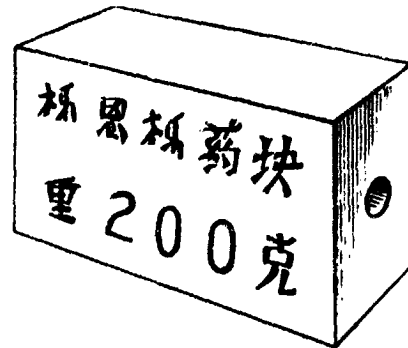

Figure 2-45. Chinese Communist TNT demolition block.

*j. Soviet TNT Demolition Block.* The Soviet TNT demolition block (fig. 2-46) is rectangular in shape, measuring 2 by 2 by 4 inches in size. It has a detonator well in one end of the block. The block is covered with wax paper on which is written in Russian a description of the block's contents. This .96-pound block is used as a booster block in much of the Viet Cong's demolition work. The block can be fired by any of the standard or improvised firing devices.

*k. Viet Cong Satchel Charge.* A Viet Cong locally produced satchel charge (fig. 2-47) is made of explosives bound by waterproof cloth, rope, wire, bamboo strips, or other available material. The detonator of a stick grenade is used to ignite the 5 to 10 pounds of explosive commonly used in the satchel charge. Extreme caution must be exercised when handling these charges because potas-

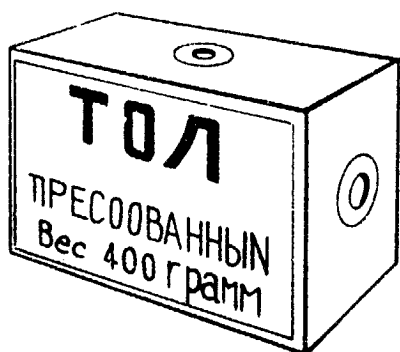

Figure 2-46. Soviet TNT demolition block.

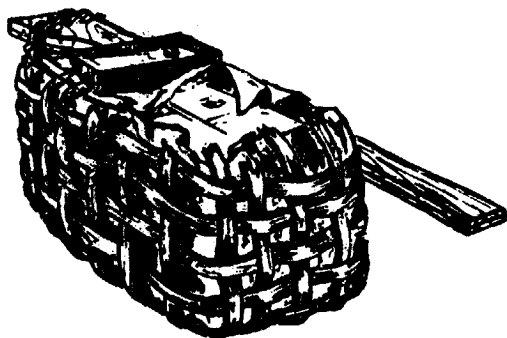

Figure 2-47. Typical locally produced Viet Cong satchel charge.

sium chlorate, a sensitive explosive, may be used in them. Enemy sappers also have recently used charge assemblies of foreign origin, probably Chinese Communist, the explosive weight of which exceeds thirty pounds. The satchel charge is used for all Viet Cong demolition work, especially destroying bunkers and fortifications during assaults. The typical Chicom satchel charge is very similar in appearance to the U. S. M37 demolition charge assembly. The firing device is one fuze lighter, time delay fuze, and a nonelectric cap on top of the charge, but under the canvas.

**2-4. Water Mines.** The Viet Cong have used water mines with a large measure of success. Although they are often locally fabricated, they are very effective. In addition to the water mines listed, other crudely fabricated explosive charges have been employed as water mines. Most water mines appear to have one thing in common; the detonation is usually initiated electrically. This method requires electrical wires running to the shore where a concealed man detonates the mine by bat-

tery or generator. Viet Cong are known to run the command detonation line upstream for approximately 1 kilometer before bringing it in to the bank. This Viet Cong technique can be countered by moving the minesweeper, with appropriate security, approximately 1 kilometer ahead of the escorted vessels. Mines and explosives may be tied to tree trunks or placed in boats in midstream. When a target passes by, the mine is exploded. Command detonated mines have been placed in the bottom of shallow waterways less than 1 meter in depth. In deep channels, mines may be placed at varying depths to engage different vessels. Mines may be lowered to allow vessels to pass and then raised in the path of a target vessel. The mines also may be moved back and forth in the path of a vessel. The Viet Cong seek to place water mines where vessels must slow down, bunch up, or stop.

*a. Bevelled Top Water Mine.* Bevelled top water mines (fig. 2-48) are found in large quantities in the Mekong River and its tributaries. They are placed at depths compatible with the draft of the boats plying the particular waterway. The mine is constructed of sheet metal rolled into a conical shape and fastened with soldered or riveted seams. A flotation chamber occupies the top or large end of the mine. An explosive filler of TNT occupies the opposite or fuze end of the mine. The mine is detonated electrically. This mine is constructed in different sizes as required for each particular application.

#### CHARACTERISTICS

Color	Black
Maximum diameter	11 in.
Height	12 in.
Total weight	27 lb
Filler	TNT

*b. Large Viet Cong Water Mine.* This water mine (fig. 2-49) is manufactured from medium gage sheet metal formed into two sections which are then riveted together. The smaller section is the TNT filled explosive section with electric fuze. The large section is the flotation section. Total weight of the mine is 83 pounds, much larger than the bevelled top mine. The mine is positioned by means of ropes handled by the Viet Cong on shore. Once positioned the mine is detonated by using a battery or hand generator. The explosive may be in a shaped charge configuration.

#### CHARACTERISTICS

Color	Black
Shape	Conical
Maximum diameter	17 in.
Height	25 in.

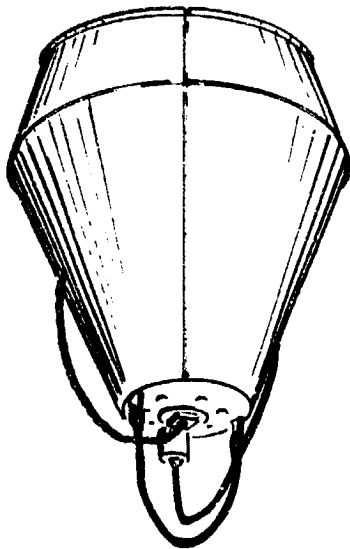

Figure 2-48. Bevelled top water mine.

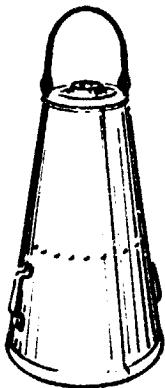

Figure 2-49. Large Viet Cong water mine.

CHARACTERISTICS (Continued)

Total weight .....	83 lb
Filler .....	TNT
Filler weight .....	41 lb

c. *Magnetic-Acoustic Mine.* This mine is cylindrical in shape and constructed in three main sections. The first two sections contain the explosive charge. The third houses the firing mechanism—a Soviet magnetic-acoustic control mechanism with modifications. Additional explosive sections may be utilized. The mine has negative buoyancy and would normally be employed as a bottom mine. It is given positive buoyancy by use of a flotation bladder, to permit placement in the channel. The bladder is then deflated, allowing the mine to sink to the bottom. When a ship approaches the mine, the noise generated by the ship

activates the acoustic mechanism of the mine. The activation is termed an acoustic look. As the ship comes closer, the magnetic lines of force concentrated by the vessel disturb a search coil magnetic field. This interaction of magnetic fields generates an electric current which is fed through the mine's firing circuits causing detonation. The mine requires one acoustic look and one magnetic look to fire. The use of a ship counter mechanism permits the mine to be preset to allow from one to 20 contacts to pass overhead without firing. No illustration available.

CHARACTERISTICS

Length .....	74 in.
Diameter (including flanges) .....	17.5 in.
Weight .....	850 lb
Explosive weight .....	485 lb

d. *Limpet Mine.* This mine has a semicylindrical case made from molded bakelite. The interior of the mine is divided into a center compartment for the main charge and two end compartments containing horseshoe magnets. The mine's underside is a flat rectangular surface. A canvas strap is attached to one end and a machined anodized aluminum initiator is threaded into the other end. The mine is magnetically attached to a ship's hull by a swimmer. The initiator operates on a material density principle. When the safety ring is pulled, the firing pin spring forces the firing pin toward the detonator. The firing pin is prevented from striking the detonator by a tungsten wire which passes through a soft metal delay tab. Depending on the thickness of this tab and the ambient temperature, the wire takes a predetermined time to cut the tab. The firing pin, no longer restrained, is driven into the detonator, exploding the mine. The sapper is guided in his choice of tabs by six color codes which are correlated to a chart that tabulates delay times available based on the ambient temperature of the water where the mine will be used. Depending on the tab selected and the water temperature, delays from a minimum of 5 minutes to a maximum of 832 hours are possible.

CHARACTERISTICS

Length .....	10 in.
Width .....	4.5 in.
Weight w/booster .....	10 lb
Weight w/o booster .....	6.5 lb
Explosive: Main charge .....	Cast tritonal
Booster .....	RDX
Explosive weight, main charge .....	2.5 lb

e. *Soviet BPM-2 Limpet Mine.* This sophisticated mine (fig. 2-50) is a half sphere in shape.

Attached to a metal surface by four arcs of 11 small horseshoe magnets on its flat side, it is activated by one of two metal fatigue, time delay fuzes. The delay varies with the ambient water temperature and the thickness of the metal (lead) tabs. Delays from 5 minutes to 832 hours may be selected. The delay mechanism is a steel wire cutting through a lead strip. The mine has a delayed arming, anti-removal, firing device which also arms on the metal fatigue principle. Short delays of 5 to 30 minutes would normally be used in this device. The anti-removal fuze is located in the center of the flat side of the mine. The mine may be surrounded by bulk explosive with up to an additional 80 kg having been used. It is extremely effective against light shipping even without the supplemental charge. This mine should not be disturbed if attached to a metal object. Only expert EOD personnel should attempt to disarm the mine.

#### CHARACTERISTICS

Color .....	Haze grey
Shape .....	Half sphere
Diameter .....	10 in.
Thickness .....	4.5 in.
Weight .....	14 lb 10 oz
Explosive weight .....	6 lb 10 oz
Case material .....	Aluminum

*f. Floating Contact Mine.* This mine is approximately the size of a 5-gallon bucket. It is constructed of standard roofing weight galvanized iron with soldered seams. The mine is closed at the top by means of a conical cover. Two flashlight size cylinders or horns protrude from opposite sides of the top. These horns are divided into two sections held together by a rubber covering made from inner tubing to provide flexibility. When this horn assembly is struck, the electrical circuit of the mine is closed, causing two electrical detonators set in two of the four 75-mm U. S. projectiles used as the explosive to detonate. The explosion of the first two projectiles sympathetically detonates the remaining two. The explosive content of each mine is estimated at 5 to 6 pounds. These free

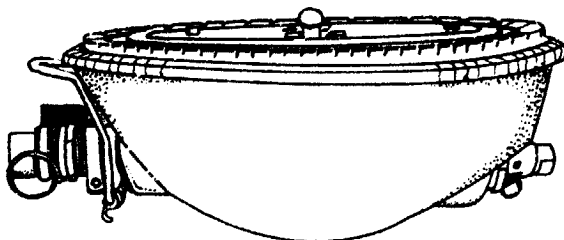

Figure 2-50. Soviet BPM-2 Limpet mine.

floating contact mines are employed in attached pairs which have a combined explosive content rated at 10 to 15 pounds.

#### CHARACTERISTICS

Height .....	13 in.
Maximum diameter .....	14 in.
Minimum diameter .....	11 in.
Weight .....	60 lb
Explosive .....	4 ea 75-mm U. S. projectiles
Firing system .....	Electrical contact actuated

*g. Bouyant Shaped Box Mine.* This mine is trapezoidal in shape and constructed of thin galvanized sheet metal with riveted and soldered joints. A triangular flotation chamber made of similar material is attached to the top of the mine. Attached to three sides of the mine, by means of wire and wooden strips, are three sheet metal cylindrical flotation chambers (4 inches in diameter and 18 inches in length). The angle of the shaped charge cavity is approximately 90 degrees. This shaped charge cavity contains 430 pounds of cast TNT. The booster consists of 10 pounds of granulated TNT primed with two electric blasting caps wired in series. Interspersed in the booster are some 20 nonelectric blasting caps with 2-inch leads of detonating cord. This mine is designed for command detonation.

#### CHARACTERISTICS

Base .....	21 x 37.5 in.
Top .....	12 x 37.5 in.
Sides .....	21 x 37.5 in.
Weight .....	470 lb
Explosive .....	Cast TNT
Explosive weight .....	430 lb

*h. Pressure Influence Mine.* The presence of a pressure influence mine detonating device indicates that the Viet Cong have a pressure influence mine. This device is designed to be activated by the pressure wave generated by vessels underway in shallow water. The device is armed by immersion in water as a water soluble washer deteriorates and releases a spring controlled mechanism. It is designed to adjust to gradual changes in water pressure such as tides or currents. The device has the external appearance of a closed metal cylinder with a rubber pressure bulb or balloon on one end. The pressure bulb is enclosed in an open metal protective cage. The metal cylinder is divided into two sections. One section is sensitive to water pressure by means of the rubber balloon. The other is a control section. A rubber bellows between sections expands to close a detonation circuit when the water pressure wave alters the air pressure balance between the two

sections. The device is probably employed with a bottom mine.

i. *Soviet MKB Chemical Horn Contact Mine.* This water mine (fig. 2-51) is in the shape of an elongated sphere. It weighs 984 pounds including a 566 pound main charge of TNT. When subjected to pressure, a large hydrostatic arming switch closes two breaks in the firing circuit and removes a shunt from the chemical horn circuit. Then vertical orientation of the mine case permits a mercury switch to close the firing circuit. There are five chemical horns. The mine is usually moored by an anchor which in one case, weighed 1450 pounds. It is usually launched by surface ships.

**CHARACTERISTICS**

Diameter	-----	34.5 in.
Explosive: Type	-----	TNT
Weight	-----	566 lb
Booster	-----	Tetryl
Case material	-----	Steel

j. *Spherical Floating Moored Mine.* The Viet Cong have adapted the welded metal case originally made for use as a mooring buoy to use as a water mine. Any bulk explosive is used as a charge with the charge weight totaling 125 pounds. The detonating system is electrical. The case diameter is 22 inches (fig. 2-52). This mine may also be equipped with electric contact horns.

k. *Twin Can Floating Mine.* Two rectangular 5 gallon cans containing explosives are secured in

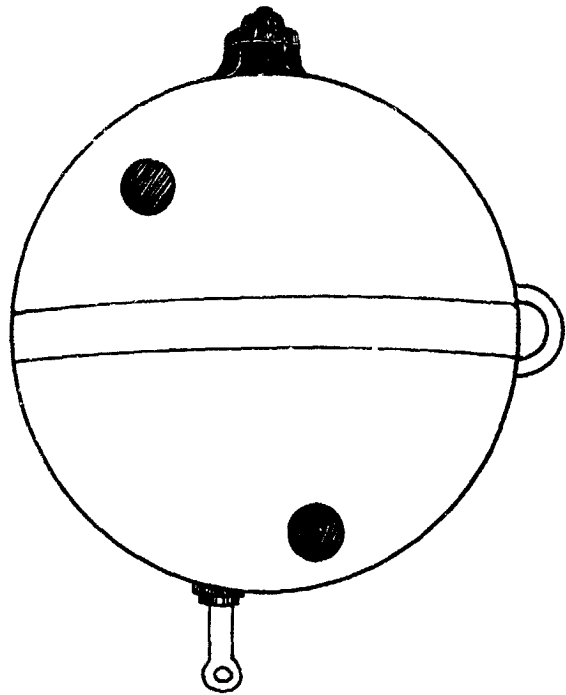

Figure 2-52. Spherical floating moored mine.

line between two wooden poles (fig. 2-53). For buoyancy, each can is equipped with an inflated rubber air bladder and two pieces of palm log about 20 inches long. Two short sticks inserted between the main poles are utilized to attach and support a double timing device and a battery power pack. The timing device was two mechanical alarm clocks with contacts wired in parallel to make contact with the hour hands. This mine is typical of many such variations usually designed for a specific application.

**CHARACTERISTICS**

Length	-----	60 in. (approx)
Width	-----	15 in. (approx)
Height	-----	15 in. (approx)
Explosive: Weight	-----	187 lb
Type	-----	TNT (CHICOM)

l. *Metal Box Floating Mine.* This mine (fig. 2-54) utilizes two sheet metal rectangular boxes linked together by a single lead of detonating wire from each box joined to a third wire leading to an electric power source. Each box contains 80 pounds of U. S. C-4 plastic and 40 pounds of TNT (CHICOM). The boxes are sealed at the top with a putty like substance. A rubber air bladder provides buoyancy for each box.

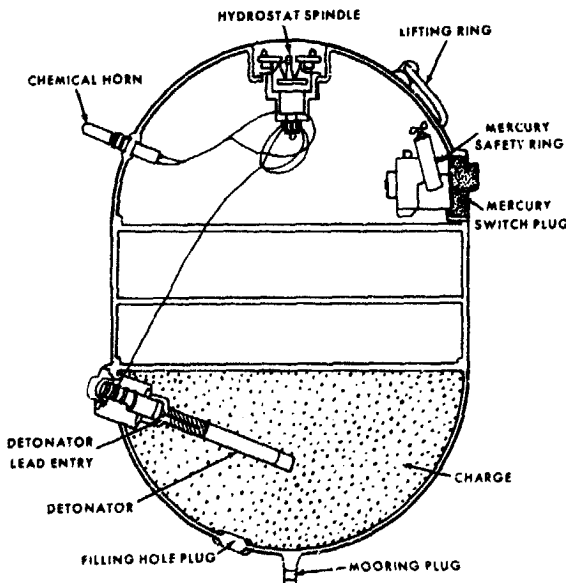

Figure 2-51. Soviet MKB chemical horn contact mine (section view).

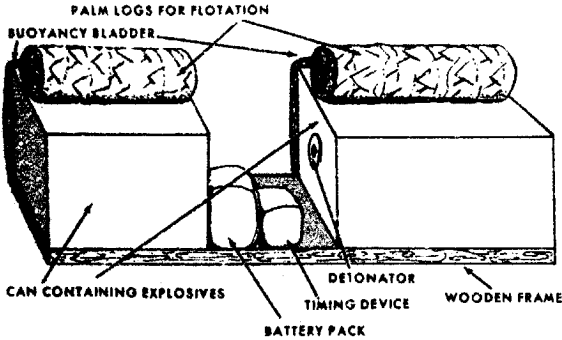

Figure 2-53. Twin can floating mine.

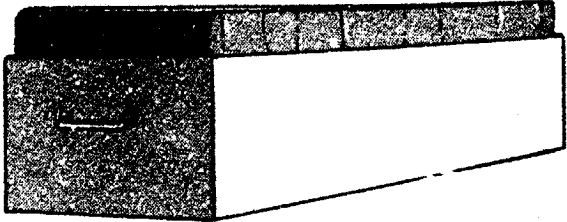

Figure 2-54. Metal box floating mine.

**CHARACTERISTICS**

Length	-----	31 in.
Width	-----	14.5 in.
Height	-----	11.5 in.
Explosive: Type 1	-----	C-4
Weight	-----	80 lb
Explosive: Type 2	-----	TNT (CHICOM)
Weight	-----	40 lb



## SECTION III

### FUZES AND FIRING DEVICES

**3-1. Fuzes.** Viet Cong forces employ a variety of fuzes ranging from standard items of foreign manufacture to simple fuzes of local manufacture. Among the standard fuzes are those which are integral components of mines previously discussed in section II of this circular. Others include Soviet pressure and pull fuzes which can be adapted to a number of explosive devices, and U. S. fuzes which may fall into the hands of the Viet Cong. Integral mine fuzes and U. S. fuzes are not discussed in detail in this circular. The Viet Cong make extensive use of instantaneous fuzes and will render delay fuzes, such as those in hand grenades, instantaneous by removing the delay elements. In these instances, the Viet Cong often mark the device in red for identification, and U. S. troops should be cautioned against tampering with such items. The fuzes in this section are those either widely used by the Viet Cong or known to be readily available to them.

*a. Pull-friction Fuze.* The pull-friction fuze (fig. 3-1) is probably the fuze most widely used by the Viet Cong. Simple in design, the fuze can be manufactured locally with readily available, inexpensive materials. As a consequence, it can be produced in quantities sufficient to employ it in a variety of mines, boobytraps, and explosive devices. The fuze consists of a fuze body, detonator (nonelectric blasting cap), copper bell, copper pull wire, match compound, and pull cord. A pull of 5 to 6 pounds on a trip wire attached to the pull cord activates the fuze. A pull of 2½ inches on the pull cord, which is attached to the coiled copper pull wire, uncoils the copper pull wire forcing it through the phosphorous match compound inside the copper bell. This action ignites the match compound which then activates the detonator and main charge in turn. Although designed to be an instantaneous fuze, delays accompanied by sparks and smoke have been common. The delay is caused by imperfections in manufacture and/or an accumulation of moisture in the match compound, and may result in variations and delays longer than 5 seconds.

#### CHARACTERISTICS

Type .....	Pull-friction
Diameter .....	Fuze body—approx ¾ in. Detonator—approx ¼ in.
Length .....	Overall—approx 2½ in. Fuze body—approx ¾ in. Detonator—approx 1½ in.
Safeties .....	None
Delay .....	0 to 6 seconds

*b. Chemical Fuze.* The chemical fuze (fig. 3-2) is used for sabotage. It can be attached to any mine or demolition charge. The fuze is initiated by breaking the corrosive liquid vial; the corrosive solution then gradually corrodes the wire which restrains the firing pin. When the wire has weakened sufficiently; the firing pin is released and strikes the primer, detonating the charge. The delay time provided by this fuze varies with temperature and wire diameter.

#### CHARACTERISTICS

Type .....	Delay
Diameter .....	0.5 in.
Length .....	5 in.
Delay .....	20 to 38 min
Safeties .....	None

*c. Soviet Pressure Fuze MV-5.* The MV-5 pressure fuze (fig. 3-3) is used in the Soviet TM-41, TMN-46, and TMB-2 antitank mines; however, it is also used in many improvised mines where pressure initiation is desired. A pressure of 26 pounds or more on the pressure cap forces it down, compressing the striker spring and releasing the retaining ball, which escapes into the bulge. Thus freed, the spring-driven striker hits the percussion cap which in turn sets off the detonator and explodes the mine.

#### CHARACTERISTICS

Type .....	Pressure
Case .....	Metal or plastic
Diameter .....	Approx ½ in.
Length .....	Approx 1½ in.
Operating pressure .....	26 lb or more
Safeties .....	None

*d. Soviet Pull Fuze MUV.* The MUV fuze (fig. 3-4) is the most commonly used Soviet pull fuze.

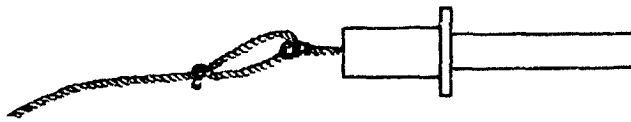

FUZE INTACT

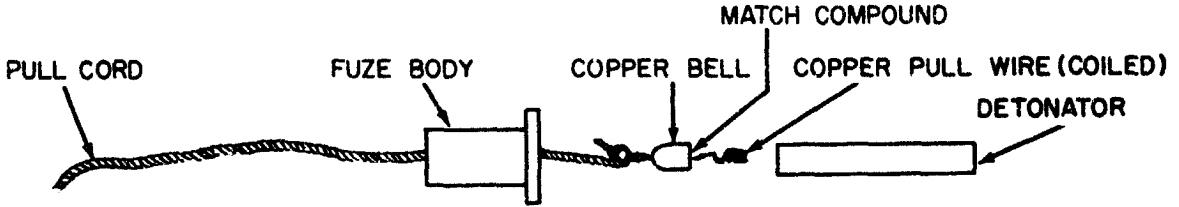

FUZE COMPONENTS



COPPER PULL WIRE UNCOILED AFTER BEING PULLED THROUGH MATCH COMPOUND IN COPPER BELL

(DETONATOR SHOULD HAVE FIRED AT THIS TIME)

FUZE BODY AND COPPER PULL WIRE

*Figure 3-1. Pull-friction fuze.*

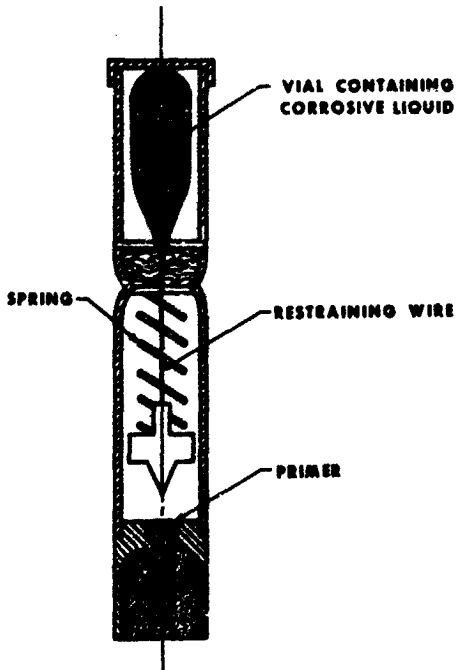

*Figure 3-2. Chemical fuze.*

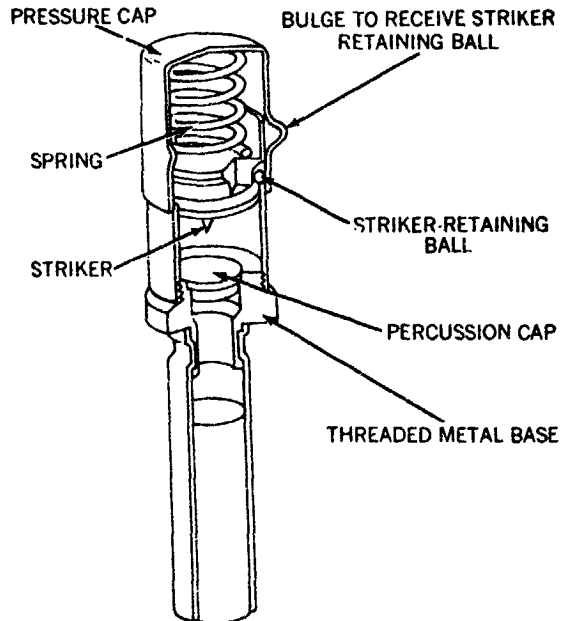

*Figure 3-3. Soviet pressure fuze MV-6.*

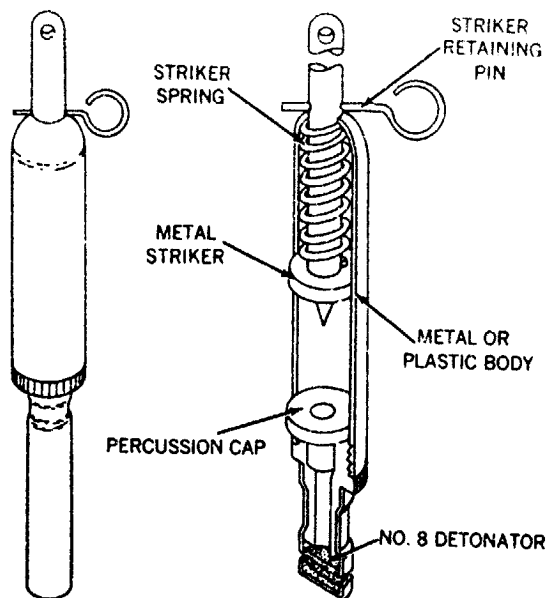

Figure 3-4. Soviet pull fuze MUV.

It is adaptable to antipersonnel mines, boobytraps, and almost any demolition charge in which a pull fuze is desired. A force of 2 pounds or more on the tripwire removes the retaining pin from the striker, which powered by the spring, strikes the detonator. This fuze also may be set for tension release actuation in which the striker is held in cocked position by a tripwire. Troops should be cautioned against cutting taut tripwires.

#### CHARACTERISTICS

Type .....	Pull
Case .....	Metal or plastic
Diameter .....	Approx ½ in.
Length .....	Approx 2¼ in.
Operating pressure .....	2 lb or more pull
Safeties .....	None except transit pin in striker

*e. Soviet Pull Fuze VPF.* The VPF pull fuze (fig. 3-5) is used widely in the Soviet army for initiating tripwire mines and boobytraps. Unlike the Soviet MV-5 and MUV fuzes, the VPF fuze has not been reported in wide use in Vietnam; however, it is readily available and may be expected to appear. The fuze functions by a pull on the pull ring, but it also may be fitted with a rod projecting from the clamp top for functioning by lateral pressure or pull. Lateral force or axial pull on the clamptop pulls the claw-like base from the ball shaped end of the striker. Released, the

striker fires the percussion cap, detonator, and main charge.

#### CHARACTERISTICS

Type .....	Pull
Case .....	Metal
Diameter .....	Approx ¾ in.
Length .....	Approx 3 in.
Operating force .....	2.5 to 3.5 lb lateral pull; 8 to 14 lb axial pull
Safeties .....	Safety pin through striker

*f. Chinese Communist Pressure/Pull Fuze.* The Chinese Communist pressure/pull fuze (fig. 3-6) has a cylindrical brass case enclosing a striker retaining pin, a striker, a striker spring, and a safety pin. After installation of the detonator and removal of the safety pin, the fuze is activated either by sufficient pressure exerted on the top to shear the striker-retaining pin or by a pull of 10 to 50 pounds on the pull ring. The amount of force required for activation can be adjusted by a threaded bolt in the top of the case. The fuze is used with the Chinese No. 4 dual purpose mine.

#### CHARACTERISTICS

Maximum diameter .....	1.75 in.
Length .....	2.62 in. w/o detonator
Case material .....	Brass
Safety device .....	Pin

**3-2. Firing Devices.** The commonly used firing devices employed by the Viet Cong are improvised. One of the most common means of detonating mines and other demolition charges is by command electrical firing systems. This requires only an electrical blasting cap, a length of firing wire, and a power source. Although there is no need for

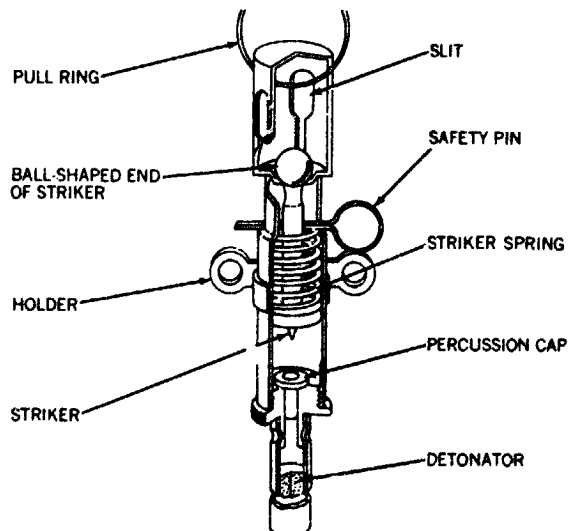

Figure 3-5. Soviet pull fuze VPF.

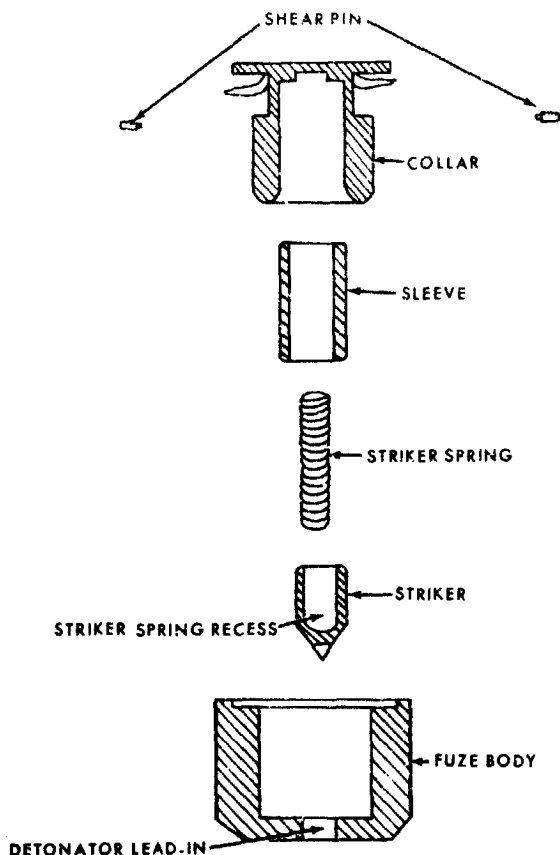

Figure 3-6. Chinese Communist pressure/pull fuze.

a technical discussion of this system, employment techniques are covered in section V. Pressure actuated electric firing systems are widely used, and the number and type are governed only by Viet Cong ingenuity. The devices in this section have been reported in general use; however, it can be seen readily that a number of innovations and variations are possible. The wristwatch and mousetrap devices are special applications.

One technique normally used by the Viet Cong is to wrap pressure or pressure electric firing devices in plastic sheeting, poncho material, canvas or rubber sheeting to aid in waterproofing and to minimize the possibility of dirt getting between the parts of the device and preventing contact. Therefore, the firing devices are customarily buried one to three inches below the road surface.

*a. Pressure-Electric Firing Devices.* Viet Cong forces are noted for simplicity in design and construction of these devices (fig. 3-7). A common example, in two variations, consists of two boards held apart by either wooden blocks or dowels.

Bare electric wires or metal contacts are fastened to the inside faces of the parallel boards. One insulated wire extends from one board to the mine, and another insulated wire extends from the second board through a power source to the mine. Where the boards are held apart by the blocks of wood, the boards may vary in length from 1 foot to the width of a road. Pressure exerted by the wheel of a vehicle or even the weight of a man will force the boards and wire contacts together, completing the electric circuit and detonating the mine. Dowels are sometimes used in place of the wooden blocks. In this application the boards are short and holes are provided in the top board which are slightly smaller in diameter than the dowels. This tends to require greater force than the weight of a man to complete the electric circuit. These devices can be placed on the surface of the road and camouflaged with rags, bamboo, leaves, etc. These firing devices are used primarily in antivehicular applications.

*b. Pressure-Electric Firing Device (Antipersonnel).* In this pressure-electric firing device (fig. 3-8), a wooden frame serves as a channel guide for a spring loaded movable pressure piece. A bolt is attached to the movable pressure piece to serve as one terminal of the circuit. One bare strand of double strand electric wire is positioned directly below the bolt on the wooden frame. The other strand is attached to the bolt. When a man steps on the device, the pressure plate moves downward so that the bolt contacts the bare wire completing the circuit and detonating the explosive charge. The operating force of the movable pressure piece varies widely with the workmanship of the device and the strength of the spring.

*c. Bamboo Pressure-Electric Firing Device.* This device (fig. 3-9) is similar in function to pressure-electric firing devices discussed pre-

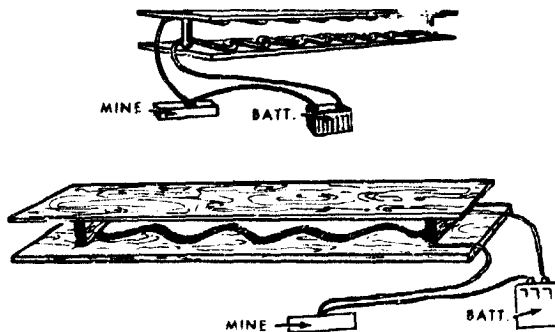

Figure 3-7. Pressure electric firing devices.

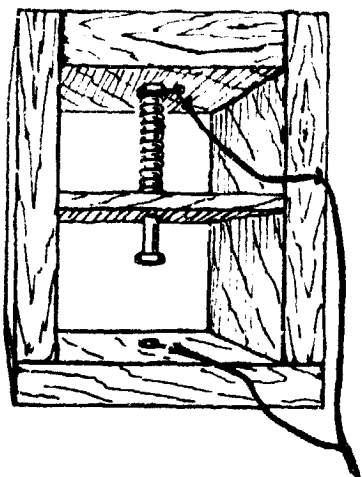

Figure 3-8. Pressure-electric firing device (antipersonnel).

viously, but its construction allows for some variation in application. The key material is a half section of bamboo which has been split along the length. A flat metal terminal (usually pieces of tin can) is nailed to the concave side of the bamboo section. Directly under this terminal, a second terminal is attached to the flat board which serves as the base of the device. The terminals are then wired to a current source and the explosive charge or mine. A vehicle running over the device crushes the bamboo, forcing contact of the metal plates. The completed circuit fires the detonator and main charge. Dry bamboo usually crushes from the force of the first vehicle to cross it. If they wish to immobilize a vehicle farther back in a convoy, green bamboo is used. The resiliency of the arch of green bamboo is sufficient to require the force of several vehicles to crush it. This device is extremely simple and effective. It is easy to make. In most cases, pressure-electric firing devices are offset from the mines by a few feet or one or more vehicle lengths.

*d. Wristwatch Firing Device.* The wristwatch firing device (fig. 3-10) is used to provide a delay between the time an explosive charge (bomb or mine) is placed and the time it explodes. The delay period can range from a few minutes to 12 hours according to how the watch is altered and set. Either the minute hand (if the desired delay is in hours) or the hour hand (if the desired delay is in minutes) is broken off. One electric lead is connected to the stem or case of the watch and the second lead is connected to a screw passing through a hole in the watch crystal. The watch

runs for a preset interval until its remaining hand touches the screw; at that time the circuit is completed and an electric detonator explodes. Figure 3-10 shows an actual installation including the power supply; the inset shows the watch only, in schematic form.

*e. Mousetrap Firing Device.* The mousetrap firing device (fig. 3-11) as its name indicates, consists of an ordinary mousetrap, arranged so that the yoke, when tripped, will drive a firing pin (nail) into a percussion primer. This firing device has been frequently used on Viet Cong improvised guns. Its future use will probably be confined to boobytrap or antipersonnel mine installations.

*f. Viet Cong Pressure/Pull Firing Device.* This simple device (fig. 3-12) is used as either a pressure or a pull firing device for grenades or boobytraps. A pressure or pull applied to the striker arm forces the striker to rotate slightly, freeing the striker from the restraining lock arm. Caution must be used when disarming to insure that the striker is not inadvertently freed and allowed to strike the percussion cap.

#### CHARACTERISTICS

Height	.....	4 in.
Width	.....	1½ in. square
Material	.....	Light gage metal

*g. Helicopter Actuated Firing Devices.* The Viet Cong have developed a series of devices which sense the heavy propeller air blast (downdraft) created by helicopters and detonate directional mines into adjacent landing zones. The propeller blast either spins a pinwheel propeller or shakes an adjacent tree to initiate a detonating system. The relatively small force created by these sensing

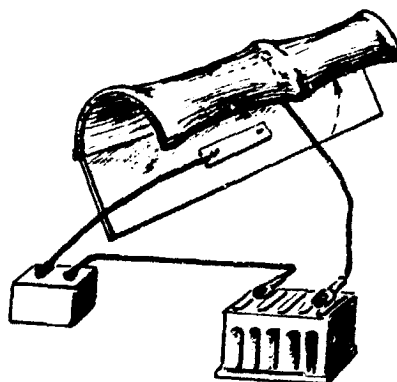

Figure 3-9. Bamboo pressure-electric firing device.

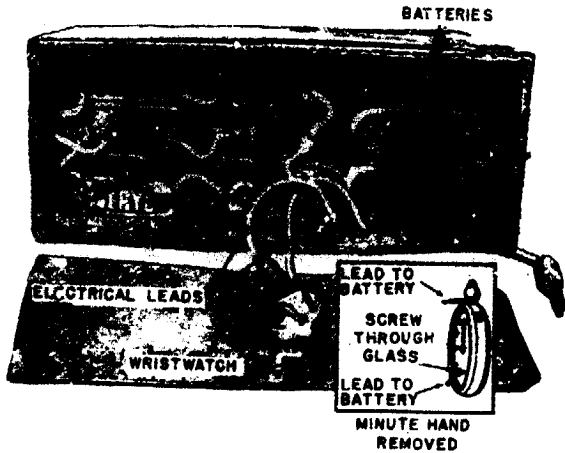

Figure 3-10. Wristwatch firing device.

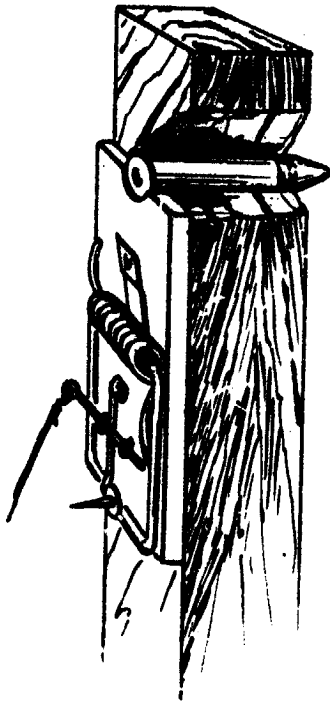

Figure 3-11. Mousetrap firing device.

devices is magnified by additional devices which release heavy weights. The "Rube Goldberg" nature of the devices does not detract from their effectiveness.

*h. Hollowed-out firing devices.* These pressure-electric firing devices, also known as "slapsticks," (fig. 3-13) are both variations of the technique of hollowing or carving out a member so that it will

bow and give under pressure. The first device uses boards which are approximately 1 inch thick at the ends and are hollowed out to approximately 3/8 inch thick at the center. The metal contacts are placed opposite one another in the hollowed out portion. The contacts are closed by pressure on the board. A second device is made from a section of bamboo approximately 1 inch in diameter. The side walls of the bamboo are carved out until two flat strips opposite one another remain. The strips are still connected and held separate by the joint at the ends. The bare wires or contacts are placed on the inside of the strips so that contact is made by pressure on the device.

*i. Bamboo Cylinder Firing Device.* In this pressure-electric firing device (fig. 3-14) a bamboo cylinder approximately 1 foot in length and 3 inches in diameter is placed vertically in the

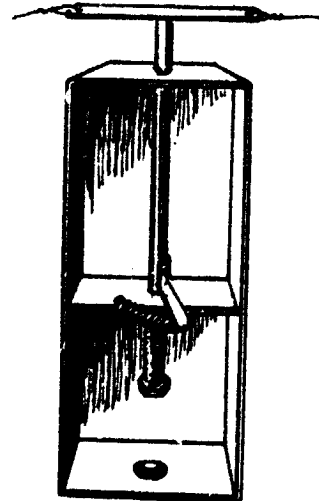
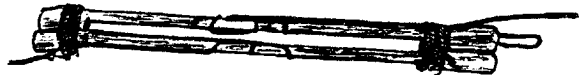

Figure 3-12. Viet Cong pressure/pull firing device.



(slapstick)



(bamboo)

Figure 3-13. Hollowed-out firing devices.

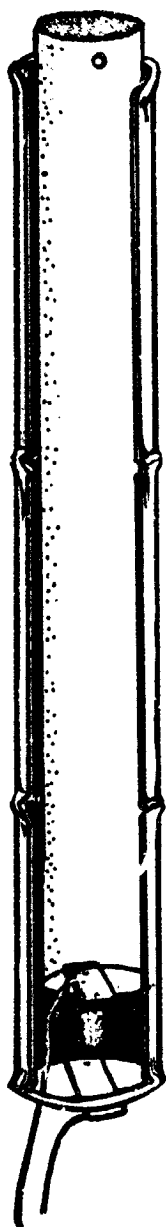

Figure 3-14. Bamboo cylinder firing device.

ground with a solid wooden shaft fitted inside the cylinder. One electric contact is a metal strip across the bottom of the cylinder while the other is a metal disk on the bottom of the wooden shaft.

Pressure on the top end of the wooden shaft closes the contacts and the circuit, firing the mine or boobytrap. Usually there is considerable friction between the two pieces of bamboo and the pressure required for closure of the circuit cannot be predicted. One vehicle driving over the device may be sufficient to cause detonation, but ten or more could be required. Since the explosive and the batteries are placed under the plunger device, detection with the P-153 mine detector is usually impossible.

*j. Chemical Delay Firing Device.* This device (fig. 3-15) consists of a metal fuze body threaded at both ends, a cap internally threaded, an acid vial, a detonator, and a blasting cap. The detonator is a metal cap filled with heat sensitive explosive and covered with delay producing paper. The cap, which contains a nail or stud, is screwed onto the fuze body breaking the acid vial. The acid dissolves the paper and comes into contact with the explosive causing a reaction and detonation. This in turn initiates the blasting cap and the main charge. When this device is employed with the BLU-3B bomb no blasting cap is used and no nail is used in the cap to break the acid vial. The acid vial is instead broken by hand and the cap screwed onto the firing device. This device has been used in satchel charges and with the BLU-3B but has obvious applications to any mine or sabotage device.

#### CHARACTERISTICS

Type	-----	Chemical delay
Shape	-----	Cylindrical
Color	-----	Brass
Markings	-----	Delay time

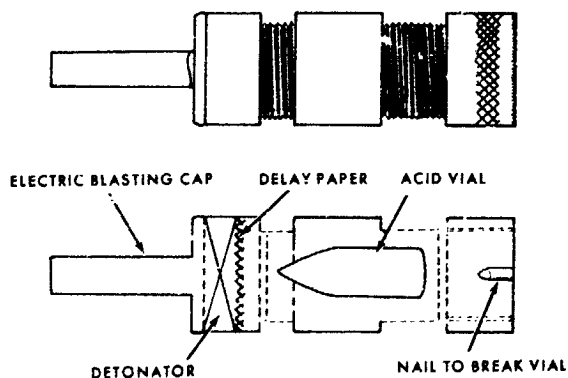

Figure 3-15. Chemical delay firing device.

## SECTION IV

### BOOBYTRAPS

**4-1. Number and Types.** The number and types of boobytraps which may be employed by the Viet Cong are almost limitless. Many explosive boobytraps have been cunningly and ingeniously employed against U. S. forces and their continued use can be expected. Included in this section are those boobytraps which have been identified as typical or common techniques of employment; however, many variations can be expected which would lengthen the list considerably. The important lesson to be learned from this circular is that the Viet Cong employ boobytraps extensively through clever improvisation with all types of materials. This section covers hand grenades (which are widely used for boobytrap purposes) explosive boobytraps and nonexplosive traps, all of which are inherent in Viet Cong tactics.

**4-2. Hand Grenades.** Although hand grenades are designed as weapons to be thrown in either an offensive or defensive role, Viet Cong forces make even wider use of them as boobytrap devices. A variety of hand grenades has been encountered as boobytraps, and their use is limited only by availability. Viet Cong manufactured hand grenades are used extensively. Both Chinese Communist and Soviet hand grenades are available for use. Captured U. S. hand grenades, particularly the M26, are used in most boobytraps suited to hand grenade adaptation. There is reason to believe that the Viet Cong prefer U.S. grenades to their own. Normal employment utilizes the grenade as it was manufactured; however, many times the Viet Cong will remove the delay element from the grenade fuze so that the boobytrap detonates instantaneously upon initiation. In some cases, the Viet Cong will remove the integral fuze and replace it with their own, usually the pull-friction fuze.

*a. Stick Hand Grenade.* The stick hand grenade (fig. 4-1), used extensively by the Viet Cong, comes in several sizes differentiated by lengths of handle and sizes of fragmentation heads. This grenade functions by a pull string enclosed in the handle and attached to a copper wire coated with

a match compound. Normally the match compound ignites a 4-second delay element, but a number of these grenades have been found with no delay element.

#### CHARACTERISTICS

Type .....	Defensive
Color .....	Black
Maximum diameter .....	2 in.
Length .....	6 to 8 in.
Total weight .....	3 lb
Filler .....	TNT
Fuze delay .....	Approx 4 sec

*b. Defensive Hand Grenade.* The defensive hand grenade (fig. 4-2) of serrated cast iron, functions in the same manner as similar U. S. hand grenades. When the safety pin is removed and the grenade thrown, the safety lever releases the spring of the mechanical firing device which ignites the primer and delay element of the fuze. This grenade is readily adaptable to use as a boobytrap.

#### CHARACTERISTICS

Type .....	Defensive
Color .....	Black
Diameter .....	2.5 in.
Length .....	5 in.
Total weight .....	1.5 lb
Filler .....	TNT
Fuze delay .....	Approx 4 sec

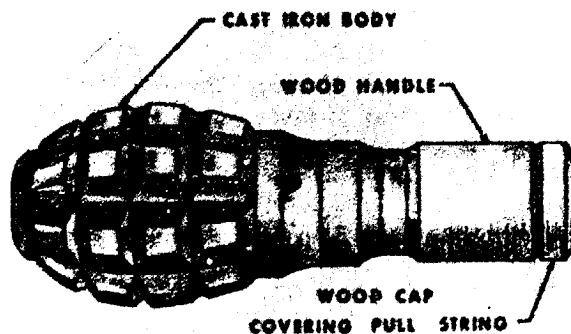

Figure 4-1. Stick hand grenade.



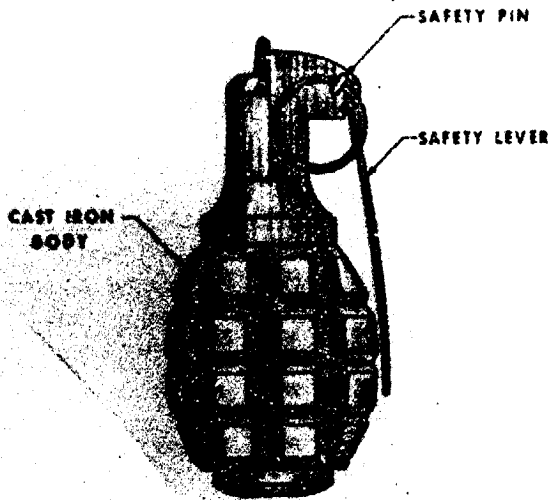

Figure 4-2. Defensive hand grenade.

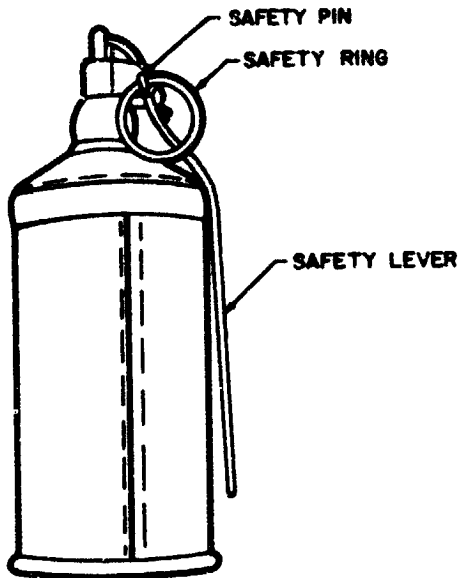

Figure 4-3. Offensive hand grenade.

*c. Offensive Hand Grenade.* The offensive hand grenade (fig. 4-3) is made of cylindrical sheet metal with crimped and soldered seams. It is normally equipped with a time delay fuze to detonate the explosive filler. These grenades must never be disassembled, since a number of them have been boobytrapped. For example, they have been found with instantaneous (no delay) fuzes. Such a fuze would prove fatal to anyone who attempted to throw this grenade. As with the defensive grenade, the offensive grenade is readily adapted to use as a boobytrap.

CHARACTERISTICS

Type .....	Offensive
Color .....	Generally black or olive-drab
Maximum diameter .....	2.6 in.
Length .....	5.4 in.
Total weight .....	1.6 lb
Filler .....	TNT of potassium chlorate
Fuze delay .....	Approx 4 sec

*d. Milk Can Hand Grenade.* The milk can hand grenade (fig. 4-4) is made from a commercial powdered milk can by cutting a hole in one end, removing most of its contents, refilling the can with cast TNT, and installing a pull-friction fuze from a stick hand grenade. Two detonators are used to insure reliable detonation of the main charge. This device is employed as a hand grenade and a boobytrap.

CHARACTERISTICS

Type .....	Offensive
Color .....	Commercial label
Maximum diameter .....	3.5 in.
Length .....	6.0 in.
Total weight .....	2 lb
Filler .....	Cast TNT
Fuze delay .....	Approx 4 sec

*e. Shaped Charge Hand Grenade.* The shaped charge hand grenade (fig. 4-5) consists of a shaped charge, a cylindrical sheet metal charge container, a conical sheet metal drag, an impact fuze mechanism, and a wood handle. The handle contains a sheet metal drag lock and pin. When the lock pin is removed and the grenade is thrown, a spring forces the conical drag back over the handle to stabilize the grenade's flight. (The drag is attached to the charge container by strips of

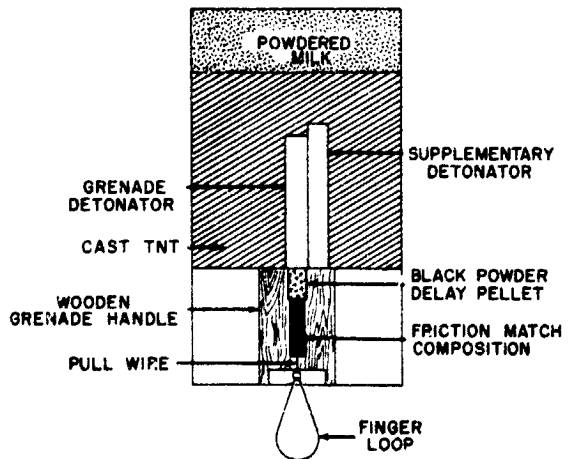

Figure 4-4. Milk can hand grenade.

material inside the cone.) When the grenade strikes, the impact fuze ignites the shaped charge.

#### CHARACTERISTICS

Type .....	Shaped charge (HEAT)
Color .....	Black or olive-green
Maximum diameter .....	3 in.
Length .....	8.75 in.
Total weight .....	Approx 1.5 lb
Filler .....	Cast TNT
Fuze delay .....	Time of flight

*f. Chinese Communist Type 42 Offensive/Defensive Hand Grenade.* The Chinese Communist type 42 offensive/defensive hand grenade (fig. 4-6) is copied from the Soviet model RG-42. The outer part of the body is a cylindrical sheet steel can with a boss riveted to one end. A threaded hole through the boss allows the fuze to be assembled to the body. The inner part of the grenade body is a sheet steel fragmentation liner which has been scored in a checkerboard pattern. The fuze assembly incorporates a spring-loaded striker held in place by a safety lever. A detonator containing a 3- to 4-second delay element is fastened to the threaded portion of the fuze housing in line with the striker. The Soviet offensive hand grenade RG-42, similar in design and function, may also be utilized.

#### CHARACTERISTICS

Type .....	Offensive/defensive
Maximum diameter .....	2.3 in.
Overall length .....	5.0 in.
Total weight .....	0.79 lb
Filler .....	Pressed TNT
Filler weight .....	3.9 oz
Fragmentation radius .....	15 meters

*g. Chinese Communist Stick-Type Defensive Hand Grenade.* The Chinese Communist stick-type defensive hand grenade (fig. 4-7) is found with a variety of head sizes and shapes; some are scored or serrated and some are not. Explosive fillers include picric acid, schneiderite, and mixtures.

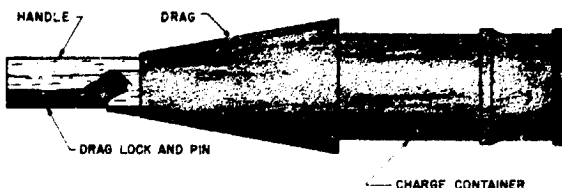

Figure 4-5. Shaped charge hand grenade.

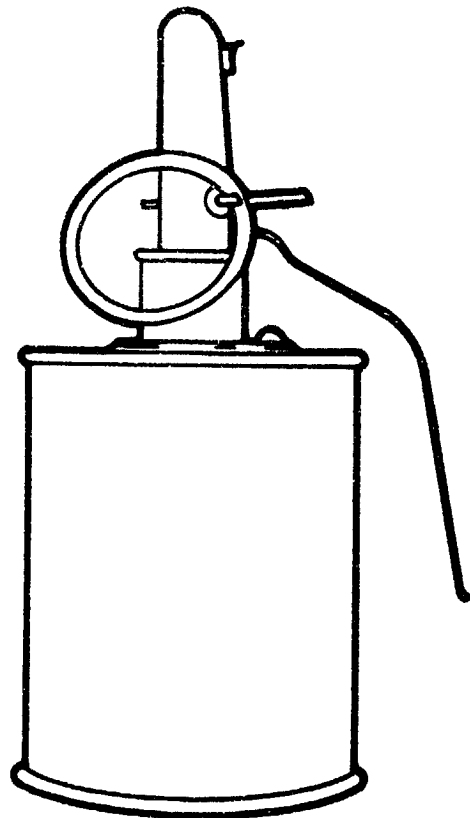

Figure 4-6. Chinese Communist type 42 offensive/defensive hand grenade.

These explosive mixtures include TNT or nitroglycerine with potassium nitrate or sawdust. All stick-type defensive hand grenades function in the same manner. The cord of a pull-friction fuze is located underneath the cap at the end of the throwing handle. A tug on this cord ignites a delay element, 2.5 to 6 seconds later the detonator explodes the main charge. Stick-type hand grenades are dangerous; they should be handled only when necessary and then only with caution.

#### CHARACTERISTICS

Type .....	Defensive
Maximum diameter .....	1.7 to 2.2 in.
Overall length .....	8.0 to 9.7 in.
Total weight .....	1.16 to 1.22 lb
Filler .....	Varies widely
Filler weight .....	0.9 to 2.2 oz
Fragmentations radius .....	10 meters

*h. Chinese Communist Type 1 Defensive Hand Grenade.* The Chinese Communist type 1 defensive hand grenade (fig. 4-8), copied from the Soviet model F-1, has a serrated, cast iron body, a cast



Figure 4-7. Chinese Communist stick-type defensive hand grenade.

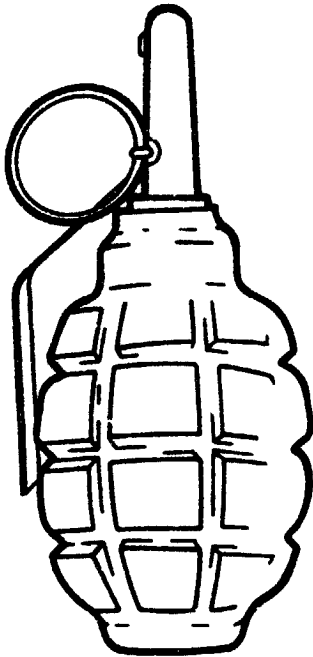

Figure 4-8. Chinese Communist type 1 defensive hand grenade.

TNT charge, and a delay fuze. A brown plastic plug threaded into the fuze well in the top of the body prevents the entry of moisture and foreign matter. The fuze consists of a delay detonator, housing, spring-loaded striker, safety lever, and a safety ring. As the grenade is thrown, the compressed striker spring forces the striker down into the primer and ignites the delay. After 3 to 4 seconds, the delay initiates the detonator, which then sets off the charge of TNT. This grenade is easily adapted to use as a boobytrap. The Soviet F-1 hand grenade itself may also be used.

**CHARACTERISTICS**

Type .....	Defensive fragmentation
Maximum diameter .....	2.2 in.
Overall length .....	4.9 in.
Total weight .....	1.28 lb
Filler .....	Cast TNT
Filler weight .....	1.94 oz
Fragmentation radius .....	15 meters

i. *Chinese Communist Type 59 Defensive Hand Grenade.* The Chinese Communist type 59 defensive hand grenade (fig. 4-9), copied from the Soviet RGD-5, has an egg-shaped, sheet metal body which incloses a nonserrated fragmentation liner. The fuze is a conventional cocked-striker mechanism which functions in the following manner: First, the safety ring and pin are withdrawn. Then, when the safety lever is released, the compressed striker spring drives the striker into the primer. The primer ignites a 3- to 4-second delay element which in turn initiates a detonator to explode the main filler charge of TNT.

**CHARACTERISTICS**

Type .....	Defensive fragmentation
Maximum diameter .....	2.1 in.
Overall length .....	4.5 in.
Total weight .....	6.8 lb
Filler .....	TNT
Filler weight .....	3.9 oz
Fragmentation radius .....	20 meters

j. *Soviet RGD-33 Offensive and Defensive Hand Grenade.* As an offensive weapon the RGD-33 hand grenade (fig. 4-10) has a 5.5 yard lethal radius. By adding a fragmentation sleeve, it becomes a defensive grenade with a 25 meter lethal radius. This sheet metal grenade is normally painted olive brown. Duds are extremely dan-

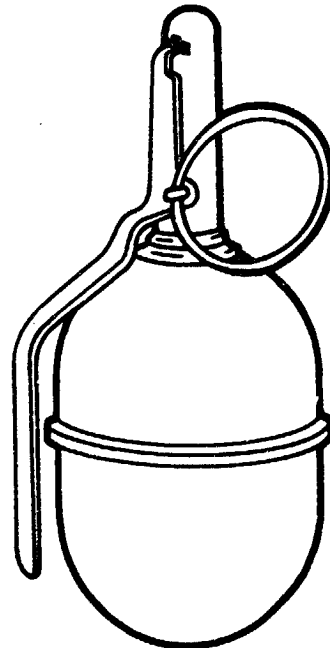

Figure 4-9. Chinese Communist type 59 defensive hand grenade.

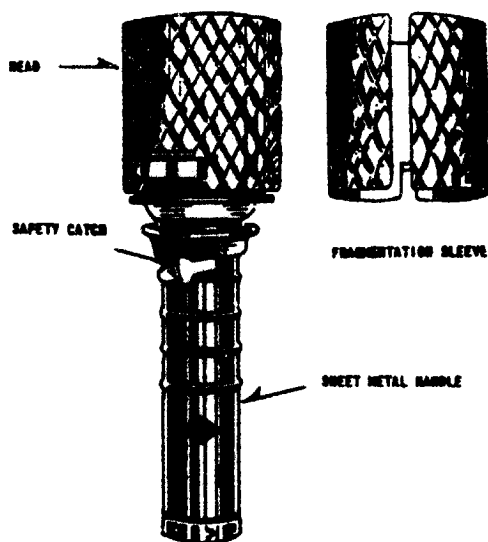

Figure 4-10. Soviet RGD-33 offensive and defensive hand grenade.

gerous and should be destroyed in place as the slightest vibration may set them off.

CHARACTERISTICS

	Offensive	Defensive
Weight	1.1 lb	1.5 lb
Length	7.5 in.	7.5 in.
Diameter	1.8 in.	2.1 in.
Time fuze	3-4 sec delay	3-4 sec delay
Effective fragmentation radius	5 meters	25 meters

k. Soviet Antitank Hand Grenade, RPG-6. This antitank hand grenade, RPG-6 (fig. 4-11), a shaped charge grenade, can be used against personnel because of its effective fragmentation radius. The grenade is thrown from cover. When thrown, the grenade is balanced by four pieces of parachute cloth that eject from the handle as the safety lever is released and ejected. The grenade explodes on impact. This granade can be distinguished from the RPG-3 grenade by its crescent shaped head and sheet metal handle.

CHARACTERISTICS

Weight	2.4 lb
Length	13.5 in.
Fuze	Impact
Penetration	4 in.
Fragmentation radius	20 meters

l. Soviet RPG-43 Antitank Hand Grenade. This weapon (fig. 4-12) is used to attack armored cars and fortified defensive positions. To insure that the head of the grenade (shaped charge) strikes

the target, an equilibrium device consisting of two pieces of cloth and a steel cone provides a drag to stabilize the right of the grenade in the correct attitude. The grenade explodes upon striking the target.

CHARACTERISTICS

Type	Shaped charge
Weight (including fuze)	2.7 lb
Length	12 in.
Fuze	Impact
Penetration	3 in.
Fragmentation radius	20 meters

m. Soviet RKG-3 HEAT Hand Grenade Family. The Soviet RKG-3 HEAT hand grenade family (fig. 4-13) comprises the RKG-3, RKG-3M, and RKG-3T, all similar in appearance. Each has a handle which contains a parachute shaped stabilizer, a middle section which contains a fuze assembly, and a head which contains a shaped charge. When any one of these grenades is thrown, a spring inside the handle ejects the stabilizer, which keeps the shaped charge pointed in the direction the grenade was thrown. When the grenade strikes the target or other hard object,

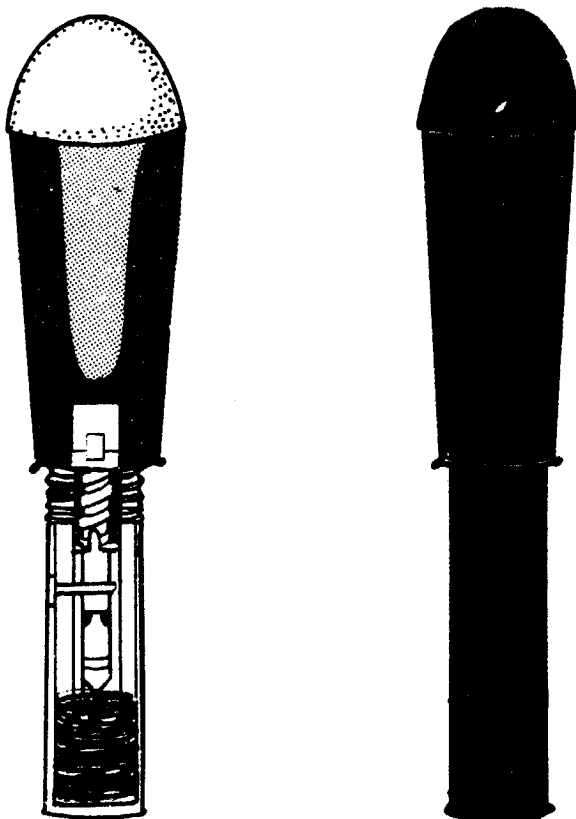

Figure 4-11. Soviet antitank hand grenade, RPG-6.

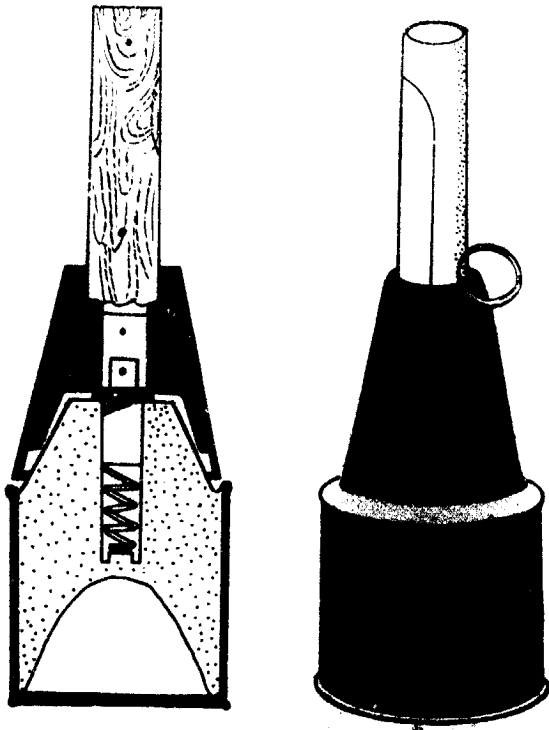

Figure 4-12. Soviet RPG-43 antitank hand grenade.

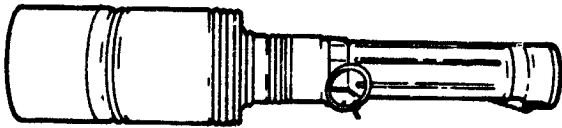

Figure 4-13. Soviet RKG-3 HEAT hand grenade family.

inertia causes a firing pin to strike a primer, which in turn initiates a detonator to explode the main charge. Like other grenades, this type of grenade can be used in a boobytrap role.

**CHARACTERISTICS**

Type .....	Shaped charge
Maximum diameter .....	2.2 in.
Overall length .....	14.2 in.
Total weight .....	2.14 lb
Filler .....	TNT/RDX mixture
Filler weight .....	20 oz
Penetration .....	Approx 7 in.

*n. Viet Cong Four-Sided Shaped Charge Hand Grenade.* This grenade (fig. 4-14) is constructed by soldering a shaped insert to the bottom and then attaching the sides and top of the grenade. The insert itself is one piece of metal. Removal of the safety pin and release of the grenade handle allows the cocked striker to ignite a delay element

which in turn detonates the grenade. The four-sided shaped charge concentrates the force of the explosion away from the center of the grenade, increasing its ability to inflict casualties.

**CHARACTERISTICS**

Color .....	Olive drab
Shaped charge .....	Crushed or powdered tritonal
Markings .....	Letters AT on fuze
Fuze material .....	Pot metal with steel handle
Height .....	6 1/4 in.
Width .....	3 1/4 in.
Body .....	1/2 in. steel
Weight .....	Varies

*o. Fragmentation Explosive Device.* This device (fig. 4-15) is designed as a hand grenade or anti-personnel mine. The body consists of a cylindrical container of light sheet metal or tin with end pieces that are secured by crimping. The initiating device is a pull friction device with a 3 to 4 second French safety fuze for delay. There is no booster. The main charge is shaved blocks of French cast explosive or TNT. Fragments of glass, stone, pottery, or metal are placed between the explosive and the walls of the body. This device is handmade from nonstandard materials and as a consequence extreme caution should be exercised in handling it.

**CHARACTERISTICS**

Height .....	4 1/2 in.
Diameter .....	2 1/2 in.
Explosive .....	TNT
Fuze .....	Pull friction

*p. Soviet RPC-40 Hand Grenade.* This grenade (fig. 4-16) is designed for use against lightly armored vehicles. The main charge is TNT encased in sheet metal. The primer-detonator is inserted into the grenade before it is thrown. The instantaneous impact igniting device is placed in the handle which is tightly screwed into the top of the grenade. When the safety pin is removed and the safety lever released, the grenade is armed.

**Caution:** Under no circumstances should dud grenades of this type be picked up as the fuze may be armed and a slight vibration will set the grenade off.

**CHARACTERISTICS**

Weight .....	2.7 lb
Length .....	7.87 in.
Diameter .....	3.75 in.
Effective fragmentation radius .....	20 meters
Fuze .....	Impact/Instantaneous

**4-3. Explosive Boobytraps.** The variety of situations and equipment conducive to boobytrapping is infinite. No attempt will be made to discuss ex-

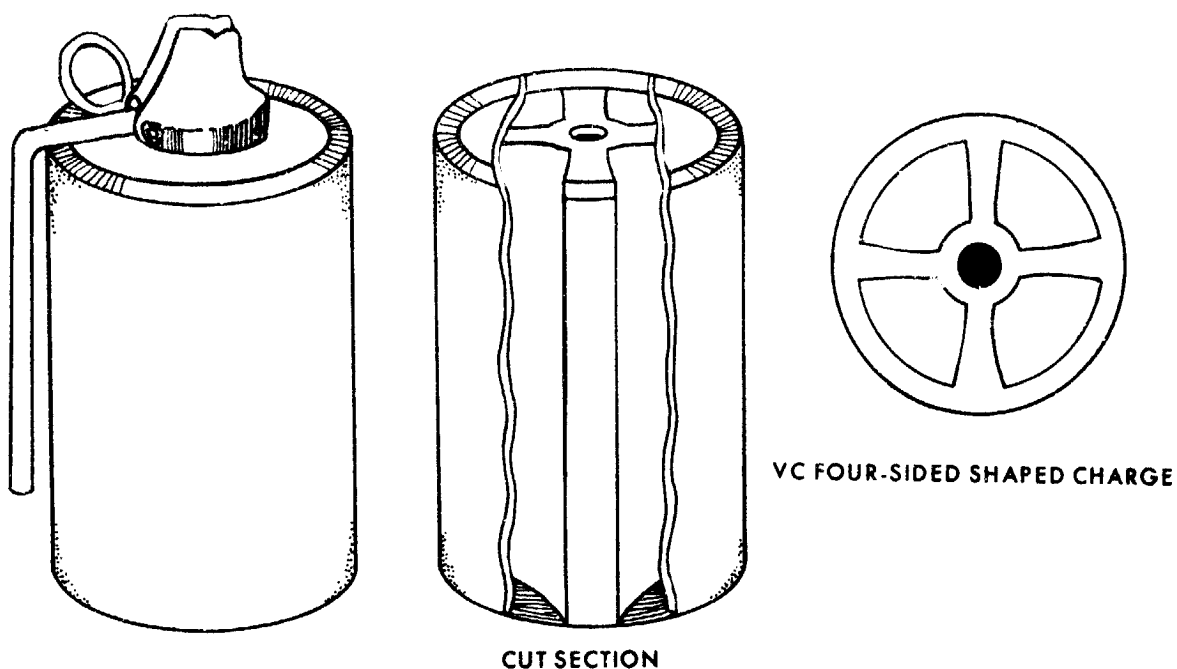

Figure 4-14. Four-sided shaped charge hand grenade.

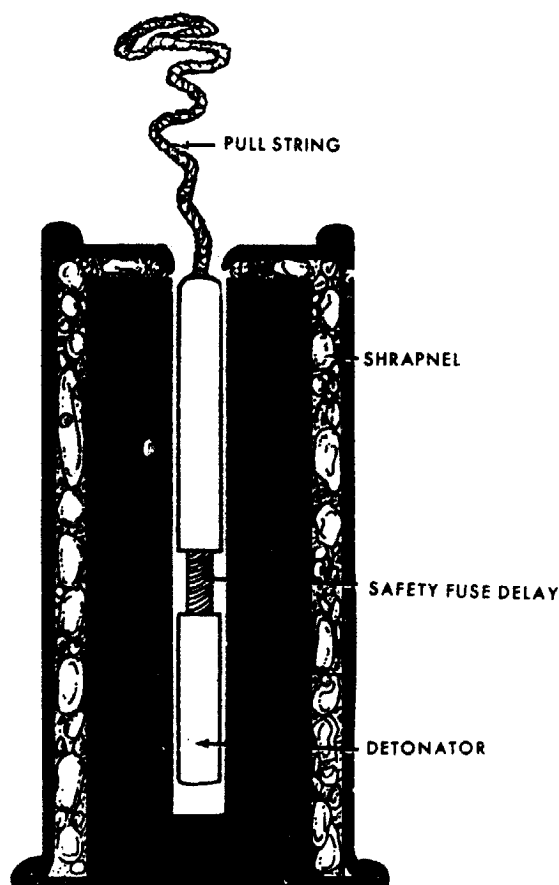

Figure 4-15. Fragmentation explosive device.

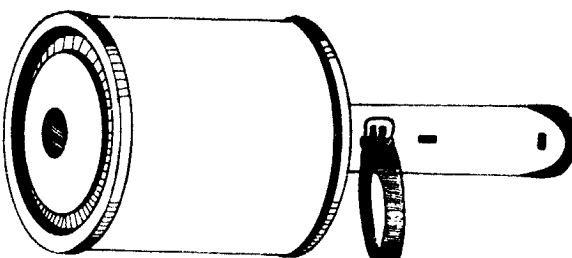

Figure 4-16. Soviet RPC-40 hand grenade.

haustively all possibilities. However, explosive boobytraps discussed in this section are known to have been employed by the Viet Cong. The study of these examples will establish patterns of Viet Cong boobytrap employment which should warn the soldier when similar related situations appear. For example, the Viet Cong often employ boobytraps in multiples. As rescue and other personnel gather at the scene of an initial explosion, a second mine or boobytrap is detonated, inflicting additional casualties. As a consequence, all personnel should proceed with extreme care when such a situation occurs. To the average soldier, the most important requirement is to recognize that a boobytrap exists or that a boobytrap potential exists rather than to know all the detailed mechanics of Viet Cong boobytrap construction. Although hand grenades are used as the explosive element in many Viet Cong boobytraps, all types of explosives may be used. Examples using hand

grenades are not restricted to this type of explosive only.

*a. Grenade Trap.* Grenade trap is a term applied to almost any boobytrap in which hand grenades are employed. The general scheme is a tripwire attached to a grenade placed along a likely avenue of approach. The tripwire may be attached to the safety pin of the grenade, which, when pulled, will initiate the firing chain of the grenade. In other applications, the safety pin may be removed and the grenade placed so that the lever is held in the safe position. The tripwire is then attached to the grenade so that a pull on the wire will release the safety lever. Another application of a grenade trap is to place the grenade under an object with safety pin removed. Movement of the object will initiate the grenade. Figure 4-17 portrays a grenade trap in its simplest form—a grenade alongside a trail with the tripwire across the trail. Examples of grenade trap variations follow in subsequent subparagraphs. In all illustrations the grenade and tripwire are plainly indicated; in actuality, both are extremely difficult to detect in the dense foliage of South Vietnam.

*b. Hand Grenade in Can.* A commonly employed grenade trap is an armed, lever-type grenade with delay element removed and with tripwire attached, placed in a can (fig. 4-18). The can must be large enough to accept the whole grenade but small enough to hold the lever in the safe position. A pull on the tripwire pulls the grenade from the

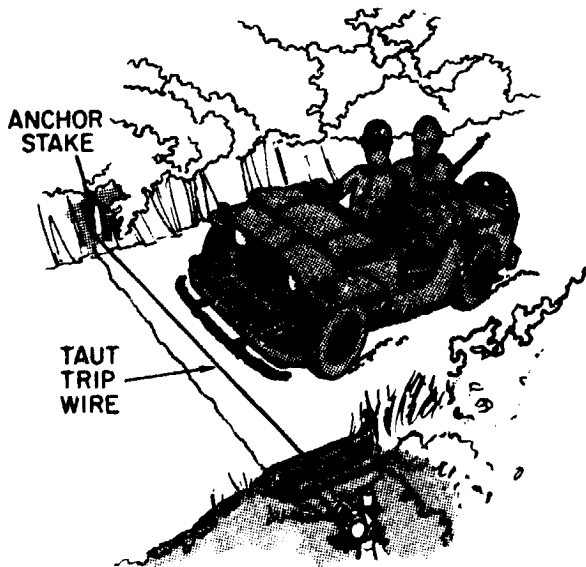

Figure 4-17. Grenade trap.

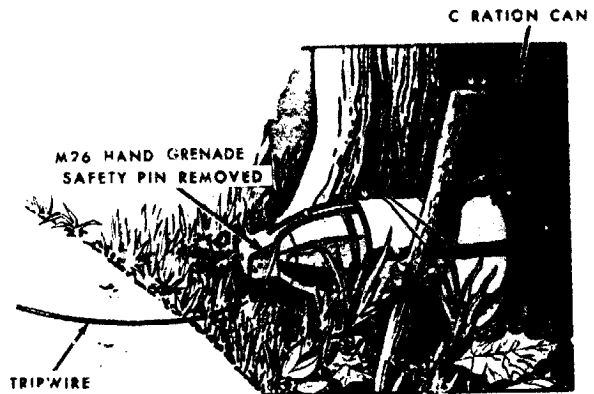

Figure 4-18. Hand grenade in can.

can, releasing the lever and firing the grenade. The U. S. M26 hand grenade has been the most commonly used grenade for this purpose. The U. S. C-ration can has been used most often as the receptacle. An appropriate sized hollow bamboo section has also been adapted to this application. In this and other applications of hand grenades as boobytraps, the delay element is usually removed from the grenade fuze, resulting in instantaneous detonation after initiation. For this reason, troops should be cautioned against attempting to reuse hand grenades found in the field.

*c. Bamboo Arch.* As a departure from the conventional horizontal tripwire, the Viet Cong employ a vertical tripwire from a bamboo arch placed across a trail (fig. 4-19). The grenade with delay element removed is secured to the top of the arch, and a tripwire extended from the safety pin to the ground. Any contact with the tripwire will pull the pin and detonate the grenade. The location of the grenade achieves a larger casualty radius than a grenade placed near the ground. This device is employed most effectively at night as a warning against approaching troops. During the day, the tripwire is loosened from the ground and wound around the bamboo arch to allow use of the trail by the Viet Cong.

*d. Tank Boobytraps.* This boobytrap (fig. 4-20) is intended to inflict casualties among troops riding on tanks. It consists of two bamboo poles, approximately 15 feet high, spaced 30 to 40 feet apart, with wire suspended between the two poles. Two grenades with delay elements removed are attached to the wire, the lowest part of which is about 10 feet from the ground. A pull wire is attached to the safety pin of each grenade and anchored to the poles. It is intended that a tank, or

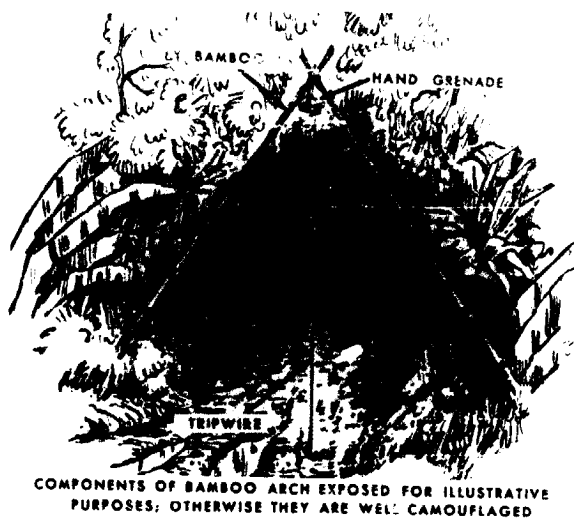

Figure 4-19. Bamboo arch.

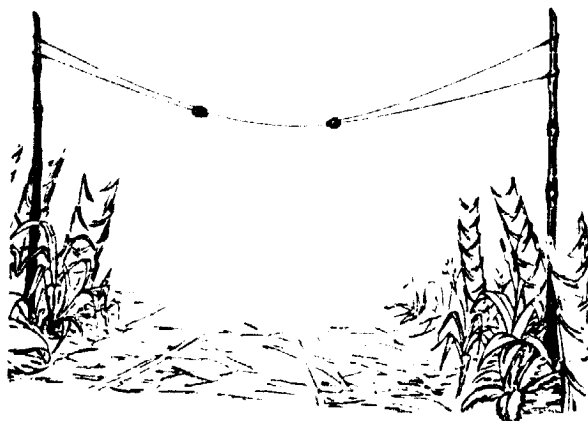

Figure 4-20. Tank boobytrap.

other vehicle in which troops are riding, will strike the overhead wire, pull the pins, and detonate the grenades. Barbed wire has been suspended between the poles; however, any type of wire may be used.

*e. Boobytrapped Gate.* A common sight in Vietnam is a gate in a fence or wall which incloses a wide variety of Vietnamese facilities. Equally as common is the boobytrapping of gates by the Viet Cong (fig. 4-21). Gates are usually boobytrapped with a hand grenade in one of two ways: a grenade is placed near the gate with a tripwire attached and extending to the gate; or a grenade, with safety pin removed, is placed under the gate

so that the grenade lever is held in the safe position. In either case, movement of the gate detonates the grenade. As with other Viet Cong boobytraps, the grenade and tripwire (if used) are extremely well camouflaged; close inspection of gates is required to detect possible boobytraps. It is a simple matter to boobytrap a gate and all personnel should be aware of the danger inherent in this natural boobytrap situation.

*f. Boobytrapped Viet Cong Flag and Banner.* By custom, the Vietnamese fly many flags and banners, and the Viet Cong are no exception. Counting on U. S. and South Vietnamese forces' tendency to dismantle or remove their flags and banners, the Viet Cong often boobytrap them. One method of boobytrapping a flag is illustrated in figure 4-22. The flag is attached to the top of a pole, and an explosive charge is fastened to the pole just below the flag. A pull wire is attached to the flag and a pull fuze to the charge, and the entire assembly (except flag) is camouflaged with leaves. An attempt to remove the flag initiates the pull fuze, detonating the explosive charge. The Viet Cong banner is usually boobytrapped at the base of one or both poles. In this application, a hand grenade or other explosive charge may be placed near the base of the pole with a pull wire

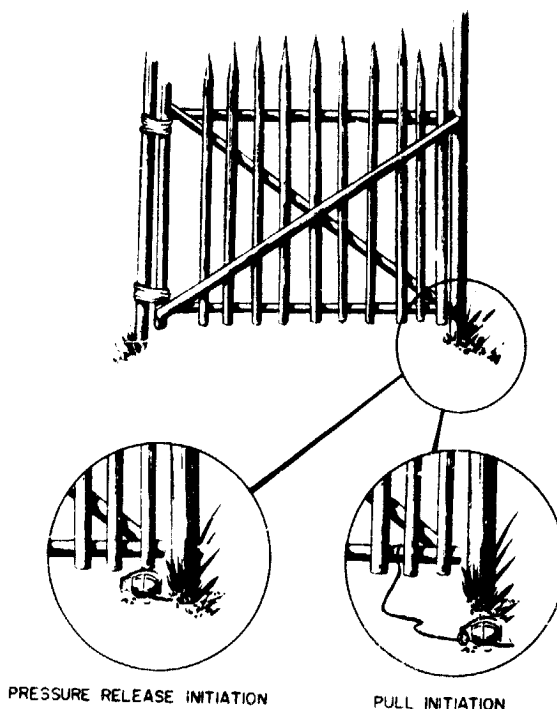

Figure 4-21. Boobytrapped gate.



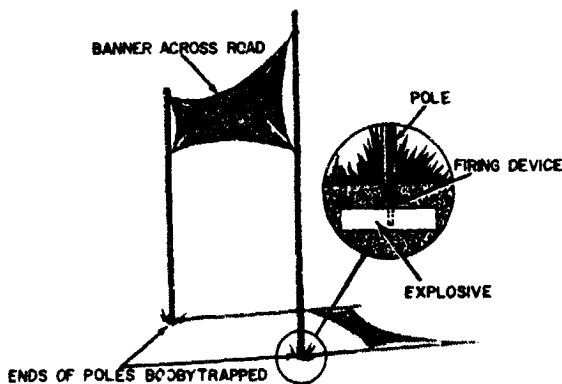
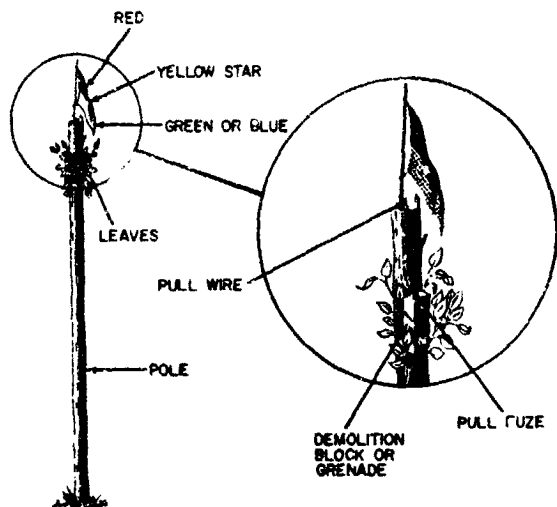

Figure 4-22. Boobytrapped Viet Cong flag and banner.

attached to the pole and a pull fuze in the charge. A hand grenade or explosive charge also may be placed under the pole for pressure release initiation. An attempt to remove the pole or push it over will initiate the boobytrap. Often signs or slogans insulting or infuriating to American soldiers will be boobytrapped. The expected emotional reaction against the sign will result in casualties.

*g. Cartridge Trap.* The cartridge trap (fig. 4-23) consists of a cartridge set into a piece of bamboo fastened to a board and installed in a camouflaged hole in the ground. A nail driven through the board serves as a firing pin. The weight of a man stepping on the upper end of the cartridge forces the nail into the cartridge to initiate the primer. The bullet is then propelled upward through the man's foot. Although the bullet must extend far enough above ground level to insure that maximum weight is exerted against the nail

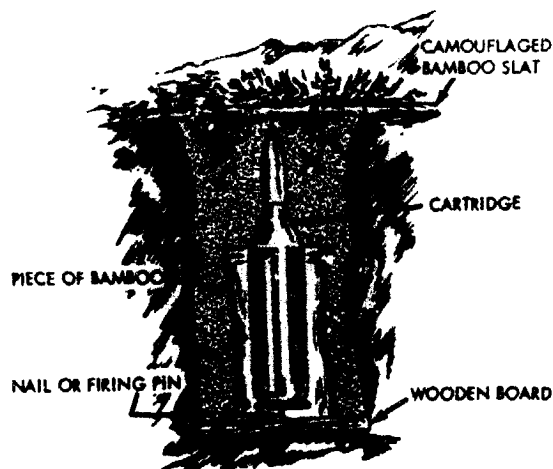

Figure 4-23. Cartridge trap.

or firing pin, this device is very difficult to detect in grassy areas.

*h. Bicycle Mine.* The bicycle mine (fig. 4-24) is made from an ordinary bicycle by filling part of the tubular frame with explosive, installing an electric detonator in this explosive, and connecting the detonator to batteries and a wristwatch firing device in the headlight housing. The bicycle explodes when, after a preset time interval, the wristwatch hand touches an electric contact and the circuit through the detonator is completed. This mine can be varied by connecting the detonator directly to the headlamp power generator. When the bicycle is moved, the generator sends an electric current through the detonator to cause the explosion. Directional mines may also be concealed in saddle bags or other such bicycle equipment. A variation of this technique uses an automobile or panel truck with body panels stuffed with explosive. This is excellent for terrorist activities.

*i. Caliber .22 Fountain Pen.* The caliber .22 fountain pen (fig 4-25) is actually a weapon which fires a .22 caliber rimfire cartridge. It is used by Viet Cong agents for assassinations. The illustration in figure 4-25 shows the pen in the uncocked position. When the device is cocked, the round stud (part of the firing pin) will be located in the notch at the left end of the slot in the cap. If the stud is pushed out of the notch, a compressed spring will drive the firing pin into the cartridge, causing it to fire. This device can be adapted to a cigarette lighter. The device also can be adapted as a boobytrap by mounting it in such a position

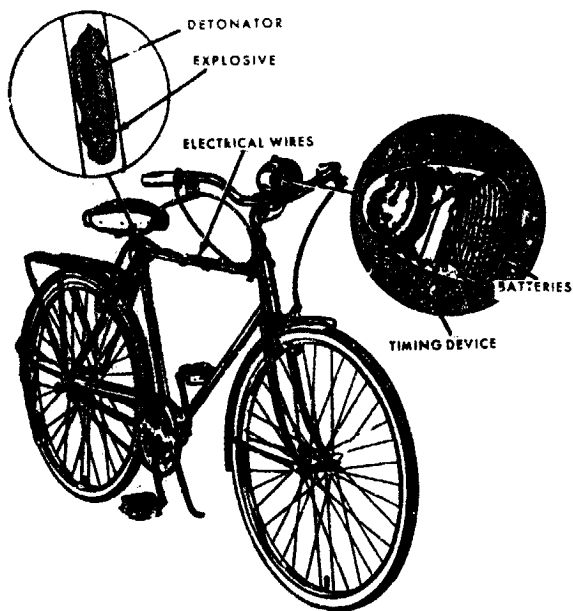

Figure 4-24. Bicycle mine.

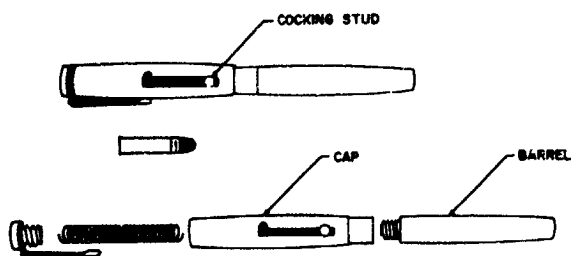

Figure 4-25. Caliber .22 fountain pen.

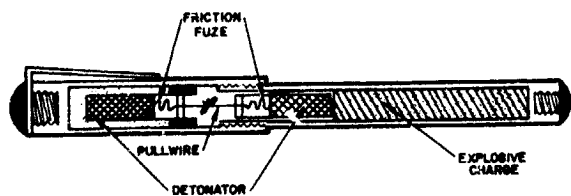

Figure 4-26. Explosive fountain pen.

that it is pointed in the direction of an intended victim and installing a simple means of releasing the cocking stud from the notch.

*j. Explosive Fountain Pen.* The explosive fountain pen (fig. 4-26) is another type of boobytrap or harassing device. When the cap is unscrewed and removed from the barrel of the pen, two friction fuzes function and both cap and barrel explode in the hands of the person holding the pen.

*k. Sodium Incendiary Device.* The sodium incendiary device (fig. 4-27) is constructed of two sheet metal hemispheres welded together and containing sodium suspended in a tar-like substance. The body has two holes in its outer surface. A wax and paper covering over the holes waterproofs the item when in storage. When the device is emplaced, the wax cover is removed, allowing water to contact the sodium and thereby creating heat and flame. This device is often emplaced in boat bilges and is particularly effective in an area with oil or gas seepage.

**CHARACTERISTICS**

Type	-----	Incendiary
Color	-----	Black
Diameter	-----	1.5 in.
Weight	-----	1.5 oz
Filler	-----	Sodium

*l. Cigarette Lighter.* This device (fig. 4-28) has the outward appearance of a common cigarette lighter sold commercially in the Republic of Vietnam. The explosive device is located in the fluid compartment and is composed of a detonator and explosive charge. The detonator is a fast-burning cotton wick saturated with flammable powders. The explosive replaces the original cotton in the fluid compartment. The device is detonated when the flint is struck, causing the detonator to ignite and set off the explosive charge. Figure 4-28 shows two lighters commonly used for this purpose.

*m. Multiple Highway Obstacles.* The Viet Cong take advantage of the American dislike of repetitive, monotonous tasks in their boobytrap efforts. For instance, the Viet Cong construct a series of

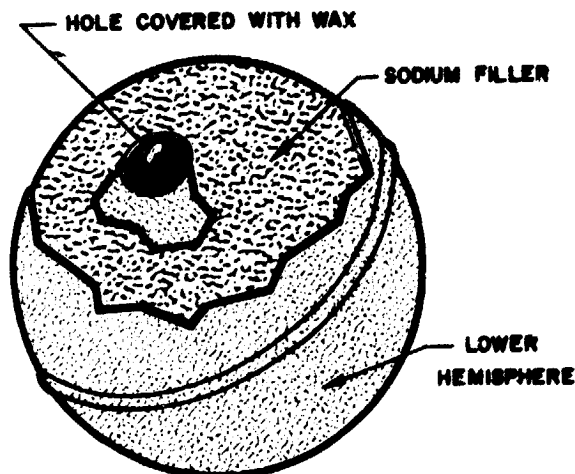

Figure 4-27. Sodium incendiary device.

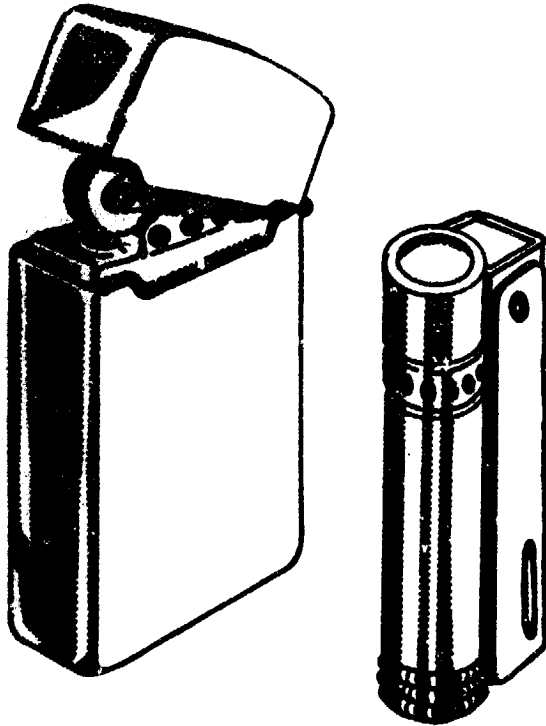

Figure 4-28. Cigarette lighters.

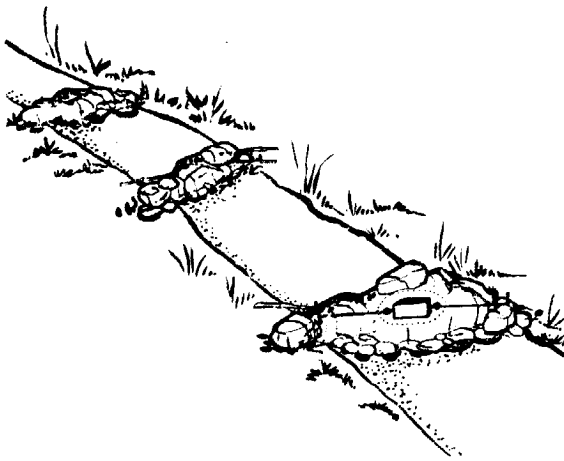

Figure 4-29. Multiple highway obstacles.

two or more highway obstacles positioned so that one crew or team will probably be required to move the entire series (fig. 4-29). Then the Viet Cong construct a boobytrap in one of the obstacles which will be moved later in the clearing operation. The obstacles will be similar in construction to further associate the mined obstacle with its

unmanned predecessors. Only a conscientious, careful mine search of each obstacle will prevent casualties in the clearing of road obstacles.

*n. Boobytrapped Caches.* The Viet Cong frequently place boobytraps in caches (fig. 4-30) that they anticipate will be discovered. Several units suffered multiple casualties while removing material from a captured Viet Cong cache. Although proper dispersion and security were maintained while searching the adjacent structure and area, personnel concentrated to help remove the captured material. Hidden boobytraps were then accidentally detonated causing multiple casualties in several instances. A typical boobytrap in this instance is a grenade with instantaneous fuze and without safety pin hidden under adequate material to keep the safety lever depressed. Removing the material above the grenade frees the safety lever and detonated the grenade. One man at a time should search Viet Cong caches to preclude multiple casualties.

*o. Tree Mounted Boobytraps.* An excellent application of mortar and artillery rounds (usually 75 to 105mm) is the treetop boobytrap (fig. 4-31). Mortar or artillery shells are suspended and camouflaged in trees. As friendly forces move under the suspended shells, they are command detonated. This technique is particularly effective against troops who do not habitually exercise overhead security.

*p. Thatched Roof Grenades.* The Viet Cong have concealed grenades in the thatched roofs of structures (fig. 4-32) which they anticipate will be burned upon discovery or capture. The pins were pulled and the safety levers were tied with string

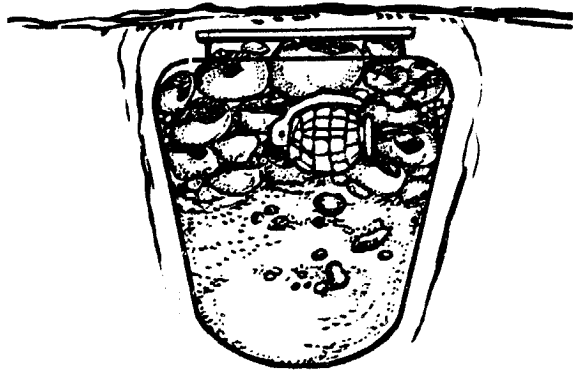

Figure 4-30. Boobytrap hidden in cache.

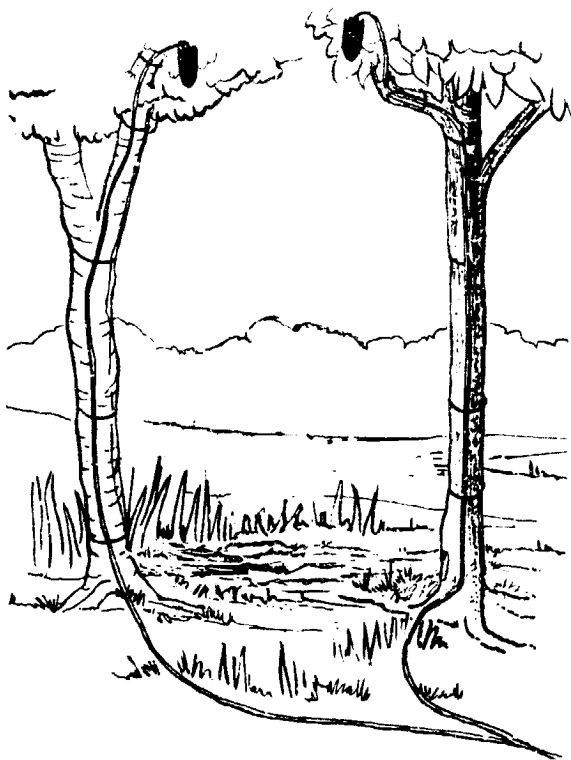

Figure 4-31. Treetop boobytraps.



Figure 4-32. Thatched roof grenades.

or rubber bands. When the structures were burned, exploding grenades created a hazard among friendly troops.

q. *Fuel Tank Boobytrap.* An unattended vehicle is an invitation to receive a fuel tank boobytrap (fig. 4-33). Vehicle sabotage has been attempted by means of a grenade with pin removed and safety level held by rubber binding or adhesive tape inserted in the fuel tank. The rubber binding or adhesive deteriorates rapidly in petroleum products, releasing the safety handle. The length of delay is set by the quality or amount of binding. This simple delay device could produce casualties and equipment loss. A locking device on the fuel filler cap can be fabricated to discourage such sabotage attempts, especially in halted or slowmoving city traffic. In other instances, grenades have been found wedged in the front suspension or against tires of unattended vehicles creating a very simple boobytrap.

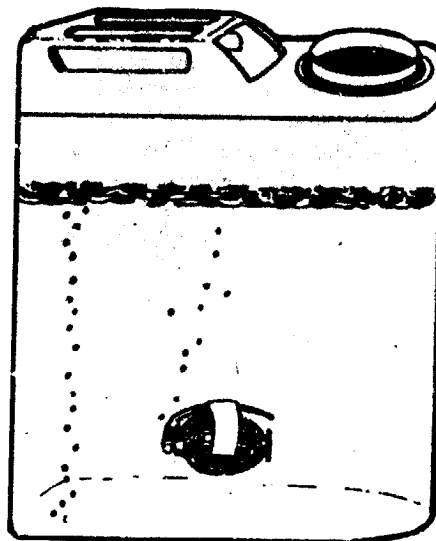

HAND GRENADE  
IN GAS TANK

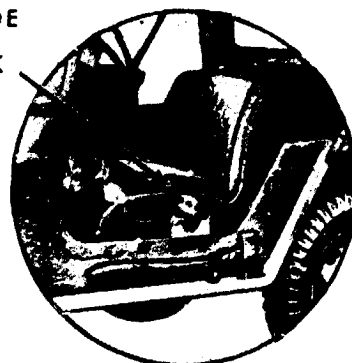

Figure 4-33. Fuel tank boobytrap.

*r. Boobytrap Disguised as a Mine.* A hand grenade with pin removed is deliberately disguised as a mine in this boobytrap (fig. 4-34). The grenade is buried under enough scrap metal to register on a mine detector. Packed dirt sufficient to hold the safety lever covers the scrap metal. The mine detecting team detects the scrap metal. As a soldier probes for the mine, he loosens and removes enough dirt to release the handle and detonate the grenade.

*s. Broken Branch Boobytrap.* The Viet Cong use two variations of the basic idea of boobytrapping an apparently harmless broken branch or limb obstructing a roadway. Both use pull type firing devices to explode a charge or series of charges as the branch is moved. One variation is designed primarily to inflict casualties on a column of troops. As the lead man moves the branch of this "roadside" boobytrap (fig. 4-35), a series of charges connected by detonating cord is fired along the line of march. The second variation utilized a branch in a wheel track of a road (fig. 4-36). As the vehicle wheel moves or drags the branch, an explosive charge is detonated under or alongside the vehicle. These boobytraps can be easily disguised by a series of harmless branches establishing a repetitive pattern to lull careless troops.

*t. Boobytrap Grenade.* This manufactured booby-trap grenade (fig. 4-37) resembles a standard fragmentation type hand grenade, except that the safety pin and pivot pin have been reversed. The grenade detonates when the safety pin is re-

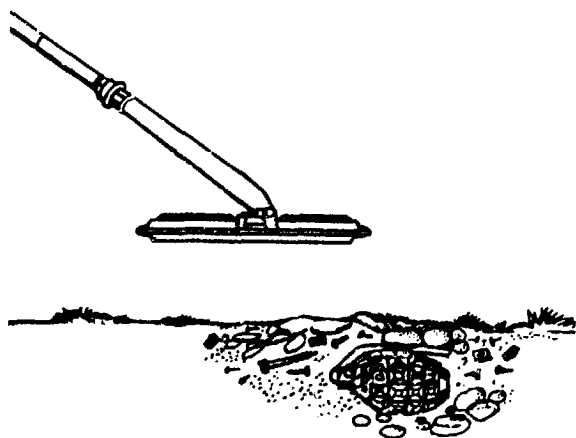

Figure 4-34. Boobytrap disguised as a mine.

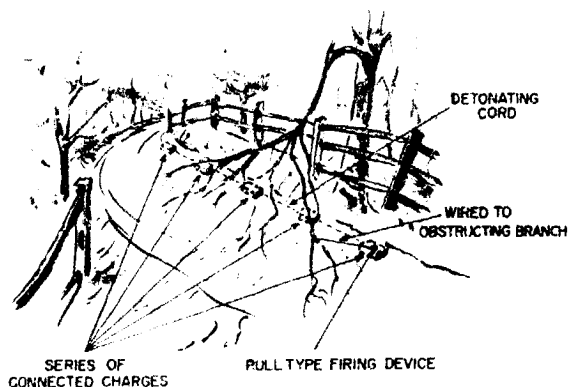

Figure 4-35. Roadside boobytrap.

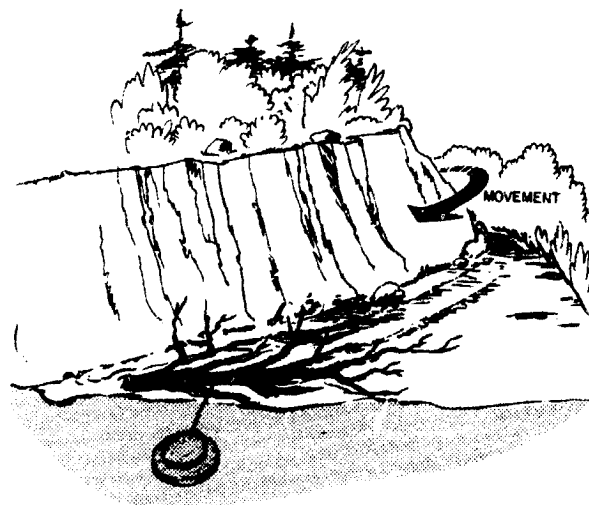

Figure 4-36. Wheel track boobytrap.

moved and pressure applied to the safety lever. This particular grenade and the Viet Cong tendency to remove the delay elements of standard grenades make an attempt to handle or use Viet Cong munitions extremely dangerous. This boobytrap may also be an M26 grenade into which the enemy may have installed and ignited a long delay fuze, up to 6 hours. There is great danger, therefore, in handling recovered U.S. munitions.

*u. Improvised Grenade Launcher.* The grenade launcher (fig. 4-38) is an improvised antiaircraft weapon used against helicopters. A 8-pound charge of TNT is placed at the bottom of a funnel-shaped hole, 2 feet in diameter and 2.5 feet deep in a potential helicopter landing zone. The charge is primed and tamped with earth to 4

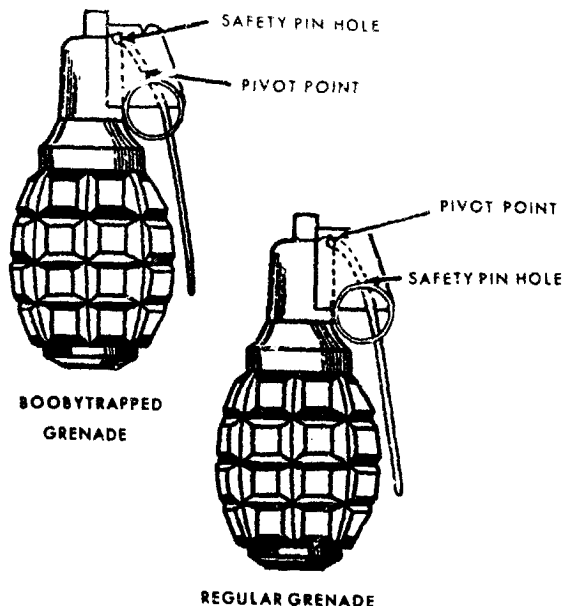

Figure 4-37. Viet Cong boobytrap grenade.

inches from the surface. A board 2 feet square with attached hand grenades is placed over the hole. The grenades are held between nails driven 3 inches apart on the board. The nails also prevent the grenade safety levers from releasing and detonating the grenade when the safety pins are removed in preparation for firing. The charge is command detonated when a helicopter is about 100 yards above the device. The grenades are thrown into the air to a height of 120 to 150 yards where they detonate and inflict damage to the helicopter and casualties among its passengers and crew.

*v. Helicopter Can Trap.* In this trap (fig. 4-39), bamboo poles are placed in the ground with a tin can attached to the top of each pole. Hand grenades with safety pins removed are placed inside the cans. Tripwires are attached to the grenades from one pole to another in an "X" pattern. When a helicopter touches the trip wires, the grenades drop to the ground and explode.

*w. Cigarette Pack Antipersonnel Device.* This device has the outward appearance of a cigarette pack (fig. 4-40). A metal container is placed inside a cigarette pack to house an explosive mixture of TNT and ball bearings. The central portion of the device is occupied by a fuze composed of an acid well, a delay membrane, an initiating compound, and a booster charge. Acid is poured into the fuze where it decomposes the delay mem-

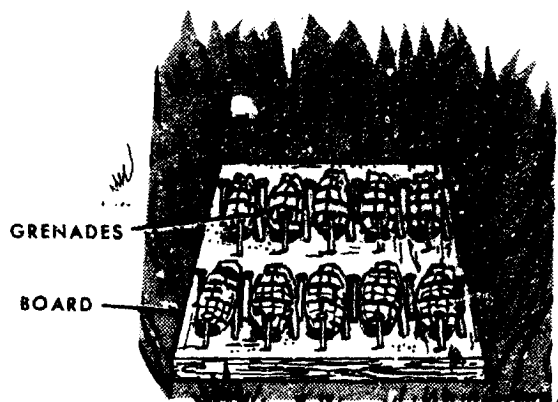
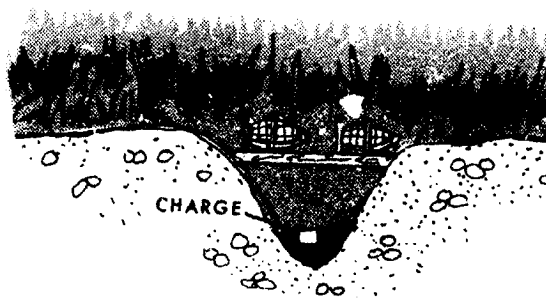
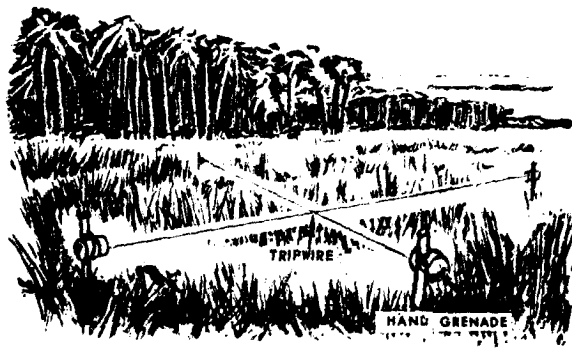

Figure 4-38. Improvised grenade launcher.



EXPOSED FOR  
ILLUSTRATIVE PURPOSES, OTHERWISE, DIFFICULT TO DETECT

Figure 4-39. Helicopter can trap.

brane and detonates the initiating compound. The device is then detonated via the booster. No attempt to disarm this device should be made. It should be placed under sandbags and allowed to detonate.

**4-4. Nonexplosive Boobytraps.** Viet Cong forces employ many nonexplosive boobytraps which are

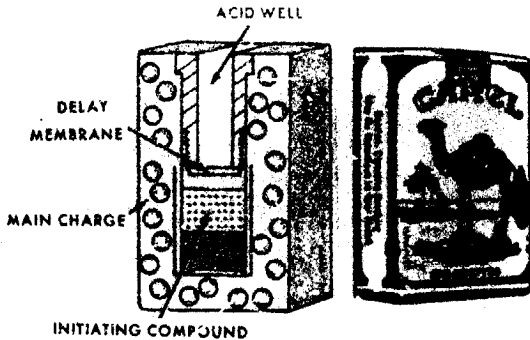

Figure 4-40. Cigarette pack antipersonnel device.

effective. These devices are all improvised and easily constructed from locally available materials. Many innovations are possible, some of which have been encountered on numerous occasions while others have appeared less frequently. It is important to know that these boobytraps, however crude, are being employed, for in the past they have succeeded in their primary purpose of inflicting casualties.

a. *Barbed Spike Plate.* The barbed spike plate (fig. 4-41) consists of metal spikes fastened to a wooden board. The spikes vary greatly depending upon the materials available. The simplest form of spike plate is devised with nails driven through a board; the nails may be sharpened or even barbed. Metal rods, such as welding rods, may be fastened to boards and either pointed or barbed. The most deliberate form of spike board is made of forged metal stakes which are pointed and barbed. These small spike boards may be employed a few at a time or in large quantities to impede the movement of foot troops. They are normally placed on the ground but may also be placed in shallow holes. In any case, they are difficult to detect in the dense grass and undergrowth. Stepping on one of these devices results in a serious foot wound requiring evacuation of the victim.

*Note.* A variation of this technique combines barbed stakes with a pressure release explosive boobytrap. Punji stakes are embedded in cement or a heavy block and placed in a camouflaged hole. A pressure fuze is attached to a grenade or demolition and placed under the block holding the punji sticks. By removing either an injured man or the block itself the pressure release fuze detonates the grenade or demolitions.

b. *Crow's Foot.* The crow's foot (fig. 4-42) is a four pronged metal device, designed so that one spike will always point up when placed on the

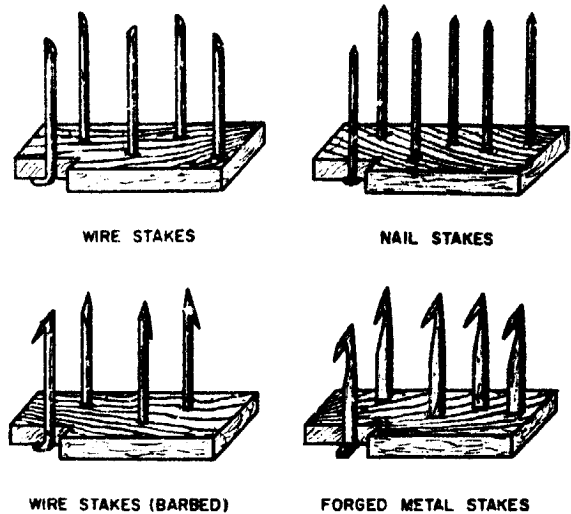

Figure 4-41. Barbed spike plates.

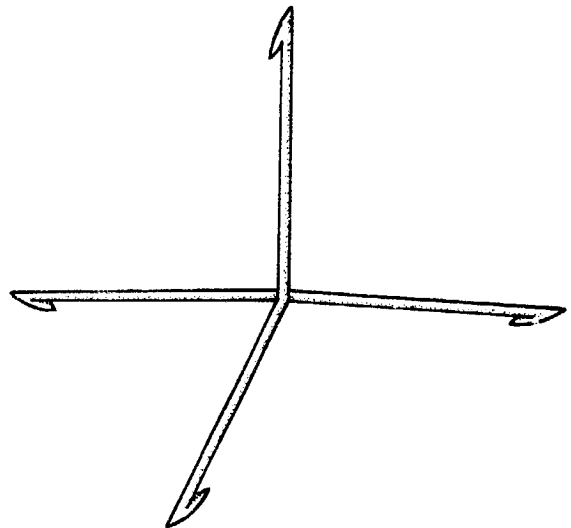

Figure 4-42. Crow's foot.

ground. The size varies from 2 to 12 inches. All spikes are barbed. The crow's foot is employed against both personnel and rubber tired vehicles.

c. *Punji Stakes.* Punji stakes (fig. 4-43) are pointed bamboo stakes placed on the ground and camouflaged. They are designed to injure or kill personnel who step or fall on them. The pointed ends are often treated with human excrement or poison so that the wounds become infected or cause death. The Viet Cong employ them in various ways. They are often used on prospective

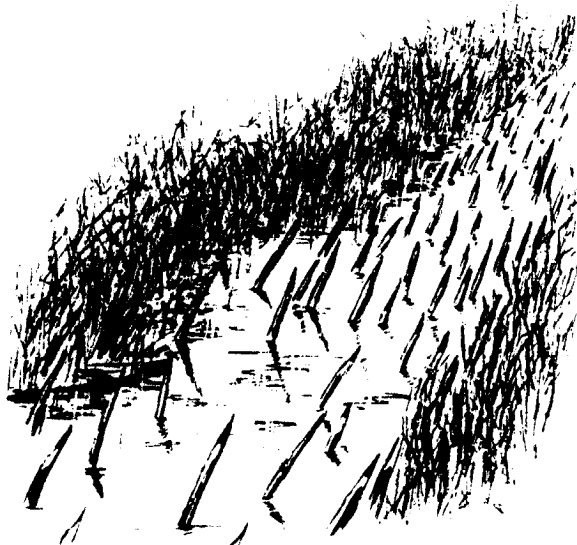

Figure 4-43. Punji stakes.

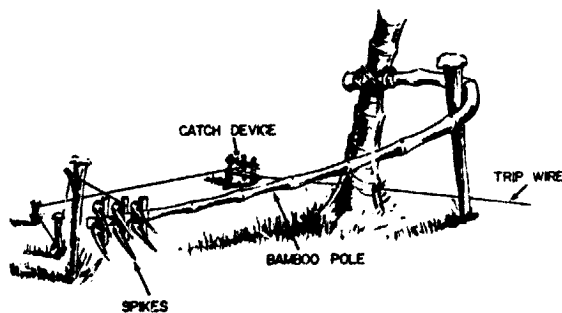

Figure 4-44. Bamboo whip.

landing zones to wound personnel as they jump from a helicopter to the ground. They are used as obstacles in Viet Cong defensive positions. They are often emplaced on the banks of gullies and streams where it is likely that troops might jump from one bank to the other. They are used along roads at entrances to villages and at ambush sites.

*d. Bamboo Whip.* The bamboo whip (fig. 4-44) consists of a piece of green bamboo several meters long, with spikes, normally sharpened bamboo, fastened to one end. The bamboo pole is bent and held in an arc position by a catch device, and a tripwire is placed across a trail or path. When a man hits the tripwire, the catch device is released, and the spiked end of the bamboo pole strikes that individual with great force at about chest height.

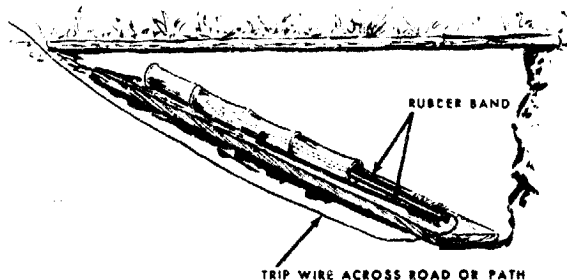

Figure 4-45. Angled arrow trap.

A variation of the whip has been reported which utilizes three or four barbed-point arrows in place of the spikes. In this application, release of the catch device hurls the arrows at the intended victims.

*e. Angled Arrow Trap.* The angled arrow trap (fig. 4-45) fires a steel arrow through a meter long bamboo "barrel" by means of a strong rubber band. The bamboo barrel is mounted on a wooden board with nails and wire. A catch mechanism secures the rubber band and arrow in a cocked position in the barrel until the boobytrap is activated. The catch is released by a tripwire. The entire trap is placed in a sloped camouflaged pit which aims the arrow to strike any person who trips the tripwire.

*f. Bear Trap.* The bear trap (fig. 4-46) is an animal trap employed to trap people. Like most animal traps, this device lies flat on the ground, held in its cocked position by a heavy spring. When a man steps on the trap, the jaws snap closed around the man's ankle or leg. Traps encountered in Vietnam are referred to as bear traps because they are considerably larger than most small game traps. Some of these devices are commercial animal traps, while others appear to have been manufactured locally. The leg wound inflicted by this device usually requires evacuation of the victim.

*g. Spike Board Pit.* The spike board pit (fig. 4-47) is simply a small pit, the bottom of which is lined with boards through which spikes have been driven. The top of the pit is camouflaged. A person stepping on the camouflage material falls into the pit and impales his foot on the spikes. These pits are generally about 18 inches square and 12 inches deep.

*h. Tilting Lid Spike Pit.* The tilting lid spike pit (fig. 4-48) is substantially the same type of trap





Figure 4-46. Bear trap.

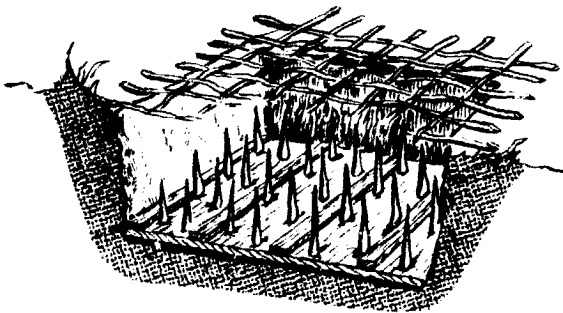

Figure 4-47. Spike board pit.

as the spike board pit. The major differences are that it is larger (about 13 feet square by 8 feet deep) and has a pivoting lid. The lid is supported in the middle by an axle; when locked in position it is strong enough to support a man's weight. When unlocked, the lid pivots when a man steps on it and the man drops into the pit onto the spike board flat covers the bottom. The lid, which is counterbalanced, then swings back to its original position. Because of the pit's depth, the walls are

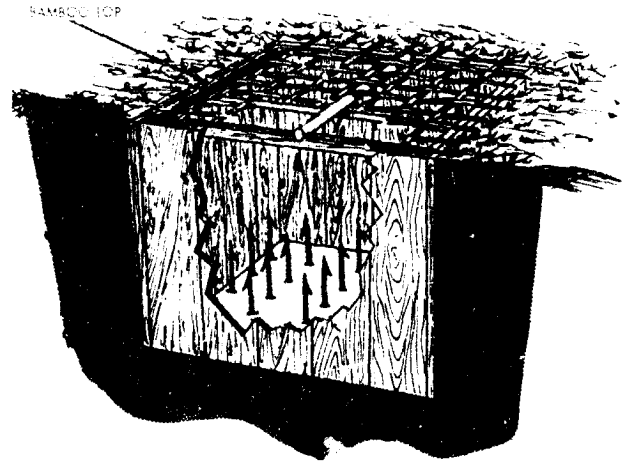

Figure 4-48. Tilting lid spike pit.

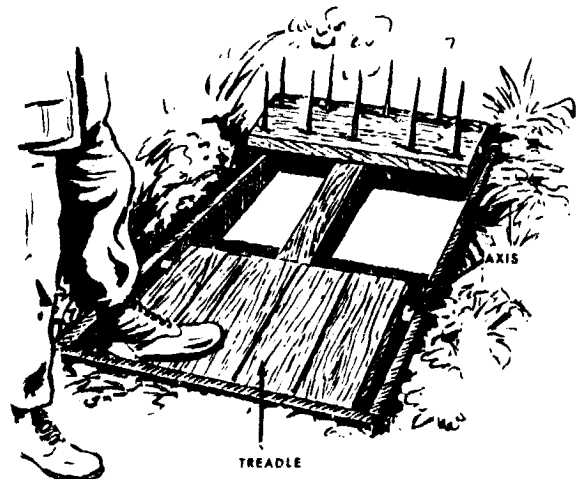

Figure 4-49. Pivoted spike board.

shored up with boards or logs to prevent cave-ins. There are variations of this type of pit which utilize less sophisticated top covers, but all are large enough to hold a man. This device is often referred to simply by its function—man trap.

*i. Pivoted Spike Board.* The pivoted spike board (fig. 4-49) consists of a lever, pivoted between a treadle on one end and a spike board on the other. The treadle is placed over a foot pit. As the victim steps on the treadle, the lever pivots about its axle dropping the victim into the foot pit and rotating the spike board upward. The spike board is designed to strike the stumbling victim in the face or chest. A variation of this device is arranged to inflict wounds on the victim's leg.

j. *Venus Flytrap (Can or Pit)*. The venus flytrap (pit) (fig. 4-50) consists of a rectangular framework with overlapping barbs emplaced over a pit, on trails, or in rice paddies. The barbs are angled downward toward the pit making any attempt to extract the leg difficult. A variation uses a metal container or can with barbed spikes protruding in and downward from the top edge. If an individual steps into one of these traps, he should bend downward or cut off the barbs before making any attempt to withdraw his leg.

k. *Sideways Closing Trap*. The sideways closing trap (fig. 4-51) consists of two wooden jaws, each studded with barbed spikes, which snap together along a pair of wooden guide rods. The trap is powered by two large rubber bands cut from automobile inner tubes. A wooden prop keeps the jaws

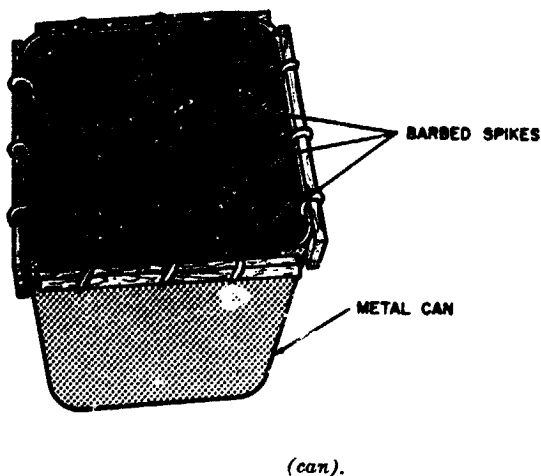
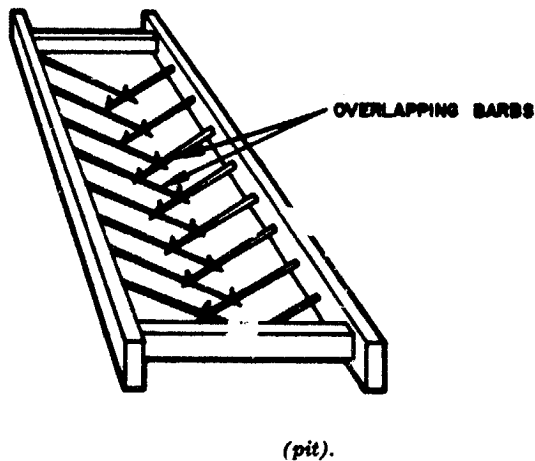

Figure 4-50. Venus flytrap.

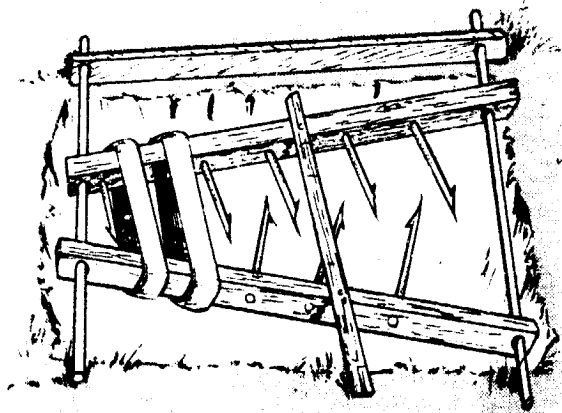

Figure 4-51. Sideways closing trap.

apart and the rubber in tension. The device is placed on the top of a 4-foot deep pit and camouflaged. As a man steps on the device he dislodges the prop. The rubber bands snap the spike jaw around him. The spikes rake his legs, abdomen, and chest until he stops falling. A variation uses a length of split green bamboo rather than wood for the jaws.

l. *Trap Bridge*. The trap bridge (fig. 4-52) is a small wooden bridge boobytrapped by partially cutting the deck and camouflaging the cut with mud. Barbed spikes are placed underneath the bridge and along the adjacent banks. Anyone crossing the bridge causes it to collapse, and becomes impaled on the spikes. Occasionally the ditch is blocked at one end to retain the water so that the spikes will be covered and less obvious. If the ditch is not blocked, the spikes are driven in level with the mud or otherwise camouflaged.

m. *Mace (Spiked Log or Ball)*. The mace (fig. 4-53) consists of a spiked ball or log suspended in a tree so that it will fall or swing onto any victim who pulls the release tripwire. One variation uses a spiked log approximately 8 to 10 feet long as the striking force in the trap. Another variation uses a concrete or mortar ball with embedded spikes

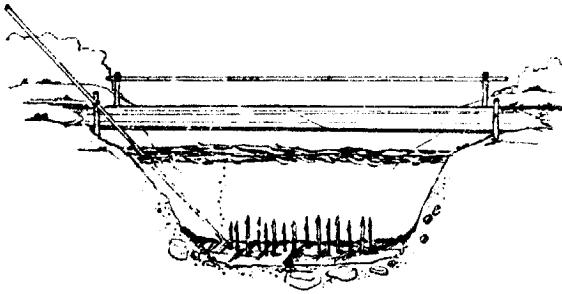

Figure 4-52. Trap bridge.



Figure 4-53. Spike log (mace).

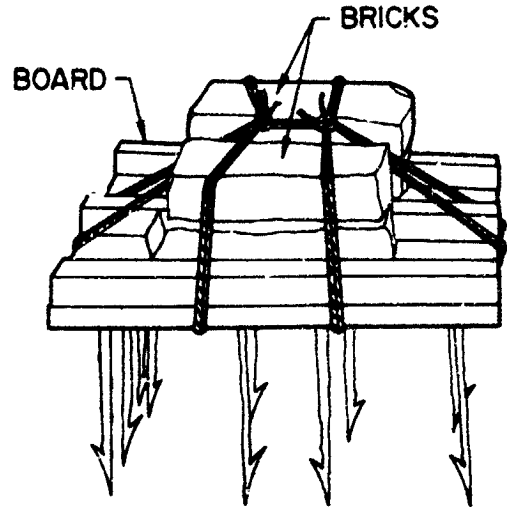

Figure 4-54. Suspended spikes.

suspended by a rope, wire, cable or other suitable line. Balls vary in size but may be as much as 24 inches in diameter and 40 pounds in weight. In either case, the momentum of the falling or swinging mace can inflict severe injury.

n. *Suspended Spikes.* The suspended spikes device (fig. 4-54), known as the tiger trap, consists of a board approximately 18 inches square with spikes protruding downward. It is weighted with bricks and suspended from the branch of a tree overhanging a path. A tripwire stretched across the path beneath the spike board, when pulled, frees the device to fall on someone below. Size and materials used for this device vary widely.

## SECTION V

### MINE WARFARE DOCTRINE

---

#### 5-1. General.

a. To the inexperienced observer, the Viet Cong do not appear to have a specific mine warfare doctrine. Such an evaluation of Viet Cong capabilities is completely erroneous and leads to serious security and tactical errors. In mine warfare, the Viet Cong know what they are doing and do it well. One of the principal reasons for erroneous evaluation of Viet Cong techniques is that, unlike U.S. doctrine, they have not to date employed mines in any standard pattern, in standard "minefields". The explanation for this is quite simple; the Vietnamese terrain and Viet Cong tactics do not lend themselves to extensive minefields and standard patterns. Therefore, the Viet Cong have adapted the use of mines to the terrain and to their particular tactical operations.

b. The mine warfare problem faced by Free World forces in RVN is unique. Nuisance mining on a massive scale is accomplished by ingenious, capable personnel who have a detailed knowledge of the terrain and environment, and who have the additional benefit of being able to move and operate in small groups at night with relative freedom. The Viet Cong lack artillery and, in essence, use mines as a replacement for artillery. The Viet Cong do not lay minefields as such and cover them by fire in the classical manner. Rather they interdict the road net in all areas, and reply to off-road operations by quick and indiscriminate mining. While they benefit directly by causing combat casualties and vehicle losses, the real benefit is psychological.

c. Enemy training documents stress that in the more isolated or less populated areas, pressure type mines should be employed. In areas of dense population, command mines are preferred. These documents stress that where mines which are not command detonated are to be employed, every means of informing the local population concerning their location commensurate with security regulations should be exhausted. Doctrine also stresses the need for being able to neutralize de-

vices so that enemy units and villages in the area will not suffer losses.

d. For all intents and purposes, the Viet Cong do have a specific mine doctrine, which, in U.S. terms, is nuisance mining in its extreme application. The purpose of this section is to synthesize field reports and observations into techniques of employment of mines and boobytraps by the Viet Cong.

e. Although there are variations with the season and locale, vehicular traffic in Vietnam is, to a large extent, restricted to roads and trails. The road network is not extensive, and roads will not support heavy traffic without constant maintenance. Bypass of disabled vehicles or obstacles in the road is difficult and often impossible in most locations.

f. This situation allows for effective nuisance mining with a relatively small investment of material resources. A primary target objective is the movement of U. S. troops, supplies, and equipment on both paved and dirt roads. Proper placement of one or two mines can disrupt an entire convoy, immobilize administrative and patrol vehicles, or trigger an ambush. Large numbers of antitank or antivehicular mines need not be, and seldom are, employed in any one location. A few mines can effectively harass and slow vehicular traffic and neutralize a large number of troops in periodic minesweeping operations. Consequently the enemy continues to concentrate his mining effort primarily on the lines of communication, to include inland waterways. Likewise a few carefully sited and emplaced antipersonnel mines or boobytraps can slow movement of foot elements such as patrols, and inflict casualties on U.S. personnel. In a war which places a high premium on tactical mobility and movement, inability to cope with carefully placed antipersonnel devices can subtract a heavy penalty from fighting effectiveness.

g. Heavy density of mining activities was also found in the vicinity of fixed installations of various types, such as airfields, logistical installations

and docking facilities. It is also very common to find numerous mines and boobytraps guarding the approaches to VC base areas in off-road locations. Based upon interrogation of prisoners and upon observed patterns in mining activity, it appears that local VC are responsible for the vast bulk of the mining activity. The members of a local force sapper cell seem to operate close to their home village, using their intimate knowledge of the surrounding terrain to hide themselves and their ordnance until the night they are ready to plant more mines. Captured enemy documents indicate that authority to emplace mines and boobytraps is decentralized to district level.

h. The Viet Cong employ both mines and boobytraps extensively. A good indication of the emphasis given to each type weapon is an analysis of 817 mine warfare incidents in Vietnam between 1 March 1968 and 10 June 1968. The results of this

analysis are given in table 5-1, and indicate that mines are encountered on a greater scale than boobytraps on a countrywide basis.

Table 5-1. Mine Warfare Incidents VN March-June 1968

Incidents	Number	Percent
Mines	511	62.5
Boobytraps	306	37.5
Total	817	100.0

i. The data in table 5-2 indicate the relative effectiveness of detection methods with respect to the mine warfare incidents discussed above. Notice particularly that 45.8 percent of the mines and 51.1 percent of the reported boobytraps were detected by detonation. This is a clear indication of the effectiveness of enemy techniques and the need for thorough training of individuals in detection methods as well as command and organizational procedures (SOP's) for countermine operations in small units.

Table 5-2. Detection of Viet Cong Mines and Boobytraps, March-June 1968

Method	Mines		Boobytraps	
	Number	Percent	Number	Percent
Detonation	234	45.8	157	51.3
Visual	139	27.2	125	40.9
Civilian informers	3	0.6	1	.3
PRS-4	26	5.1	3	1.0
PRS-3, 153	65	12.7	9	2.9
Probs	30	5.9	1	0.3
Other	14	2.7	10	3.3
Total	511	100	306	100

j. Although there have been indications that the Viet Cong prefer to employ command-detonated mines, a majority (56.5 percent) are still activated by simple pressure devices. The trip wire,

with 47.1 percent of incidents, remains the most common boobytrap activator as shown in table 5-3.

Table 5-3. Type of Firing Device March-June 1968

Type	Mines		Boobytraps	
	Number	Percent	Number	Percent
Pressure	289	56.5	36	11.8
Pressure release	9	1.8	15	4.9
Pull	2	0.4	28	9.2
Pull release	4	0.8	27	8.8
Command electric	45	8.8	8	2.6
Command pull	6	1.2	4	1.3
Pressure electric	77	15.1	5	1.6
Tripwire	4	0.8	144	47.1
Other	14	2.7	8	2.6
Unknown	61	11.9	31	10.1
Total	511	100	306	100

k. Types of explosive are shown in table 5-4. Despite the variety of available explosives, the grenade is shown to be the favored type for boobytraps. Grenades were used in 71.3 percent of the incidents. Manufactured mines are the preferred

form of explosive for mines—as might be expected. In both cases, the comparative reliability and simplicity of standard military equipment is used more often than the highly publicized “ingenious” improvisations.

Table 5-4. Type of Explosives March-June 1968

Type	Mines		Boobytraps	
	Number	Percent	Number	Percent
Mine	320	62.6	5	1.6
Claymore	18	5.5	5	1.6
Grenade	3	0.6	218	71.3
Arty/Mortar	29	5.7	36	11.8
Bomb	5	1.0	1	0.3
TNT	54	12.5	1	0.3
Other	18	3.5	13	4.2
Unknown	44	8.6	27	8.9
Total	511	100.0	306	100.0

l. Tables 5-5 and 5-6 indicate the country of manufacture and the size of charge respectively. The enemy philosophy is to use locally available materials for production of mines and boobytraps. A major share of such materials is of U.S. origin and acquired by pilferage of US and RVN supply points and by recovery of munitions and materials

discarded or abandoned by troops in the field. Note that the most frequent country of origin for boobytraps is the United States. Such statistics emphasize the importance of unit supply discipline and security measures for protection of munition stocks.

Table 5-5. Country of Manufacture, March-June 1968

Origin	Mines		Boobytraps	
	Number	Percent	Number	Percent
U. S.	82	16.1	120	39.2
USSR	9	1.8	0	0
CHICOM	103	20.1	80	26.2
VC Local	146	28.6	23	7.5
Other	38	7.4	8	2.6
Unknown	133	26.0	75	24.5
Total	511	100.0	306	100.0

Table 5-6. Size of Charge March-June 1968

Size Pounds	Mines		Boobytraps	
	Number	Percent	Number	Percent
0-10	147	28.9	274	89.6
11-20	172	33.8	18	5.8
21-40	157	30.2	6	2.0
Over 40	28	5.7	5	1.6
Unknown	7	1.4	3	1.0
Total	511	100.0	306	100.0

m. Additional statistical information of Viet Cong mine activities is shown in tables 5-7, 5-8, and 5-9. The data in these tables are of the type provided by an effective reporting system from the field as discussed in paragraph 6-8 "Reporting." Analysis and evaluation of the data indicate that pressure fuzes are a preponderant type of activator used by the VC. Use of electrical type activators, however, is fairly high, indicating good reason for rendering batteries completely useless before discarding. Data evaluation also indicates that a major share of materials used are of U.S. origin and are less than 20 pounds, providing additional emphasis for protecting easily pilfered or discarded munition stocks.

5-2. Employment of Antivehicular Mines. Enemy placement of mines varies depending on the type of road or trail. Two major types are dirt or paved surfaces.

a. One method of mining dirt roads is to dig up one or more sections of the road and leave. After friendly forces fill in the dug up sections of road, the Viet Cong return and mine the filled-in sections. The Viet Cong may dig many holes in a dirt road but only mine a few of them. In addition, metal fragments and objects often are buried in the repaired holes, craters or trenches to further confuse minesweeping efforts. With all of the filled-in holes appearing to be mined, friendly

Table 5-7. Mine Incidents - Types of Explosive Firing Device.

	Mine		Claymore		Grenade		Arty Mortar		Bomb		TNT		Other		Unknown	
	No	%	No	%	No	%	No	%	No	%	No	%	No	%	No	%
Pressure	217	67.8	2	7.1	1	33.3	17	58.7	5	100	23	35.9	8	44.4	16	36.4
Press Rel	7	2.2	0		0		0		0		1	1.6	1	5.6	0	
Pull	0		1	3.6	0		0		0		0		1	5.6	0	
Pull Rel	2	.6	0		1	33.3	0		0		0		0		1	2.3
Cmd Elect	11	3.4	15	53.6	0		6	20.8	0		9	14.1	2	11.1	2	4.5
Cmd Pull	5	1.6	0		0		1	3.4	0		0		0		0	
Press Elect	36	11.3	6	21.4	0		3	10.3	0		23	35.9	2	11.1	7	15.9
Tripwire	2	.6	2	7.1	0		0		0		0		0		0	
Other	11	3.4	1	3.6	0		1	3.4	0		1	1.6	0		0	
Unknown	29	9.1	1	3.6	1	33.3	1	3.4	0		7	10.9	4	22.2	18	40.9
Total	320	100.0	28	100.0	3	99.9	29	100.0	5	100.0	64	100.0	18	100.0	44	100.0

Table 5-8. Origin of B<sub>1</sub> bytraps by Size of Charge and Type of Explosive.

	Origin of boobytraps by size of charge											
	US		USSR		CHICOM		VC local		Other		Unknown	
	No	%	No	%	No	%	No	%	No	%	No	%
0-10 lb	104	86.7	0		79	98.7	23	100.0	1	12.5	67	89.4
11-20 lb	7	5.8	0		0		0		6	75.0	5	6.7
21-40 lb	3	2.5	0		1	1.3	0		1	12.5	1	1.3
Over 40 lb	4	3.3	0		0		0		0		1	1.3
Unknown:	2	1.7	0		0		0		0		1	1.3
Total	120	100.0	0		80	100.0	23	100.0	8	100.0	75	100.0

Origin of boobytraps by type of explosive

	Origin of boobytraps by type of explosive											
	US		USSR		CHICOM		VC local		Other		Unknown	
	No	%	No	%	No	%	No	%	No	%	No	%
Mine	0		0		0		1	4.3	0		4	5.3
Claymore	2	1.7	0		2	2.5	0		0		1	1.3
Grenade	84	70.0	0		74	92.4	15	65.4	0		46	61.3
Arty/Mortar	26	21.7	0		3	3.8	1	4.3	0		5	6.7
Bomb	1	.8	0		0		0		0		0	
TNT	0		0		0		0		0		2	2.7
Other	7	5.8	0		1	1.3	3	13.0	2	25.0	0	
Unknown	0		0		0		3	13.0	6	75.0	17	22.7
Total	120	100.0	0		80	100.0	23	100.0	8	100.0	75	100.0



Table 5-9. Origin of Mine by Size of Charge and Type of Explosive.

Origin of mines by size of charge

	US		USSR		CHICOM		VC local		Other		Unknown	
	No	%	No	%	No	%	No	%	No	%	No	%
0-10 lb	40	48.8	2	22.2	18	17.5	36	24.7	9	23.7	42	31.6
11-20 lb	23	28.0	5	55.6	38	36.9	42	28.8	17	44.8	47	35.3
21-40 lb	16	19.6	2	22.2	41	39.8	62	42.4	10	26.3	26	19.6
Over 40 lb	2	2.4	0	0	6	5.8	5	3.4	1	2.6	14	10.5
Unknown	1	1.2	0	0	0	0	1	.7	1	2.6	4	3.0
<b>Total</b>	<b>82</b>	<b>100.0</b>	<b>9</b>	<b>100.0</b>	<b>103</b>	<b>100.0</b>	<b>146</b>	<b>100.0</b>	<b>38</b>	<b>100.0</b>	<b>133</b>	<b>100.0</b>

Origin of mines by type of explosive

	US		USSR		CHICOM		VC local		Other		Unknown	
	No	%	No	%	No	%	No	%	No	%	No	%
Mine	44	53.6	8	88.9	65	63.1	93	63.7	26	68.5	86	64.7
Claymore	3	3.7	0	0	20	19.3	0	0	0	0	5	3.8
Grenade	1	1.2	0	0	0	0	0	0	0	0	2	1.5
Arty/Mortar	24	29.3	0	0	1	1.0	0	0	0	0	4	3.0
Bomb	6	7.3	0	0	1	1.0	0	0	0	0	0	0
TNT	1	1.2	0	0	11	10.7	37	25.3	1	2.6	14	10.5
Other	3	3.7	1	11.1	4	3.9	7	4.8	1	2.6	2	1.5
Unknown	0	0	0	0	1	1.0	9	6.2	10	26.3	20	15.0
<b>Total</b>	<b>82</b>	<b>100.0</b>	<b>9</b>	<b>100.0</b>	<b>103</b>	<b>100.0</b>	<b>146</b>	<b>100.0</b>	<b>38</b>	<b>100.0</b>	<b>133</b>	<b>100.0</b>

forces must investigate each one, resulting in further delay.

b. A variation of this technique is to bury many randomly spaced groups of metal fragments in the road. This requires extensive probe operations and tends to promote complacency in mine sweeping teams. At a later time, a mine is either buried under previously placed metal fragments or is inserted into the random pattern in anticipation that it will pass as fragments. See also figure 4-34 for another adaption of the basic technique.

c. In another related technique the Viet Cong dig holes at night on compacted roads and fill the holes with loose dirt. Sweep teams notice the loose earth but, on checking, find nothing. After the sweep team moves down the road, the Viet Cong quickly install a box mine in the hole. Sweep teams should carry a can of used oil to cover holes containing loose earth. If the earth is disturbed, it will be obvious to the sweep team on its return trip.

d. The enemy has displayed a tendency to use increasingly larger charges per weapon while reducing the amount of pressure required to initiate detonation. There is also a tendency to bury these larger charges deeper in the road, below the range of current detection equipment. Depths of two feet or more have been found. Explosives and other ingredients required for explosive device production are abundant enough to allow the enemy to increase the amounts of explosive in each charge. Even foreign manufactured items may have explosive added. The M1A1 and its variations are often boosted with 8 to 10 pounds of TNT and buried at a depth of approximately 2½ inches. This indicates an enemy desired to attack and destroy vehicles with the lightest ground pressure. To estimate the size of charge from the resultant crater of accidentally or deliberately destroyed mines see table 6-1, Crater Size Vs Charge Weight.

e. The most likely sites for employment of mines with a pressure firing system include road junctions, bypasses, wheel tracks, bridge approaches, rough or newly repaired roads, culverts, narrow roads between swamps or mountains, and embanked roads flanked by flooded ricefields. Although no set pattern of employment of mines at road junctions has evolved, it is not uncommon to find mines placed in the corners of the junction where a tank, APC or truck is likely to cut the corner frequently (fig. 5-1). Mines have been found 100 meters from the junction itself and off the road 5 to 20 meters. This pattern is probably

used to counter efforts to detect the detonation wiring apparatus.

f. While bridges themselves have been mined, more frequently the approaches are mined (fig. 5-2). Devices are often implanted on the road or shoulder 5 to 15 meters from the bridge itself.

g. Enemy training documents stress the use of wet roadways as mine sites during the rainy season. The mine is enclosed in water-impervious material and placed in mud holes with little other preparation. In many mud puddles, the mines were placed at a depth greater than 36 inches. In such soft soil the mine may be supported by boards to insure that the mine does not sink. A variation is to cover the mine location with buffalo dung, particularly if the area is characterized by cattle frequently crossing the roadway. Such tech-

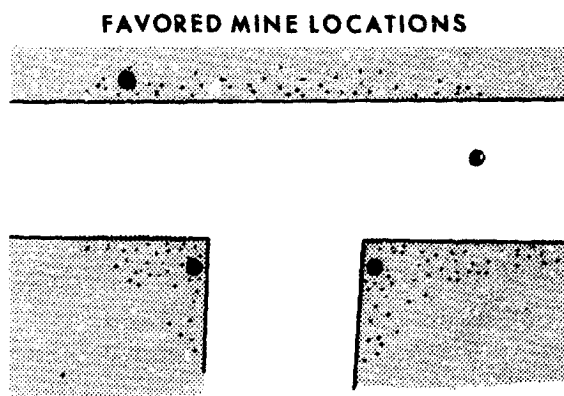

Figure 5-1. Emplacement of AT mines at road junctions.

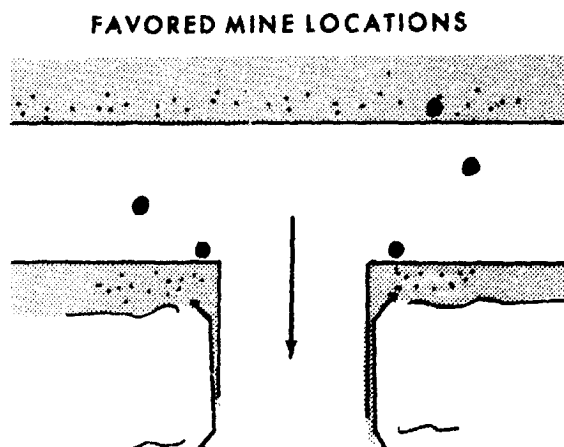

Figure 5-2. Emplacement of mines on bridge approaches.

niques capitalize on a natural American dislike for dirt and mud.

*h.* The Viet Cong have displayed a tendency to mine the wheel tracks, ruts or depressions made by traffic on dirt roads. Another tendency, often used in conjunction with the above, is to employ pressure-electric road mines with the explosive offset from the actuating device so that the explosion occurs under the belly of the vehicle. These techniques make bypasses favorite mining sites of the Viet Cong.

*i.* Hoping to confuse an inexperienced mine detector operator, the Viet Cong like to place mines above metal culverts (fig. 5-3). An unskilled operator tends to disregard a metallic return above a culvert because he assumes it is the culvert he has detected. The proper method of detecting a mine above a metal culvert is to adjust the sensitivity of the mine detector until it picks up the culvert. Then reduce the sensitivity gradually until the culvert is no longer detected and sweep the area over the culvert. By properly adjusting the sensitivity of the mine detector in the above manner, only those metallic objects above the culvert will be detected. This technique is difficult and extra caution and alertness are required in the vicinity of metal culverts. Minesweep personnel should search the inside of the culvert and the area outside both ends of the culvert for wires or freshly dug holes.

*j.* In the delta the Viet Cong have begun placing an inch or more of rice over anti-tank mines. This has absolutely no effect on the P/153 mine detector but does contribute to the concealment of the mine. Soil backfilled over a mine will settle with time and, often, this leads to visual detection of the depression and discovery of the mine. How-

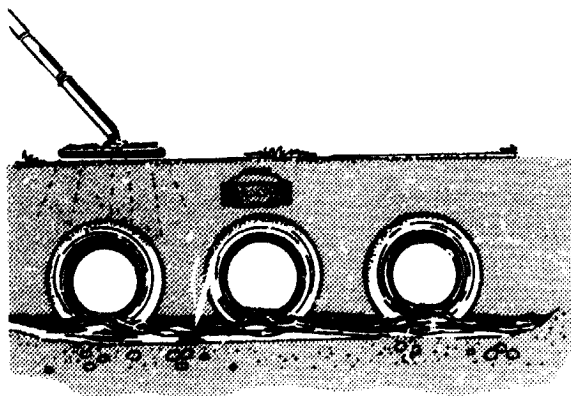

Figure 5-3. Mines emplaced above culverts.

ever, the rice absorbs moisture and swells, thus countering the soil settlement, and making the area more difficult to detect visually. As an alternative, the dirt fill may be placed to a level approximately 1 inch (2 centimeters) above the road surface over the mine. This is done primarily in the rainy season to offset the rapid settlement.

*k.* In extremely hostile areas, it has been found that the Viet Cong have prechambered sections of the road. They leave the chambers empty, place a board or other non-metallic substance over the top, and backfill to the road level to disguise its existence. The minesweep team often passes over the empty chambers on its sweep up the road. After the convoy has passed, the Viet Cong return and quickly place a mine device in the chamber and backfill again. Vehicles returning as little as 3 hours later have been destroyed in this manner. Sweeping the road on a return trip is essential to deter mining after a convoy or task force has passed. In addition, the placing of security elements along the road or combinations of strong-points and patrolling have eliminated this type of mining incident. Helicopter observation of the road at low level is also a deterrent against such activity.

*l.* Enemy attempts to destroy road construction equipment by antivehicular mines are being counteracted by aggressive minesweeping of shoulders, ditches, and tops of back slopes in the construction area, especially after a rainy night. On routes 14N and 512, where mining was active, a construction unit often found one to six mines within a 200-meter radius of the first mine detected. Mines have been found in ditches and on the back slopes of ditches and cuts some distance off the roads, indicating the intent to destroy engineer equipment working off the road in adjacent areas.

*m.* The Viet Cong make use of dud, captured or discarded allied munitions, to include artillery ammunition, mortar ammunition, bombs and locally manufactured items. For instance, 105mm rounds have been simply buried in the ground at a depth of approximately 3 inches and electrically or pressure detonated. One particular configuration used an M14 AP mine buried slightly under the road surface. Under the mine was a 20 pound block of TNT and under that a 105mm round. As with 105mm rounds, 155mm rounds are a common explosive device. A number of configurations have utilized an M14 AP mine buried approximately 3 inches under the road surface. A section of detonating cord buried 18 to 22 inches underground

connected the antipersonnel mine with a cluster of 155mm and 105mm rounds. This particular configuration is less susceptible to mine detection efforts, as the bulk of the explosive and metallic parts are buried at a greater depth. Mortar shells are most often found buried in a roadway or in a road shoulder with the nose pointing upward and pressure actuated. The actuator is usually buried 1 to 5 inches under the road surface.

n. Bombs are usually buried approximately 20 inches under the ground surface. They are most often actuated with a pressure device or detonated by an AP mine. The detonator is connected to the bomb by detonating cord or is boosted by a block of TNT. Unexploded allied ordinance provided the bulk of the explosive used in locally manufactured mines. Heavier bombs are cut; TNT filler is extracted and used in various explosive devices. Most common is a block of cast TNT, usually about 20 to 40 pounds in weight with an indentation for a detonator. The Air Force BLU-3B (pressure actuated) bomb is used to activate such mines.

o. Employment of mines on hard surfaced roads presents emplacement problems which are not found in dirt roads. This does not deter the Viet Cong from effectively mining paved roads and eliminating most evidence of mining activity. One technique is to smear the road with mud in many places day after day but place no mines. After familiarity with the condition has been established, the Viet Cong will lay mines in some mud-smear sections. Another technique is to remove an asphalt patch and place one or more mines; the hole is then resurfaced with a piece of asphalt which has been removed intact from the road surface. The asphalt is repositioned and sand is poured into the cracks. If the asphalt section crumbles, then a piece of board or bamboo wicker covered with loose asphalt is substituted. Often tire or skid marks are created across the patch to blend it into the rest of the road. Hastily emplaced mines may be covered with straw, grass, dung or other substances likely to be found in the road.

p. A technique commonly employed by the Viet Cong to mine paved roads is to tunnel under the road from the shoulders. Many roads in Vietnam are constructed on fill, particularly in rice country, and the shoulders are well suited to horizontal excavation. For under-road mining, the Viet Cong often utilize large demolition charges, artillery shells, or even bombs, rather than standard land mines. Initiation is by an electrical command

firing system. With the road surface undisturbed and electric wires buried, this method of mining is difficult to detect unless there is careful reconnaissance on the shoulders of the road. The large crater created as a result of the increased explosive content also provides an effective road obstruction.

q. Fixed directional mines appear to be increasingly favored items of hardware for employment against traffic on paved roads. Fired from a camouflaged position on the shoulder, their devastating fragmentation effects are especially effective against trucks or jeeps carrying troops. They are also effectively used in built-up or urban areas where they can be an especially effective terrorist or ambush weapon.

r. One practice which has been widely adopted for the protection of both mines and boobytraps is to attempt to waterproof the device by wrapping it in sheet plastic, waterproof canvas or other waterproof material. This helps increase the reliability of the mine in the wet season of Vietnam.

s. Regardless of the method employed or the type of road being mined, the Viet Cong rely on hurried or careless mine detecting by U.S. forces. A road found to be clear of mines in the morning may well be mined in the afternoon, or clear one day and mined the next. In digging holes or smearing mud on roads and not mining for some period of time, the Viet Cong rely on U.S. troops becoming confident that the road is not mined and neglecting to check every location day after day. Hasty or careless mine reconnaissance by the opposing force is a distinct element of Viet Cong mine warfare doctrine.

t. In terms of road mining, the one generalization that can be made is that Viet Cong tend to mine the same sectors of roads on a repetitive basis. This may be due to the VC living within easy access of a given road section or to the proximity of cover to the road. The VC also favor curves, upgrades and cut areas, perhaps a hold-over from the time when they used mines to trigger ambushes. This is an aid to sweep teams in that they develop an ability to sense the most dangerous portion of the roads.

**5-3. Employment of Antipersonnel Mines** a. Although antitank mines present a hazard to vehicles on roads and trails, antipersonnel mines present an even greater hazard to foot troops in Vietnam. In spite of increased use of vehicular and air movement of troops and supplies, the vast

majority of military operations are conducted on foot. The nature of the terrain and the tactics of the war provide almost unlimited techniques for employing antipersonnel mines.

b. There are two basic types of antipersonnel mines, fragmentation and blast. The fragmentation mine depends on its ability to cover a fairly wide area with high velocity fragments while the blast type antipersonnel mine depends on the direct force developed by its explosion. Further, there are three types of fragmentation mines, bounding, fixed nondirectional and fixed directional. In a large portion of Vietnam, antipersonnel mines are usually employed above ground or slightly underground and rigged with a tripwire firing system.

c. As a general rule, the Viet Cong can be expected to employ antipersonnel mines anywhere that troops might walk. No area can be assumed to be clear simply because it had been clear at some previous time. Some of the more likely places of employment are: along trails, in high grass, in front of defensive positions, in and around likely helicopter landing sites, near shaded areas where troops may congregate, at bridges and fording sites over streams and drainage ditches, on rice paddy dikes, along roads at ambush sites, in what appears to be the easy way through dense vegetation, in the vicinity of cave and tunnel entrances, in and around villages, in hedgerows and tree lines, in likely CP and bivouac sites, where tree branches overhang roads and trails, and on fence lines and gates.

d. The Viet Cong use tripwires extensively, particularly across trails and in dense vegetation. The wires are usually stretched 3 to 5 inches above the ground. Many improvised mines, including artillery and mortar shells, are initiated by electrical command detonating systems in the same manner as antitank or antivehicular mines. The Viet Cong utilize all types of material for tripwires. U.S. tripwire is used extensively and is difficult to detect in the dense undergrowth. Even more effective, and more extensively used, is a monofilament fishing line type of wire. When these two types of wires are in short supply, the Viet Cong make use of any available material. U.S. communications wire has been used as tripwire as well as for electrical command firing wire. When cutting communications wire, care must be taken to insure that it is not an electrical installation; cutting both wires simultaneously may detonate the charge. Other materials used by the Viet Cong are 1/4-inch fiber

rope and strips of bamboo and vines. Viet Cong tripwires are skillfully installed and require a sharp eye to detect. Sunglasses are a dangerous detriment to detecting tripwires.

e. A favorite tactic of the Viet Cong is the ambush, and both antitank and antipersonnel mines are used effectively for this purpose. Antitank mines are used to trigger an ambush by stopping or disrupting a convoy. As troops deploy off the road to attack the ambush force, antipersonnel mines are initiated, adding further confusion to an already tense and difficult situation. Both tripwire and command initiated mines are used; however, as in most Viet Cong mining activities, large numbers of mines are not employed. Placement of a few mines is carefully planned to supplement an equally well-planned ambush, and the intended result may be achieved with minimum expenditure of materials and effort.

f. One antipersonnel mine which appears to be gaining increased use against friendly troops is the Claymore type mine and the many enemy variations of this device. This type will produce casualties at a distance of 200 meters among personnel without some kind of protection such as body armor. It is usually placed on flat ground with an unobstructed field of vision to the target area. The mine is frequently positioned against a wall, a tree, or some other obstruction. In over 50% of reported cases it was command detonated by electrical means. The detonation wires are buried deeply under firm packed earth. In addition, enemy training documents suggest husking garlic and placing it underground with the wire, on the trench concealing the wire, and around the firer's location to prevent discovery by scout dogs. One enemy variation of the Claymore, the DH 10, when used in a group of three, is capable of cutting a path through barbed wire 2 meters wide and 30 to 40 meters long. These mines have been used with devastating effects when suspended from a tree limb or other elevated objects. When employed in trees, they have been used primarily against troops riding atop tanks or APC's.

5-4. **Employment of Boobytraps.** As mentioned in the start of this section, approximately 38% of all mine warfare incidents in a given period were classified as boobytraps. Viet Cong boobytraps include both explosive and nonexplosive devices, and the extent to which either is employed is limited only by inventive skills and materials available. Boobytraps can have a psychological effect much

greater than the weight of numbers would indicate. Employed discriminately in many carefully selected applications, they demand constant attention and alertness on the part of the individual soldier. They can create a state of apprehension and fear in the inexperienced and untrained soldier which is both debilitating and demoralizing. A major trend in the use of boobytraps has developed. The Viet Cong are concentrating on *explosive* boobytraps and essentially curtailing the use of nonexplosive boobytraps. The reasons for this include the increased likelihood of multiple casualties in explosive boobytraps, and the unrewarding and extensive effort required to install and maintain nonexplosive boobytraps. Boobytraps are likely to be found in the same areas where antipersonnel mines are characteristically employed.

*a. Employment of Explosive Boobytraps.* The Viet Cong employ explosive boobytraps in all phases of their operations. Simplicity and ingenuity best describe VC techniques and account for the high incidence of boobytrapping. Any opportunity is exploited to trap the unwary, inexperienced, and even careless opponent. Specific explosive boobytraps were discussed in section IV of this circular; further generalization of methods and techniques follows.

(1) The simplest form of boobytrapping employed by the Viet Cong is either a pull or pressure release device attached to an antitank mine or other charge used as a mine. This technique is no different than U.S. doctrine of placing anti-handling devices in antitank mines, and U.S. personnel should be thoroughly familiar with detecting and overcoming such devices.

(2) The explosive charges used in boobytrapping are generally the same as those used in mines. Standard antitank and antipersonnel mines, hand grenades, mortar and artillery projectiles, and miscellaneous improvised explosive charges are all utilized in boobytraps.

(3) Except for special applications, such as terrorist activities, the fuzes and firing devices used in boobytraps are similar to those used in mines. Boobytraps and other explosives used in terrorist activities often utilize more sophisticated firing systems; for example, the mousetrap and wristwatch firing devices, the electrical system in the bicycle mine, and the cigarette lighter and fountain pen devices.

(4) Any installation which the Viet Cong may have occupied can be expected to be mined and boobytrapped to some degree. Buildings of all types offer unlimited opportunities for explosive

boobytraps—entrances, furniture, windows, floorboards, and miscellaneous items found in buildings.

(5) Areas in and around villages are often boobytrapped by the Viet Cong when they withdraw. Gates, fences and hedges, trails and paths, shrines, wells, dead bodies, and abandoned supplies and equipment have all been boobytrapped by the VC.

(6) Supply areas from which the Viet Cong have been forced to withdraw are almost certain to be boobytrapped. Weapons, ammunition, clothing, and food supplies must be approached with caution.

(7) Occasionally the Viet Cong will employ dummy boobytraps along with live ones. Here again, the VC rely on U.S. troops becoming careless in their reconnaissance and detection activities.

(8) In addition to placing antipersonnel mines in the vicinity of cave and tunnel complexes, the entrances themselves are often boobytrapped. Hastily opening and entering these entrances can be fatal.

(9) The Viet Cong like to employ boobytraps or mines in pairs. Often the first explosion will concentrate personnel to help the wounded, etc. and provide a lucrative opportunity for the second, especially if it can be command detonated.

(10) The Viet Cong will mine or boobytrap a route or trail that a patrol has used to leave its base of operations. The Viet Cong thus hope to penalize a patrol that becomes careless moving back along a route that shortly before had been clear. Patrols or similar groups should not return along the same route by which they left their base.

*b. Employment of Nonexplosive Boobytraps.* Nonexplosive boobytraps have the same purpose as antipersonnel mines and explosive boobytraps: to inflict personnel casualties and hinder the progress of the troops. This form of boobytrap has been used much less recently in favor of explosive boobytraps. The individual traps were discussed in section IV of this circular, and the general techniques of construction and employment follow.

(1) Nearly all nonexplosive traps are improvised from locally available materials and take advantage of natural camouflage.

(2) Bamboo, which is readily available, is used in many traps. Poles, whips, pit frames and covers, punji stakes, and various other trap components are usually made of bamboo.

(3) Punji stakes are used extensively in traps, on revetments, or on stream and ditch banks to hinder assaulting troops. The placement of punji stakes is such that a man running, or jumping from one stream or ditch bank to another, will be impaled on the stakes.

(4) Nonexplosive traps are most often employed with mines or explosive boobytraps, and they may be used at ambush sites. In a Viet Cong defensive position, camp, or village, it would not be unusual to find together all of the tricks known to the Viet Cong: tunnels, anti-tank mines, anti-personnel mines, explosive boobytraps, and nonexplosive traps.

(5) As a general rule, mantraps, whether simple spike boards or deep pits, are located where an individual's attention is likely to be focused elsewhere. Careful reconnaissance of a trail for tripwires may cause an individual to overlook a well-camouflaged pit trap. While investigating a gate for a grenade trap, an individual may fall prey to any one of a number of spike or pit traps.

(6) In employing nonexplosive traps, the VC rely on U.S. personnel to be in a hurry, and as a result, careless. This is the same concept used in the employment of mines and other boobytraps, and it simply adds to the list of innovations and improvisations which are so common in Viet Cong doctrine.

**5-5. Employment of Water Mines.** The objectives of the enemy water mine effort include harassment and interdiction of both friendly patrol and support craft and friendly land and water supply routes by destroying bridges and surface craft. The methods of achieving this include attacks on moving surface craft, moored surface craft and bridges. To date most attacks on moving surface craft have employed electrically detonated, command fired bottom or moored mines. Attacks on moored surface craft and bridges have been made by swimmers placing time delay or command electrically detonated water mines. The major exception to the above generalization is the appearance of a variation of the Soviet 1000 pound MKB chemical horn contact mine. Representative types of water mines are discussed in paragraph 2-4.

a. One category of water mine is the moored bottom or floating mine.

(1) This mine is transported to the proposed target position and planted on the bottom or moored to an anchor of at least three times its weight. A float marker is attached which will ride

on the surface (preferably some small item peculiar to normal floating debris in the area for daytime detonation, or a clear receptacle containing fireflies or some other phosphorescent material for night detonation). If a float marker is not used, a guiding stake might be placed on the opposite bank. If a float marker is used, the mine usually is detonated when the target is within 3 meters of the float. If no float marker is employed, then the mine will be detonated when the target passes between the detonating point and a known mark on the opposite bank.

(2) The detonating wire is led from the mine to the anchor (if it is a floating mine) and along the bottom to the firing position. The wire is usually weighted every 2 or 3 meters to keep it on the bottom. Various methods of weighting the detonating wire have been used, not only to weight the wire, but also to counter chaindrag mine-sweeping operations by friendly forces. Recently captured documents indicate that the detonating wire may be buried in mud by underwater swimmers where time and bottom conditions permit. Firing mechanisms consist of electric blasting caps inserted into a booster or the main charge. The electric wire is led from a battery pack or hand-held generator. When available, an ohmmeter will be used to test the firing circuit after the mine has been planted, and each time a minesweeper passes. Captured VC training documents contain instructions on how to determine size and number of batteries required for given lengths of detonating wire and various series and parallel detonator circuits.

(3) Where the depth of the water remains at a level of from 2 to 3 meters, a bottom mine may be used; however, the normal situation requires the use of a moored floating mine. When the range of the tide or the draft of the target ships dictates changing the depth of the mine, two courses are open to the sappers: first, send out a swimmer to adjust the mine as necessary; second, at the outset, rig a "mobile" mine. The mine is made vertically mobile by running the anchor line from the mine, through a fair-lead or pulley on the anchor, and then to the bank. Then by pulling or slackening this line from the bank, the mine will be lowered or raised. This type of mine is especially susceptible to chaindrag minesweeping.

(4) When, because of the extreme width of the waterway, it is considered desirable to move the mine laterally in order to detonate it successfully under a target, the following technique may be employed. An anchoring stake is driven into the

bank beneath the waterline on both sides of the waterway. A heavy line is stretched taut below the water surface between two stakes, and the wire is suspended beneath the line by means of a pulley which rides freely over the line. By using a guy line from the mine to a man on each bank, the mine may be traversed over the width of the waterway. This, and any similar setup, is particularly vulnerable to chaindrag minesweeping.

(5) A recent series of successful minings on the Cua Viet River in Quang Tri Province demonstrated the enemy's resourcefulness in countering minesweeping tactics. Initially, chaindrag sweeps were conducted morning and evening. After several successful mining attacks, it was apparent that the mines were laid after the minesweepers passed. Then, boats using the river were organized in convoys and transited the river with minesweepers stationed 1000 yards ahead of the convoy. Nevertheless, boats of the convoy were successfully mined in mid-channel, indicating that the mines were again laid after the minesweeper had passed, possibly by the use of sampans. Several sampans were observed crossing and otherwise using the channel between the minesweepers and the convoy. The convoys were then organized so that the minesweepers worked immediately ahead of the convoy. One convoy successfully passed. The next convoy had its minesweepers mined and ambushed close to the river banks. This series of minings is an excellent example of the resourcefulness of the Viet Cong and the use of channel restriction to their own advantage.

b. The second major category of water mines is the command or time-delay fired mines. Command- or time-delay fired mines, used against anchored ships, are usually emplaced by a three-man team. The mine is transported downstream and attached by a line with hook to the anchor chain of the target vessel. The length of the line is such that, when the mine floats down with the current, it will be stopped at a point alongside or under the engine compartment. The mines are generally buoyed by means of pneumatic rubber tubes of a quantity sufficient to maintain the desired depth.

(1) Where the mine is to be fired by a timing device, the above action completes the emplacement. If it is to be command fired, then the swimmers will string the firing wire from the mine and detonate as soon as they are clear of the ship and in a safe position. The command wire is then reeled in and the sappers withdraw.

(2) Where there is heavy sampan traffic in the vicinity of the anchorage, the mine may be

transported to the target by boat. This is accomplished by slinging the mine under the keel of the boat and proceeding as close to the anchor chain of the target vessel as is necessary to attach the hook. After the hook is attached, the mine is cut free from the boat and allowed to float with the current to the desired position under the target.

(3) A third technique of mining an anchored ship is to attach the mine directly to the target. In a recent mining attempt, the weapon was attached to the side cleaner staging and a boat fender. The new limpet mine is excellent for such use with its antihandling device.

(4) Swimming sappers, who employ underwater swimming techniques with a snorkel and underwater demolitions, have been successful in bridge demolitions in RVN. After thorough reconnaissance of the bridge to be destroyed, the sapper swims underwater to the bridge, secures the charge to the pier or protective system, and detonates usually with a chemical delay fuze. Upon detonation the shockwave propels a spout of water upward with sufficient force to destroy the span overhead. Nearby piers may also be destroyed, but this is considered to be a secondary effect. A captured NVA field manual contains the formula  $C=30Kdr^2$  for the calculation of the amount of explosives, C, in kilograms needed to destroy a bridge in this manner. K is a resistance coefficient; d is the thickness of the bridge or breaching distance in meters, and r is the distance from the center of mass of the explosive to the top of the bridge in meters. The amount of explosive calculated with this formula is based upon detonation taking place at the water's surface. Submerging the explosive reduces the quantity necessary. The explosive is secured to the pier or the pier protective system only to prevent it from drifting downstream. At one major bridge two charges of 100 kilograms each were placed simultaneously by two swimmers at two locations, each tied to the nearest pier protective cage at a depth of approximately two meters and timed to detonate simultaneously. While pier protective cages prevent explosives from being placed directly on the pier, they do not prevent a swimmer from placing a charge at any other location beneath the bridge.

(5) The above techniques are representative, but by no means exclusive. Factors which can and do result in variations of techniques of employing mines include size of the mine, target location, security measures, time of day, weather, avenues of escape, and daring or temerity of the VC sappers.



c. Meticulous planning and detailed rehearsal precede the employment of a VC water mine. Because of the limited effective range of the command-detonated water mines used by the enemy against moored ships, the location of the mine is of paramount importance. The average mine must be detonated within 3 to 5 meters of the target in order to achieve satisfactory results. For this reason the VC are limited to planting their mines in areas where they can assure the target's passing in close proximity to the mine. Preparation for a water mining may begin months prior to the attack. Careful studies are made of traffic patterns of possible targets, plus times and frequency of friendly US/VNN patrols and mine-sweeping operations in the chosen target area. Ideal mining sites are in restrictions or bends in waterways that tend to channel traffic over definite routes. Areas with natural and manmade obstructions are also suitable. In short, any phenomenon which funnels watercraft over a narrow path provides the enemy sapper with a good chance for success. The time and depths of low and high tide must also be studied in order that the mine may be placed in a depth suitable for destruction, yet not so high as to be detected from the surface. A wide range in tide will necessitate the use of a vertically mobile mine. In addition, the sappers are concerned with the terrain in the vicinity of the mining site. Heavy foliage on the banks is desired for concealment of the sampan to transport and/or lay the mine, the command detonating post, lookout stations up and down stream, escape routes, and positions of fire teams if ambush is planned to coincide with the mining.

d. VC sympathizers in the area are sometimes used to provide some of the intelligence required, as well as to assist in the work and after-action evasion. After the reconnaissance and preparation are completed, the actual placing and detonating of the mine is accomplished as quickly as possible. Captured VC documents state that the sappers are capable of planting 50-kilogram command water mines in about 10 minutes. Thus, it would seem that the ideal tactic is to wait until just prior to the arrival before laying the mine. This allows little or no time for minesweeping.

e. Tactics used against moored ships and rivercraft are dependent upon several factors.

(1) Location of the target to include its proximity to other anchored ships and whether it is moored to a pier.

(2) Speed of the current.

(3) Junk or sampan traffic.

(4) Security measures such as a lighted waterline, guards or detonation of antiswimmer concussion grenades.

f. If a target vessel is loosely guarded, darkened, and fairly isolated, it is a relatively simple matter for a VC sapper cell of two or three men swimming on or just under the surface (using breathing tubes) to transport a buoyant mine to the target and return to the detonating position for firing. If there are other junks or sampans about the vicinity of the target vessel, then the mine may be transported part way or entirely by boat. If concussion grenades are being dropped at regular intervals, then the sappers may take a chance and go in between grenades. Another tactic used by swimmer/sappers is to mine an empty berth before the target arrives. Then, after the ship is moored, the mine is detonated. This was done successfully at a US LST ramp in 1967; however, it has not been determined whether the mine was command- or time-detonated.

g. Tactics as well as techniques will change according to the equipment being used and the men employing the equipment. Viet Cong swimmer/sapper schools are known to exist in South Vietnam. Training of underwater sappers is also conducted at schools in North Vietnam. These schools train the sapper in all forms of underwater demolition. The duration of the course is two years and the classes range from 200 to 500 students. The course includes training in the following subjects: swimming (6 months); underwater swimming (8 months); demolition techniques (6 months), and practical exercises (4 months). Also, NVA cadre have an in-country training course for local VC to train them in underwater demolitions. The course is conducted in South Vietnam and is 8 months in duration. Physical evidence has been found of the introduction into enemy equipment stores of self-contained breathing apparatus. There have been indications of the use of sophisticated limpet mines by the enemy, greatly increasing the water mine threat to anchored ship.

**5-6. Employment of Mines Against Helicopters.** Enemy mine activities against heliborne operations and helicopters are largely confined to potential landing zones. Obstacles and mines are used by the enemy to restrict potential landing zones to those where he has an advantage to defend. This does not mean, however, that the enemy would not employ obstacles on landing zones that they have

decided to defend. Some techniques used by the enemy against helicopters follow.

a. Grenades with pulled safety pins wrapped in paper are placed in the landing zone. As the helicopter lands, the propwash forces the paper into the air, releasing the pressure on the safety lever and setting the grenades off. In a variation of this technique, pieces of sheet metal are placed in the landing zone. The propwash from the landing helicopter presses the sheet metal down, exploding mines placed beneath it.

b. Hardwood or bamboo stakes 4 to 20 feet high are placed in the landing zone. The poles pierce the skin of the helicopters and sometimes disable them. Punji stakes are also placed in landing zones to obstruct helicopters and their disembarking troops.

c. Communications wire is strung across the landing zone. This is very difficult for the pilots to see and is capable of downing helicopters. In addition grenades may be rigged from the communications wire in such a way that they are activated by the movement of the wire as the helicopter strikes it. See also the helicopter can trap, figure 4-39.

d. Captured U.S. 3.5 inch rockets have been placed on improvised firing tubes and set off by an electric firing device. In addition the array of DH mines (fragmentation mines) shown in figure 5-4 is used to saturate a landing zone with lethal fragments. See also the improvised grenade launcher, figure 4-38.

**5-7. Marking of Mines and Boobytraps by the Viet Cong.** Enemy doctrine stresses the control and reporting of the employment of mines and

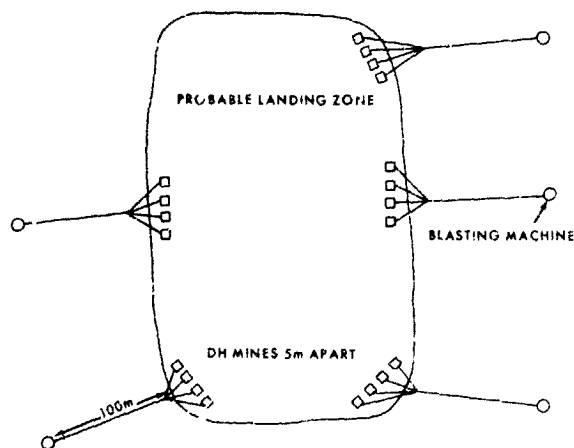

Figure 5-4. Fragmentation mines in landing zone.

boobytraps. All mines and boobytraps are not marked, and there seems to be little consistency in the methods and frequency of marking. There may be wide variance countrywide or even within a particular sector; however, it appears that the Viet Cong have some regard for the protection of their own people and villagers who are friendly and helpful to them. Much of the Viet Cong mine and boobytrap activity is in areas which they occupy and control, and, in order to have freedom of movement along roads and trails, they must know where mines and boobytraps are located. When U.S. forces quickly overpower a Viet Cong position, many markings are likely to be still in place. However, when time permits a reasonably orderly withdrawal, all or most markings will be removed. The methods of marking discussed in this paragraph have been identified with mines or boobytraps; however, methods will vary or change, and the meaning of a particular marking may never be clear. Although the Viet Cong utilize signs and markings for purposes other than mines and boobytraps, it is important to recognize and investigate markings which may indicate mine or boobytrap activity.

a. *Arrowheads.* Several methods of marking roads and trails have been identified, many of which make use of sticks or stones. Arrowheads (fig. 5-5) made of sticks placed on the road or trail indicate the presence of mines or boobytraps. The direction of the arrow does not always indi-

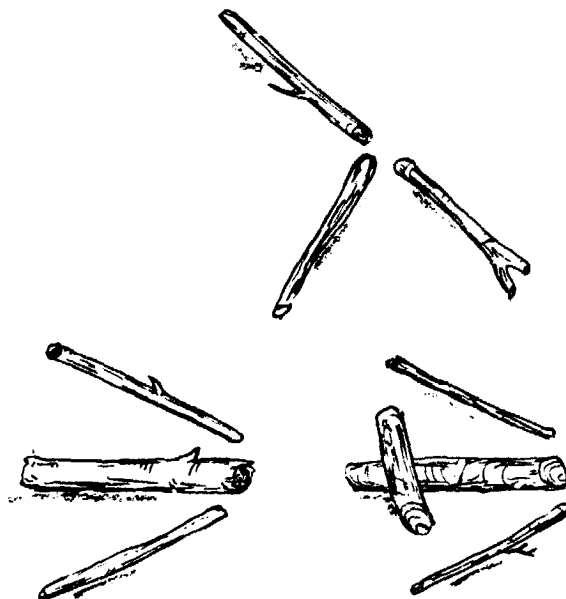

Figure 5-5. Arrow markers.

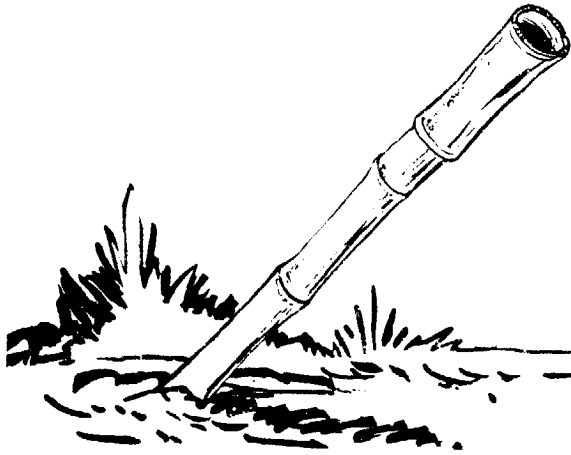

Figure 5-6. Bamboo marker.

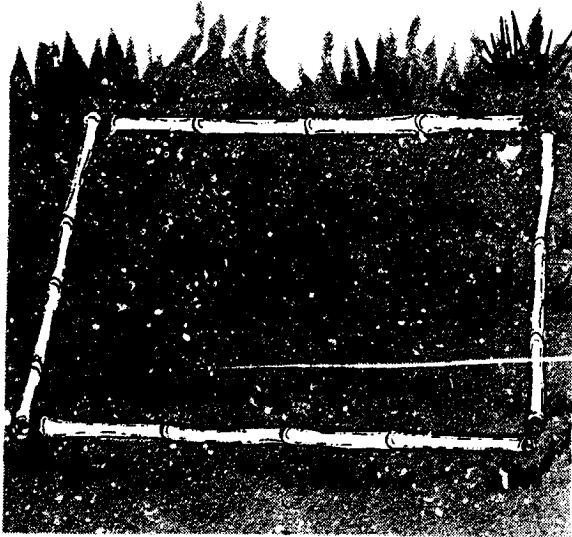

Figure 5-7. Bamboo rectangle marker.

cate the direction of the mine. A "Y" arrangement is sometimes used down the trail from the arrowhead to indicate the limit of the danger area. The distance from the markers to the danger area is not known.

*b. Bamboo Marker.* A piece of bamboo 6 to 8 inches long is covered on one end by a larger joint of bamboo (fig. 5-6). The bamboo is placed in the ground at about a 45° angle with the covered end pointing toward a mine or boobytrap.

*c. Bamboo or Grass Rectangle Marker.* A hand grenade antipersonnel mine was discovered inside

a rectangle consisting of four lengths of bamboo (fig. 5-7). The rectangle measured  $\frac{1}{2}$  meter by  $1\frac{1}{3}$  meters. A variation used tied bunches of grass at the corners of a 2-meter square to mark a mine or boobytrap.

*d. Bamboo Tripod Marker.* The bamboo tripod marker (fig. 5-8) consists of three 18-inch bamboo legs lashed together at one end to form a tripod. Wire or other material ties the bottom of the three legs a fixed distance apart to keep the device in its cone shape. The tripod marker is placed over punji pits, boobytraps, and mines.

*e. Broken Brush Marker.* The Viet Cong break the top of a small sapling and strip most of the branches from it. One branch is left on the sapling and points down the road or trail (fig. 5-9). Usually a mine or boobytrap is located 50 to 100 meters farther along the road or trail.

*f. Broken Stick or Bush Marker.* A stick or length of bamboo broken at a right angle and lying across a road or trail (fig. 5-10) may mean a

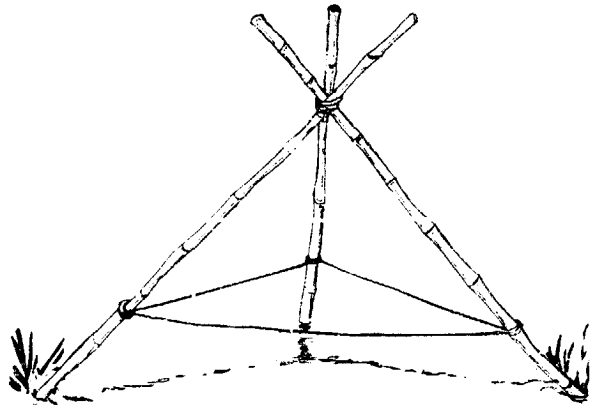

Figure 5-8. Bamboo tripod marker.



Figure 5-9. Broken brush marker.



Figure 5-10. Broken stick or bush marker.

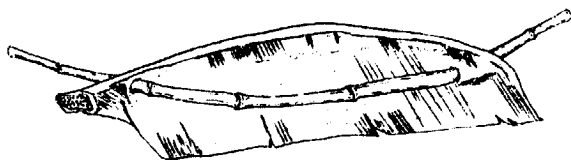
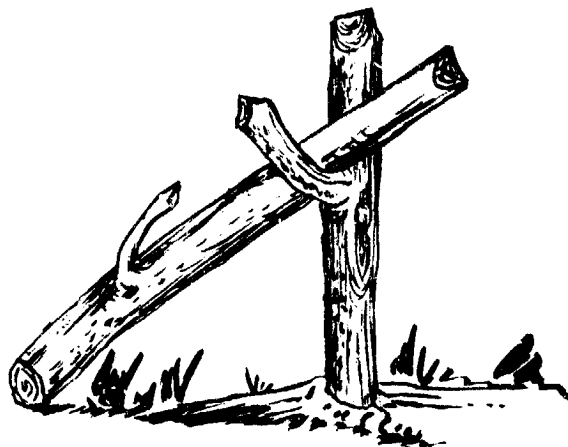

Figure 5-11. Folded leaf marker.

Viet Cong mine or boobytrap 200-400 meters ahead. A bush or small tree alongside the trail with the top broken and stripped of its leaves may indicate a mine or boobytrap ahead. A thorn vine is sometimes attached to the upper portion of the broken bush.

*g. Folded Leaf Marker.* A banana or similar leaf folded lengthwise in half with a thin stick approximately the thickness of a toothpick woven through the leaf in two places is used to mark mines (fig. 5-11). The device may also indicate an ambush area although the location and distance to the mine or ambush site is unknown.

*h. Forked Stick Marker.* A forked stick is driven vertically into the ground and another stick is then laid into the fork with the elevated end pointing to the danger area (fig. 5-12). Distance to the danger area is unknown. This sign may also be used by the Viet Cong to indicate direction of movement.



5-12. Forked stick marker.

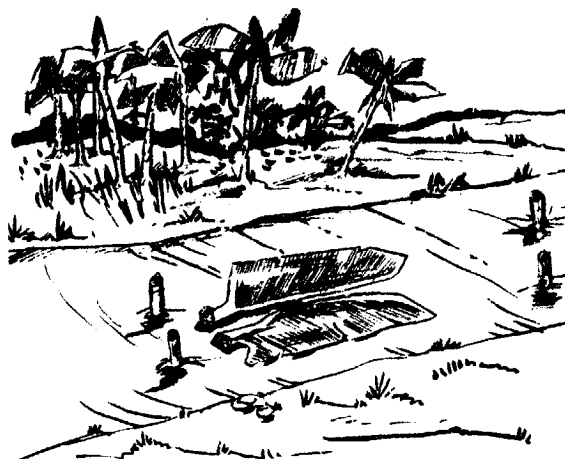

Figure 5-13. Trail mine or boobytrap markers.

*i. Trail Mine or Boobytrap Markers.* These two devices (fig. 5-13) were reportedly used in the same area. One mine/boobytrap marker consisted of two 10-inch leaves placed parallel to each other on top of the mine or boobytrap. The second device consisted of two short stakes placed on the trail, in front and to the rear of the mine or boobytrap. The distance from the stakes to the mine is unknown. These markers may be used individually or in conjunction with each other.

*j. Parallel Stick Marker.* Short sticks or lengths of bamboo laid parallel to a road or trail mean the trail is free of mines or boobytraps (fig. 5-14).

*k. Rock Markers on Trails.* Various formations of small rocks are placed on trails to serve as a warning of mines and boobytraps ahead (fig.

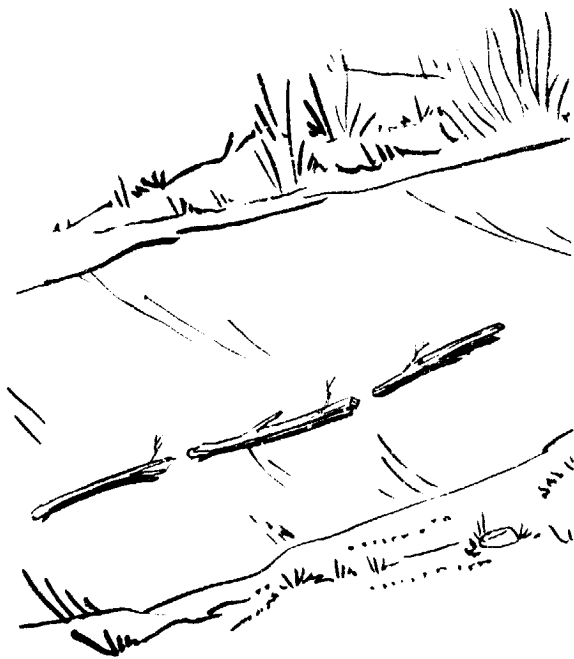

Figure 5-14. Parallel stick marker.

5-15). Rocks are placed in circular, pyramid, and straight line patterns. The distance from these markers to the mines is unknown. Another pattern used is a circle of rocks approximately 1 meter in diameter with a smaller circle of rocks inside of it. A small circle with a single rock in the center is also used. Mines or boobytraps are usually 150 to 200 meters farther along the trail or road.

*l. Spaced Stick or Stone Marker.* Three sticks or stones, one on each side of the road and one in the middle, usually mean the road is not to be used (fig. 5-16). A mine or boobytrap is usually 200 to 400 meters farther along the road.

*m. Vehicle Track Markers.* The Viet Cong capitalize on our habit of following old vehicle tracks by placing mines in these tracks. The mines are sometimes marked with crossed sticks or an arrangement of small rocks on the track in front of the mine (fig. 5-17). The location of the mine in relation to the markers is not consistent. The mine may be under the marker or up to 400 meters farther on.

*n. Stakes with "X" Marker.* An antitank mine with approximately 75 pounds of TNT was discovered under this marker (fig. 5-18). The mine had been marked with stakes at each corner and two sticks forming an X over the mine.

*o. Vine Markers.* An antipersonnel minefield

was discovered in a grassy area alongside a trail. The individual mines were marked with vine loops placed 6 inches from each mine (fig. 5-19). This device blends with the existing vegetation and is difficult to detect.

*p. Cloverleaf Device.* A cloverleaf-shaped device (fig. 5-20) constructed from bamboo reeds was found on a trail leading to a mined road intersection. The ends of the bamboo stems were pointing in the general direction of the mine location approximately 10 meters in front of the suspected mine markers.

*q. Palm Leaf Patterns.* A series of bent palms forming a uniform pattern has been found to mark boobytraps (fig. 5-21). The pattern is formed surrounding the boobytrapped area.

*r. Red "X" Marker.* Red X signs (fig. 5-22) are placed on roads and trails leading to mined areas. This sign indicates a prohibited area and personnel must proceed with caution or bypass this area. These signs are used in Viet Cong controlled areas.



①  
Figure 5-15. Rock markers on trails.

they pass the sign. The danger area is usually 50 to 200 meters beyond the signs. These signs are usually placed in enemy rear areas and are probably scheduled for removal in the event friendly



Figure 5-15. <sup>2</sup>—Continued.



Figure 5-17. Vehicle track markers.



Figure 5-16. Spaced stick or stone marker.

8. Sign Markers. Various handwritten signs (fig. 5-23) have been encountered warning all persons entering a particular area that a danger exists if



Figure 5-18. Stakes with X marker.



Figure 5-19. Vine markers.

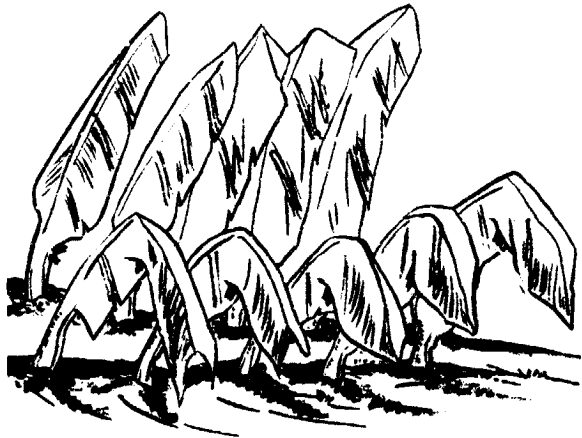

Figure 5-21. Palm leaf patterns.

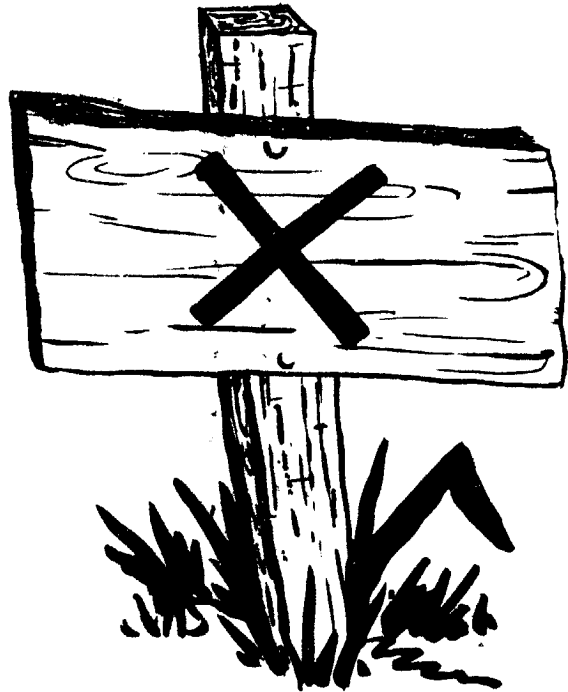

Figure 5-22. Red "X" marker.

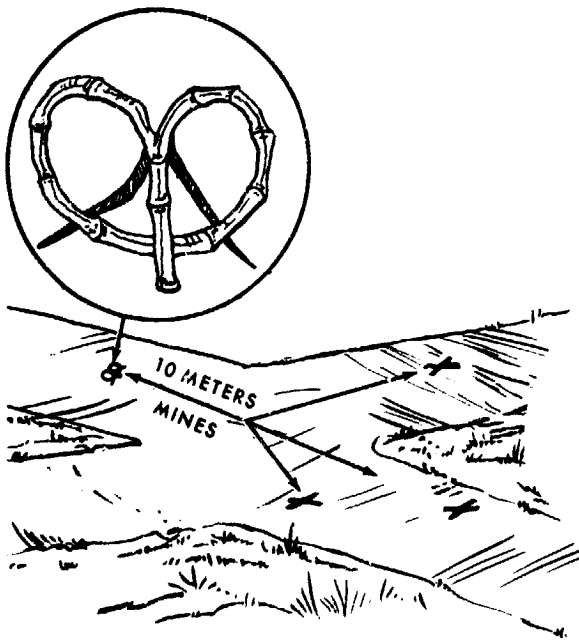

Figure 5-20. Cloverleaf device.

troops initiate operations in the area. Signs may be placed on trees, posts, fences, stakes, or scratched or painted on roads, paths, and trails.

*t. Instantaneous Grenade Markings.* Grenades without delay elements have been found marked with a dot of paint on the grenade body. Red, green, and white dots have been used, and there appears to be no set color pattern as long as the grenade is identifiable to the Viet Cong as instantaneous.



Figure 5-23. Various signs.



Figure 5-24. String markings (entrances).



(MINES OR BOOBYTRAPS IN IMMEDIATE AREA)

Figure 5-25. Goalpost marker.

*u. String Markings.* Boobytrapped dwellings, caves, and tunnels have been found marked. One to three pieces of string are placed at or above entrances (fig. 5-24) to indicate that the installations are boobytrapped. There is no regularity as to color, length, or type of string. Strings are usually short, 2 to 12 inches long. As with most markings, the strings are inconspicuous to the casual observer but readily apparent to the Viet Cong.

*v. Goalpost Marker.* Two sticks stuck vertically into the ground with a third stick lashed horizontally to the other two form a Viet Cong goalpost marker (fig. 5-25). The structure is 6 to 18 inches tall. It indicates that mines or boobytraps are in the immediate area.



## SECTION VI

### DEFENSE AGAINST VIET CONG MINES AND BOOBYTRAPS

---

**6-1. Training and Discipline.** In spite of the high incidence of mine and boobytrap activity by the Viet Cong and their ingenious methods and techniques, U.S. personnel can learn to combat such tactics through proper training and strict discipline in the field. The Viet Cong do make mistakes, and the material used in their mine and boobytrap activities is rarely 100 percent reliable. As mentioned previously, the Viet Cong rely on hasty and careless methods of detection and removal by U.S. forces to achieve a high degree of success. For example in 1968, reports indicate that U.S. Army elements unintentionally actuated approximately 50 percent of all the enemy mines and boobytraps which they encountered. Certainly there is room for improvement in our defense against Viet Cong mine warfare. However, there is no room for careless mistakes in mine warfare, and every soldier must be familiar with the methods of defending himself and his unit against mines and boobytraps. Through an understanding of Viet Cong employment of mines and boobytraps, proper defensive measures have been developed. They must, however, be diligently applied in the field to be of any value. Unit leaders and commanders at all levels must establish proper countermine procedures (SOP's), indoctrinate their personnel in these procedures, and enforce their application. This section includes suggested defensive measures to minimize U.S. casualties and promote greater unit combat effectiveness.

**6-2. Precautionary Measures.** *a.* An important precaution is to prevent U.S. material and equipment from falling into the hands of the Viet Cong. Such equipment and material is inevitably reused against U.S. forces. Much loss of U.S. materiel can be prevented by proper security of stocks, careful police of the battle area and stringent enforcement of unit supply discipline. Although explosive litter in the battle area which is not po-

liced-up will obviously be converted to boobytrap or mine applications, additional care must be exercised to prevent such apparently harmless items as dead batteries, communications wire, and so on from being obtained for mine and boobytrap application. For example, C-ration and soda cans are simply thrown away in many cases. Yet these cans are widely used in a simple but effective grenade boobytrap. All such cans should be systematically crushed and buried. Rear area trash dumps must also process cans or otherwise control sources of cans. It is meaningless to bury cans in the front lines with large uncovered dumps remaining open in rear service areas. Remember that 90% of Viet Cong mine and boobytrap materials to include raw explosive comes originally from U.S. sources. The enemy has relied heavily on his in-country production capability and the majority of his mines and boobytraps have been homemade.

*b.* In conjunction with the overall control of U. S. material, the individual soldier must be aware of the requirement for meticulous control of ammunition. Some abuses of ammunition control include improperly attached grenades which fall off during movement through the brush, discarded ammunition considered unserviceable because of dirt, tarnish, mud or other avoidable conditions or minor imperfections, and excess stocks of ammunition which is discarded when a unit moves on short notice taking only its basic load. Small unit leaders must maintain close supervision and accountability of ammunition to include inspections and inventories before and after a mission. Close compliance with all directives relating to ammunition control is a necessity. The problem of munitions control and especially "dud" munitions is being considered on all levels and is a critical preventive measure.

*c.* Local commanders should establish and maintain safe intervals in the movement of troops and

vehicles as the situation dictates. The effect of many antipersonnel mines and hand grenades employed by the Viet Cong is such that more than one individual will become a casualty within the effective casualty radius. This is especially true since the Viet Cong tend to mine areas where troops will habitually bunch up such as breaks or defiles through heavy vegetation. Viet Cong success in mine warfare can be drastically reduced by the simple application of good interval discipline in the movement of troops and vehicles.

d. Wheeled and tracked vehicle operators should be instructed to "track" the vehicle ahead when that vehicle is in sight. This will reduce the possibility of detonating a pressure activated mine which the vehicle ahead may have missed. On the other hand, old tracks should be avoided if possible, because the Viet Cong commonly place mines in old tracks.

e. U.S. soldiers are understandably eager to go to the aid of fellow soldiers who have become mine casualties, but they should do so with extreme caution. Secondary mines or boobytraps are often emplaced for the purpose of inflicting additional casualties on the personnel grouped around the wounded. The man nearest each casualty should carefully clear his way to the individual and render first aid. Under no circumstances should unit leaders permit soldiers to crowd around the wounded and present another lucrative target. A brief search for other explosive devices in the immediate vicinity should be made if possible in recognition of the enemy practice of grouping mines in interrelated multiples.

f. The flooring of vehicles should be sandbagged to provide protection for mounted personnel. Personnel riding in vehicles must keep arms and legs inside vehicle to achieve maximum protection from sandbags. As an additional recommended precaution, a heavy rubber mat should be placed over the sandbags to reduce fragments such as stones, sand, shrapnel, and pieces of bag. To further reduce the possibility of fragments, sandbags should not be filled with rocks or sand with rocks in it.

g. The speed and spacing of individual vehicles can be varied so as to make the timing of command detonated mines more difficult. Key personnel, who are prime targets for command initiated mines, must not congregate in one vehicle but be dispersed through the column. Whenever possible, vehicles should avoid traveling singly as

they may be targets for Viet Cong seeking weapons and other equipment.

h. It is very important to avoid establishing a consistent pattern of behavior upon which the Viet Cong can rely either to emplace a mine or to attack a target. Patrols should follow different routes out and back from their patrol base. Times for patrols or other movements should be random and without pattern. At times the flanks of a road are boobytrapped out to 250 meters as an obstacle to road sweep security teams. When trafficability permits, tanks moving off and parallel to the road during road sweeps can detonate these boobytraps and reduce tank road mine incidents. Indiscriminate alteration of tank travel between road and adjacent terrain will make deliberate mine attacks on the sweep parties more difficult.

i. Personnel exposed to mine threats must wear body armor and helmet. In addition, nylon protective armor for the abdominal area, groin and lower back is available in depot. This armor provides significant additional protection and is particularly recommended for sweep team members. The basis of issue is one per authorized set of body armor. Ask for Armor, Body Fragmentation, Protective (For the Groin), FSN 8470-753-6112.

j. The buddy system not only is useful in training inexperienced men, but also provides an extra margin of safety to the individuals who employ it. Two men working the same area together have the advantage of increased detection capability, mutual reassurance, and shared knowledge. Remember that a disproportionate number of mine incidents occur among inexperienced, newly arrived men.

k. The best mine and boobytrap detector is an alert and observant point man. He must be rotated frequently or the stress of his job will render him ineffective. Failure to do this leads to carelessness and eventually to a mine casualty.

l. Deep, wide ditches cut along both sides of the road not only have positive drainage benefits but assist in detecting the buried wires of command detonated devices. Clearing road shoulders of underbrush back to effective small arms range removes potential positions for the firers of command detonated mines and makes the emplacement of mines more difficult.

m. The Viet Cong will show themselves only when they want to be seen. When pursuing the enemy be especially alert for deliberately placed

boobytraps along the axis of advance. Boobytraps and mines detected in a tactical situation may be bypassed to continue with the mission. However, they *must* be marked so that those who follow can detect and avoid or destroy them.

n. Security and protection of key bridges is essential to assure tactical mobility and support of our forces. The following precautionary measures are recommended.

(1) Construct floating platforms with protective fenders and sapper booms on all bridges not contracted for pier protective cages.

(2) Regulate all sampan traffic through the use of inspection check points.

(3) Establish observation points at all portable water entrance points upstream from the bridge. These will change as the direction of flow changes.

(4) Indoctrinate security forces with the specific tactics and techniques of underwater sappers and methods of countering them.

(5) Conduct a more extensive investigation of the demolition technique in which a shock wave propelled spout of water destroys the overhead span.

(6) Utilize concussion grenades against underwater sappers. Also a greater concentration of grenades should be thrown during the critical period between 2300 hours to 0300 hours.

**6-3. Detection and Search Techniques.** Detection of mines and boobytraps in Vietnam requires constant alertness and careful observation. The efficiency of the detection effort depends on the knowledge of Viet Cong methods and techniques applied by all U.S. soldiers. Although some individuals or units, such as mine detection teams, will have deliberate search missions, most troops must be trained to detect mines or boobytraps in the normal course of daily activities.

a. Following are recommended methods and techniques of detecting the presence of mines and boobytraps in Vietnam:

(1) Do not wear sunglasses. Sunglasses have been proved to reduce the ability of the soldiers to detect tripwires and camouflaged mines.

(2) Be especially alert for tripwires across trails; along the shoulders of roads at likely ambush sites; in the vicinity of known or suspected antitank or antivehicular mines; across the most accessible route through dense vegetation; at the approaches to and within villages; in and

around likely helicopter landing sites; at the approaches to VC positions; at bridges, fords, and ditches; across rice paddy dikes.

(3) Look for mud smears, grass, sticks, dirt, dung, or other substances on roads; many of these areas will be mined.

(4) Look for evidence of apparent road repair—new fill or paving, road patches, ditching, or culvert work; such areas often conceal mines.

(5) Avoid tire marks, ruts, or skid marks on roads; these areas may conceal mines and should be investigated.

(6) Be alert for any signs placed on trees, posts, or stakes, or painted on roadways. Most of these signs are small and inconspicuous, and although all of them do not indicate the presence of mines, they should be investigated.

(7) Watch for markings, other than signs, which are used by the Viet Cong to mark mines and boobytraps. These markings are even less conspicuous than signs, but they appear as a regular pattern not present in nature: sticks or stones in a line; a broken stick carefully placed on a road or trail; clumps of grass at regular intervals; sticks placed in the ground in an unusual manner; or innocent-looking strings hanging over a roadway.

(8) Watch for wires leading away from the side of a road. Although the Viet Cong usually bury command firing wires, some may be only partially buried or not buried at all.

(9) Be alert for any suspicious item in trees, branches, or bushes; these may be hand grenades, mortar or artillery rounds. Tripwires placed across a trail may be difficult or impossible to detect; but the charge, which is usually placed alongside of the trail or overhead, may be more readily apparent.

(10) Watch for any feature of the terrain which does not appear to be natural. The Viet Cong are very adept at camouflaging traps and pits; however, after a short period of time, the appearance of the installation often changes, if only slightly. Uprooted and cut vegetation dries and changes color. Rain may wash away some of the material placed over pit cover. Excessive material on pit covers may cause them to sink, leaving a depression or crack around the edges. Tops of pits and traps may appear as unusual mounds of a uniform dimension.

(11) Observe the movements of civilians, particularly in areas that have been occupied by Viet Cong. The civilians usually know the locations where most mines and boobytraps have been

placed in and around their villages. They avoid these areas. They may walk on one side of a road, avoiding the other side. They may walk in the middle of a road, avoiding the sides and shoulders. They may avoid a road entirely. If civilians do not use certain buildings or facilities in the village, it is a good sign that they are mined or booby-trapped.

(12) Viet Cong flags, banners, and miscellaneous VC supplies and equipment are frequently boobytrapped, and they should be investigated.

(13) Nonexplosive traps which are placed at or above ground level are usually well camouflaged but may be detected by careful observation. Spike board plates may be partially concealed in the grass, but the spikes are straight as compared to the irregular pattern of the grass. If nails or wire are used as spikes, they may shine in the sun. The bamboo whip is emplaced horizontally and presents a smooth arc in its cocked position; careful observation will detect this device among the common irregular and vertical vegetation. The long and ball mace and suspended spikes are of such size and configuration as to appear unnatural among tree branches; however, careful observation overhead is required to detect these devices.

(14) Pieces of wood (boards or bamboo) or other debris on a road may indicate the presence of pressure firing devices for antitank or antivehicular mines. These devices are either placed on the surface of the road or partially buried. In either case, they are usually camouflaged. Hasty emplacement or weather conditions often reduce the effectiveness of the camouflage to the extent that the devices may be detected by careful observation. Vehicle operators should be cautioned against carelessly driving over wood, sticks, or other debris on a road.

(15) Be alert for the sound of an exploding cap in a delayed fuze device.

(16) Increasing use by the Viet Cong of the pressure electric fuze makes probing with a bayonet (or any metallic object) a dangerous practice. The bayonet can close the circuit when inserted between the contacts. Several units have been using fire hardened bamboo probes as a field expedient. It is strongly recommended that bayonets not be used as probes and that fire hardened bamboo be used instead.

(17) During both day and night, a lightweight stick (bamboo) or a slender steel rod can be helpful if used at the front to feel for trip wires.

(18) Scout dog teams have proven effective in detecting boobytraps. In utilizing his sense of smell for detecting boobytraps, the dog detects the scent left by the emplacing personnel, not the scent of the device itself. This places a time factor on the dog's ability to detect the device. The length of time after emplacement during which the dog can make a detection is dependent on various environmental factors such as wind, weather (whether wet or dry), and terrain. The scent will be detectable for 1 to 4 days depending on these conditions. Since the enemy generally employs boobytraps shortly after the initiation of friendly operations in a particular area, the devices are usually encountered by scout dogs within a few days of emplacement. A platoon leader of a Scout Dog Platoon estimated that his dogs will alert on from 75 to 90 percent of all freshly emplaced devices. They are also trained to detect freshly turned earth, which further increases their ability to detect newly emplaced mines or boobytraps. The dog uses his vision to detect tripwires and other unnatural elements in his environment. However, he must be taught what to look for by actual experience in a training area. The scout dog's hearing is 40 times more sensitive than that of a human. Dogs have been known to detect a taut tripwire in the dark by the sound waves created by the vibration of the wire. Many dogs detect a trip wire when it touches the body hair on their forelegs or chest. The dogs are usually agile enough to back away from the wire before it is tripped. This action provides an alert for the device. It appears that the dogs' effectiveness in alerting the location of boobytraps is dependent on continual refresher training to maintain his interest in boobytrap detection.

(19) Kit Carson Scouts (Chieu Hoi returnees who are employed by U.S. combat elements to contribute to the counter insurgency mission) have frequently detected boobytraps. Although not specifically trained to detect boobytraps, the scout's native ability for such work is highly useful. When properly employed, scouts work in areas where they have lived or have operated with a Viet Cong unit. Consequently they are familiar with the tactics, procedures and warning employed by the enemy in that area. It is desirable that, whenever possible, the scouts be used to train and instruct American personnel in boobytraps recognition knowledge and skills. The scout's skills at recognizing boobytraps is an excellent resource of a tactical unit.

b. Search techniques are similar to the detection techniques just discussed; however, in the context of this circular, search is a more deliberate action by individuals, teams, or small units in locating mines and boobytraps as compared to detection by all personnel in their daily activities. In listing search techniques, all of the detection techniques previously discussed would obviously head the list; however, they are not repeated here except as clarification when required.

(1) In addition to observing movement of civilians, question them to determine specific locations of mines and boobytraps.

(2) Investigate all gates for boobytrapping with hand grenades or other explosive devices.

(3) Carefully observe overhead and to the flanks of a route through dense vegetation for hand grenades, shells, and other devices or traps placed either on the ground, in bushes, or in trees.

(4) Investigate all Viet Cong flags, banners, and abandoned supplies and equipment for boobytraps.

(5) Investigate entrances to caves, tunnels, and buildings of all kinds for boobytraps, and search the approaches to and vicinity of these facilities for antipersonnel mines.

(6) Visually inspect and probe antitank and antivehicular mines for antihandling devices.

(7) Investigate potential souvenir items for boobytraps (firearms, knives, binoculars, uniforms, and miscellaneous items of clothing and equipment).

(8) Conduct reconnaissance of bridges, drainage ditches, and streams to include both banks, for mines and traps of any kind.

(9) Conduct reconnaissance along the flanks of roads for command firing wires and antipersonnel mines.

(10) Investigate in the vicinity of suspicious signs and other markings which may indicate the presence of mines and boobytraps.

(11) Investigate the interior and contents of any building suspected of being boobytrapped by the Viet Cong. Although most structures in the villages are of no military use to U.S. forces, they must be searched for VC personnel, supplies, equipment, tunnel entrances, and other items or information of military value; there are many opportunities for boobytrapping.

(12) With the high incidence of command-initiated mines, route clearance requires some special precautions and procedures. Road shoulders and adjacent areas should be searched and cleared first

to insure that potential firing positions, firing wires, and boobytraps are eliminated; then the road can be cleared with some degree of safety. Buried firing wires can be exposed and cut by single-toothed rooters operating parallel to and 10 to 50 meters from the road. There must be adequate security for route clearing parties who are occupied with the clearance task and exposed to attack by the Viet Cong.

(13) The Voluntary Informant Program (VIP) is a countrywide MACV program to encourage Vietnamese civilians to volunteer useful information on the Viet Cong and North Vietnamese Army activities for cash or material rewards. Other non-divisional units have similar programs which give rewards for the location or recovery of mine and boobytrap material, equipment, and so on. The success of VIP is dependent on the degree of command emphasis and psychological operations support given the program and the security established in the area. On the spot payments of rewards to informants increase the effectiveness of VIP. Many informants are children. Ordnance of friendly origin constitutes the highest percent of equipment turn-ins. Many possibilities exist for improving or emphasizing VIP type programs. This is an excellent way to destroy in-place mines or to prevent manufacture of mines by retarding enemy sources.

6-4. Immediate Action Upon Mine Activation. a. When a device is tripped, it is recognized that little reaction time exists once the detonation chain starts. The maximum delay for the M-26 and foreign grenades ranges from 4-9 seconds. If the delay element has been modified, the minimum fuze delay will be less than 1½ seconds. However, since the time available cannot be predicted, certain immediate action can assist in reducing casualties and the degree of personal injury. This action is designed as a reaction to minimum fuze delay.

b. The following steps are the immediate actions required when tripping or activating an enemy device.

FIRST: Be alert for the "pop" of the exploding cap, the tug of the tripwire, or the warning of another soldier.

SECOND: Sound a warning so that others may take cover.

THIRD: Drop to the ground immediately.

c. Do not attempt to outrun the explosion. The 800 fragments of the M26 grenade have an initial

velocity of over 5000 feet per second. During the available delay, however brief, an individual can best remove himself from the cone of the explosion by dropping to the ground. He *must* assume a minimum fuze delay in every case. If possible when dropping to the ground, present the smallest target to the force of the explosion by pointing the feet in the direction of the charge. All those nearby should drop to the ground when the warning is sounded.

d. As mentioned earlier, do not immediately rush to the aid of the wounded soldier. Frequently there is a second boobytrap in the vicinity of the first. The man nearest each casualty should carefully clear his way to the individual and render first aid. Under no circumstances should the unit leaders or others crowd near the wounded men. Conduct a brief but careful search for other explosive devices in the immediate vicinity before moving on.

**6-5. Disarming Methods.** The first essential step in defending against Viet Cong mines and boobytraps is detection of mined and boobytrapped areas or facilities and location of the devices. Once this is accomplished, the safest procedure is to avoid or bypass these areas or facilities. However, it is seldom tactically possible or feasible to do so. Although some mines and boobytraps can be bypassed temporarily, most of them must be dealt with immediately. Trained personnel with the attacking forces can render most mines and boobytraps safe to allow passage of troops and vehicles, while EOD teams and other specially trained personnel can completely neutralize these devices as well as those which may have been bypassed as being too dangerous to handle. Complete neutralization of an explosive device is a highly skilled technique requiring specially trained personnel. It is not the intent of this circular to make specialists of its users. It is the intent to provide fundamental guidance in the neutralization procedures which can be followed by troops in the field.

a. *Neutralization.* Neutralization is simply making a mine or boobytrap safe to handle. It involves two basic steps. The first is disarming or replacing the safeties in the firing assembly. The second is defuzing or separating the firing assembly from the main charge and the detonator from the firing assembly. If neutralization is not possible, the device must be destroyed.

b. *Destruction in Place.* A mine or boobytrap may be destroyed in place if some damage is ac-

ceptable and if the tactical situation permits. Antipersonnel mines and boobytraps out of doors are usually destroyed in place with no adverse effects. The device can be initiated by its own mechanism and riggings, or by detonating an explosive charge adjacent to the mine or boobytrap. In any case, all personnel must be in a covered and/or at a safe distance. Antitank mines emplaced in a road can often be destroyed in place if the damage will not seriously impair vehicular traffic; however, charges placed under a road are often of such size that detonation would create an appreciable obstacle. Charges placed on bridges, in built-up areas, and indoors usually must be removed rather than destroyed in place.

c. *Removal of the Main Charge.* Before attempting removal, careful probing around the main charge is necessary to locate and neutralize antihandling devices. To avoid casualty, the type of firing mechanism must be identified and all safety devices must be replaced. If complete neutralization seems doubtful, the charge should be pulled from place by a grapnel or rope from a safe location. After pulling the charge, personnel should wait at least 30 seconds as a safeguard against a concealed delay action fuze. Use of the grapnel is recommended for most Viet Cong mines and boobytraps, which are largely improvised with fuzes and firing devices having no safeties.

d. *Expedient Grappling Hook.* The nose plug of the 175mm and 8 inch howitzer rounds with a small portion of the metal ring removed so it will act as a hook is an excellent means to trigger tripwire firing device boobytraps. Presently the grappling hook and rope is the recognized method to trigger these devices. In order for each squad to have the capability of breaching such obstacles, three to four grappling hooks, with an ample amount of rope to allow the device to be triggered at a safe distance, are required to be effective. By using the nose plug of these artillery rounds with a lightweight rope or strong twine, we greatly reduce the weight factor. In addition the small unit leader has the capability to destroy these casualty producing devices by a readily available means. This method should be made known to small unit leaders, particularly those working in areas saturated with boobytraps, in order that they may have the capability of removing these casualty producing obstacles with a simple but very effective makeshift device.

e. *Hand Disarming.* None but trained specialists should attempt hand disarming, unless the mine's

or boobytrap's characteristics and disarming techniques are well known. Only trained specialists should inspect and destroy all unusual or complicated devices. Particularly dangerous are devices equipped with chemical fuzes, dud mortar and artillery shells, hand grenades, and such boobytraps as the bicycle, cigarette lighter, and fountain pen. When hand disarming is absolutely necessary, the following procedures should be used for guidance only, as the exact sequence depends on the type of device and manner of emplacement.

(1) Do not touch any part of a mine, boobytrap, or other explosive charge without first examining it thoroughly. Locate all firing devices and their triggering mechanisms.

(2) When tracing wires, look for concealed intermediate devices laid to impede searching and clearing. Do not disturb any wires while examining the explosive device.

(3) Cut loose tripwires only after careful examination of all connecting objects and after replacing all safeties.

(4) Trace all taut wires and disarm all connected firing devices by replacing safeties. Taut tripwires should be cut only after eliminating the danger at both ends.

(5) Replace safeties in all mechanisms, using nails, lengths of wire, cotter pins, and other similar objects.

(6) Never use force in disarming firing devices.

(7) Without disturbing the main charge, cut detonating cord or other leads between the disarmed firing device and main charge.

(8) Cut wires leading to an electrical detonator—one at a time.

(9) When using a probe, push it gently into the ground. Stop pushing when the probe strikes any object. (It may be a pressure cap or plate.)

(10) Once separated, mine or boobytrap components should be removed to a safe storage or disposal area.

*f. Expedient Lane Clearer.* Viet Cong boobytrap/mine concentrations have been encountered in increasing numbers. They are frequently found near the entrance to Viet Cong base camps. Clearing of these fields by hand is a slow and dangerous process. The following system to clear lanes in boobytrap/mine fields has been developed: First, detonating cord is prepared in 50 foot lengths; three strands of the prepared cord are taped together at 1 foot intervals to form a "lane

clearer." A hand grenade is tied to one end of the cord as a weight. A blasting cap, time fuze and fuze lighter are affixed to the other end of the cord. The detonating cord is then rolled lariat style. The thrower holds the blasting cap end and with an underhanded motion, throws the grenade in the direction of travel. (The grenade is not activated.) The detonating cord is then detonated resulting in a lane approximately 2 feet wide and 50 feet long cleared of tripwires and antipersonnel mines. The above system of clearing lanes has proven effective. The cleared lane is plainly visible since the detonation scorches the ground and/or burns the grass in the vicinity.

*g. Special Precautions.*

(1) Be very cautious in handling delay mechanisms. Such devices should be destroyed in place or marked for treatment by specialists.

(2) Be extremely cautious with hand grenade boobytraps. Most are set to detonate at the slightest provocation, and the delay element is often removed. Destruction in place is recommended.

(3) Wood, carboard, or similar explosive containers, buried for long periods of time, are dangerous to disturb. They are also extremely dangerous to probe if in an advanced state of decomposition. Deteriorated high explosives are especially susceptible to detonation. Destroy in place.

(4) Explosives containing picric acid are particularly dangerous. Contact with metal causes a deterioration in the explosive, forming extremely sensitive salts. These salts are readily detonated by handling.

(5) Certain types of fuzes become extremely sensitive to disturbance after exposure to wet soil. Detonation in place is the only safe method of neutralizing or removing such deteriorated fuzes.

(6) As indicated previously, the possibility exists that a mine or boobytrap may have an electrical activation mechanism, and probing, therefore, should be accomplished with a non-metallic probe to prevent striking contacts and activating the device.

**6-6. Clearing Non-Explosive Traps** In addition to explosive boobytraps and mines, non-explosive traps must be cleared. Although there is no specific doctrine for clearing or neutralizing these traps, many of the procedures and precautions for neutralizing explosive devices can be applied.

*a.* Be alert for other mines and boobytraps in

the area, and insure that individual traps are not further boobytrapped.

b. If traps must be bypassed, they should be clearly marked or guarded for the safety of friendly personnel following.

c. Spike boards and other loose spike devices, and bear traps, which have been sprung from a safe distance, should be picked up and disposed of in order to prevent further use by the Viet Cong.

d. Spike (man) traps should be carefully exposed to reveal the configuration and details of construction. They should then be dismantled and the pits filled in.

e. Extreme caution must be exercised in clearing or neutralizing tripwire actuated traps, such as the mace (log or ball), angled arrow trap, suspended spikes, and bamboo whip. After personnel have been cleared from the area, these devices can be actuated by grapnels from a safe position to the side or rear of the point of impact. The devices can then be destroyed or disposed of as directed.

**6-7. Active Mine Prevention Methods.** The variety of methods and procedures outlined for the detection of mines and boobytraps suggests that no one positive countermeasure exists to nullify the mine threat after the mine has been emplaced. In terms of friendly effort expended versus detrimental effects upon enemy capability, the detection and removal or destruction of in-place mines is inefficient and costly in time, effort, personnel, and material. This leads to the consideration of methods to prevent the successful emplacement of enemy mines in the first place, and to provide the key to effective countermeasures where the enemy is successful in placing mines and boobytraps. The available courses of action are limited, a situation that indicates the inherent advantages that mine warfare offers to a guerrilla force in a large country. Nevertheless, aggressive measures to prevent mine emplacement and to improve knowledge of enemy tactics and techniques should be developed to their full potential as an effective means of defeating enemy mine warfare activation.

a. A first requirement is a combat intelligence mine reporting and information system to establish Viet Cong patterns of employment by frequency, area, type, trend and so forth. Reporting will be covered in the next paragraph. Experience indicates that adequate summary information will

reveal definite preferred areas for mine activity. Defining the mine threat leads to the proper commitment of resources to counter the threat and to economy of force as effort need not be spread over areas with low mine incidence.

b. The most effective tactical countermeasure is the constant physical presence of tactical security forces in the immediate area. This is costly in troop employment, but such security forces have prevented enemy mine activity in clearly documented cases. Not as expensive in terms of troop employment, but still quite effective is aggressive and widespread patrolling, especially at night, to prevent the enemy from gaining unobstructed, cheap access to potential mine sites. Such patrolling requires high levels of experience and skill but is an effective countermeasure.

c. Areas, especially roads, which are not physically watched or patrolled can be periodically subjected to fire. Most units experiencing a significant mining problem have been mapping the incidents from month to month to determine trends, high density areas, and so on. Almost invariably, high density areas are discovered. These areas generally are 100 meters up to a kilometer or two in length along an LOC. While ambush patrols are by far the best means to counter the regular mining, another tactic which should not be forgotten is harassment and interdiction fire. In order to avoid sprinkling extra shrapnel in the area, which causes a hindrance to minesweep teams, only white phosphorous rounds should be used on routine H and I countermine fire along an LOC. Use of such H and I fires should be checked for compliance with appropriate MACV or USARV directives.

d. Other sophisticated techniques exist ranging from the use of night vision devices to aggressive actions against the enemy munitions workshops. Most are beyond the scope of this TC. However, the few active countermeasure measures mentioned, such as ambush patrolling, offer a decidedly efficient, positive alternative to reduce the enemy mine threat in comparison to the difficult tasks of mine detection and removal.

#### **6-8. Reporting.**

a. A standard enemy minefield reporting procedure as outlined in FM 20-32 is not completely appropriate for operations in Vietnam, but this does not negate the importance of reporting Viet Cong mines and boobytraps. FM 20-32 states that any knowledge or suspicion of the existence of any



enemy minefield must be reported to the next higher command immediately. Although it may not be possible to identify Viet Cong minefields as such, the presence of mines and boobytraps must be reported to the next higher command as readily as if a major minefield had been encountered.

b. The first immediate concern is by the person or persons who first encounter a mine or boobytrap and against whom the initial casualties may be inflicted. The small unit, squad or platoon, has a vital, immediate personal and tactical interest in the incident. It will take appropriate countermeasures. However, mine and boobytrap activities involve a much wider sphere of tactical consideration than the squad or platoon. Small unit tactics are part of a larger scheme of maneuver; therefore, the existence of enemy mines and boobytraps must be reported to company, battalion, and higher levels of command for planning, direction, or assistance as required. The information is disseminated laterally to other friendly units for any adjustments to their plans that may be necessary.

c. Division, corps, field army, or other major commands planning future operations are vitally concerned with Viet Cong mine and boobytrap activities. Timely and accurate reports from the field provide the necessary data for correct action. Collection of individual, and sometimes isolated, incidents can, through intelligence production procedures, reveal valuable information. Of primary concern are the locations of mine and boobytrap incidents; the frequency and intensity of activity; the degree of mine and boobytrap activity against civilians as compared to military application; the correlation between the use of mines and boobytraps and Viet Cong tactics; and the quantity and types of hardware currently employed by the Viet Cong.

d. Reports of Viet Cong mine and boobytrap activities provide an important technical intelligence tool which benefits not only the higher echelons of the intelligence system but the using units as well. Dissemination of mine and boobytrap information, other than initial reports, usually is not accomplished effectively between units in the field. Reports must be forwarded up to a point of synthesis where information can be evaluated and assembled into usable intelligence data and then disseminated to all units concerned. Troops in Vietnam must know the types of mines and boobytraps being employed by the Viet Cong, the manner in which they are employed, and recommended countermeasures. This can only be accomplished by an effective reporting system.

e. Detection and the initial collection effort are accomplished by troops in contact with the Viet Cong, and every effort should be made to open information channels to explosive ordnance disposal (EOD) teams and other technical intelligence units. EOD teams are available to disarm, inspect, destroy, and otherwise process mine and boobytrap items through their channels. The Standing Operating Procedure (SOP) of each unit should clearly define reporting procedures to insure completeness, accuracy, and conformity to the SOP of the entire command. A well-planned and executed mine and boobytrap SOP will insure the collection, processing, and dissemination of information as well as the proper disposition of mine and boobytrap hardware.

f. The destruction, in place, of mines and boobytraps should not go unreported. They should be reported by number, type, location, and circumstance. When possible, photographs and sketches should be made before destruction and forwarded through intelligence channels in accordance with the SOP. In some commands this information may appear in the Intelligence Summary (INTSUM). Progress reports should be submitted on route clearing operations at intervals specified in the SOP. Many units include this information in a Daily Situation Report (SITREP).

g. No mine or boobytrap incident should be considered too small or inappropriate to be reported. What may appear to be routine and repetitious to one unit may be of great significance to others. Training literature and training programs concerned with enemy tactics, techniques, and equipment are based on reports from many sources, and any breakdown in the reporting system will ultimately reduce the efficiency of the Army in the field.

h. Frequently, units are reporting detonated mines as containing 20, 30, 40 or more pounds of explosive. In order to be somewhat surer in these guesstimates, use a crater analysis to relate to the size of charge. The Mine Warfare Center conducted a crater-charge test, using TNT placed at a depth of 6 inches, and the results in table 6-1 should be related to all mines blown in place.

Table 6-1. Crater Size Vs Charge Weight.

Lb TNT	Crater width	Crater depth
1	2'5"	0'11"
5	2'6"	1'0"
10	4'10"	1'6"
20	6'7"	1'10"
30	7'6"	1'10"
40	7'8"	3'6"
50	9'6"	4'0"

INSTRUCTIONS FOR COMPLETING MINE/BOOBY TRAP REPORT

The Mine/Booby Trap Report is especially designed so that when completed the data contained on it can be readily extracted and placed in an Automated Data Processing (ADP) file. Although the form is largely self-explanatory, the following specific guidance is provided to insure that personnel completing it understand exactly what information is required.

1. The first line must be completed. Blocks 1 through 19 and block 26 should be filled in. Blocks 20 through 25 will be filled in by CMEC personnel, but the individual completing this report must enter the name of the province and his unit designation on the lines provided.
2. Blocks 27 through 43 if unknown or not applicable should be left blank.
3. Blocks 3 and 4 should be completed as 01 for January, 02 for February, etc.
4. Blocks 5 and 6 should be numbered 01, 02, 03, etc. for the corresponding day of the month.
5. Blocks 11 through 18 should show a two letter, six digit grid coordinate. For example: YS634245. If only a four digit coordinate is known, the third and sixth digits should be entered as zero. For example: YS630240.
6. Blocks 38 through 41 must be completed. If there were no casualties, zeros should be entered.
7. The "REMARKS" blocks should normally be used only to amplify items 27, 28, 29, or 32. The remarks should be prefaced with the item number. For example:

44

28	-	B	J	C	Y	C	L	E	32	-	M	E	C	H	A	N	I	C	A	L
----	---	---	---	---	---	---	---	---	----	---	---	---	---	---	---	---	---	---	---	---

Figure 6-1. Instructions for completing mine/boobytrap report.

i. A standard form mine/boobytrap report is currently used in Vietnam to collect valuable information of mine and boobytrap incidents. Data compiled has assisted the establishment of trends in enemy mine deployment. Enemy trends have been disseminated to the units concerned as usable intelligence data. The form may be used as a guide for collecting intelligence data in locations other than Vietnam if no standard procedure exists. (See figures 6-1, 6-2, and 6-3.)

j. The Mine Warfare Center, Engineer Section, USARV, has been established to coordinate countermine activities in Vietnam, to analyze data relative to mining incidents, and to serve as a point of contact with CONUS activities. Unusual Viet Cong methods, techniques, hardware, training manuals, and so forth should be forwarded through appropriate channels to this agency for review and action.

### MINE/BOOBY TRAP REPORT

1. YR  2. MO  3. DAY  4. HOUR  5. LOCATION  6. CTZ  (1,2,3,4)

7. TYPE EXPLOSIVE  8. ORIGIN  9. SIZE OF CHANGE  10. CIVIL IN AREA  11. TYPE FIRING DEVICE  12. LAST FRIENDLY MESSAGE

13. MINE  14. USSR  15. 0-10 lbs  16. None  17. Pressure  18. 0-1/2 hrs

19. Claymore  20. 11-20 lbs  21. Hostile  22. Pressure Release  23. 1/2-3 hrs

20. Grenade  21. 21-40 lbs  24. Friendly  25. Pull  26. 3-6 hrs

21. Arty/Mortar  22. Over 40 lbs  25. Indifferent  26. Tension Release  27. 6-12 hrs

22. Bomb  23. E. German  26. Command Pull  28. 12-24 hrs

23. Other\*  24. Other\*\*  26. Tripwire  29. 1-2 days

24. EC Scout  25. VC/NVA Mine Marker  26. Time Delay  27. Over 2 days

25. Other\*  26. Other\*\*  27. Notes in Remarks: Chem, Elec, or Mechanical

28. PROVINCIAL NAME AND UNIT DESIGNATION

29. DO NOT FILL IN THESE BLOCKS

30. UNIT

31. Write in PROVINCIAL name and UNIT designation on above lines. ICBM codes will be filled in by CHEC.

32. 33.

34. PER VEHICLE INCIDENTS ONLY - Leave BLANK If Not Applicable

35. EXTENT OF DAMAGE

36. LOCATION OF EXPLOSIVE

37. LOCATION OF DAMAGE

1	2	3	4	5	6	7	8	9
L								

38. WHEELED VEHICLE

39. TRACKED VEHICLE

40. VIA KIA

41. VIA CHARIOTRY

42. Has this area been mined previously?

43. 1. Yes  2. No

44. REMARKS

Figure 6-2. Mine/boobytrap report (front).

Sketch of device, wires etc, and their relationship to ground level, showing depths, configuration and dimensions.

---

Sketch indicating location of device in relation to personnel, terrain, manmade features. If a road incident, indicate width, surface material and condition of road.

---

Sketch of VC/NVA Warning Indicators their location in relation to the firing device, and type of explosive.

---

Has this area been mined frequently?      YES       NO        DON'T KNOW

---

Was this a likely area for mining?      YES       NO       IF YES, WHY?

---

REMARKS:

---

Submitted by (Name, Grade/Rank, Org. Title)

Figure 6-3. Mine/boobytrap report (back).

## INDEX

	Paragraph	Page
<b>Antipersonnel mines:</b>		
Baxomine	2-2	2-18
BLU-3B bomb	2-2	2-10
Bounding	2-2	2-6
Butterfly	2-2	2-11
Cast iron	2-2, c	2-6
Claymore	2-2	2-11
Coconut	2-2	2-9
Concrete	2-2	2-5
Directional	2-2	2-7
Hollow bamboo	2-2	2-9
Miniature	2-2	2-7
Mound	2-2	2-5
Mud ball	2-2	2-9
Pipe	2-2	2-12
Shellcase	2-2	2-10
Shotgun shell	2-2	2-12
Skyhorse	2-2	2-11
Soviet PMN	2-2	2-12
Tincan	2-2	2-5
Tes popper	2-2	2-9
<b>Antitank mines:</b>		
Betal	2-2	2-2
Chinese communist	2-2, a	2-2
Concrete	2-2	2-3
Dud shell	2-2	2-3
Plastic	2-2	2-4
Shaped charge	2-2	2-3
Soviet	2-2, b, c	2-1
Viet Cong	2-2, j	2-3, 2-4
<b>Antivehicular mines</b>		
	2-2	5-3
<b>Boobytraps:</b>		
Country of origin (tables 5-5, 5-8)		5-3, 5-5
Detection of (table 5-3)		5-2
<b>Explosive:</b>		
Bamboo arch	4-2	4-8
Bicycle	4-2	4-10
Broken branch	4-2	4-14
Caches	4-2	4-12
Can	4-2	4-8
Cartridge	4-2	4-10
Cigarette lighter	4-2	4-11
Cigarette pack	4-2	4-15
Disguised mine	4-2	4-14
Flag and banner	4-2	4-9
Fountain pen	4-2, j	4-10, 4-11
Fuel tank	4-2	4-13
Gate	4-2	4-9
Grenade	4-2	4-14
Grenade launcher	4-2	4-14
Grenade trap	4-2	4-8
Highway obstacles	4-2	4-11
Sodium device	4-2	4-11

## INDEX

	Paragraph	Page
Tank .....	4-3d	4-8
Thatched roof .....	4-3p	4-12
'Tree mounted .....	4-3o	4-12
<b>Hand grenades:</b>		
Chinese Communist .....	4-2f, g, h, i	4-3, 4-4
Fragmentation .....	4-2o	4-6
Milk can .....	4-2d	4-2
Shaped charge .....	4-2e, n	4-2, 4-6
Soviet .....	4-2j, k, l, m, p	4-4, 4-5, 4-6
Vict Cong .....	4-2m	4-6
<b>Non explosive:</b>		
Angled arrow trap .....	4-4e	4-17
Bamboo whip .....	4-4d	4-17
Bear trap .....	4-4f	4-17
Crow's foot .....	4-4b	4-16
Mace .....	4-4m	4-19
Punji stakes .....	4-4c	4-16
Sideways closing trap .....	4-4k	4-19
Spikes .....	4-4a, g, h, i, n	4-16, 4-17, 4-18, 4-20
Trap bridge .....	4-4l	4-19
Venus flytrap .....	4-4j	4-19
Charge, size of (table 5-6) .....		5-3
Clearing non-explosive traps .....	6-6	6-8
Crater size (table 6-1) .....		6-9
Defense against mines and booby traps .....	6-1	6-1
<b>Demolition charges:</b>		
Bangalore torpedo .....	2-3h	2-16
Cone mine .....	2-3a	2-14
Oil drum .....	2-3g	2-15
Pole .....	2-3f	2-15
Satchel .....	2-3k	2-16
Shaped .....	2-3b, c	2-14
TNT block .....	2-3i, s	2-16
Turtle charge .....	2-3d	2-15
Vo'ume mine .....	2-3j	2-15
Detection techniques .....	6-3	6-3
Devices, types of (table 5-7) .....		5-4
Disarming methods .....	6-5	6-6
Discipline and training .....	6-1	6-1
Explosive devices (table 5-7) .....		5-4
Explosives, types of (table 5-4) .....		5-3
Firing device, types of (table 5-3) .....		5-2
<b>Firing devices:</b>		
Bamboo .....	3-2i	3-6
Electric .....	3-2a, b, c	3-4
Helicopter actuated .....	3-2g	3-5
Hollowed out .....	3-2h	3-6
Mousetrap .....	3-2e	3-5
Pressure pull .....	3-2f	3-5
Wristwatch .....	3-2d	3-5
<b>Fuzes:</b>		
Chemical .....	3-1b	3-1
Chinese Communist .....	3-1f	3-3
Friction .....	3-1a	3-1
Soviet .....	3-1e, d, e	3-1, 3-3
Informant program .....	6-3b(18)	6-5
Markings .....	5-7	5-15
Mine incidents (table 5-7) .....		5-4

## INDEX

	Paragraph	Page
Mine warfare doctrine, VC -----	5-1	5-1
Mine warfare incidents (table 5-1) -----	-----	5-2
Precautionary measures -----	6-2	6-1
Prevention methods -----	6-7	6-3
Reporting (figure 6-1) -----	6-8	6-3
Security -----	6-9a	6-3
Training and discipline -----	6-1	6-1
Tripwires -----	5-3d	5-10
Viet Cong doctrine -----	5-1	5-1
Voluntary information program -----	6-3b(18)	6-5
Water mines, employment of -----	5-5	5-12
Water mines, kinds of:		
Acoustic -----	2-4c	2-18
Bevelled -----	2-4c	2-17
Box -----	2-4g, i	2-19, 2-20
Chemical -----	2-4i	2-20
Floating -----	2-4f	2-19
Limpet -----	2-4d, e	2-18
Magnetic -----	2-4c	2-18
Moored -----	2-4j	2-20
Pressure -----	2-4h	2-19
Soviet -----	2-4i	2-20
Twin can -----	2-4k	2-20
Viet Cong -----	2-4b	2-17

