

MCWP 3-17.3 formerly (FMFM 13-7)

MAGTF Breaching Operations



U.S. Marine Corps

PCN 139 716000 00

E R R A T U M

to

MCWP 3-17.3

MAGTF BREACHING OPERATIONS

1. For administrative purposes, the publication short title has been reidentified. Change *FMFM 13-7* to read *MCWP 3-17.3* wherever it appears in the Manual. Also change the Publication Control Number (PCN) from *13971600000* to *14300012200*.

143 000122 80

DEPARTMENT OF THE NAVY
Headquarters United States Marine Corps
Washington, DC 20380-0001

13 June 1995

FOREWORD

Fleet Marine Force Manual (FMFM) 13-7, *MAGTF Breaching Operations*, provides guidance for commanders and their staffs who plan and conduct breaching operations in support of Marine air-ground task force (MAGTF) operations. It focuses on breaching fundamentals, organization, planning, and types of breaching operations.

Obstacles which limit the MAGTF's ability to maneuver must be overcome. Obstacle breaching allows a force to have continued freedom of movement and restores the capability to wage maneuver warfare.

Recommendations for improving this manual are invited from commands as well as directly from individuals. Forward suggestions using the User Suggestion Form format to —

COMMANDING GENERAL
DOCTRINE DIVISION (C 42)
MARINE CORPS COMBAT DEVELOPMENT COMMAND
3300 RUSSELL ROAD SUITE 318A
QUANTICO, VIRGINIA 22134-5021

Reviewed and approved this date.

BY DIRECTION OF THE COMMANDANT OF THE MARINE CORPS

A handwritten signature in cursive script, appearing to read "C. E. Wilhelm".

C. E. WILHELM

Lieutenant General, U.S. Marine Corps
Commanding General
Marine Corps Combat Development Command
Quantico, Virginia

DISTRIBUTION: 139 716000 00

User Suggestion Form

From:

To: COMMANDING GENERAL, DOCTRINE DIVISION (C 42),
MARINE CORPS COMBAT DEVELOPMENT COMMAND,
3300 RUSSELL ROAD SUITE 318A, QUANTICO, VA
22134-5021

Subj: RECOMMENDATIONS CONCERNING FMFM 13-7, *MAGTF
BREACHING OPERATIONS*

1. In accordance with the Foreword to FMFM 13-7, which invites individuals to submit suggestions concerning this FMFM directly to the above addressee, the following unclassified recommendation is forwarded:

<u>Page</u>	<u>Article/Paragraph No.</u>	<u>Line No.</u>	<u>Figure/Table No.</u>
-------------	------------------------------	-----------------	-------------------------

Nature of Change: Add Delete Change Correct

2. Proposed new verbatim text: (Verbatim, double-spaced; continue on additional pages as necessary.)

3. Justification/source: (Need not be double-spaced.)

NOTE: Only one recommendation per page.

Record of Changes

Change No.	Date of Change	Date of Entry	Organization	Signature

MAGTF Breaching Operations

Table of Contents

	Page
Chapter 1. Introduction	
Challenge to Maneuver	1-1
Overcoming Obstacles	1-1
Types of Breaching Operations	1-3
Breaching Fundamentals	1-5
Breaching Organization	1-6
Intelligence	1-8
Breach Planning	1-11
Chapter 2. In-Stride Breach	
Use	2-1
In-Stride Breaching Fundamentals	2-2
Planning and Task Organization	2-5
Preparing	2-7
Executing	2-7
Battalion In-Stride Breach Scenario	2-9
Chapter 3. Deliberate Breach	
Use	3-1
Deliberate Breaching Fundamentals	3-1
Planning and Task Organization	3-4
Preparing	3-6
Executing	3-8
Continuing the Attack	3-8

Chapter 4. Amphibious Breach

Use	4-1
Types of Amphibious Operations	4-2
Getting to the Beach	4-2
Amphibious Breaching Fundamentals	4-4
Supporting Operations	4-6
Amphibious Assault Sequence	4-8
Continuing the Attack	4-10

Chapter 5. Assault Breach

Use	5-1
Nature of the Assault	5-1
Assault Breaching Fundamentals	5-2
Planning and Task Organization	5-3
Consolidation	5-4

Chapter 6. Covert Breach

Use	6-1
Covert Breaching Fundamentals	6-1
Planning and Task Organization	6-4
Preparing	6-5

Chapter 7. Breach Lane Marking

Marking Systems	7-1
Traffic Control Guides	7-5
Levels of Lane Marking	7-5
Standardization Agreement (STANAG) 2889	7-9
Breach Lane Marking for Amphibious Operations	7-10

Chapter 8. Breach Training

Necessity	8-1
Breaching Rehearsals	8-2
Rehearsal Principles	8-4
Conducting Training Exercises	8-5

Appendixes:

A Breaching Plan Appendix	A-1
B Fielded Equipment and Techniques for Land Operations	B-1
C Contingency Equipment for Land Operations	C-1
D Equipment Under Development for Land Operations	D-1
E Breaching Equipment for Amphibious Operations	E-1
F U. S. Army Breaching Equipment	F-1
G Glossary	G-1
H References and Related Publications	H-1

Index	I-1
--------------	------------

Chapter 1

Introduction

Challenge to Maneuver

Maneuver warfare is the warfighting philosophy of the Marine Corps. This philosophy seeks to shatter the enemy's cohesion through a series of rapid, violent, and unexpected actions. Speed, surprise, and suppressive firepower are key. Maneuver warfare depends on freedom of movement and seeks to avoid enemy strengths in order to focus efforts on enemy weaknesses whenever possible. The enemy will use firepower, terrain, and manmade obstacles to strip our freedom to maneuver. Friendly forces will first attempt to bypass such obstacles; however, this may not always be an option. In this case, breaching operations restore the ability to wage maneuver warfare once again. Obstacles which limit maneuver, whether on land or at sea, must be overcome.

Overcoming Obstacles

An obstacle is any obstruction designed or employed to disrupt, fix, turn, or block the movement of an opposing force, and to impose additional losses in personnel, time, and equipment on the opposing force. Obstacles can exist naturally or can be manmade, or can be a combination of both (Joint Pub 1-02). The effectiveness of an obstacle is enhanced considerably when covered by observation and fire. As friendly forces breach or bypass obstacles they may be exposed to direct and indirect fire. Mines will typically be employed with other obstacle types, such as wire and tank ditches, to create complex obstacles. Complex obstacles are often used to reinforce a natural obstacle feature such as a river, dry gap, or surf zone.

Obstacles can include abatis, antitank ditches, blown bridges, built-up areas, minefields, rivers, road craters, terrain, and wire (FMFRP 0-14). Manmade obstacles can be either tactical or protective. Tactical obstacles limit the attacker's ability to maneuver, particularly mechanized forces, and may or may not be within small arms range. Tactical obstacles are integrated into the defense's scheme of maneuver and fire support plan. Protective obstacles provide close-in protection and are usually placed just outside of hand grenade range.

Obstacle breaching is the employment of a combination of tactics and techniques to project combat power to the far side of an obstacle. Understanding breaching theory is the first step to understanding breaching tactics. Breaching is conducted by rapidly applying concentrated force at a point to penetrate the obstacle and rupture the defense. This is a combined-arms operation. The commander's intent must be understood when planning breaching operations, and the main effort must be clearly designated and supported by other units. The commander should plan to shift personnel and equipment consistent with the main effort. The shift of breaching assets is particularly critical when successive breaching operations are anticipated. He should also plan for redundancy of breaching assets to allow for losses of personnel and equipment.

Breaching Actions

Breaching actions are the tactics that the unit will execute on contact with obstacles. Forces encountering obstacles either attempt to bypass or reduce the obstacles. A **bypass** is a route that avoids the obstacle. Bypassing obstacles must be done with caution to avoid killing zones. **Obstacle reduction** is the physical creation of a lane through or over obstacles. Attempting to force or "bull" through an obstacle is not a breaching operation. It is a desperate course of action undertaken only when a commander must extricate his force from an untenable position within an obstacle and when no other breaching options are available. Normally, engineers and specialized equipment are required to reduce an obstacle. Obstacle reduction is a primary task of ground combat element (GCE) engineers during offensive operations.

After lanes are reduced, proofing may be necessary. **Proofing** is verifying that a breached lane is free of live mines by checking the breached lane with a secondary breaching means other than explosives, such as probing, mine detectors, mine plows, or mine rollers. Proofing is done only when the potential risk of live mines remaining in the lane exceeds the risk of loss due to enemy fire while a force is waiting to proof a lane.

Reorganization

After a force passes through an obstacle, the commander should reorganize the force and determine if it has enough combat power to continue the attack. Resupply of critical materiel must be conducted and assets redistributed for future breaching operations. New support, breach, and assault forces may be designated. Breached obstacles are reported to higher headquarters, marked, and handed over to follow-on units. Higher headquarters is responsible for disseminating obstacle breach locations throughout the command and to follow-on units.

Obstacle Clearing

Obstacle clearing is the total elimination or neutralization of obstacles. Clearing operations are generally not conducted under fire and are carried out by combat service support element (CSSE) engineers and explosive ordnance disposal (EOD) personnel. However, they may be performed by engineers in the GCE, CSSE, or aviation combat element (ACE).

Types of Breaching Operations

In-Stride Breach

An in-stride breach is a rapid breaching technique that task-organized GCE forces may be required to conduct independent of the MAGTF. It consists of preplanned, well-trained, and well-rehearsed breaching actions. The in-stride breach takes advantage of surprise and momentum to penetrate obstacles. The force uses the in-stride breach against either weak defenders

or very simple obstacles and executes it on the move. Forces should always move configured to execute an in-stride breach except when a deliberate breach is planned. Chapter 2 discusses the in-stride breach.

Deliberate Breach

A deliberate breach is used against a strong defense or complex obstacle system. It is similar to a deliberate attack, requiring detailed knowledge of both the defense and the obstacle systems. It is further characterized by a buildup of combat power on the near side of obstacles. Subordinate units are task-organized to accomplish the breach. The breach often requires securing the far side of the obstacle with an assault force before or during reduction. Deliberate breaching operations require significant planning and preparation. Chapter 3 discusses the deliberate breach.

Amphibious Breach

Forces conducting an amphibious assault may be required to conduct an amphibious breach, which is a type of a deliberate breach. This breach is specifically designed to overcome antilanding defenses in order to conduct an amphibious assault. Chapter 4 discusses the amphibious breach.

Assault Breach

An assault breach is used against enemy protective obstacles. Depending on the size and strength of the defensive obstacle system, the assault breaching procedure can be a variation of either deliberate or in-stride breaching techniques. Chapter 5 discusses the assault breach.

Covert Breach

Covert breaching operations are used to secretly pass through obstacles. The covert breach uses elements of the deliberate and in-stride breach. Covert breaching is characterized by using stealth to reduce obstacles with the support and assault forces executing their mission only if reduction is detected. Chapter 6 discusses the covert breach.

Breaching Fundamentals

The breaching fundamentals are suppress, obscure, secure, reduce, and re-supply (SOSRR). These fundamentals will always apply, but may vary in degree based on the situation.

Suppress

Focusing all available fire on enemy personnel, weapons, or equipment in order to prevent the enemy from interfering with friendly forces is critical during breaching operations. Suppression helps to isolate the breaching site and fix the enemy in position. It usually triggers the actual act of breaching. Fire support coordination measures are used to ensure that all fire is coordinated and integrated with other actions at the obstacle.

Obscure

Obstacle reduction efforts should be hidden from enemy observation as much as possible. Consideration is always given to selecting a breaching site where the terrain provides natural concealment from enemy observation. Obscuring smoke placed in the breaching area or between the breaching area and the enemy conceals movement and obstacle reduction activities. Smoke should be employed across a wide front in order to deceive the enemy as to the actual breach site(s). The use of smoke must be carefully planned to degrade enemy observation and fire without significantly degrading friendly fire and control.

Secure

The breaching site is secured by a support force to prevent the enemy from interfering with the breach and assault force(s). A force must control the breaching site before it can reduce the obstacle. This is accomplished by physical occupation and/or suppressive fire.

Reduce

The number and width of lanes created varies with the situation and type of breaching operation. Lanes must be wide enough to allow a force to rapidly pass through the obstacle and continue the attack. The unit reducing the obstacle marks and reports obstacle and lane locations and conditions to higher headquarters. Lanes are handed over to follow-on forces who will further reduce or clear the obstacle when possible. Reduction cannot be accomplished until the suppress, obscure, and secure breaching fundamentals have been implemented.

Resupply

Breaching operations are logistic-intensive. Resupply of critical class V materials, such as demolitions, mine-clearing line charge (MICLIC) reloads, smoke, artillery, mortar, and small arms ammunition must be planned. Equipment such as mine detectors, mine rollers, and plows need to be readily available to continue forward momentum. The commander anticipates when these assets might be used and develops a plan for rapidly moving them forward in order to resupply units. Much of the current breaching and mobility equipment (tanks mounted with mine rollers, vehicles towing the trailer-mounted MK 2, and armored vehicle-launched bridges (AVLBs)) can slow the rate of advance of a mechanized unit. This must also be taken into consideration.

Breaching Organization

The commander task-organizes his forces into support, breach, and assault forces to accomplish the SOSRR breaching fundamentals.

Support Force

The support force mission is to provide suppression to eliminate the enemy's ability to interfere with the breaching operation. All available assets, including artillery, air, and naval surface fire support (NSFS), should be

used to suppress the enemy. The support force also controls and coordinates smoke for obscuration.

Breach Force

The breach force mission is to create and mark lanes that enable the assault force to pass through an obstacle to continue the attack. The breach force deploys and begins reducing the obstacle as soon as enemy fire has been suppressed to the point where it does not prevent the breach force from reducing lanes. It is a combined-arms force and may include engineers, infantry, tanks, assault amphibious vehicles (AAVs), and light armored vehicles (LAVs). The breach force must be capable of providing local security against enemy counterattack.

Assets are allocated based on the number of lanes required. For a deliberate breach, the breach force must be capable of creating a minimum of two lanes for an assaulting task-organized regiment. Two breached lanes per task-organized battalion is highly desired. For an amphibious breach, a minimum of two lanes per colored beach is required. However, the tactical situation may require additional lanes to quickly pass a large assault force through obstacles. The breach force commander should expect a 50 percent loss of mobility assets in executing a combat breach. Therefore, redundancy of breaching assets is essential for mission accomplishment. Lanes must be far enough apart to reduce the effects of enemy fire yet close enough to permit the mutual support and shifting of friendly forces.

Once the breach force has reduced the obstacle and the assault force has passed through breached lanes, guides are left to hand them over to follow-on units. At a minimum, lanes must be marked and their locations and conditions reported to higher headquarters and follow-on units. Chapter 7 discusses breach lane marking.

Assault Force

The assault force mission is to destroy or dislodge the enemy on the far side of the obstacle in order to allow combat forces to continue the attack. It secures the far side by physical occupation in most deliberate breaching operations. If the obstacles are defended by only a small force, the assault force mission may be combined with the breach force mission. This simplifies command and control (C²) and provides more immediate combat power for security and suppression. To overcome the defender during an assault, the commander must ensure that sufficient combat power will remain after sustaining losses during the breaching mission. Figures 1-1 through 1-4 graphically depict the roles of the support, breach, and assault forces.

Intelligence

Battlefield success depends largely on the ability of the commander to “see the battlefield.” The commander must identify how the enemy is using the ground in order to minimize the risk of surprise. This is particularly true when attempting to counter enemy use of obstacles. The locations and types of obstacles encountered are an excellent indicator of enemy intentions. For example, rapid mining across an enemy front may indicate a shift to a hasty defense. Surface-laid minefields may indicate that the enemy intends to resume the offensive through the minefields. Antipersonnel (AP) and antihandling devices may suggest that the enemy intends to remain in a defensive position for more than a few hours. A commander determines such situations by intelligence preparation of the battlespace (IPB).

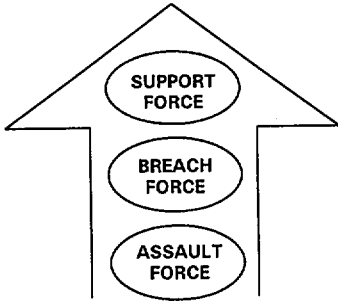

Figure 1-1. Approach.

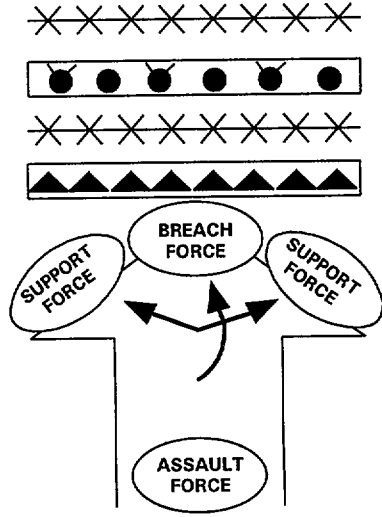

Figure 1-2. Deploy.

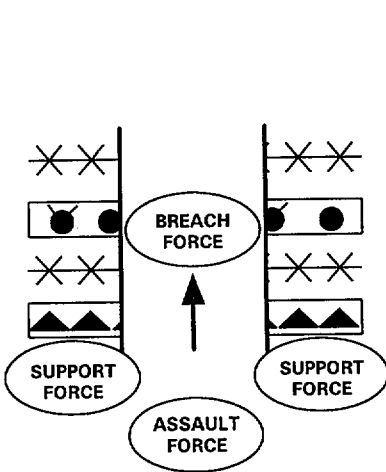

Figure 1-3. Breach.

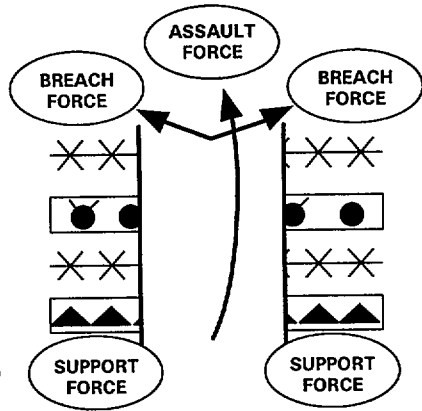

Figure 1-4. Assault.

IPB is a systematic and continuous process that analyzes the enemy, weather, and terrain in an area of operations. The IPB process integrates enemy doctrine and mission with the effects of weather and terrain to evaluate enemy capabilities, vulnerabilities, and probable courses of action (COAs). The IPB process achieves greatest results when all available intelligence-gathering assets are focused to obtain well-chosen essential elements of information (EEIs). Information gathered by reconnaissance becomes the foundation for developing and revising the estimate of the situation.

In any operation where enemy obstacles can interfere with friendly maneuver, obstacle intelligence (OBSTINTEL) becomes an EEI. OBSTINTEL is essential to determine enemy intentions and defensive strength. Areas defended with obstacles may indicate the location of high value targets and key terrain to the enemy defense. Examples of OBSTINTEL include obstacle location, type, and orientations, gaps and bypasses, and the location of enemy weapons.

Obtaining OBSTINTEL normally requires all available collection assets. The ACE may be tasked with identifying enemy fortification and obstacle emplacement activity in the deep battle area. Reconnaissance units task-organized with engineers should collect information on likely obstacle locations. Combat patrols should search for bypasses and identify obstacles. Specific collection tasks are detailed in a collection plan which identifies named areas of interest (NAIs) that focus reconnaissance on gathering information that confirms or denies the estimated enemy situation.

Engineers engaged in reconnaissance for OBSTINTEL should not be used to reduce obstacles during the reconnaissance (although they make ideal leaders for subsequent breaching operations). Inadvertent detonation, enemy detection of cut wire or marked lanes, and the time required during such reduction may compromise and defeat the purpose of the reconnaissance mission. It may also compromise the entire attack. Units encountering obstacles should immediately inform the commander. Rapidly updating previous OBSTINTEL is a constant requirement.

If the enemy has employed mines, it is critical to determine the minefield composition, forward edge, depth, width, types of mines, and mine fuzes that have been used. This information is used to determine which reduction techniques offer the best chance for success and minimize risk to the breach force. This may require a reconnaissance patrol to examine mines within the minefield. EOD units can provide information concerning the functioning of enemy mines. Engineers assist in conducting threat evaluation. Based on knowledge of the obstacles, enemy tactics and equipment, and the time available to the enemy, the intelligence officer and engineer evaluate enemy obstacle capabilities.

Breach Planning

Breaching operations require precise synchronization among support, breach, and assault forces. Synchronization is the orderly arrangement of events to take place during an operation in order to ensure success. Failure to synchronize suppression and obscuration with obstacle reduction and assault can result in rapid, devastating losses of friendly forces. The commander ensures success through proper planning and force preparation.

Commander's Intent

Commander's intent gives subordinates a clear understanding of what the commander wants to do and why he wants to do it. The most important thing for subordinates to understand is what end result the commander desires. Understanding the commander's intent allows subordinates to adapt to changing circumstances and still achieve the desired end result.

The commander should carefully plan breaching operations based on mission, enemy, terrain and weather, troops and support available-time available (METT-T) analysis and force requirements. If information indicates a weak and/or weakly defended obstacle, the commander may elect to employ in-stride breaching techniques. If information indicates a strong

and/or strongly defended obstacle, the commander should develop a detailed plan to employ deliberate breaching operations.

If insufficient OBSTINTEL is available to prepare detailed breaching plans, the force should continuously refine plans to conduct in-stride breaching operations. Information is often acquired from units that have encountered or entered an obstacle zone. In either case, the force should extricate itself and obtain enough information for the commander to make a decision. If available, engineers with the engaged element conduct a rapid obstacle reconnaissance. The lead unit should attempt an in-stride breach of weak or weakly defended obstacles. Follow-on forces should immediately move into overwatch positions and provide suppressive fire on the enemy to help the lead element, and to allow rapid transition to a deliberate breach, if faced with a strongly defended obstacle.

Command and Control

Effective C² is crucial to achieve proper synchronization. C² is integrated into the plan through the use of maneuver control measures and the positioning of key leaders to observe the battle. Maneuver control measures enable the commander to graphically convey on the map his intent, scheme of maneuver, and subordinate unit tasks. Relating unit actions to the terrain is critical to successful execution.

The commander must be positioned to best control the battle. Since effective suppression is critical during breaching, the commander usually positions himself with the support force. This enables him to personally influence the control of fire and facilitate the necessary coordination between breach and assault forces.

Reverse Planning Sequence

Breach planning is driven by the estimate of the enemy situation and begins by identifying enemy and friendly strengths and weaknesses. Appendix A is a sample breach plan adapted from the breaching plan appendix in FMFM 3-1, *Command and Staff Action*. The commander should first

decide how to attack the objective to accomplish the mission. This decision drives the when, where, how, and size of the support, breach, and assault forces. Breaching operations should take advantage of surprise, whenever possible. Sufficient lanes must be created to rapidly project combat power onto the objective, not just to the far side of the obstacle. **Reverse planning** ensures that actions at obstacles support actions on the objectives. The commander designs a scheme of maneuver for the breaching phase of the operation that achieves adequate suppression, obscuration, and security. The sequence below should be used to develop a breaching plan:

- Reverse planning begins with actions on the objectives.
- Actions on the objective drive the size and composition of the assault force.
- Actions on the objective determine the number and location of lanes to be breached.
- Lane requirements and types of obstacles drive the amount and types of breaching assets assigned to the breach force.
- The enemy's ability to interfere with the breach determines the size of the support force and whether the breaching site is to be secured by fire or by force.

Achieving Surprise

In any tactical operation, surprise is essential to obtain the maximum advantage. The effect of surprise should be sought by all units at every stage of action. German *blitzkrieg* tactics during World War II “. . . involved multiple thrusts with reinforcements following whichever thrusts were most successful. The multitude of thrusts created paralyzing uncertainty in the opponent because he could not determine which constituted the real attack.” (FMFM 1-3, *Tactics*.) It is not essential that the enemy be taken unaware, but only that he become aware too late to react effectively. Tactical surprise in breaching operations may be obtained by moving under the cover of darkness, fog, or smoke. Terrain can also be used to mask movement. A supporting force may conduct a feint or demonstration to deceive the enemy as to the actual breach site.

Achieving Mass

Massed combat power is directed against enemy weakness. The location selected for breaching depends largely on weakness in the enemy defense and areas where its covering fire is minimized. If the attacker cannot find a natural weakness, he creates one by fixing the majority of the defending force and isolating a small portion of it for attack. The isolated portion is then suppressed to eliminate effective fires on the breach. Smoke and terrain are used to assist in isolating the force under attack.

The breach force is task-organized and equipped to use several different reduction techniques in case the primary technique fails. Additional reduction assets should be present to handle unexpected setbacks. A 100 percent redundancy of breaching assets per breached lane is recommended to successfully reduce complex obstacles.

Achieving necessary mass for the assault requires the breach force to open enough lanes through obstacles to permit rapid passage and the buildup of friendly forces on the far side. The breach force attempts as many simultaneous breaches as are necessary to ensure that at least two are successful and attempts to create as many additional lanes as possible within its capability. The need for massing assets to breach the current obstacle must be balanced against the need for those same assets to breach subsequent obstacles. A breaching capability must be retained up through the assault of defending positions.

Rehearsal

A well-rehearsed force is vital for successful breaching operations. The complexity of breaching operations makes rehearsals at every level essential to success. A commander must afford subordinates the time to plan how they will execute their assigned missions and to rehearse that plan with their unit. Units should rehearse immediate action breaching drills as well as their support, breach, and assault roles. Rehearsals should focus on the coordination of maneuver among support, breach, and assault forces in order to achieve the SOSRR breaching fundamentals and highlight key tasks. Chapter 8 discusses breach training and rehearsal.



The following excerpt demonstrates how breaching fundamentals were successfully implemented in World War II.

In April 1941, during the German attack on Australian and British forces at Tobruk, Libya, “. . . out of the red sunset a score of Stukas came screaming down to bomb and machine-gun the forward positions. Their ammunition expended, they turned away, to be followed by yet another formation which hurled its bombs on the barbed-wire and the infantry positions . . . Then, as the last Stuka headed for home, its magazines empty, the Germans laid down a deadly barrage of artillery fire on the same positions and, under the cover of dust and growing darkness, the 2nd Machine-Gun Battalion and sappers of the 33rd Panzer Pioneers raced forward to render safe the mines and blast gaps in the wire . . . The men in the forward posts had been so heavily bombed and shelled that they were unable to prevent German penetrations between their widely dispersed posts or to stop them setting up machine-gun nests in their rear.” The next day “. . . when the mist cleared, the situation was even worse than had been feared. The Germans had not only established themselves a bridgehead a mile and a half wide, but had overrun seven of the advanced posts . . .”

Anthony Heckstall-Smith, *Tobruk* (New York: W. W. Norton & Company, Inc., 1959) pp. 67–68.

(reverse blank) 1-15

Chapter 2

In-Stride Breach

Use

The in-stride breach is a breaching operation used to quickly overcome unexpected or lightly defended tactical obstacles. This type of breach maintains the momentum of the attack by denying the enemy time to mass forces at the breach sites. It is the most common breaching tactic used at both the battalion and regimental level and is usually associated with a mechanized force. Units organize for an in-stride breach when the enemy defense is weak and subordinate units of the MAGTF can perform the breach by utilizing organic support, breach, and assault forces. Units also organize for an in-stride breach when conducting—

- Movement to contact.
- Exploitation or pursuit.
- Hasty attacks.
- Passage of lines.
- Retrograde operations when enemy use of family of scatterable mines (FASCAM) is likely.

The in-stride breach is usually controlled by the GCE and enables a MAGTF to seize and maintain the initiative through simple, decentralized, independent breaching operations conducted under the responsive command and control of subordinate commanders. The in-stride breach is normally coordinated and planned by a task-organized battalion or regiment during a movement to contact or hasty attack. The actual breach is usually conducted at the company level. The GCE commander designates specific support, breach, and assault forces, and he is responsible for synchronizing the SOSRR breaching fundamentals through detailed breach

planning and/or well-rehearsed immediate action drills. The commander planning for an in-stride breach must also plan for a transition to a deliberate breach should an in-stride breach fail. An unclear situation (including enemy and friendly obstacle locations) makes it necessary that several lead units be capable of conducting independent breaching operations.

In-Stride Breaching Fundamentals

Suppress

Key to any successful breach is quick and accurate suppression. The support force should be organized with sufficient assets to rapidly suppress both direct and indirect enemy fire. Priority of indirect fire should be to the support force and then on order shift to the breach force. In a movement to contact, the support force should be the lead unit with the breach force following close behind. As obstacles are encountered, the support force suppresses the enemy while the breach force moves forward to reduce the obstacle. After obstacles have been reduced, priority of indirect fire shifts to the assault force as it passes through the breached lanes in order to continue the attack. When maneuvering in a bounding or traveling overwatch, priority of fire shifts to the forward or bounding units.

Obscure

Artillery and mortars are the primary sources of obscuring smoke (see figure 2-1). FMFM 6-8, *Supporting Arms Observer, Spotter, and Controller*, contains additional information. Close air support and naval gunfire can only provide white phosphorus (WP) smoke which creates a rapid smoke buildup, but produces effects of limited duration. Obscuration may also be achieved through the use of smoke pots and smoke grenades. Tanks, AAVs, and LAVs have smoke grenade launchers and may have the ability to self-generate smoke. However, these systems were designed for self-defense and should not be considered as a primary source of obscuration smoke.

Delivery System	Type Round	Time to Build Effective Smoke	Average Burning Time	Average Obscuration Length (meters)/Round	
				Crosswind	Head/Tailwind
155mm	HC	1 - 1 ½ min.	4 min.	350	75
	WP	½ min.	1 - 1 ½ min.	150	50
	M825	½ min.	5 - 8 min.	350	100-200
105mm	HC	1 - 1 ½ min.	3 min.	250	50
	WP	½ min.	1 - 1 ½ min.	75	50
107mm	WP	½ min.	1 min.	200	40
81mm	WP	½ min.	1 min.	100	40
	RP	½ min.	1 ½ - 2 min.	90-150	40-50
60mm	WP	½ min.	1 min.	75	40
5"/54	WP	½ min.	1 min.	150	40

NOTE: Planning factors are meteorologically dependent. Data is based on favorable conditions.

Figure 2-1. Obscuring Smoke.

Smoke Targets. The commander allocates smoke targets and the fire support coordination center (FSCC) plans smoke targets to be executed on order. Smoke targets are fired simultaneously with suppressive fire so that the smoke builds before the breach and assault forces move forward. Smoke is targeted and adjusted to obscure the enemy's observation of the breach without degrading direct-fire target acquisition by the support forces.

Terrain. Commanders should also consider the cover and concealment that an axis of advance offers. Trafficability must also be taken into consideration, particularly when conducting a mechanized breach. The commander must consider the mission and weigh the trade-off of using a more covered and concealed axis against rapidly moving his force.

Secure

Security for the in-stride breach is primarily achieved through effective supporting fire and the speed of the breach. Securing the far side by force interrupts momentum, strains C², and may be an indication that the obstacle cannot be breached in-stride. The breach force can be used, and will be in the best position, to assist the assault force once the breach is made. When the enemy situation is unclear, task organization is driven by the support force requirement to suppress the enemy while the breach force reduces the obstacle. However, when the size of the enemy force is known, force allocation is driven by the size of force required to assault the enemy positions.

Reduce

A mechanized battalion task force should have a minimum of two lanes separated by at least 100 meters, or as terrain dictates, to pass through an obstacle for an in-stride breach. Each lane should be wide enough to accommodate the largest vehicle. Breaching assets are integrated into formations to provide the lead unit(s) (breach force), with an immediate breaching capability.

Resupply

A plan is developed to rapidly resupply critical class V and breaching equipment. The use of trains enables combat service support (CSS) to be performed as far forward as the tactical situation permits. The train concept is a means of internally task-organizing and employing the organic CSS assets of tactical units. Battalion combat trains which provide critical CSS in forward areas are organized to resupply anticipated requirements.

Planning and Task Organization

Breach planning begins with IPB and the engineer estimate. Based on the IPB, the GCE commander planning an in-stride breach develops a fire support plan that will shift priority to the unit that will most likely encounter obstacles. The situation determines task organization and breach planning. Areas where the enemy is likely to use obstacles or has used obstacles in recent activities need to be identified. Likewise, information should be requested from higher headquarters on recent friendly use of obstacles in the area of operations.

The commander and staff anticipate which units are most likely to encounter obstacles while executing the scheme of maneuver. Breaching assets are allocated to the breach force to drive lanes through obstacles to support an attack on an enemy position or the movement of follow-on forces. In general, the breaching assets available restrain a commander from providing a breaching capability to all units. Therefore, priority of engineer force allocation goes to the units most likely to execute a breach. The engineer recommends a task organization of engineer assets to create enough lanes for the breaching unit(s). The commander uses engineers to assist infantry in preparing equipment and conducting breaching rehearsals during mission preparations.

Because the exact location and nature of threat forces and obstacles may not be known, engineers and breaching assets must be distributed carefully to allow the commander to move securely while maintaining forward-deployed support, breach, and assault forces. When available, additional breaching assets are also maintained separately from the breach force. This gives depth and flexibility to the in-stride force enabling the commander to shift breaching assets where they are needed. This is particularly important when the formation is dispersed and obstacle locations are unknown. It also allows the commander to quickly mass forces to transition to a deliberate breach.

The engineer commander moves with the breach force in a position to best control assets. The tactical situation often requires a force to modify its combat organization. Units should train extensively to accomplish this quickly and efficiently.

The commander should maintain control of a mobility reserve which is able to create additional lanes for follow-on forces. This mobility reserve is also used to mass breaching assets in case transition to a deliberate breach is required (see figure 2-2).

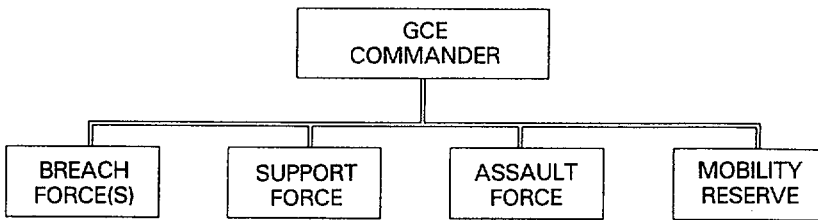

Figure 2-2. Task-Organized Force.

OBSTINTEL

The ability of the force to collect timely and accurate reconnaissance both before and during the attack has tremendous impact on the success of the in-stride breach. The breach will fail if there is not sufficient combat power to suppress enemy fire or enough breaching equipment to reduce the obstacles. Early detection of obstacles is essential to maintaining momentum and to the timely commitment of breaching assets. OBSTINTEL collection is particularly difficult when the in-stride breach is used as part of a movement to contact. Engineers should be attached to the reconnaissance units to gather detailed information on obstacle locations, composition, and orientation.

Details Developed by Subordinate Commanders

The tactical and organizational details necessary for success are developed by the subordinate commanders. In a battalion task force in-stride breach,

the battalion commander task-organizes and designates specific support, breach, and assault forces. Since conducting the breach only involves committing the combat power within the battalion task force, the battalion commander incurs the responsibility to develop plans that synchronize the breaching effort and achieve the SOSRR breaching fundamentals. Battalion breach planning requires the development of immediate action drills for support, breach, and assault forces to automatically execute if unexpected obstacles are encountered.

Preparing

Preparation for the in-stride breach fixes on subordinate unit rehearsals. The success of the in-stride breach depends on the ability of the support, breach, and assault forces to quickly react to enemy and/or obstacle contacts. A battalion prepares for the mission by constructing and managing rehearsal sites that can be used for immediate action drills on contact and at obstacles. It is essential that the battalion rehearse as a combined-arms team. Commanders should include their complete task organization in all orders, back briefs, and rehearsals. During rehearsals, briefings, and debriefings, there should be discussion on how critical breaching assets will be shifted to support breaching operations and also on the transition to a deliberate breach.

Executing

Execution of the in-stride breach is the responsibility of the subordinate commanders. For a battalion in-stride breach, the battalion commander applies the SOSRR breaching fundamentals by synchronizing the efforts of all assets. When the in-stride breach is used because the situation is unclear, the support, breach, and assault force commanders achieve synchronization by executing well-rehearsed actions at obstacles.

The GCE commander has two roles in an in-stride breach which are crucial to breaching success. First, he ensures that the force receives the planned priority of indirect fire and smoke and freedom of action for the support, breach, and assault force commanders to fight their battles. Second, he ensures that the additional combat power and breaching assets needed to transition to a deliberate breach are positioned for immediate response. The GCE commander closely monitors the breaching effort to decisively commit his force to a deliberate breach, if necessary, with minimal loss in momentum.



An in-stride breach scenario can be found on pages 2-9 through 2-16. The purpose of this scenario is to provide one possible tactic for the conduct of an in-stride breach. Commanders must use all available assets at their disposal for conducting breaching operations. The variety of reduction techniques is virtually unlimited and depends on initiative and innovation.

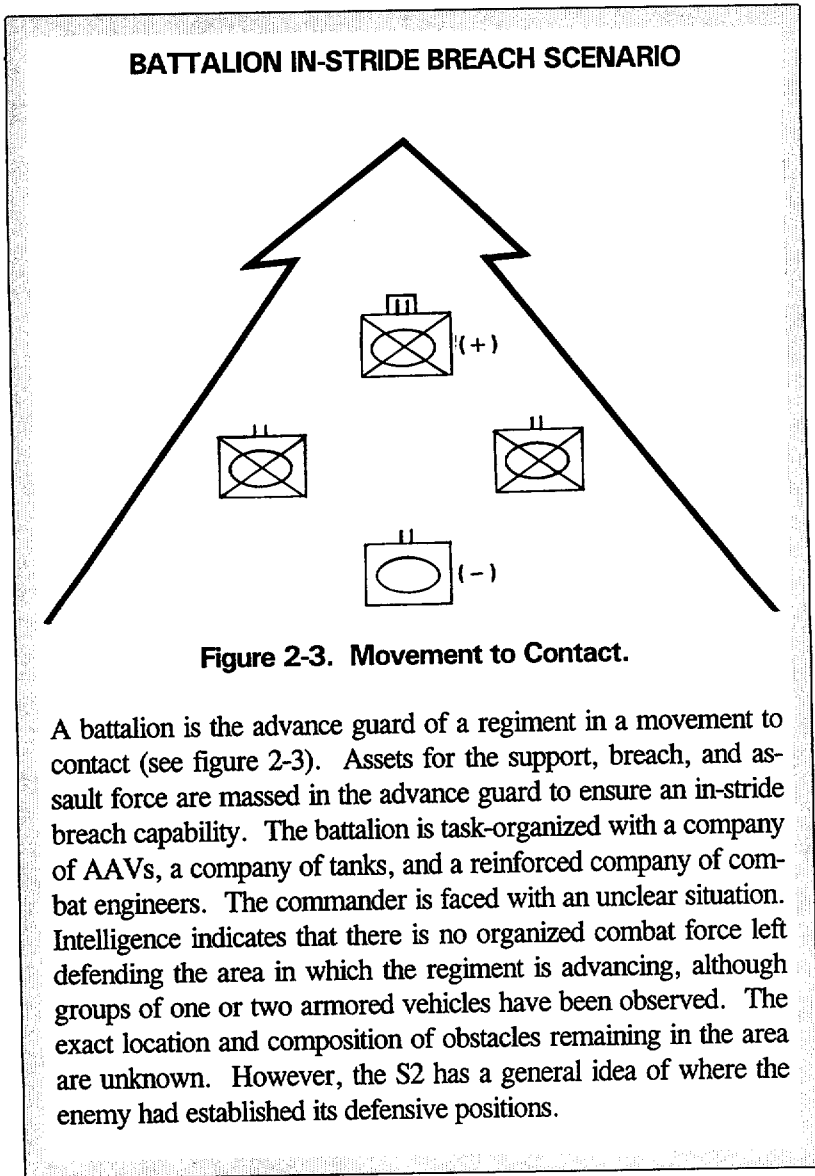

Due to the unclear obstacle situation and need to maintain momentum, the battalion is organized for an in-stride breach (see task organization below). The supporting engineer considers the type of obstacles likely to be encountered and recommends a task organization of breaching assets. The task organization provides for the advance guards to also act as breach/assault forces, two breach sites and lanes, a support/assault force, and a mobility reserve. A redundant and diverse breaching capability is provided to the lead companies. A mobility reserve is maintained under battalion control where it can be shifted to where it is needed. A transition to a deliberate breach is planned by assigning support and assault missions to the remaining units within the regiment and other elements of the MAGTF.

Battalion Task Organization

Advance Guard/Breach Force/Assault Force

Co A Mechanized Co (-)(rein)

2 Infantry Plats

1 Tank Plat with 2 mine rollers and 2 mine plows

1 Engr Plat with 2 trailer-mounted MK 2s and 1 AAV-mounted MK 1

Co D Tank Co (-)(rein)

1 Infantry Plat

2 Tank Plats, total of 2 mine rollers and 2 mine plows

1 Engr Plat with 2 trailer-mounted MK 2s and 1 AAV-mounted MK 1

Support Force/Assault ForceCo B Mechanized Co (+)

- 3 Infantry Plats
- 2 Antitank Squads

Co C Mechanized Co (+)

- 3 Infantry Plats
- 2 Antitank Squads

Mobility ReserveCo E Engr Co (-)(+)

- 1 Engr Plat with 2 armored combat earthmovers, 2 AVLBs, and 2 AAV mounted MK 1s

A screening force leads the battalion formation. Companies A and D are the advance guard. Company B follows in trace of Company A. Company C follows in trace of Company D. Company E is the mobility reserve and follows in trace of Company C (see figure 2-4).

The screening force spots an obstacle system which appears to consist of a minefield and concertina wire and immediately begins searching for possible bypasses. Companies A and D move forward using tanks mounted with mine rollers as the lead vehicles in order to detect the leading edge of the minefield. Company B moves into an overwatch position and provides suppression for Company A as it conducts an in-stride breach. Company C moves into an overwatch position and provides suppression for Company D as it conducts an in-stride breach. Company E prepares to augment Company A or D with additional breaching assets (see figure 2-5).

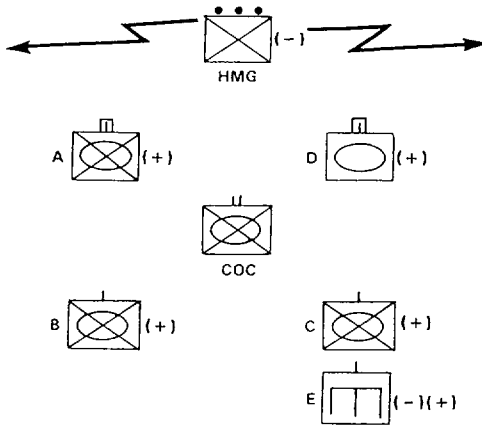

Figure 2-4. Screening Force Leads.

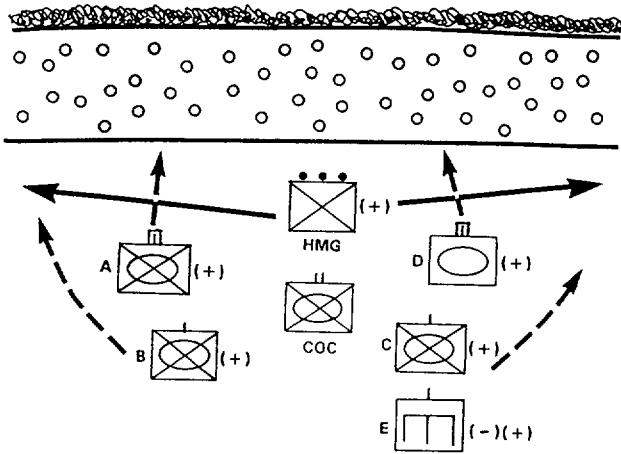

Figure 2-5. Obstacle Sited.

The following sequence depicts how Company A conducts an in-stride breach.

Company A sends a tank mounted with a mine roller to detect the leading edge of the minefield. An amtrack-mounted M.K 1 mine clearance system and a tank mounted with a mine plow follow in trace of the tank with the mine roller (see figure 2-6).

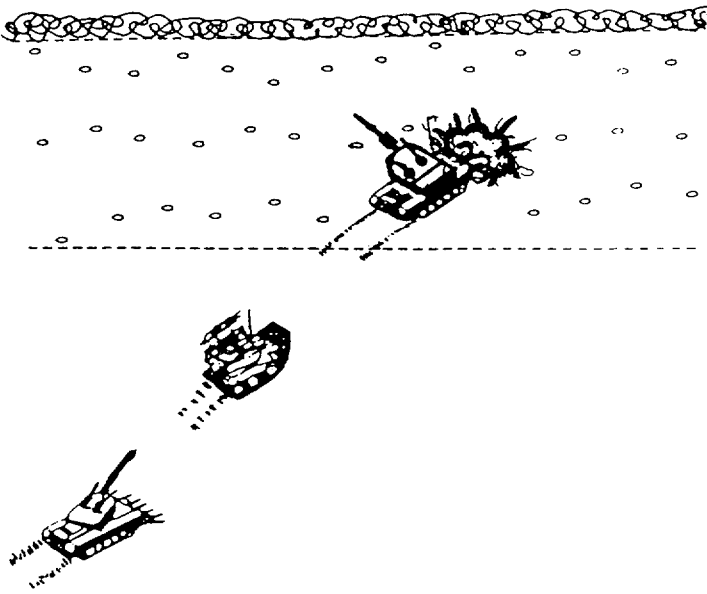

Figure 2-6. Leading Edge of Minefield Detected.

The tank with mine roller detects a mine and backs out of the minefield. The amtrack-mounted MK 1 moves into position 62m in front of the leading edge of the minefield (for standoff distance) and fires a MICLIC (see figure 2-7). For additional information on the MICLIC, see appendix B.

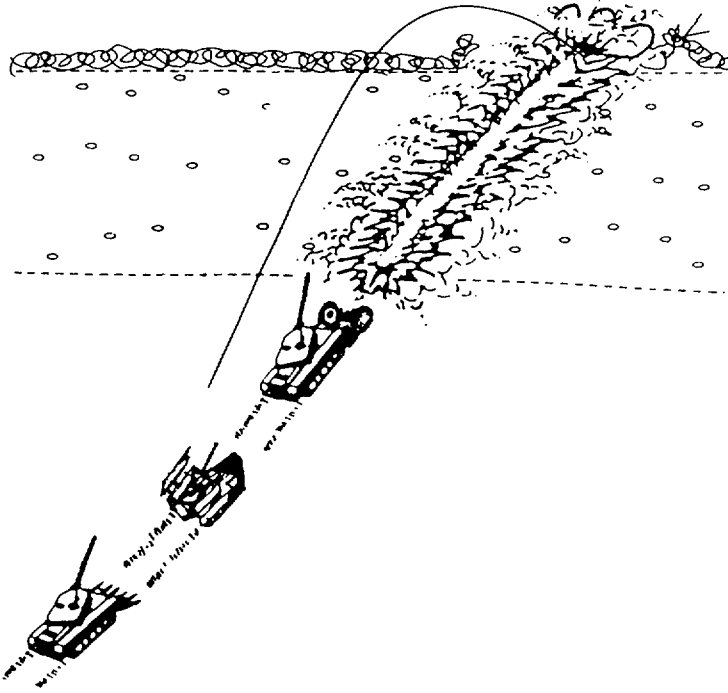

Figure 2-7. MICLIC Detonated.

The tank with mine plow proofs the lane created by the MICLIC followed by the roller to ensure the lane is proofed of mines (see figure 2-8). The MK 1 follows in trace of the mine plow and mine roller so that additional MICLICs are readily available in the event that a second or third MICLIC is necessary to breach the obstacle.

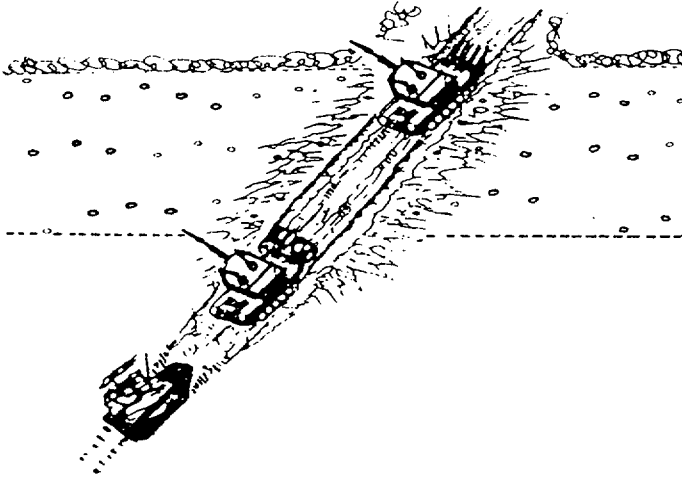

Figure 2-8. Track Width Mine Plow Proofs Lane.

The remainder of the force passes through the breach and engineers mark the location of the breached lane (see figure 2-9).

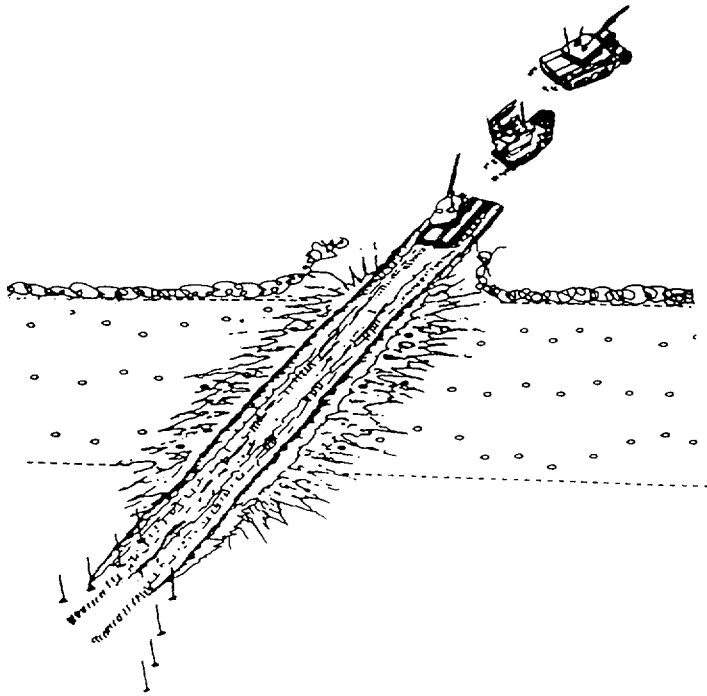

Figure 2-9. Breached Lane Marked.

Chapter 3

Deliberate Breach

Use

The deliberate breach is a type of breach specifically designed to cross a strong and/or well-defended obstacle in order to continue the mission. Units may also conduct a deliberate breach when an in-stride breach fails. The deliberate breach is characterized by thorough reconnaissance, detailed planning, extensive preparation and rehearsal, and a buildup of combat power. The deliberate breach is usually planned at the MAGTF level and involves a GCE force of regimental or division size. One or more subordinate units are specifically tasked to perform the role of support, breach, and assault forces.

Deliberate Breaching Fundamentals

Unlike the in-stride breaching operation, the support, breach, and assault forces for a deliberate breaching operation are given specific objectives and detailed control measures. The force does not have to disperse the support, breach, and assault functions between two or three units to compensate for the a lack of detailed obstacle information during movement.

Suppress

A deliberate breach usually requires more firepower than an in-stride breach. Suppression must be effective against both direct and indirect enemy fire since the breach force may be exposed for a lengthy period of time. Friendly artillery, air, and NSFS assets support the deliberate breach

by suppressing enemy forces capable of firing on the breaching location. This allows forward ground units within the support force to move into overwatch positions from which to provide direct suppressive fire on the enemy.

Obscure

Artillery and mortars are the primary sources of obscuring smoke (see figure 2-1). Offensive air support (OAS) and NSFS can only provide WP smoke which creates a rapid smoke buildup, but produces effects of limited duration. Obscuration may also be achieved through the use of smoke pots and smoke grenades. Tanks, AAVs, and LAVs have smoke grenade launchers and may be able to self-generate smoke; however, these are self-defense mechanisms and must not be relied on to supply all obscuration. Natural limited-visibility conditions (such as darkness or fog) should be exploited, if possible. Training with smoke support is important since smoke can obscure friendly observation and target acquisition, and degrade command and control.

Smoke Targets. The commander allocates smoke targets and the FSCC plans smoke targets to be executed on order. Smoke targets are fired simultaneously with suppressive fire so that the smoke builds before the breach and assault forces move forward. Smoke is targeted and adjusted to obscure the breach without degrading direct-fire target acquisition by the support forces.

Terrain. Commanders should also consider the cover and concealment that an axis of advance offers. However, the commander must consider the mission and weigh the trade-off of using a more covered and concealed axis against rapidly moving his force.

Secure

Securing the breaching site during a deliberate breaching operation is more complex than for an in-stride breach. The defending position will be stronger, reduction may take longer, and there is a strong possibility of a

counterattack. The commander should estimate the time required to complete the breach and ensure that his forces are deployed in time to defeat a counterattack. Detailed and repeated rehearsals produce the most accurate estimates.

Isolate by Fire. The breaching site must be isolated from enemy interference. Artillery, air, NSFS, mortars, and direct fire are used to isolate the breaching site. Air or artillery delivered FASCAM and other situational obstacles can be used to protect exposed flanks against enemy counterattack. Chokepoints along likely enemy avenues of approach are plotted before the operation during detailed fire support and obstacle planning. Reconnaissance assets are tasked to verify the route a counterattack force is traveling.

Physical Occupation. Once the breach site is isolated, the breach force secures the obstacle breaching site by physical occupation. Forces are positioned to defeat local counterattacks and local security is provided for lane-reduction operations and forces passing through the lanes. Assaulting remaining enemy positions covering the breaching site can provide security from counterattacks during lengthy deliberate breaching operations. An infantry assault can be launched once footpaths are cleared through the obstacle. However, this requires careful consideration since the obstacle objective may be to separate infantry from mechanized assets. The assault force can establish blocking positions against counterattacks. Additional forces may be positioned on the flanks of a breaching site.

Reduce

Obstacle reduction is normally the mission of an engineer unit which requires armor and infantry support. In order to diminish the enemy's capability to deliver concentrated fire on one site, the breach force should attempt to reduce a number of lanes simultaneously. A variety of reduction techniques (e.g., MICLICs, mine plows, mine rollers, and manual techniques such as probing, hand-held mine detectors, and hand emplaced explosives) should be used to guarantee success.

The number of lanes the breach force prepares is determined by METT-T. The greater the number of breached lanes, the quicker friendly forces can pass through the obstacles. The breach force deploys in a formation configured to breach specific obstacles. Reducing mined and/or boobytrapped obstacles may require using slow, manual-reduction techniques. An engineer platoon is normally necessary to manually breach each lane. Cleared lanes are marked and guides are left to hand them over to advance elements of follow-on units. Once lanes are handed over, guides rejoin their own units.

Resupply

A plan is developed to rapidly resupply critical class V and breaching equipment. The use of trains enables CSS to be performed as far forward as the tactical situation permits. The train concept is a means of internally task-organizing and employing the organic CSS assets of tactical units. Battalion and regimental trains are organized to resupply anticipated requirements in forward areas. Train positioning must be given careful consideration. The most important criterion is to satisfy the CSS principle of responsiveness and survivability.

Planning and Task Organization

Planning a deliberate breaching operation begins with the command and engineer estimates. The G/S2 provides the estimate of the enemy situation. Both the engineer and G/S2 assess the enemy's tactical and protective obstacles. The staff develops COAs using estimates of the enemy situation and capabilities. The engineer develops a scheme of engineer operations for each COA and recommends whether an in-stride or deliberate breaching operation is necessary.

Assets are carefully allocated to the breach, assault, and support forces to ensure that they can accomplish their assigned tasks. For example, the breach force is tailored with the breaching assets required to counter

specific types of obstacles. The support force is task-organized with the direct and indirect fire systems necessary to provide suppression, and the assault force contains the type of force (mechanized or footmobile) required to seize the objective. Engineers and breaching assets should be allocated to handle unforeseen circumstances.

Mass

Achieving mass is accomplished by hitting the enemy from multiple directions and by narrowing attack zones to concentrate the attacking force against a smaller defending element. Enemy vulnerabilities are identified so that the force can mass direct and indirect fire and maneuver against that weakness. A portion of the enemy is isolated to achieve superior combat power at the breach site. Forces maneuver to create sufficient suppression and security for the breach to be successful.

Economy of Force

When the attack requires breaching two or more complex obstacle systems, sufficient breaching assets must be retained to reduce subsequent obstacles. The commander should not commit all of his breaching resources against the first obstacle system unless he is willing to deplete the capability to breach subsequent obstacles.

Synchronize

Suppression and obscuration must be synchronized with obstacle reduction and assault. This is achieved by a clear understanding of the commander's intent, effective C², reverse planning, and a well-rehearsed force. Figure 3-1 illustrates the need for effective synchronization. In figure 3-1, a MAGTF is conducting a deliberate attack to destroy a mechanized battalion in the defense. The commander believes seizing objective (obj) C to be decisive. This is the point from which reverse planning of battalion actions on the objective begins. The commander visualizes using 1st Battalion to seize the initial foothold (obj B) into the enemy's defense. Therefore, getting 1st Battalion to its objective becomes the focus of

breach planning. The number and location of breaching lanes is driven by 1st Battalion's maneuver on obj B as the assault force. The commander now plans how the breach force must maneuver during the breaching phase of the attack to reduce the obstacle. OAS, artillery, mortar, and supporting fire from 2d and 3d Battalion are planned for both the breach and the attack on the objectives. The CSSE prepares to move additional breaching assets forward to the GCE. Lastly, reverse planning continues to drive the maneuver formation to ensure that forces are in the correct relative positions to accomplish their breaching roles and actions on the objective.

The commander used phase lines (PLs) for command and control. At PL Houston the support force occupied overwatch positions to provide suppression for the breach and assault forces. The commander used target reference points (TRPs) on obvious terrain features to orient, focus, and shift suppressive fire.

Preparing

The task organization should be adjusted as more details of the defense and obstacle system are uncovered. This information is also used during combined-arms breaching rehearsals. If updates become available after the last possible rehearsal, this data must be passed immediately to the affected force elements, especially the breach force.

Rehearsals

Rehearsals should be meticulously planned and managed. The G/S3 should allocate time for each unit to perform combined-arms rehearsals. Rehearsals should include a leader and key personnel walk through as well as individual rehearsals by the support, breach, and assault forces. Where possible, the force rehearses the operation under the same conditions expected during the actual engagement, including battlefield obscuration,

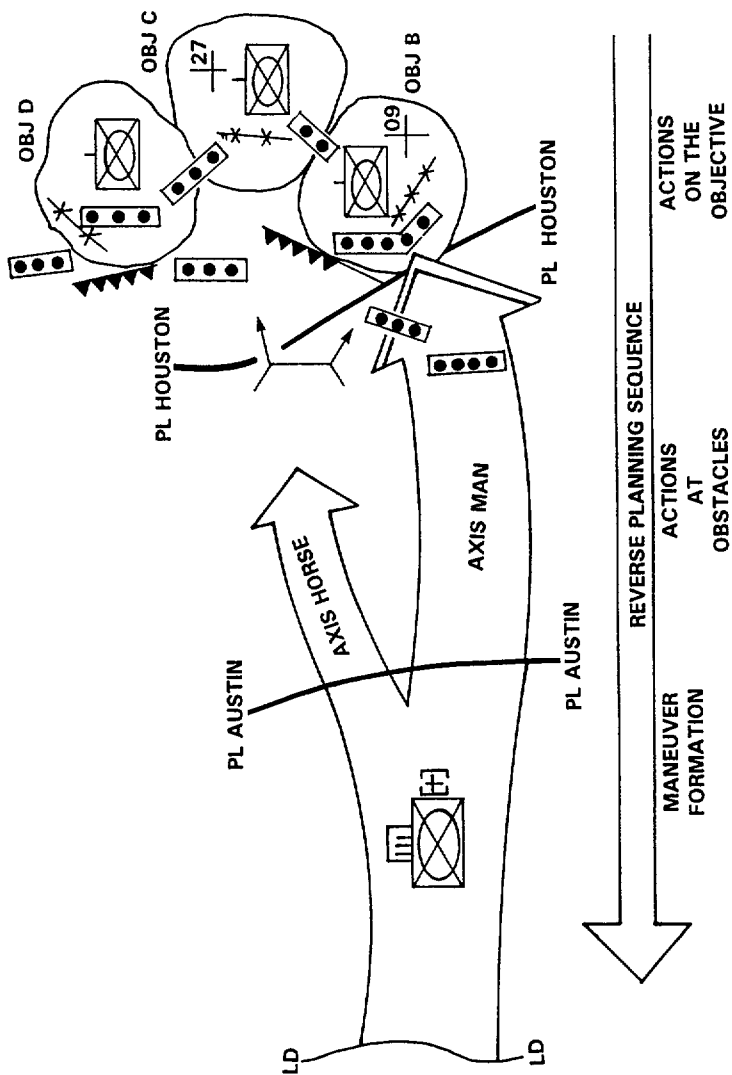

Figure 3-1. Reverse Planning Sequence.

darkness, and inclement weather. The rehearsal site should be similar to the actual terrain and obstacle(s) to be breached. Several contingency plans should also be rehearsed, including possible enemy counterattacks.

Reconnaissance

The success of a deliberate breaching operation depends heavily on OBSTINTEL. The scheme of maneuver is based on known and estimated enemy positions and obstacles. NAIs are developed to confirm or deny the enemy situation. The G/S2 develops the collection plan, with reconnaissance efforts concentrating on confirming enemy locations and OBSTINTEL. Information is used to refine the task organization of support, breach, and assault forces and the scheme of maneuver. For example, if reconnaissance indicates that a possible breaching site is heavily covered by tanks, the support force task organization may be tank-heavy. Since the use of FASCAM is effective for reseeding breaches and reinforcing existing obstacles, particular emphasis is placed on determining enemy FASCAM capability.

Executing

A MAGTF crosses the line of departure (LD) organized for the deliberate breach. A sample execution matrix is provided in figure 3-2.

Continuing the Attack

After passage through the lanes, the force continues its mission. The obstacle system acts as a chokepoint and danger area even after defenses have been overcome. Lane marking is improved as soon as possible. Additional lanes should be constructed to speed the passage of follow-on forces and existing lanes should be widened to allow two-lane traffic

Action	Element	Time	Remarks
Indirect fire and offensive air support provide suppression	Support force		Ground units within support force move to overwatch positions
Ground units in support force provide direct suppressive fire	Support force		
Breach and assault forces move into position	Breach force Assault force		Breach and assault forces prepare to execute tasks
Smoke obscures enemy view of breach site	Support force		
Obstacles are reduced and cleared lanes are marked	Breach force		
Suppressive fire shifts beyond objective	Support force		Coordinate with assault force
Assault force attacks through breached lane	Assault force		
Breach lanes handed off to follow-on forces	Guides from breach force		Can also be done by support force
Resupply critical class III, V, and breaching assets	All forces		Continuous effort
Reorganize to continue mission	All forces		

Figure 3-2. Execution Matrix.

through the obstacle. Switch lanes can be constructed to prevent lanes from being blocked by disabled vehicles or artillery fire. Vehicle recovery is conducted and eventually obstacles are cleared to eliminate the chokepoint.



A deliberate breaching operation was conducted by Allied forces against Axis forces during the 1942 Battle of El Alamein, Egypt. The following provides a summary of that breach and demonstrates the need to be prepared to conduct breaching operations.

“It began in bright moonlight at 2140 hours on October 23 with a shattering bombardment of every known enemy gun position by the entire Eighth Army artillery—just under 900 guns. The shelling continued with maximum intensity for fifteen minutes . . . the guns paused for five minutes as the infantry arranged themselves . . . the guns resumed firing . . . The opening of this new bombardment, which would continue for the rest of the night, was the signal for the assault wave of infantry to advance across no man’s land to the first minefield and its covering outposts—in most cases a mile and a half away. . . .

“Behind the leading infantry followed groups of engineers with the dangerous task of gapping the minefields. . . . each team divided into small groups of two or three. One group would find the mines with the new Polish electronic detectors, a second would mark with tape the lane to be cleared, the third would secure the tape to the ground. Then they would return through the lane on their knees, carefully lifting the mines but first feeling delicately around with their fingers for wires that would indicate that the mines were booby-trapped. . . . Another team would then check the lane and at the same time mark it more clearly with a single strand of wire looped to small pickets along each side, and small hooded lamps were affixed to the pickets as well.

“. . . a great deal of the mine-detecting in the battle had still to be done in the old way—by men crawling forward on their knees while delicately prodding with bayonets. . . . As the antitank mines were the ones that were then being used in the largest numbers, the infantry were expected to take their chance. The serious mine-lifting then took place to clear the lanes for the infantry’s follow-up vehicles bringing their supporting arms and further supplies of ammunition. . . .

"The organized chaos, as soldiers call it, became worse as the night wore on, and the dust thickened into choking suffocating permanency. . . . There were masses of vehicles all over the place and the marking of routes and gaps was very hard to see. It needed only a vehicle or two to stray off the side to remove all the signs and lead everybody into confusion. . . ."

"By daybreak . . . 1st Armoured Division . . . was in fact still bogged down in the minefields about 2 miles back. . . . General Montgomery was dissatisfied with the gains that had been made . . . It was a reiteration of what Montgomery had made clear before the battle; namely, that the armor must be prepared to fight its own way out of the minefields if necessary. This was not a popular notion with the tank generals . . ."

"Throughout the day the Desert Air Force (1,000 sorties) and the United States Air Force (147 sorties) had established complete mastery of the air. They repeatedly attacked the Axis forward airfields, tank and vehicle concentrations, troops and gun positions and prevented the enemy air forces from interfering in the battle."

The attack resumed that night. "At 0130 hours the commander of the leading armored brigade—hampered by the minefields, the shelling, the confusion caused by the blazing trucks, and by heavy casualties—requested permission to withdraw . . . believing he might lose all his tanks and achieve nothing. . . . this was one of the rare occasions when Montgomery must be awakened to pass judgement . . ."

Montgomery " . . . said the tanks could and would go through. . . . At this bleak four-o'clock-in-the-morning crisis when his offensive was beginning to falter, Montgomery accepted the challenge of high command and the cost in lives that it must sometimes entail. . . . But the 24th Brigade, which knew nothing of the night's drama and had been inching its way through the minefields behind its gapping parties, was clear of them by shortly before 0500 . . . the break-in—the first phase of Operation LIGHTFOOT—had been completed, but 24 hours behind schedule."

Fred Majdalany, *The Battle of El Alamein: Fortress in the Sand* (New York: J. B. Lippincott Company, 1965) pp. 82–98.

Chapter 4

Amphibious Breach

Use

The amphibious breach is a type of deliberate breach specifically designed to overcome antilanding defenses in order to conduct an amphibious assault. Units conduct an amphibious breach when no other landing areas are suitable for the landing force (LF). Bypassing an integrated landing defense is preferred over conducting an amphibious breach whenever possible; however, the commander must always consider whether a bypass would produce additional risks.

Synchronization and teamwork are essential for a successful amphibious breach, which is characterized by thorough reconnaissance, detailed planning, extensive preparation and rehearsal, and a buildup of combat power. One or more subordinate units are specifically tasked to perform the role of support, breach, and assault forces. The amphibious breach is planned at the naval expeditionary force (NEF) level and usually involves a MAGTF with a GCE force of regimental- or division-size.

This chapter is designed to complement information found in Joint Pub 3-02, *Joint Doctrine for Amphibious Operations*; NWP 22-2/FMFM 1-7, *Supporting Arms in Amphibious Operations*; NWP 22-3/FMFM 1-8, *Ship-to-Shore Movement*; and TACMEMO PZ6022-1-94/OH 1-17, *Amphibious Operations in a Mine Environment* (under development). A commander must have a clear understanding of amphibious operations before planning for any type of amphibious breaching operation.

Types of Amphibious Operations

An **amphibious assault** is the principal type of amphibious operation. It involves establishing a force on a hostile or potentially hostile shore and requires the swift, uninterrupted buildup of combat power ashore. Ship-to-shore movement is a critical element of the amphibious assault and breaching operations may be required. An **amphibious demonstration** is conducted to deceive the enemy by a show of force with the expectation of deluding the enemy into a course of action unfavorable to it. An **amphibious raid** is a swift incursion into, or a temporary occupation of, an objective followed by a planned withdrawal. The **amphibious withdrawal** involves the extraction of forces by sea in naval ships or craft from a hostile or potentially hostile shore.

Getting to the Beach

The Navy/Marine Corps concept for over-the-horizon (OTH) operations emphasizes maneuver, deception, and speed and flexibility, both at sea and ashore. Surprise is extremely important to OTH operations. The concept envisions coordinated heliborne and surface assaults to exploit weaknesses or gaps in enemy defenses ashore. A vertical assault can be used to disrupt and fix the enemy while a surface assault force rapidly attacks to penetrate coastal defenses and link up with the vertical assault force.

The commander, amphibious task force (CATF) is responsible for getting the LF from the point of embark to the high-water line of the landing beach. However, the focus of the CATF does not stop at the high-water line; rather, his concern is ship-to-objective maneuver. Breaching obstacles from the surf zone and inland is a very difficult task that requires extensive coordination between the CATF and the commander, landing force (CLF). Tidal range, coral heads, rocks and other natural or manmade obstacles which affect landing craft must be taken into account. Naval mines pose a significant threat to an amphibious task force (ATF).

Understanding the challenge to maneuver that an ATF faces is the first step in understanding an amphibious breach.

Naval Mines

Naval mines utilize both contact and influence fuzing. Influence fuzing can be magnetic, acoustic, pressure, or a combination thereof. They can be moored, placed on the seabed, or float free.

Water Depths

In order to ease C² for mine countermeasures (MCM), zones have been established according to water depth. The zones are—

- Deep water — more than 200 ft.
- Shallow water (SW) — 40-200 ft.
- Very shallow water (VSW) — 10-40 ft.
- Surf zone (SZ) — 0-10 ft.

Mine Countermeasures

MCM are all methods for preventing or reducing damage or danger from mines (Joint Pub 1-02). **Pro-active MCM** prevents the enemy from laying mines. **Enabling MCM** is either active or passive. **Passive MCM** includes all measures taken to minimize the mine threat without attacking the mine itself. **Active MCM** includes physically clearing mines from an area. This is accomplished by minehunting or minesweeping. Just as in landmine warfare, an ATF maneuvering through an area suspected of being mined should locate, mark, and neutralize mines.

Minehunting is the employment of sensor and neutralization systems, whether air, surface, or subsurface, to locate and dispose of individual mines. Minehunting is conducted to eliminate mines in a known field when sweeping is not feasible or desirable, or to verify the presence or absence of mines in a given area (Joint Pub 1-02). Information about mine functioning is disseminated throughout the force to make subsequent minehunting safer. A variety of equipment is available for minehunting (see

appendix C). Sea-air-land (SEAL) teams can also be used for reconnaissance; however, SEAL assets are very limited.

Minesweeping is the technique of clearing mines using either mechanical, explosive, or influence sweep equipment. Mechanical sweeping removes, disturbs, or otherwise neutralizes the mine; explosive sweeping causes sympathetic detonations in, damages, or displaces the mine; and influence sweeping produces either the acoustic and/or magnetic influence required to detonate the mine (Joint Pub 1-02). Minesweeping can be conducted by helicopter and surface ships (see appendix C).

Amphibious Breaching Fundamentals

As in the deliberate breach, the support, breach, and assault forces for an amphibious breaching operation are given specific objectives and detailed control measures for the attack against the obstacle system.

Suppress

Suppression must be effective against enemy fire since the breach force may be exposed for a lengthy period of time. Until a force is established ashore, artillery support will not be available. OAS and NSFS support the breach by suppressing enemy positions capable of interfering with the breach or assault force. As soon as possible, friendly artillery is established ashore to help suppress the enemy.

Suppression may begin with air attacks against enemy command and control centers, radars, or other target acquisition assets. Chokepoints for possible enemy counterattacks should be plotted before the operation during detailed fire support and obstacle planning. The support force should maneuver into the best overwatch position to provide suppression for the breach force. This may require ships to move close inland to provide direct suppressive fire on the enemy.

A heliborne assault force may be utilized to land in areas beyond the obstacle in order to engage enemy forces. If the assault force successfully eliminates the position, it also eliminates direct fires on the breaching element. If the assault does not succeed in securing the position, it still fixes the enemy and reduces the enemy's ability to fire on the breaching element.

Obscure

The availability of smoke for amphibious breach forces is limited. Both OAS and NSFS can provide WP to mask movement. The use of WP will depend upon the need for other types of fire support. Until artillery and mortars are established ashore, the use of smoke may be limited. Natural limited-visibility conditions should be exploited if possible.

Secure

OAS and NSFS is required to isolate and secure the breaching site while lanes are being reduced. A heliborne assault force may be able to bypass beach obstacles, engage enemy forces, and establish blocking positions. However, a heliborne force will not have sufficient assets to engage in a prolonged enemy counterattack.

Reduce

The number of lanes that the breach force creates is determined by METT-T. In order to diminish the enemy's capability to deliver concentrated fire on one site, several lanes should be reduced simultaneously. A minimum of two breached lanes per colored beach is required. Lanes must be wide enough to permit landing craft to land ground breaching assets. The greater the number of breached lanes, the sooner forces can land. It is essential that lanes be quickly marked and widened to allow a rapid buildup of combat power ashore.

Both the naval and ground breach forces are massed for reduction efforts. A variety of reduction techniques should be used to guarantee success and

continue forward momentum. Within the naval breaching force there may be Navy EOD MCM detachments, minesweepers, and SEAL teams. The ground breaching force should have multiple breaching assets such as AAV mounted MK 1s, tanks with mine plows, hand-held mine detectors, and demolitions. Figure 4-1 depicts a potential amphibious breach scenario in which surface minesweepers, airborne minesweepers, landing craft air cushions (LCACs), and MK 1 mine clearance systems are used in conjunction with each other in order to create a breached lane from the shallow water zone through the craft landing zone (CLZ). Explosively breached lanes should be proofed when the risk of live mines exceeds the risk of loss due to enemy fire.

Resupply

Prepositioned emergency supplies are used for resupply of the LF early in the ship-to-shore movement. These supplies are available on-call for immediate delivery to units ashore. Prepositioned emergency supplies are either located on floating dumps or prestaged aboard ships for helicopter transport. These supplies should be tailored to meet the demands required of an amphibious breach.

Supporting Operations

Supporting operations are those operations conducted by forces other than those assigned to the ATF. They are ordered by higher authority at the request of the CATF, and normally are conducted outside the area for which the CATF is responsible at the time of their execution. Supporting operations conducted in the amphibious objective area (AOA) will be coordinated with the CATF. Supporting operations include—

- Military deception.
- Isolation of the landing area by the conduct of interdiction.
- Operations designed to assist in gaining or maintaining air, ground, or naval superiority in the landing area.
- Operations to gather information.

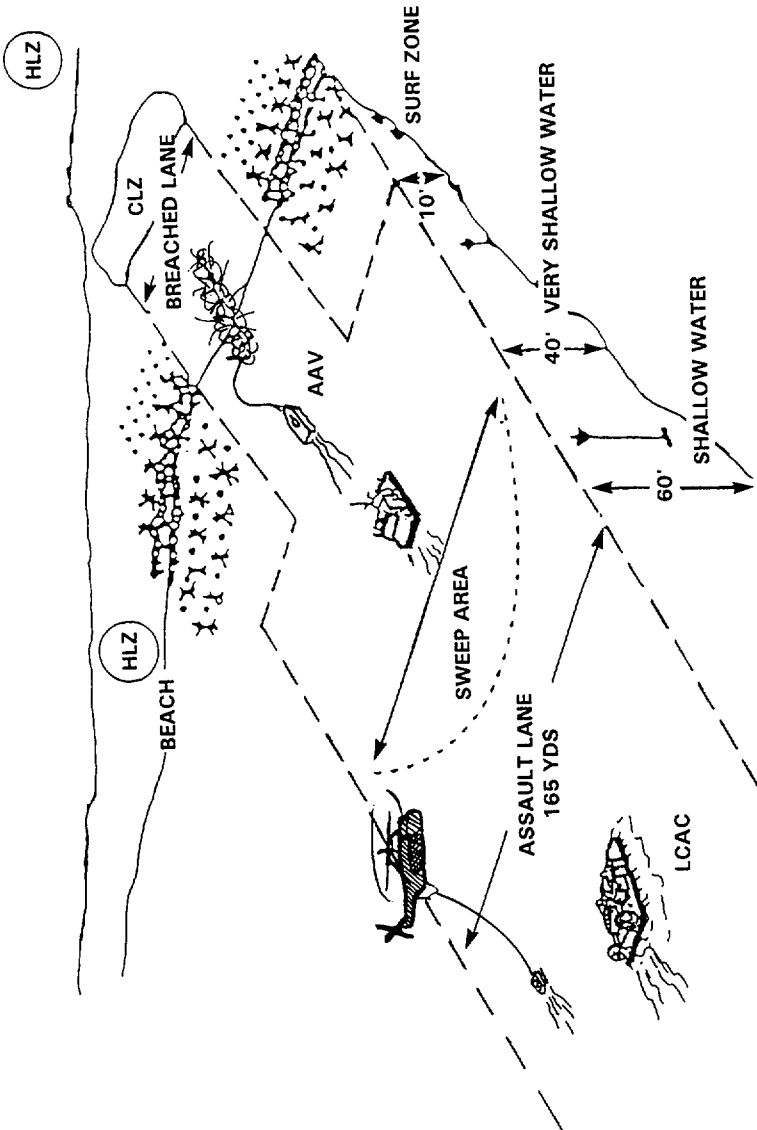

Figure 4-1. Amphibious Breach.

- Special operations designed to disrupt, delay, or confuse the enemy.
- MCM conducted in the vicinity of the intended landing area(s) before the establishment of the AOA.

An advance force is a temporary organization within an ATF that is usually dissolved when the main body of the ATF arrives in the AOA. An advance force may be tasked with conducting the above supporting operations. The extent of enemy defenses, obstacles, and the need for surprise must all be taken into account when deciding to employ an advance force.

Amphibious Assault Sequence

The general sequence for conducting an amphibious assault is planning, embarkation, rehearsal, movement, and assault to accomplish the mission. Consideration for amphibious breaching should be given in each stage of the sequence.

Planning and Task Organization

The success of an amphibious breaching operation depends heavily on intelligence. Planning should begin with an estimate of the situation. Developing the collection plan is a joint effort between the N2 and G2, with reconnaissance efforts concentrating on confirming enemy locations and OBSTINTEL. The N2 should concentrate on obstacles from the sea to the high-water line while the G2 concentrates on obstacles from the high-water line inland. COAs are developed using estimates of the enemy situation and capabilities. A scheme of maneuver for each COA is developed and briefed to both the CATF and the CLF.

After a COA is selected, assets are allocated to the breach, assault, and support forces to ensure that they can accomplish their assigned tasks. Fire control must be planned in detail using simple and well-understood control measures. Specific breaching tasks must be assigned to both the naval and ground breach forces. Plans should include detailed planning

for the staging and movement of follow-on forces and equipment. Task organization should be adjusted as more details of the defense and obstacle system are uncovered.

Doctrinally, the Navy is responsible for the destruction, removal, or marking of obstacles from the sea approaches up to the high-water line. The LF is responsible for obstacle reduction from the high-water line inland. Therefore, an amphibious breach force will consist of both a water breaching element and a ground breaching element, both of which must be controlled by a single breach force commander in order to adhere to the principle of unity of command. The water and land breaching forces should complement each other to provide for continuous forward momentum of the amphibious forces from the shallow water through the surf zone and inland.

As in the deliberate breach, the breaching tenet of mass drives the task organization for the amphibious breach. The breach force should have the bulk of breaching assets and be tailored to counter specific types of obstacles. Assault forces are massed into heliborne and surface assault forces. OAS and NSFS should be massed in the support force to provide necessary suppression. The scheme of maneuver must be synchronized to coordinate the support, breach, and assault forces.

Embarkation

Ground breaching assets must be combat loaded so that they can be off loaded in the first waves of an assault. Assets may be rearranged based on lessons learned from the rehearsal or changes in intelligence. Once forces are underway however, it can be very difficult to rearrange assets.

Rehearsal

Rehearsals are designed to test the plan, readiness of the force, and timing. The rehearsal site should be similar to the actual area (sea and land) and obstacle(s) to be breached. A force should rehearse under the same conditions expected during the actual engagement, including battlefield

obscuration, darkness, and inclement weather. Several contingency plans should also be rehearsed, including possible enemy counterattacks. If intelligence updates become available after the last possible rehearsal, this data must be passed immediately to the affected force elements, especially the breach force.

Movement

The ATF should move to the AOA organized for the amphibious breach. If the ATF or an advance force encounter water obstacles en route, mine countermeasures are used. This may alter the route to the AOA.

Assault

OAS and NSFS should be used to suppress the enemy and cover deployment of the breach and assault forces. The support force executes planned targets on enemy positions. WP is adjusted to obscure the breaching site. The breach forces begin movement once suppression and smoke are effective. Timing is critical, since a high volume of suppressing fire and obscuration can only be sustained for a short duration. Additionally, if a heliborne assault force is used in conjunction with a surface borne assault force, the heliborne force must be reinforced as soon as possible. CATF and CLF must know the progress of the breach in order to decisively commit the balance of the force through the obstacle and build up combat power ashore. CLF informs CATF of LF requirements for units, materials, and supplies during the latter stages of the assault and specifies when they will be required.

Continuing the Attack

After passage through the lanes, the force continues its mission. The obstacle system acts as a chokepoint and danger area even after defenses have been overcome. Lane marking is improved as soon as possible. Additional lanes are constructed to speed the passage of follow-on forces and

existing lanes should be widened. Eventually, obstacles are cleared to eliminate the chokepoint.



Several amphibious breaching operations were conducted during World War II. Many of the same types of obstacles used for antilanding defenses then are the same types used today. The following historical example demonstrates how an amphibious breach was successfully conducted in southern France.

During Operation Anvil in 1944, "Before daybreak on 15 August commando raiders hit the suspected German gun emplacements on the Iles d'Hyeres off Cape Benat, and the Allied 1st Airborne Task Force began its drop into zones around the towns of Le Muy and Le Luc, some ten miles inland from the amphibious landing zones. As the sun rose at 0638 a furious naval bombardment was directed at the larger German guns on the mainland, now obscured in the light haze hanging over much of the shoreline in the early dawn. . . .

"After 0710 minesweepers moved in under the cover of naval fire, clearing boat lanes to within 100 yards of the beaches. In the shallow water stood rows of concrete pyramids and tetrahedrons, most equipped with Teller mines. At 0730 eighteen Apex drones rumbled shoreward to blast clear the last 100 yards for the landing craft. Fifteen drones destroyed as many obstacles . . . By 0758, naval fire support shifted to the flanks of the beaches, and the first waves started shoreward. Three minutes later, the 7th Regimental Combat Team, 3d Infantry Division, struck Alpha Red, and the 15th Infantry drove onto Alpha Yellow. The tank-gapping team at Alpha Red immediately fell into five-foot surf off the beach, nearly drowning out the tank engines. Undeterred, their crews gunned the two engineer tanks up the sand, bulldozing a passage through the railroad embankment behind the beach and clearing a road through a mined, wooded area, all in less than ten minutes. Elements of the 1st Battalion, 36th Engineer Combat Regiment, came in with the first wave on Red, and immediately squads began probing for mines with bayonets and detectors.

"The gapping team at Yellow landed some 1,500 yards to the left of its assigned point and had to wade the single tank through water five feet deep. But once ashore, the vehicle took only a quarter-hour to clear a 1,500 yard path through antitank and antipersonnel mines to a highway, silencing a German antitank gun in the process."

Alfred M. Beck, Abe Bortz, Charles W. Lynch, Lida Mayo, and Ralph F. Weld, *The Corps of Engineers: The War Against Germany* (Washington D.C.: United States Army Center of Military History, 1985) pp. 439–441.

Chapter 5

Assault Breach

Use

The assault breach is a breaching operation used to penetrate enemy protective obstacles and continue the assault through an objective. It will often be performed in conjunction with other types of breaches. Assault breach execution is usually carried out at the platoon and squad level. It may be conducted to support either a mechanized or footmobile assault. A mechanized assault is the preferred technique if the enemy is very weak. However, the commander must weigh the advantages of conducting a mechanized assault against the danger of close-range antiarmor weapons.

Nature of the Assault

Enemy defenses may require the attacker to fight through extensive protective obstacles and fortifications covered by interlocking small arms fires and close-range antiarmor weapons. An assault should be initiated by massing overwhelming combat power at a weak point in the enemy's defense. Once a foothold is gained, the attacker continues the assault by seizing squad- and platoon-sized objectives, clearing infantry trench lines, and destroying bunkers. With each objective, assaulting squads and platoons are likely to encounter protective obstacles and breaching may be required to continue the attack. Maintaining the momentum of the assault is essential to prevent the defender from launching a counterattack against the point of penetration.

Assault Breaching Fundamentals

The decentralized nature of the assault is reflected in the application of the SOSRR breaching fundamentals in the assault breach. The assault force commander allocates engineers, equipment, and demolitions to infantry squads and platoons to provide a breaching capability throughout the force. Maneuver during an assault is usually conducted by platoons and assault breaches are usually made by squads under platoon control. A squad or fireteam within a squad should provide suppressive fire while another squad or fireteam assaults through a footpath breach.

Suppress

Suppression is used during the assault breach to neutralize enemy positions firing on the breaching site and to prevent enemy reinforcements from reaching the point of penetration. Effective suppression during an assault breach, therefore, occurs at two levels. The commander planning an assault should dedicate a force to focus suppressive fire on subsequent objectives. For instance, a commander may use mortars, artillery, AAVs, LAVs, or supporting tanks to fire on the next objective while the infantry assaults. Suppressive fire shifts as the assault progresses. Fire may be shifted based upon the friendly force reaching a specific terrain feature or on some other type of prearranged signal. A second level of suppression is provided by the assaulting force itself. Units encountering obstacles execute immediate action drills to return fire on enemy positions.

Obscure

Smoke is used to help conceal the location of the breach. Using a combination of high explosive (HE) and smoke as the last rounds of an artillery preparation can establish a haze within the objective and help obscure the assault. WP rounds from mortars may be executed on order before assaulting forces reach protective obstacles. If wind conditions are favorable, the support force should establish a smoke line using smoke pots. The assault force should employ hand-held smoke grenades and smoke pots as part of their breaching drills.

Secure

Security is achieved by a heavy volume of fire delivered by the assault force in close overwatch and the support force in far overwatch. The support force focuses on the far side, isolating the breach site from enemy reinforcement.

Reduce

Reduction in the assault breach refers to creating footpaths through protective obstacles, reducing fortifications, and widening lanes to support mechanized forces. The commander should task-organize the breach force with sufficient assets to breach a minimum of one lane per assaulting infantry platoon. Engineers can be massed so that an engineer squad supports an assaulting platoon. Footpaths are breached through protective obstacles while the platoon lays a base of fire.

Resupply

Resupply of critical class V materials, such as small arms ammunition, grenades, and demolitions must be planned. Personnel may be issued additional ammunition to help offset the logistics demand required of assault breaching. However, the combat load must not be so heavy as to be counterproductive, nor does this alleviate the necessity to plan for a rapid resupply of assaulting units.

Planning and Task Organization

Engineers integrated into the assault force provide decentralized, responsive support at the lowest possible level within the assault forces. This is a sharp contrast to the deliberate breach, where the breach force may be under the control of an engineer, and operates as a separate unit. Limited visibility, concentrated direct and indirect fire, and the confusion of assaulting an objective all hamper C². Therefore, engineers supporting an assault force should already be task-organized to the unit they will support.

Engineers can contribute to the assault in four major areas. They—

- Conduct decentralized obstacle reduction to maintain momentum of the attack.
- Reduce fortifications with demolitions, shoulder-launched multipurpose assault weapons (SMAWs), and handtools.
- Widen initial assault breaches to permit mechanized forces to move on or through an objective.
- Hand over breached lanes to follow-on forces for widening and improved marking.

After breaching footpaths through protective obstacles, engineers and infantry assault platoons continue to fight through the defensive position. Engineer squads can split into demolition teams and move with lead infantry squads. This gives the lead squads, which may be clearing a trench line, a dedicated force to neutralize booby traps and destroy enemy fortifications and equipment. Engineer SMAW gunner actions are coordinated with the infantry company assault section SMAW gunners to best employ their assets. After enemy bunkers are neutralized, engineers may be tasked with destroying them along with enemy equipment. When conducting assault breaches in military operations on urbanized terrain (MOUT), engineers may use demolitions to assist clearing teams in gaining entry through walls, doors, floors, and roofs.

Consolidation

The final stage in the assault breach is improving the breached lanes to allow additional forces to penetrate the position and attack the next objective. This is the priority of engineer effort during the consolidation phase. In the aftermath of an assault, forces may be scattered throughout the objective. Consolidation is critical to re-establishing C² as well as effecting casualty evacuation and resupply. A force needs to be able to move freely within the objective without the risk of sustaining mine casualties. Breached lanes are marked and widened as soon as possible. Forces

carrying the fight to the next objective must be able to quickly move through and around protective obstacles and initiate the assault with C² intact. Breached lanes should be handed over to follow-on forces without delay. CSSE engineers within the follow-on forces are usually responsible for improving breached lanes and eventually clearing the obstacle.



The following excerpt demonstrates a successful assault breach which was implemented during a skirmish between French and German forces in World War I. This assault took place near the small town of Seboncourt in northeastern France.

“On October 12, 1918, the French 12th Infantry attacked to the northeast with its 1st and 2d Battalions in assault . . . Diagonally across the regiment’s front ran a strongly-held and heavily-wired German trench sited along a commanding ridge. Two lesser crests lay between the trench and the Seboncourt—Bernoville road, but otherwise there was slight cover.

“The 7th Company . . . became heavily engaged before the other units. Although it reached the German position, it was thrown out by a counter-attack and suffered such heavy losses that it was temporarily eliminated as a combat unit. The remaining three companies reached the last crest west of the German trench, where they were quickly pinned to the ground by heavy fire.

“At this juncture a few men noted a threshing machine . . . and promptly converged on it to take advantage of the slight cover it offered. From their dangerous position behind thresher, a lieutenant and a sergeant saw that the entanglement across the road was made up of portable wire. . . . They raced forward and succeeded in clearing away the wire at this point before the defenders picked them off. Nearby elements of the 5th Company saw the gap, rushed for it, broke through, and cleared a short stretch of German trench on each side.

"This group then continued the advance, leaving only five or six men to keep the gap open. These men were given a French machine gun and a captured German machine gun and ordered to fire to the north in order to assist the 1st Battalion. Meanwhile the captain of the 3d Company, who had noted this success, brought up his two machine guns and opened fire with them. Since his assault platoons were pinned to the ground, he sent a runner to the leader of his right support platoon with a message directing him to move under the cover of the crest toward the thresher, enter the German position and attack northward along the German trench.

"The runner was killed before he reached his destination. Fortunately the platoon leader in question, acting on his own initiative, decided to make the very movement ordered. His platoon passed through the breach, turned north, took the defenders of the trench in flank and rear, and captured two machine guns and 50 prisoners. The assault platoons of the 3d Company then advanced, and captured all of the trench in their zone. This action allowed the 2d Company to capture the position in its front soon afterward."

U. S. Marine Corps, FMFRP 12-2, *Infantry in Battle* (Washington, D.C.: Headquarters, U. S. Marine Corps, 1988) pp. 309-310.

Chapter 6

Covert Breach

Use

The covert breach is a breaching operation used to overcome obstacles without being detected by the enemy. It is used when surprise is essential to infiltrate through enemy obstacles and fortifications, and when limited visibility and terrain present the opportunity to reduce enemy obstacles without being seen. Through surprise, the commander conceals his capabilities and intentions and creates the opportunity to position support and assault forces to strike the enemy unaware or unprepared.

The battalion is the principal unit to conduct a covert breach. The covert breach requires a level of detailed planning, intelligence collection, and command and control that is normally beyond the capability of a company. A regiment is usually too large to maintain the level of stealth necessary to conduct a covert breach. The covert breach is ideally suited for footmobile forces.

Covert Breaching Fundamentals

The covert breach applies some characteristics of in-stride, deliberate, and assault breaching operations; however, the planning and execution of SOSRR breaching fundamentals are significantly different. The commander still task-organizes the unit into support, breach, and assault forces. However, the support force does not usually provide suppressive fire until the initiation of the assault or in the event that the breach force is detected. Security is achieved through stealth. Combat forces are positioned to observe the breaching site to provide the breach, assault, and

support forces with early warning of enemy detection. The need for stealth outweighs the need for speed during obstacle reduction. A force executing a covert breach should mark, secure, and guard the breached lanes until the assault.

Suppress

Suppression is always planned for the covert breach. Since surprise is essential, suppressive fire should only be executed when—

- The breach force is discovered in mid-breach.
- The breach force is close to the obstacle and must expose itself in order to reduce the obstacle.
- Lanes are open and the assault is initiated.
- The breach force completes lane reduction and detonates charges to clear obstacles, signaling direct and indirect suppressive fire to support the assault force.

Obscure

Obscuration is a necessary condition for covert breaching. Normally, natural obscuration, such as darkness, snowfall, rain, or fog, is used during the covert breach. Utilizing artificial smoke to further reduce visibility must be done with great care. A sudden application of smoke on a breaching site may attract enemy attention to the breaching attempt. However, smoke must be planned for in case the breaching attempt is discovered. Recurring interdictory artillery fire and smoke on several potential breaching sites can build complacency over a period of days. It trains the enemy to accept the necessary condition of obscuration without abnormal alertness or suspicion of covert breaching attempts.

Secure

Security is provided by a portion of the breach force that is organized into a security team. The function of the security team is to cover the withdrawal of the reduction team if it is discovered. If the obstacle is protected

by outposts, the security team may silently eliminate them before the breach is attempted. The security team may also establish ambushes to guard against enemy patrols and engage them at a distance from the breaching effort.

Deception can also play a major role in securing a covert breaching effort. If a feint or demonstration attack is launched against another defending unit, it can attract attention away from a covert breach. Securing the passage of the force is accomplished by guarding the lanes once they have been completed. This can be done by a security force on the enemy side of the obstacle, but it generally consists of establishing a well-hidden observation post (OP) to watch the lane until the attack. The OP provides warning if the enemy discovers the lane.

Reduce

The obstacle is reduced by using silent techniques such as—

- Marking mines.
- Cutting wire.
- Cutting down the sides of an antitank (AT) ditch with shovels.
- Setting explosive charges and waiting to detonate them at a pre-determined signal.

The number and width of lanes depends on the composition of the assault force that will pass through the obstacle. There should be a minimum of one lane for each footmobile assault platoon and a minimum of two breached lanes for a battalion-sized mechanized force. It is important to have a carefully arranged lane marking and reporting system. If hand emplaced charges are used to clear a lane, then markers may be emplaced at the same time. Such markers must be undetectable by the enemy yet visible to friendly forces. Lane marker information must be accurately conveyed to follow-on units. Guides from the breach force are used to show follow-on units the location of breached lanes.

Resupply

Pre-staging supplies in forward areas near breach sites makes them readily available for issue. Personnel may be issued additional supplies, however, the combat load must not be so heavy as to be counterproductive. One method of resupply could be to silently pass forward demolitions or marking devices to a breach force during a covert breach. There is still a need to plan for a rapid resupply. In the event that the covert breach is detected and a transition to a different type breach is required, large quantities of class V will be expended.

Planning and Task Organization

Reconnaissance is the key to the success of a covert breaching operation. Reconnaissance determines the types and number of obstacles, concealed routes for movement, and the best locations for the breach, assault, and support forces. The need to maintain silence increases the time required to conduct the breach. The breach force must plan to begin reducing obstacles early enough to accomplish the breach in time for the assault.

Plans must be prepared to transition to another type of breach if the covert breach is detected. The breach, assault, and support forces must clearly understand the criteria for transitioning to another type of breach. The transition to another type of breach from a covert breach should be a well-rehearsed immediate action drill.

The size and organization of the breach force depends on the mission the covert breach supports. Because surprise and undetected movement are critical, only the breach force consisting of breach and security elements are forward at the obstacle. The assault force is held back until the lanes are open. Once lanes are open, the breach force guides the assault force through.

Preparing

Preparation for a covert breach involves the same procedures as other breaching operations. However, it becomes more critical in a covert breach since synchronization of SOSRR breaching fundamentals can be based on a primary and/or a contingency plan. Rehearsals are critical and should include all key leaders of the combined-arms team. Furthermore, they should be staged against expected obstacles in similar terrain and conditions. The following scenarios should be included: covert reduction undetected, covert reduction detected (especially fire control measures), and transition to another type of breach.

In the assembly area, the force distributes and prepares breaching assets: wire cutters, cloth to muffle the sound of wire being cut, probes, mine markers, lane marking material, explosives, and additional breaching equipment for a failed covert breach. Lane marking, signals, and code words should be reviewed to ensure that all personnel are familiar with them. Prior to conducting the breach, the commander should check equipment and ensure that subordinates know the plan and the immediate action drills to perform if they are detected.



One of the most successful covert breaches took place against what was thought to be an impregnable fortress.

"In the spring of 1940, the defenses of the Kingdom of Belgium, and with Belgium, the northern flank of France, depended almost entirely upon a belt of ultramodern concrete fortresses along the border that Belgium shared with Germany. The greatest of these, in both strength and importance, was Eban-Emael. Covering almost four square kilometers, the fort, with its artillery, antitank guns, and machine guns, dominated the terrain around it and made an infantry assault against it unthinkable. Artillery or air bombardment would be equally futile—the bulk of the fortress was located deep underground. On May 11, however, the Germans took this fortress, not with a division or even a regiment, but with a battalion of combat engineers acting in concert with a gliderborne engineer platoon.

"The German heavy artillery fired, not in a vain attempt to destroy the fort, but to create craters in the flat terrain covered by the field guns in their armored cupolas. Other German guns fired at the cupolas themselves, again not to destroy, but to suppress the fire of the occupants. When darkness fell, the German engineers crossed, in rubber boats, an artificial lake that separated them from Eban-Emael. Using the shell holes made by their own guns for cover, they crept forward.

"At dawn, flamethrowers sent streams of burning oil onto the embrasures from which the machine guns responsible for the close defense of the fort were expected to fire. Reeling from the heat and blinded by the smoke, the machine gunners failed to see the small team that had rushed forward with a huge shaped charge. A few seconds later, the charge went off, punching a hole in one of the main cupolas of the fort. Other explosions followed. One by one, the steel turrets that housed the teeth of Eban-Emael were destroyed. By the end of the morning, the fort was defenseless and surrounded."

Bruce I. Gudmundsson, *Stormtroop Tactics: Innovation in the German Army, 1914–1918* (New York: Praeger Publishers, 1989) pp. xi–xii.

Chapter 7

Breach Lane Marking

Marking Systems

A good marking system allows a force to quickly pass through a breached lane thereby maintaining momentum, gives confidence in the safety of the lane, and helps prevent casualties. Whether marking a breached lane for land operations or through the surf zone, there are two critical components to a lane-marking system:

- Marking device.
- Marking pattern.

Marking Device

Currently, the Marine Corps uses the minefield marking kit, TAMNC B1320, for marking breached lanes through obstacles. Buttoned-up vehicle crews must be able to see lane markings. Vehicles which have infrared sights can see heat sources through smoke. Flares, bicycle flags on 6-foot nylon poles, highway cones, engineer stakes with engineer tape, and/or chemical lights can be used to mark breached lanes. Large air panels make high visibility far recognition and approach markers.

North Atlantic Treaty Organization (NATO) Standard Markers. NATO standard markers are arrow shaped signs painted red and white. Red indicates danger and white indicates the safe or cleared area. The white portion of the NATO marker must point inward toward the breached lane (see figure 7-1). NATO markers are placed at right angles to the direction of travel. Units may fabricate NATO markers if they are not available. Markers must be large enough to be visible from 50 meters under

most daylight conditions and have a field life of 60 days. Marking devices should be converted to NATO standard as early as possible.



Figure 7-1. NATO Standard Marker.

Center Lane Marker. The center of a two-way lane can be marked by placing the red side of NATO markers back to back (see figure 7-2) and placing them down the center of the breached lane.

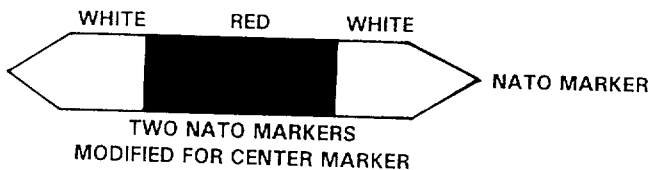

Figure 7-2. Center Lane Marker.

Night Marking. NATO uses white or green lights to illuminate markers at night. Entrance and exit markers are marked with either two green or two white lights placed horizontally so that they are clearly visible (see figure 7-3). One white or green light is used on funnel and handrail markers (see figure 7-4). The commander decides whether the light is placed on top of the NATO marker or placed so that it illuminates the markers. Lights must be visible from a minimum of 50 meters under most conditions. The tactical commander should decide whether the route markers are illuminated on one or both sides. Light sources for marking at night must have a continuous life of 12 hours.

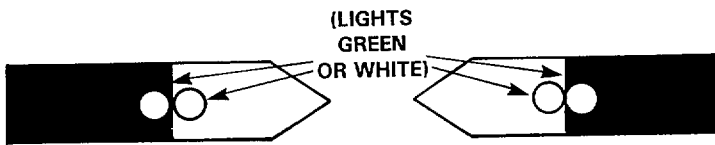

Figure 7-3. NATO Entrance/Exit Marking for Night.

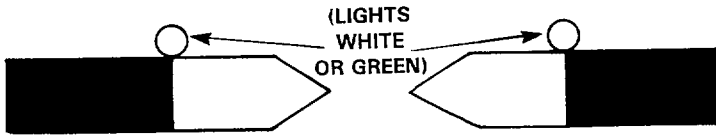

Figure 7-4. NATO Left/Right Handrail Marking for Night.

Marking Pattern

No matter what marking devices are used, the marking pattern should remain the same. This helps ensure that everybody, including attachments and adjacent units, can recognize breached lanes.

Far Recognition Marker. A far recognition marker is highly visible and helps identify the location of a breached lane from a great distance. Several far recognition markers may be required. It is primarily used when passing forces through a lane where distance, visibility, or terrain do not allow direct observation of the final approach marker. The far recognition marker indicates the point at which forces should begin changing their formation for lane passage. A far recognition marker may be used for two breached lanes if the lanes are 200 to 400 meters apart. When a far recognition marker serves more than one lane or there are limited visibility conditions, guides should be posted to direct traffic.

Final Approach Marker. A final approach marker is a highly visible marker that helps identify entrance funnel markers from a distance. It is located between the far recognition marker and the entrance funnel markers. When possible, the final approach marker should be different from far recognition markers.

Entrance Funnel Markers. Entrance funnel markers are placed in an arrowhead shape and guide the lead element of a force to a breached lane.

Entrance Markers. Entrance markers indicate the start and width of a breached lane. Identification of the entrance markers is essential to prevent individuals or vehicles from going into an obstacle such as a minefield. They should be different from handrail markers so that individuals know when they are first entering a breached lane.

Handrail Markers. Handrail markers are placed along the length of a breached lane. Lanes should have at least a left handrail. Drivers use entrance markers to gauge the breached lane width when only the left handrail is marked. As the operation progresses, lane marking should be improved to include both left and right handrails.

Center Lane Markers. Center lane markers are placed along the center of a breached lane. They are used when there is two-way traffic through a lane.

Exit Markers. Exit markers indicate the end of a breached lane. The exit identifies the point at which movement is no longer confined to the lane path. Exit markers should be different from handrail markers so that individuals know when they are no longer in the breached lane. They may be the same as the entrance markers. Exit markers also indicate the width of the breached lane. This visual reference is critical when only the left handrail is marked.

Exit Funnel Markers. Exit funnel markers help prevent the premature deployment of the passing force into a combat formation before they are

safely outside the obstacle. They become the entrance funnel markers for returning traffic.

Far Side Final Approach Marker. A far side final approach marker helps returning traffic to clearly identify the lane from their side. It should be centered on the lane and placed approximately 200 meters beyond the exit for a mechanized force or 30 meters beyond the exit for a footmobile force.

Traffic Control Guides

Guides placed for traffic control should know the—

- Traffic control plan
- Azimuth and distance to the breach lanes(s).
- 8-digit grid coordinate of the lane if it is entered into the global positioning system (GPS).
- Level of lane marking and type of markers used.

Levels of Lane Marking

There are three levels of marking for breached lanes:

- Initial.
- Intermediate.
- Full.

Initial Lane Marking

The initial lane marking pattern is emplaced by the breach force immediately after the lane is reduced and proofed. Initial lane marking is limited to those markings needed to pass assault forces through a breached lane (see figure 7-5). At a minimum it should have entrance markers, left handrail markers, and exit markers.

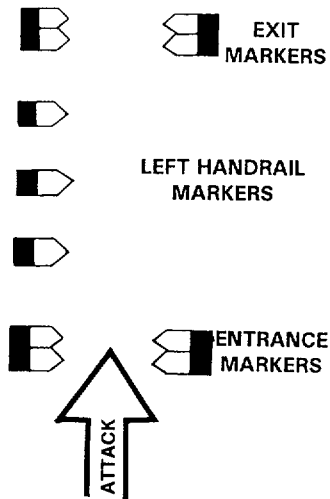

Figure 7-5. Initial Lane Marking.

First Emplaced. The entrance, left handrail, and exit markers should be the first markers to be emplaced (see figure 7-5). The entrance markers are spaced the width of the lane and placed at the lane's entrance point. As a guide, left handrail markers are placed at 15 meter intervals for mechanized forces and 5 meter intervals for a footmobile forces. However, intervals between markers will vary based on terrain, visibility, and available markers. Exit markers are spaced the width of the lane and placed at the end of the reduced lane.

Second Emplaced. Time permitting, the final approach marker and entrance funnel markers are the next to be emplaced (see figure 7-6). The assault force does not have to wait until the final approach and funnel markers are in place before passing through the lane. Traffic control guides are left to make it easier for follow-on forces to maneuver through the lane. The final approach marker should be centered on the lane and placed at least 200 meters from the lane entrance for a mechanized force and 30 meters from the lane entrance for a footmobile force, subject to

change based on the terrain and visibility. Funnel markers should be placed at 15 meter intervals for a mechanized force and 5 meter intervals for a footmobile force.

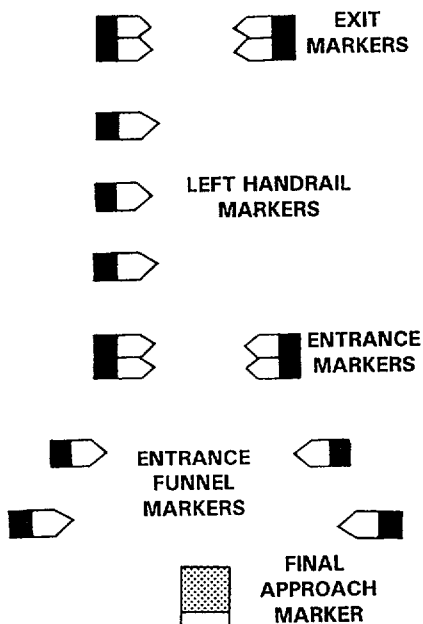

Figure 7-6. Final Approach Marker and Entrance Funnel Markers.

Intermediate Lane Marking

Initial lane marking should be improved to intermediate lane marking as soon as possible. Intermediate lane marking has two goals: to assist in the passage of larger, more distant forces, and to provide marking for two-way, single-lane traffic. Intermediate lane marking builds on the initial lane pattern by adding far recognition markers, right handrail markers, exit funnel markers, and far side final approach markers (see figure 7-7). To speed the passage of follow-on forces, right handrail and far recognition markers should be the first markers emplaced.

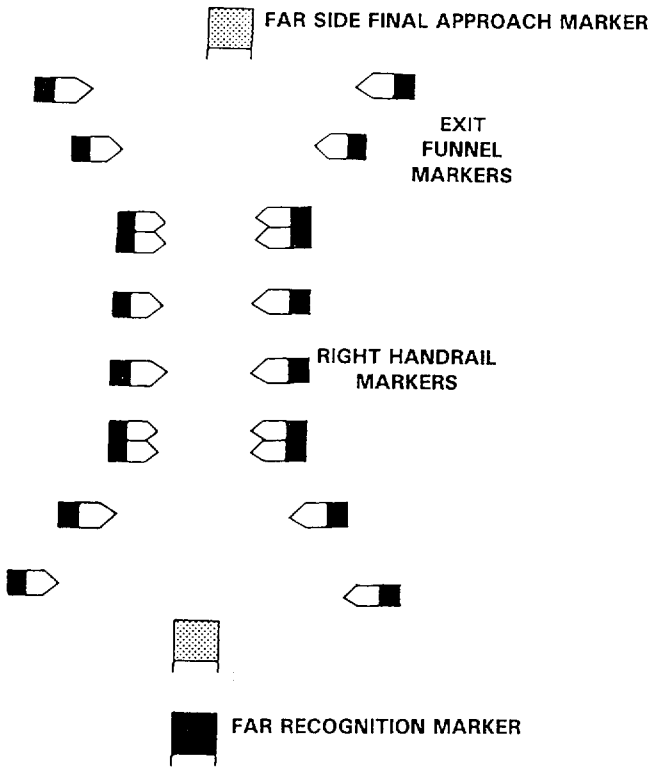

Figure 7-7. Intermediate Lane Marking.

Full Lane Marking

Full lane marking is normally not part of an initial breaching operation. It involves expanding the width of the lane for two-way traffic and emplacing center lane markers to ensure that the marking pattern is adequate for two-way traffic. Full lane marking should always be used when marking a lane through obstacles along a major supply route or passage lane. The full lane-marking pattern has three entrance and three exit markers (see figure 7-8). This indicates a two-way traffic lane. Forces should always

use the right lane when there is two-way traffic. In the full lane marking pattern, funnel markers extend out from the entrance and exit markers on the right side only.

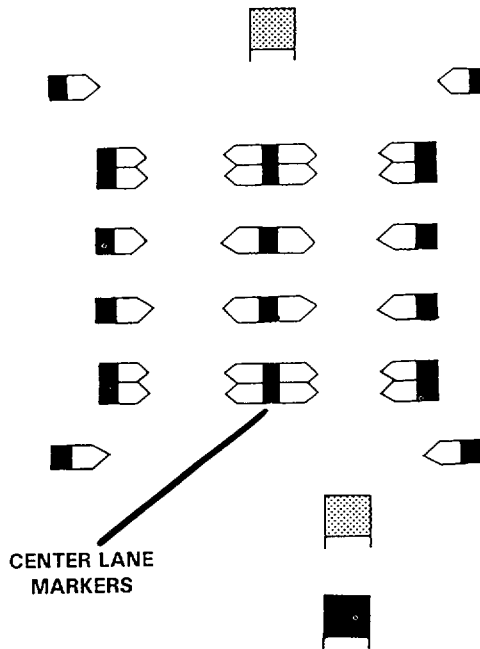

Figure 7-8. Full Lane Marking.

Standardization Agreement (STANAG) 2889

STANAG 2889 outlines the established NATO breached lane-marking pattern. Regardless of the marking device used, the lane entrance point, exit point, and left and right handrail must be marked. The entrance and exit of a lane must be different from other markers and handrail markers cannot be placed at intervals greater than 30 meters.

Intermediate Lane Marking

Figure 7-9 illustrates how the NATO markers are used for an intermediate lane marking pattern. Two NATO markers are used at entrance and exit markings to make them distinctly different. One NATO marker is affixed to each funnel marker and to each left and right handrail marker.

Full Lane Marking

For a full lane-marking pattern, the center of the lane is marked and directional arrows should be placed to clearly identify lane traffic direction (see figure 7-10). A barbed wire or concertina fence (one strand minimum) is laid 1 meter above the ground to connect funnel, entrance, and handrail markers and exit pickets. The minefield marking kit does not contain the long pickets and barbed wire necessary to emplace the full NATO standard marking.

Night Marking

Figure 7-11 illustrates the NATO standard marking for limited visibility conditions. (See page 7-13.)

Breach Lane Marking for Amphibious Operations

Marking breached lanes is even more difficult at sea than on land. Ships can provide direction to landing craft and AAV commanders to help them keep on the correct course. Extensive use is made of GPS. During the initial stages of an amphibious breach, however, breached lanes will be narrow and the chance of straying outside of the reduced lane may be great. The seastate and battlefield conditions can further complicate this matter. A system of buoys may be used to mark breached lanes through the surf zone. Standard identification flags, lights, markers, and signals for amphibious operations can be found in NWP 22-3/FMFM 1-8. Standard markers could be adopted for showing cleared sea lanes. The first unit that is capable must mark cleared areas for landing craft and AAVs by whatever means are available.

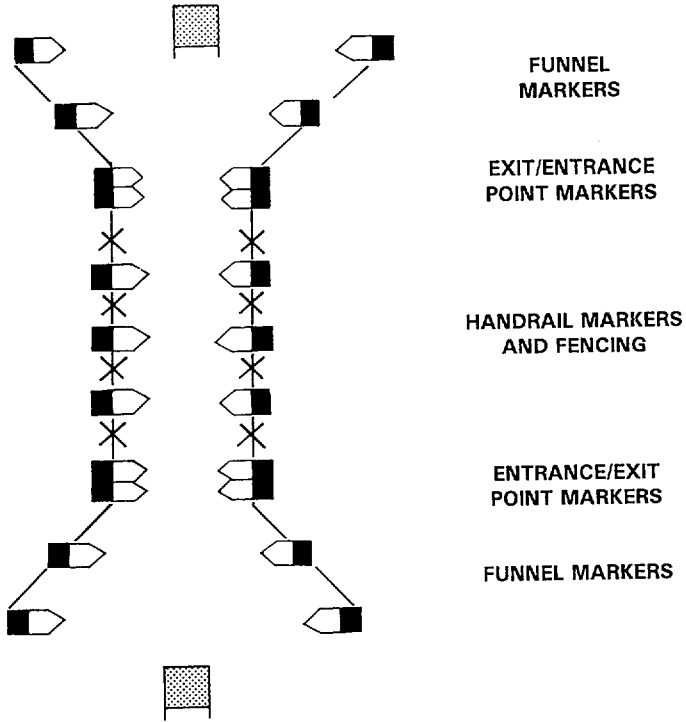

FUNNEL MARKERS

EXIT/ENTRANCE POINT MARKERS

HANDRAIL MARKERS AND FENCING

ENTRANCE/EXIT POINT MARKERS

FUNNEL MARKERS

LEGEND

-  HANDRAIL MARKER
-  ENTRANCE/EXIT MARKER
-  BARBED WIRE FENCING
-  FINAL APPROACH MARKER

Figure 7-9. NATO Intermediate Lane Marking.

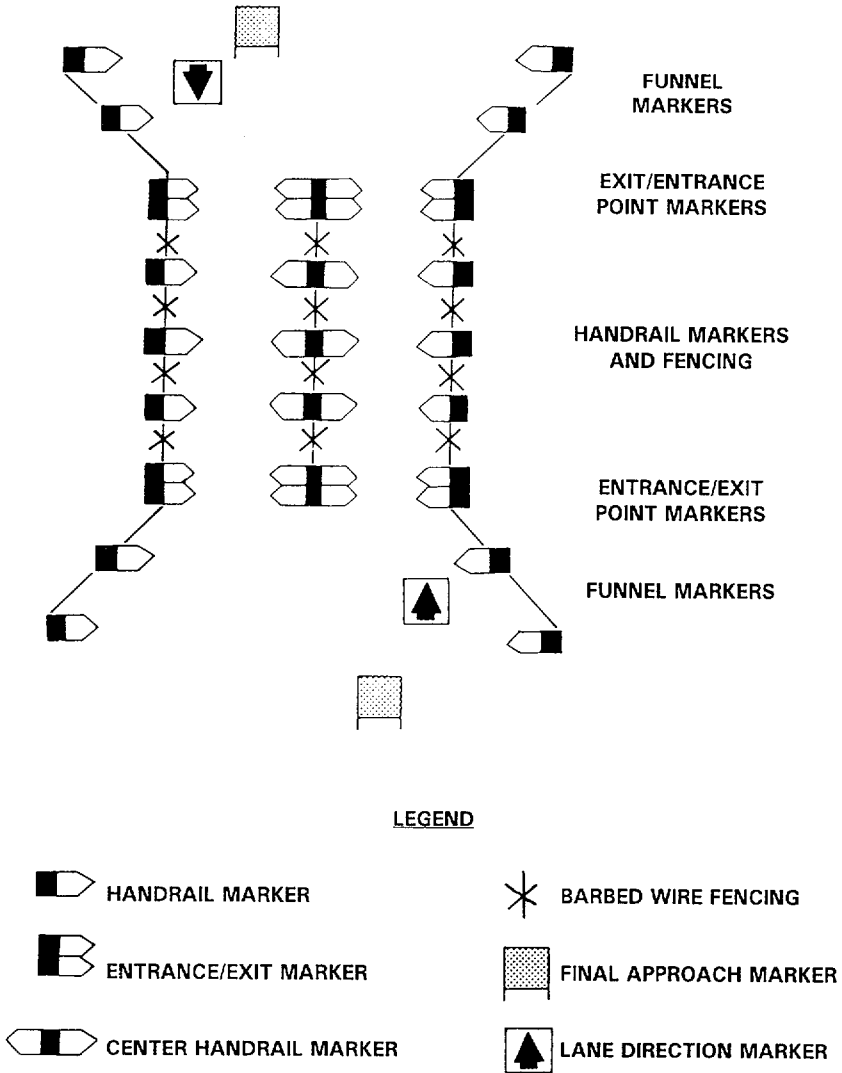

Figure 7-10. NATO Full Lane Marking.

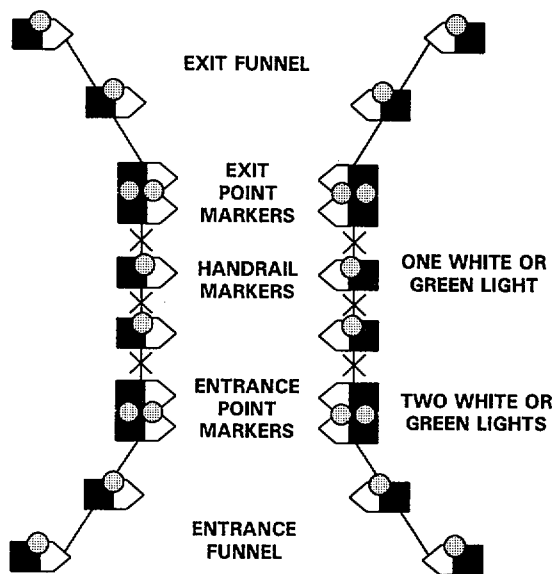

Figure 7-11. NATO Marking for Limited Visibility.



Breach lane marking is critical and can make the difference between success or failure.

During the breakout from the Anzio beachhead in 1944, "... engineers completed most of the mine-clearing during the night of 20 May, but they had to wait to remove wire and to mark gaps which would disclose the direction of the corps attack. On the night of 22 May the engineers removed the wire from the gaps and marked each lane with tracing tape and luminous markers. The breakout was a complete success."

Beck et al, *The Corps of Engineers: The War Against Germany*, p. 199.

(reverse blank) 7-13

Chapter 8

Breach Training

Necessity

Training is necessary to synchronize support, breach, and assault forces for successful breach execution. Leaders should assess the ability of their units to conduct combined-arms breaching operations. A leader should look at all the available information that impacts on the unit's ability to conduct breaching operations. Key sources for evaluating unit proficiency are—

- Individual training standard (ITS) results.
- Personnel turnover.
- Marine Corps Combat Readiness Evaluation System (MCCRES) results.
- New equipment training.
- Gunnery and weapon qualification results.
- Training briefings.
- Previous after-action reports available in the Marine Corps Lessons Learned System (MCLLS).

Combined Arms

Breaching is a combined-arms operation. Standardized breaching actions should be developed and used throughout the MAGTF, particularly in the GCE. A change in the habitual association of combat units and their combat support or combat service support units affects the training proficiency of the total combined-arms force. The GCE commander must keep current on the training status, not only of his infantry, but also of the engineer, armor, field artillery, and other units that support the force. With the completion of a breach training assessment, the commander prioritizes

breaching operations training in long-range and short-range planning calendars.

Breaching Operations Task List

A breaching operations task list should be developed which maps the critical tasks that must be performed at all levels of a breach. It should be the focus for developing progressive training goals. Company and platoon commanders can use the task list to form the foundation for individual training and can be used as the basis for evaluating unit proficiency, to include attached and supporting units.

The breaching operations task list should illustrate crucial regimental, battalion, company, and platoon tasks for a given operation. For the in-stride breach, training emphasis should be at company and battalion levels. Regiment and division level training become more critical for the deliberate breach.

A commander evaluating a company's ability to be a support force might evaluate the following tasks: employment of direct supporting fire, movement to contact, and immediate action drills on contact. Small unit leaders should continuously assess individual skills and provide feedback which will be incorporated into training.

Breaching Rehearsals

Breaching rehearsals are essential to ensure a successful breaching operation. There are four types of rehearsals that can be used for breach training:

- Back brief.
- Sand table.
- Walk through.
- Full-scale.

Each type of rehearsal reflects an increase in realism. Rehearsals should take place on the same type of terrain and obstacles that are expected during an actual mission. However, there is a direct relationship between the amount of breaching rehearsal realism and the amount of time, materials, and manpower required to conduct the rehearsal. Commanders must balance the trade-offs.

Back Brief

The back brief rehearsal is an event that occurs after an operation order (OPORD) brief. Subordinates repeat to the commander what he expects them to do and why they are to do it. They identify all specified and implied tasks and give their restated mission. During the back brief subordinates should address—

- Commander's intent.
- Concept of the operation.
- Their role in the scheme of maneuver.
- Timing to complete tasks.

This rehearsal should include all key staff officers. The primary advantages of a back brief rehearsal are saving time and clarifying the commander's intent.

Sand Table

A sand table rehearsal is the acting out of friendly and enemy actions based on the scheme of maneuver and estimate of the situation. Participants rehearse their actions by moving something that represents their unit on a sand table. While acting out the plan, participants talk through their missions, critical tasks, actions, decisions, and their coordination with adjacent and higher units. Staff officers interject critical unit-level actions and tasks as the scheme of maneuver is acted out. Since all participants are acting out their part of the scheme of maneuver, commanders can identify problems and disconnects in synchronization more clearly on a sand table.

Walk Through

A walk through rehearsal is the acting out of the scheme of maneuver using movement based on the assets employed during the attack. Participants communicate with the same equipment they would use during the attack and make decisions required to execute the breach. Participants actually go through the motions, thereby rehearsing the finer aspects of synchronization, C², and subunit actions. Anticipated enemy actions and reactions are very important in walk through rehearsals. This rehearsal technique is more difficult to orchestrate than the back brief or sand table; however, it is the optimal balance between resource constraints and realism. Successfully mastering a walk through rehearsal should be the minimum goal for all units.

Full-Scale

During a full-scale rehearsal, participants use real-time movement over the actual or similar terrain. Understanding the scope of the full-scale rehearsal is important. A mix of rehearsals is possible. The commander could deem one unit's task to be more complex and critical than other units' tasks. For example, during a deliberate breach, the commander determines that the actions of the breach force are critical to mission success. The commander could have the breach force conduct a full-scale rehearsal while the support and assault forces conduct a walk through rehearsal. At every level, units replicate the actions they should take under realistic conditions. The full-scale rehearsal is the most resource intensive, but it provides the most realistic training.

Rehearsal Principles

Regardless of the event or task to be rehearsed or the type of rehearsal used, eight principles are universal for conducting effective rehearsals. They are—

- Support the scheme of maneuver and commander's intent.
- Provide clear tasks.
- Conduct combined-arms rehearsals.
- Determine key participants.
- Enforce standards.
- Provide feedback.
- Complement the preparation phase.
- Instill confidence.

Applying these principles toward breaching rehearsals provides the commander with the basic framework for planning and executing successful breaching operations.

Conducting Training Exercises

The commander and his staff should plan, conduct, and evaluate training exercises required for breaching operations. Training should be a logical progression from the individual up to the MAGTF level. Breaching skills should be mastered at the small-unit level before conducting large scale field exercises (FEXs). Leader training must be conducted to ensure effective coordination between units. Units need to conduct map exercises, tactical exercise without troops (TEWTs), FEXs, and combined arms exercises (CAXs) to ensure proper breach training.

Map Exercises

The commander executes map exercises with the same participants and expands training, to include consideration of specific terrain, obstacles, and spatial relationships between elements. Leaders represent their units with symbols or figures and war-game the breaching operation, considering different possibilities, outcomes, and solutions.

TEWT

The commander conducts a TEWT as a preliminary field exercise. During the TEWT, leaders confirm the effects of terrain and weather on a breaching operation. They walk through all types of breaching operations, confirming the locations and actions of the support, assault, and breach elements. The TEWT gives leaders an excellent appreciation of the terrain considerations for executing critical collective tasks such as perform reconnaissance, provide suppressive fire, or assault enemy positions.

FEX

FEXs for the in-stride breach should challenge subordinate units with a variety of lightly defended or undefended obstacles. Subordinate commanders must be required to execute breach action drills against a variety of obstacles with little or no OBSTINTEL. This reinforces the rapid and accurate decision making required of the battalion and company in choosing the best means of obstacle reduction. Deliberate breaching FEXs should also test the force against a variety of obstacles. However, OBSTINTEL should be relatively detailed and timely to allow the force to configure and rehearse for the specific enemy and obstacle system.

CAX

A CAX is the ideal tool for simultaneously training all individual and collective skills required to successfully conduct breaching operations. It provides leaders an excellent opportunity to train on synchronizing the full range of critical collective tasks involved in a breaching operation. The CAX provides the commander with the chance to integrate breach training into an overall offensive operation and can include one or more types of breaching operations.

A CAX should have enough flexibility so that leaders are required to make the same hard decisions they will be required to make in combat. For instance, the lead company in a battalion in-stride breach should not be limited to one MICLIC which the commander knows he is to use against the one minefield in his lane. Instead, each company should be organized with several obstacle-reduction means and should be faced with several types of obstacles. Breaching realism is maintained by ensuring that enemy obstacles are emplaced according to the established enemy doctrine. Above all, the leader must make the decision, with the scenario providing the information he needs.



Confucius once said, "I hear, and I forget; I see and I remember; I do, and I understand." (*The Log*.) Failure to adequately train can lead to situations such as the one described below.

In 1943, the Germans laid extensive mines and explosives as they withdrew through the Kasserine Pass in Tunisia. The American engineers "... were as ill prepared as the infantry for mine warfare, although they had responsibility for mine laying and mine clearing. One engineer company commander, who 'had never seen a German mine, picture, or model before entering combat in Tunisia' had to rely on one noncom, who had attended a British mine school in the theater, to train company officers and key men only a few days before his unit encountered its first live minefield."

Beck et al, *The Corps of Engineers: The War Against Germany*, p. 100.

(reverse blank) 8-7

Appendix A

Breaching Plan Appendix

CLASSIFICATION

Copy no __ of __ copies

Issuing headquarters

PLACE OF ISSUE

Date/time group

Message reference number

APPENDIX 15 (Breaching Plan) to ANNEX C (Operations) to Operation
Order _____

Ref:

Time Zone:

1. SITUATION

- a. Enemy Forces. (Refer to Annex B (Intelligence) and current INTSUM. Describe enemy obstacle capability and probability of employment.)
- b. Friendly Forces. (Note higher, adjacent, and supporting forces involved in the operation.)
- c. Attachments and Detachments. (Refer to Annex A (Task Organization).)

(Page number)

CLASSIFICATION

CLASSIFICATION

d. Assumptions. (State any assumptions on which obstacle breaching planning is based.)

2. MISSION

(State the mission to be accomplished by obstacle breaching operations.)

3. EXECUTION

a. Concept of Operations. (Summarize the intended course of action for obstacle breaching operations.)

b. Tasks. (In separate numbered subparagraphs, assign breaching tasks and responsibilities to each appropriate unit.)

c. Coordinating Instructions. (Include coordination and control measures applicable to two or more units.) The marking system should be well defined to include the location of traffic control guides and traffic priority.

4. ADMINISTRATION AND LOGISTICS

(Refer to Annex P (Combat Service Support). Provide a statement of the combat service support requirements for obstacle breaching operations including resupply.)

(Page number)
CLASSIFICATION

CLASSIFICATION

5. COMMAND AND SIGNAL

(Refer to Annex K (Communications-Electronics) and include any special instructions.)

/s/ _____

(Page number)
CLASSIFICATION

(reverse blank) A-3

Appendix B

Fielded Equipment and Techniques for Land Operations

This appendix contains information on breaching equipment which has been or is in the process of being fielded to the Fleet Marine Force. The variety of reduction techniques is virtually unlimited and depends on initiative and innovation. Many techniques involve common hand-tools such as shovels to knock down the sides of AT ditches, wire cutters to cut barbed wire, and axes and chain saws to cut logs and trees. Commanders should always be aware of and capitalize on the simple ways to get through obstacles.

Current information on quantity and location of major end items may be obtained by using the logistics management information system (LMIS) or by contacting the Program Manager Engineer Systems, Marine Corps Systems Command, Quantico, Virginia, at DSN 278-2242; commercial (703) 784-2242, or Program Manager Ground Weapons at DSN 278-2137 or commercial (703) 784-2137.

BALLISTIC PROJECTILES

Ballistic projectiles have proven effective in neutralizing obstacles in certain situations. Rifle, machine gun, and cannon projectiles can be used against thin walls and mines that can be located. A tank's main gun and the SMAW are also effective.

BOMBING

Bombs have been used since World War II to reduce obstacles with mixed results. Bombing can reduce some obstacles; however, it requires extreme accuracy and can result in making large craters strewn with debris, thereby making the area impassable to vehicles. While not the preferred method, bombing is an obstacle reduction option available to commanders. See appendix E, pages E-12 through E-19, for a summary of static bomb tests performed in 1944. These tests were conducted to find a technique for breaching beach and underwater obstacles. Although conducted over 50 years ago, the information should not be forgotten.

MANUAL EQUIPMENT AND TECHNIQUES

Assault Ladders—Folding assault ladders constructed from metal or wood can be carried on vehicles or by individuals. Figure B-1, shows an example of a steel folding ladder. The assault ladder is useful for passing individuals over gaps, walls, wire, and into buildings.

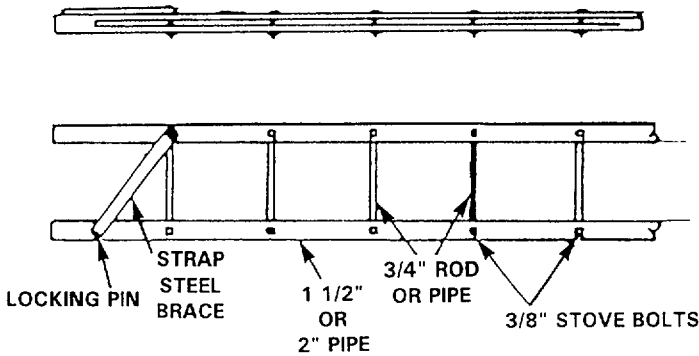

Figure B-1. Assault Ladder.

Bolt Cutters—After an area of wire has been cleared of mines and booby traps, bolt cutters can be used to breach wire. To reduce noise during a covert breach, cloth can be wrapped around the wire where it will be cut. The wire cutter then cuts part way through the wire. The wire is then bent back and forth until it breaks. Wire should be staked or tied down to prevent it from springing back and closing the breach.

Explosives—Surface-laid mines can be reduced by manually placing blocks of explosives next to them. These blocks can be either pre-primed with fuzes or attached in a line main and detonated. Other obstacles such as tetrahedrons, dragons teeth, and hedgehogs can also be reduced by using military demolitions such as C-4 or trinitrotoluene (see FM 5-34/FMFRP 13-5, *Engineer Field Data*, or FM 5-250, *Explosives and Demolitions*). An AT ditch can be reduced by digging four holes in the side walls (two on each side) near the bottom of the ditch. Holes should be about 5 feet apart and 2 feet deep in each wall directly opposite each other. Satchel charges can be placed in the holes and detonated simultaneously. Further reduction can be accomplished using shovels.

M1A1/M1A2 Bangalore Torpedo. The bangalore torpedo is a manually placed explosive-filled pipe (see figure B-2). It is designed to create a footpath through obstacles such as AP minefields and wire. Bangalores generate one short impulse. Many modern mines require two impulses or a single, long impulse for detonation. Generally, bangalores do not generate enough overpressure to detonate AT mines unless placed beside or on top of the AT mine. It consists of ten sections. Each section is 1.5 meters long and weighs 15 lbs. For speed and simplicity, bangalores should be primed nonelectrically with a single cap in the detonator well.

Improvised Bangalore Torpedo. An improvised bangalore can be made using lengths of pipe or engineer stakes filled with 2 lbs of explosive per foot (see figure B-3). The pipe or engineer stake should be tightly packed with explosives.

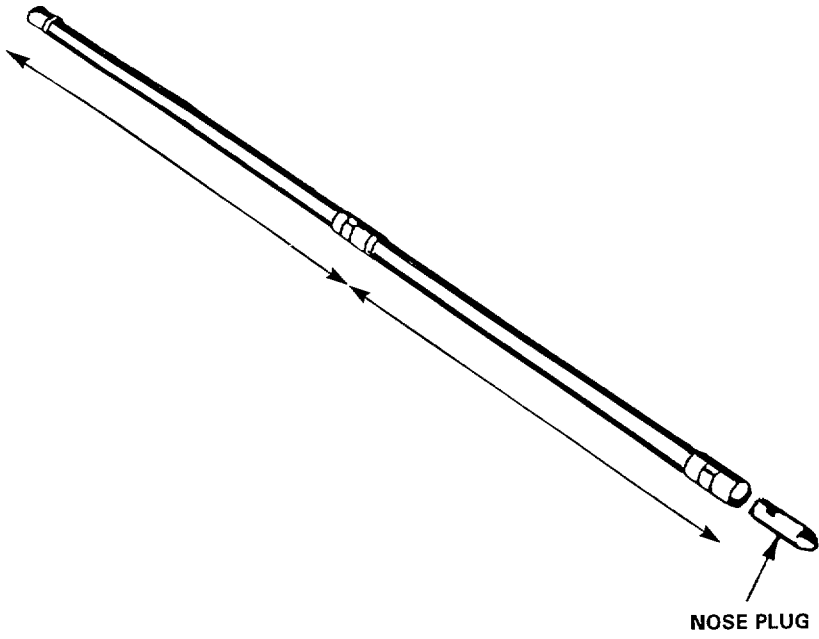

Figure B-2. M1A1/M1A2 Bangalore Torpedo.

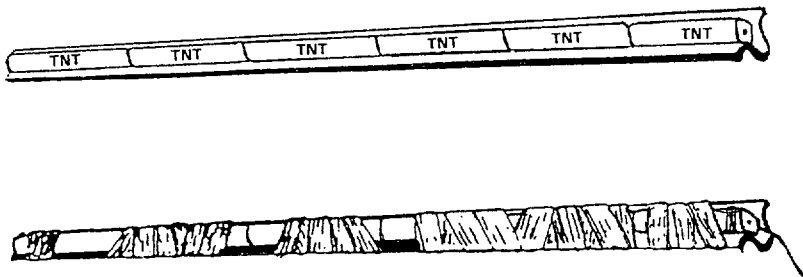

Figure B-3. Improvised Bangalore Torpedo.

B-4

Grapnel—There are three grapnels per minefield marking kit (see figure B-4). Individuals can usually throw the hook no more than 25 meters, which is within the casualty radius of many types of mines. There should be excess rope for standoff distance. Grapnels can detonate mines by activating trip wires and antihandling devices. One technique for using the grapnel is for a thrower to toss the grapnel and seek cover in case the impact detonates a mine. The thrower then moves rearward, reaches the end of the excess rope, takes cover again, and carefully pulls the grapnel toward him. After recovering the grapnel, the thrower moves forward to the original position, and repeats the technique at least two more times. Then he moves to the end of the grappled area and repeats this sequence to the depth of the minefield. Multiple grappers can clear a lane of trip wires more quickly and thoroughly, but their efforts must be simultaneous. After the grapnel is used to clear the trip wires in a lane, engineers can move through the minefield and locate mines. This is a very slow procedure and should only be used after enemy fire has been eliminated.

Grapnels can be fastened to an AAV or some other armored vehicle to reduce wire obstacles. The vehicle is driven to the wire and the crew throws or places the hook into the wire next to a picket. The vehicle then backs away, stretching and breaking the wire. Individuals should take cover in case they detonate a mine. Larger grappling hooks can be fabricated out of angle iron or bar stock.

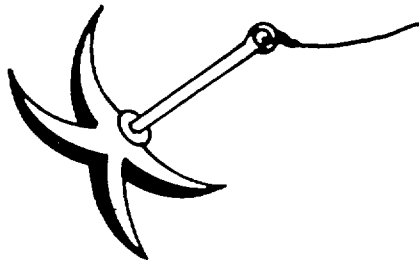

Figure B-4. Grapnel.

Hand-Held Mine Detectors—Mine detectors can be used along with probes to locate obstacles. However, this method is very slow and leaves personnel exposed to enemy fire. Both the Marine Corps and U.S. Army use the AN/PSS 12 mine detector, TAM B0475 (see figure B-5). It consists of a search head, handle, and control box. It is capable of detecting metallic objects and weighs about 8 lbs.

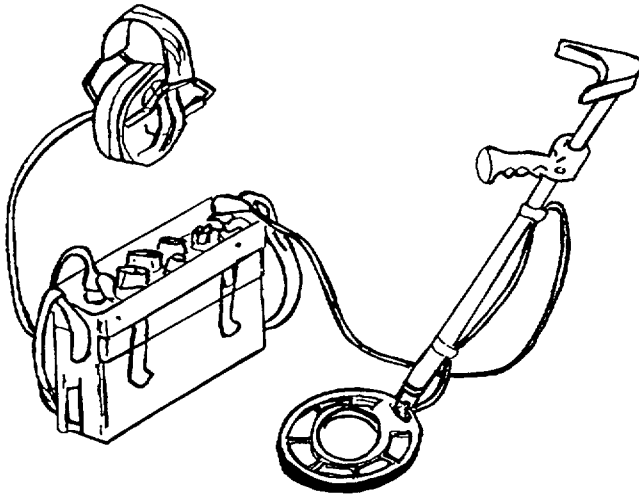

Figure B-5. Hand-Held Mine Detector.

A detector team could consist of: a detector operator, assistant, demo man, and security. The detector operator sweeps a 2-meter wide path, carefully observing the ground for visual indicators as he moves. Immediately behind him, his assistant also visually searches the ground for mine indicators. When the detector operator locates a suspected mine, his assistant places an explosive charge on it. The third member of the team follows with additional breaching charges and a roll of detonating cord. He lays a line main through the minefield and clips the detonating cord from each charge to the line main. The fourth member of the team provides cover.

Detector teams should sweep in echelon and be spaced about 25 meters apart to prevent interference between detectors. Each team must overlap the lane swept by the team to its front. The breach should continue for a distance of at least 150 meters past the first suspected mine location. When each detector team has passed the suspected minefield, the line mains are connected together and the charges are detonated.

Material—Material can be placed over wire after clearing it from mines to make a footpath. Figure B-6 shows a footpath made by using boards attached to a roll of material or chicken wire. Many variations are possible based on available materials.

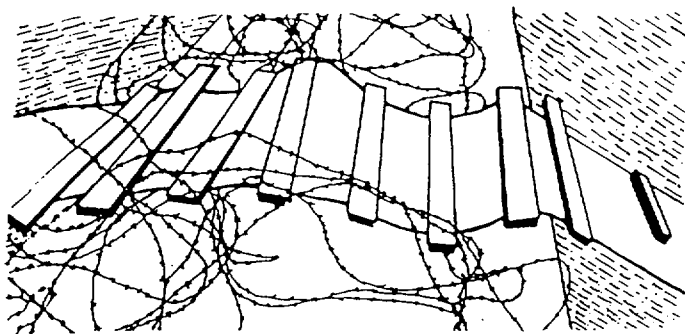

Figure B-6. Material Constructed Footpath.

Probes—Probing for mines is extremely slow; however, it is effective. Only nonmetallic probes should be used and individuals should remove metallic items on their forearms to prevent detonating magnetically influenced mines. Sleeves should be rolled up in order to feel for trip wires. A probing technique is for a lead prober to clear a 1-meter wide path, followed by a second prober one body length behind and staggered, probing to overlap the first path (see figure B-7). Trip wires are traced to their origin. Slack wires should be cut, taut wire and mines marked. Mines and taut trip wires are bypassed by at least 2 meters. Cleared lanes can be marked with engineer tape, chemical lights, or field-expedient markers. If

a chemical light is used, it must be a different color than the ones used for marking mines and taut trip wires. The lights must be shielded from enemy observation. Extensive trip wires and mines may require explosive breaching. Individuals can also use a flashlight to cause reflections and shadows to find trip wires. A wand with a dangling thread can be swept over the ground ahead with the thread being watched for any disturbance by a trip wire

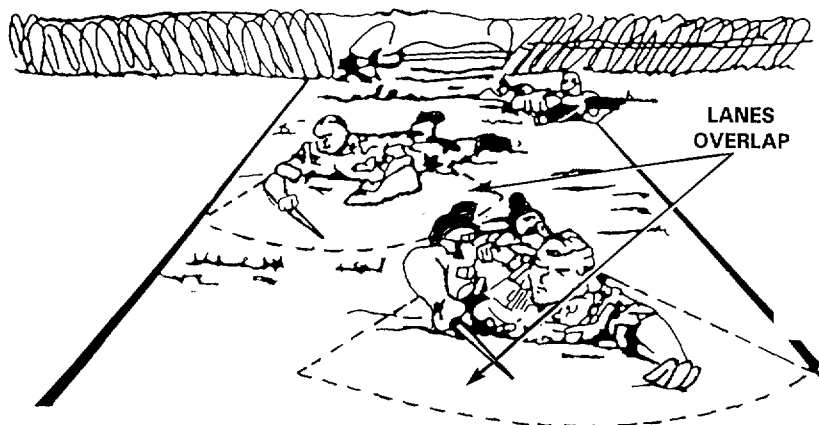

Figure B-7. Overlap Probing Technique.

MECHANIZED EQUIPMENT

Armored Vehicle-Launched Bridge (AVLB)—The AVLB consists of two elements: a scissors bridge (TAM E0149), and the M60 chassis bridge launcher (TAM E0150). The system is an M60 tank chassis modified to transport, launch, and retrieve a military load class (MLC) 60 bridge (see figure B-8). It can support an MLC 60 across a 17.4 meter gap with unprepared abutments or across 18.3 meters with prepared abutments. It can sustain an MLC 68 across gaps of 15.2 meters or less. Future improvements to the bridge will allow for an MLC 70. The AVLB is slow compared to other mechanized assets. During the launch of the bridge, it presents a high profile and can extend above screening smoke to reveal the

B-8

breaching location. It takes about 5 minutes to deploy the AVLB. The bridge can be recovered from the far bank and employed again. The AVLB can be used to overlay an understrength bridge, but it must be cribbed to avoid placing any load on the bridge. It can also be placed on a stream bottom to provide a fording capability over soft or rocky material, but this can cause severe damage to the bridge. Tanks equipped with plows or rollers may exceed the MLC of the bridge and cause extensive damage to the bridge when crossing.

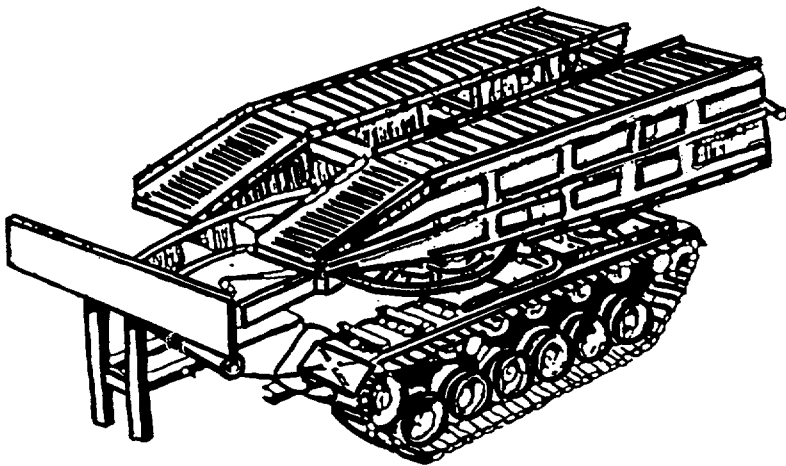

Figure B-8. Armored Vehicle-Launched Bridge.

Blade-Placed Antitank Wall Charges—The blade of an armored combat earthmover or bulldozer can carry a large explosive charge to an AT wall or other vertical-faced obstruction and drop it off against the face of the wall. A wooden frame can be fabricated to carry the charge. It should consist of a rack for the explosives and hook over the dozer blade. It should also have legs to hold the rack up against the wall and shoes to prevent the legs from sinking into the ground. (See figure B-9.)

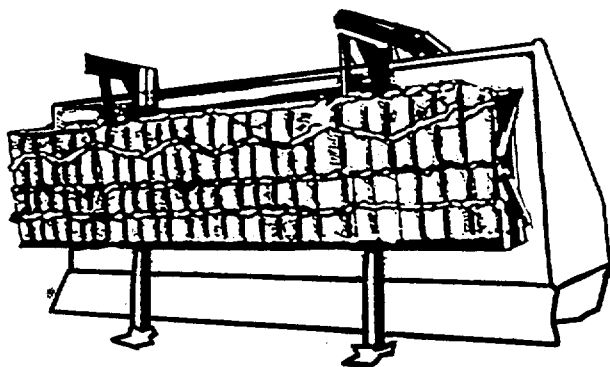

Figure B-9. Blade-Placed Explosive Charge.

Engineer Blades—Blades are ideally suited to break down and reduce earthen gaps such as AT ditches and road craters. Sometimes it is faster to push an earthen ramp over an obstacle rather than remove it. Blades were not designed for breaching minefields. This is extremely dangerous to the equipment and its crew. If a blade must be used, a herringbone skimming technique should be utilized. (See figure B-10.) Multiple overlapping passes should be made, stripping away about 6 inches of soil each time. The operator should skim for no more than 15 meters at a time to prevent excessive spoil from building up in front of the blade. Mines can gather in the spoil in front of the blade and can cause them to detonate. It is also easy for mines to roll under the blade, particularly if the surface is irregular. This technique should only be used as a last resort for removing surface and shallowly buried mines.

Armored Combat Earthmover. The armored combat earthmover is a highly mobile, full-tracked armored earthmover (see figure B-11). It can travel up to 30 mph on land, swim 3 mph in calm water, and is best employed to support earthen obstacle reduction such as overcoming antitank ditches.

B-10

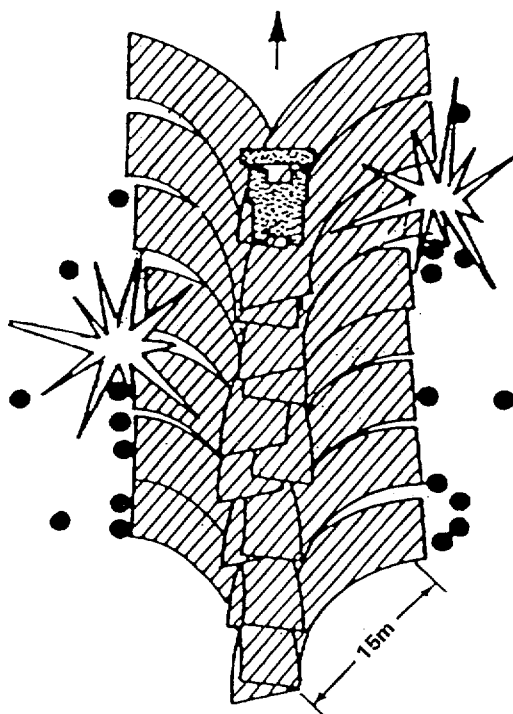

Figure B-10. Herringbone Skimming Technique.

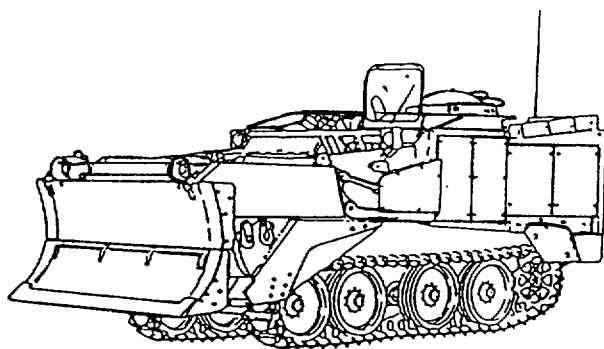

Figure B-11. Armored Combat Earthmover.

Bulldozers. Bulldozers are very effective in countering earthen obstacles. However, there are some big drawbacks in using bulldozers for breaching. Unless the bulldozer is modified, it provides no protection for the operator. Bulldozers are also very slow and require transportation. Figure B-12 shows the D7G medium sized bulldozer.

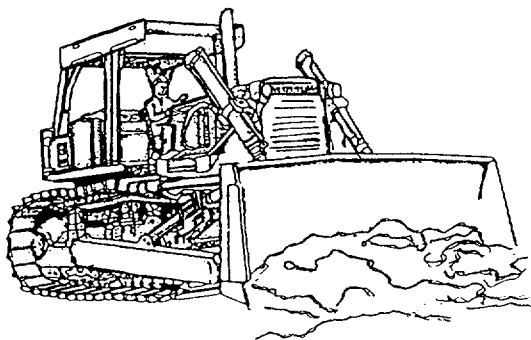

Figure B-12. D7G Medium Sized Bulldozer.

Mine-Clearing Line Charge (MICLIC)—There are currently two types of linear explosive charges, or MICLICs, in the Marine Corps inventory: the M58 and M59. Both types of MICLICs have the same characteristics; the difference is the platform from which they are fired. Each MICLIC contains 1,750 lbs of C-4 and is 105 meters long. The explosive charge is anchored by a rope and gives a 62 meter standoff distance from the charge. It utilizes an electrical detonating system and will create a lane approximately 90 meters deep and 16 meters wide through a minefield containing single impulse pressure activated AT mines and mechanically activated AP mines. Within this zone, the MICLIC detonates 92 to 95 percent of mines that are surface-laid or buried up to 1 inch. Mines buried deeper are less likely to detonate. The MICLIC has a very limited effect on mines that have magnetic, blast-hardened, or other nonpressure-sensitive fuzes. It may uncover or blow such mines sideways out of the lane. The MICLIC is very effective against wire obstacles. It may have reduced effectiveness

B-12

if employed across broken or wooded terrain. After it has been fired, the MICLIC leaves an obvious rut along the center of the cleared path.

Breaching a lane through a minefield of uncertain depth or greater than 90 meters may require more than one MICLIC (see figure B-13). Once the first MICLIC is detonated, a second MICLIC should be detonated further down on the same path formed by the first. The two charges should overlap each other. Additional MICLICs are used as necessary. Detonating more than one line charge in the same lane does not necessarily mean that the lane is twice as clear. Lanes should still be proofed. Failure to proof a lane can significantly increase the chances of encountering an active mine during lane transit. MICLICs must be ready to deploy prior to reaching an obstacle. MICLICs have been mounted and fired from various platforms, including trailers, AAVs, and dump trucks. Practice MICLICs (M 68 and M 69) are available for training.

MK 1 Mine Clearance System. TAM B1315 contains three MICLICs (M 59) and uses an AAV as the host vehicle (see figure B-14). The MK 1 provides the capability of conducting breaches from the water. It can perform multiple breaches of the same obstacle or breach a single lane up to 270 meters. This is the primary explosive breaching system of the Marine Corps.

MK 2 Mine Clearance System. The TAM B1298 contains a trailer-mounted MICLIC (M 58) (see figure B-15). It can be pulled by a host of vehicles including AAVs, armored combat earthmovers, LAVs, and 5 ton trucks. However, the M1A1 tank cannot pull this system unless a heat shield is placed between the tank's exhaust and the trailer. Currently, no such shield has been adopted by the Marine Corps.

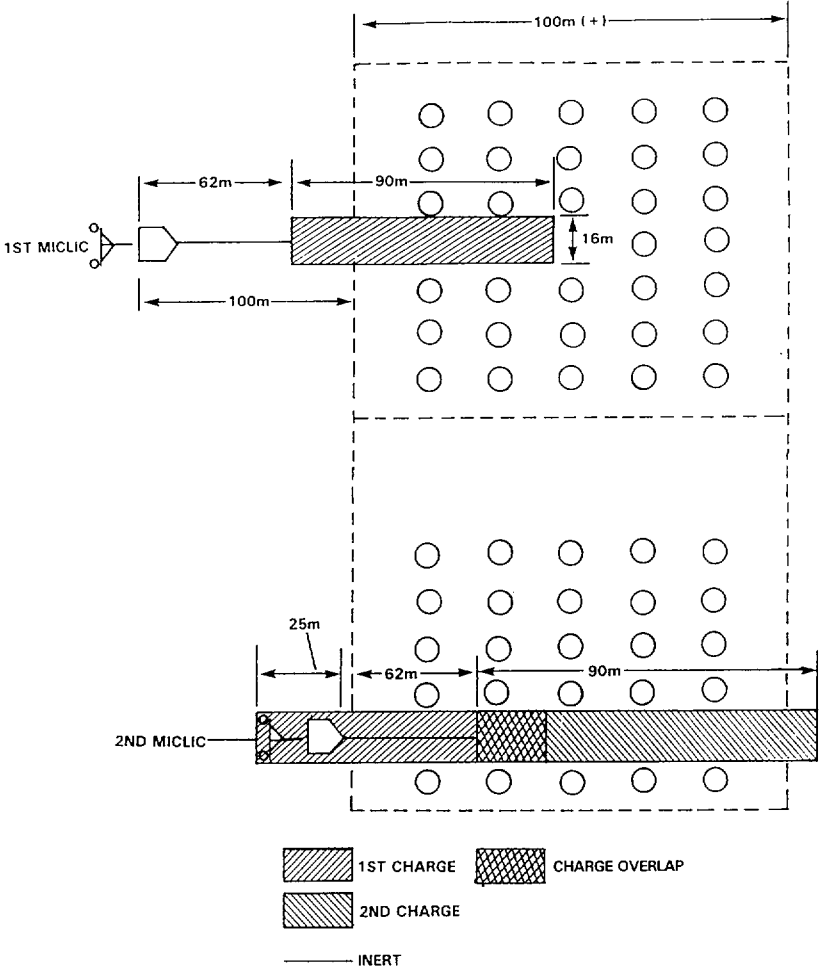

Figure B-13. Use of One or More MICLICs.

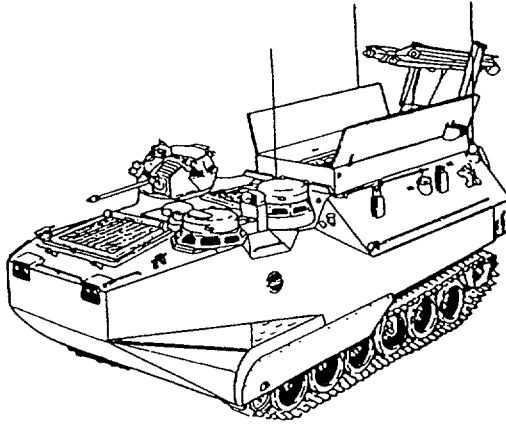

Figure B-14. MK 1 Mine Clearance System.

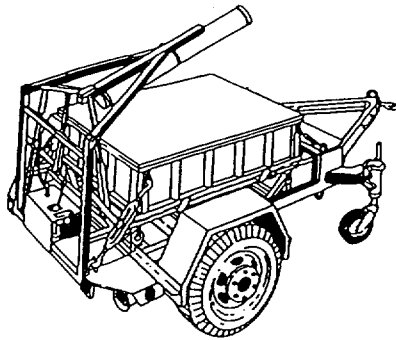

Figure B-15. MK 2 Mine Clearance System.

Track Width Mine Plow (TWMP), TAM E0996—The TAM E0996 lifts and pushes surface-laid or buried mines up to 4 inches deep in front of its path. A float assembly exerts enough pressure to activate most single-pulse mines. This effectively clears a section of the centerline by explosive detonation, but it may disable the plow. A "dogbone" and chain assembly, consisting of a rolling antimagnetic mine actuating device, is used in

conjunction with the plow to defeat tilt-rod and magnetic influence fuzed mines. Mines not lifted and moved by the plow will not be defeated. Mines armed with antihandling/antidisturbance devices or seismic fuzes may detonate when lifted by the plow. Mines lifted by the plow are left in the spoil on each side of the furrowed path and remain a hazard until removed or neutralized. The plow can be mounted to an M1A1 tank (see figure B-16); however, this takes time and it cannot be easily mounted or transferred to another tank under battlefield conditions.

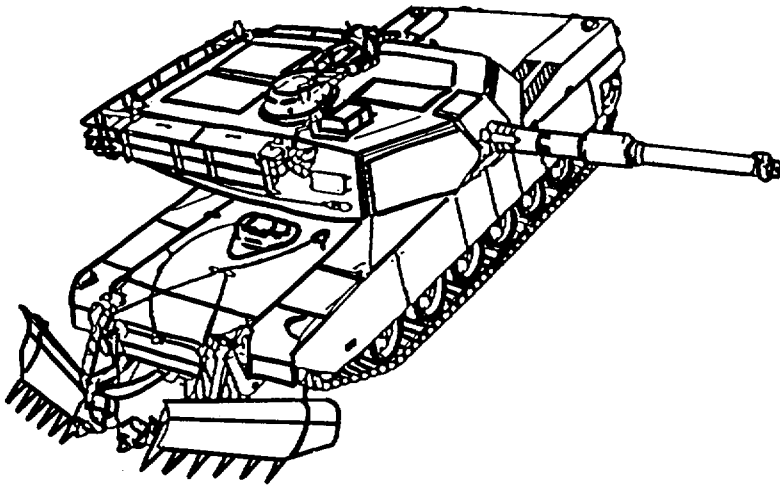

Figure B-16. Track Width Mine Plow Mounted to M1A1 Tank.

The 3-ton plow restricts the tank's maneuverability and speed and prevents the tank from climbing up a vertical step. Tanks mounted with plows cannot negotiate gaps. The plow will restrict the M1A1 to a speed of less than 10 kilometers per hour (depending on soil conditions) when plowing. Although the plow has an emergency disconnect, the tank should not maneuver when it is plowing. A straight course must be maintained to prevent damage to the plow. The main gun should be traversed to the side when plowing because a mine detonating under the plow can throw it into the air.

and damage the gun tube. The area selected for the lane must be relatively flat and free of rocks or other obstructions. The plow creates a 58-inch cleared path in front of each track (see figure B-17). Plowing should begin about 100 meters from the leading edge of a minefield and continue 100 meters beyond the far edge to ensure a complete breach. A second plow should not re-plow the lane, since any deviation from the first plowed path may push mines from the lane centerline into the track width lane created by the first plow.

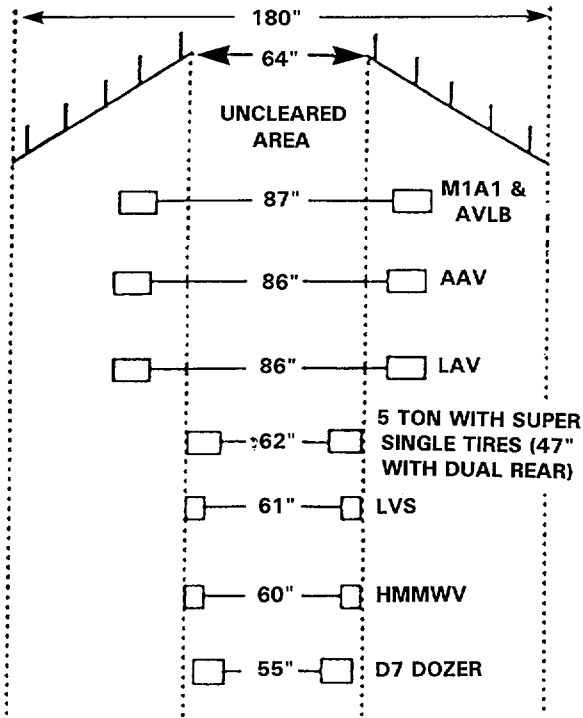

Figure B-17. TWMP Cleared Path.

(reverse blank) B-17

Appendix C

Contingency Equipment for Land Operations

The following equipment is held in various locations for contingency use only. Most of the equipment is held at one or both of the Marine Corps logistics bases (MCLBs) located in Albany, Georgia and Barstow, California. Some equipment is maintained aboard maritime prepositioning force (MPF) shipping. Current information may be obtained by contacting the Program Manager Engineer Systems, Marine Corps Systems Command, Quantico, Virginia at DSN 278-2242, commercial (703) 784-2242, or Program Manager Ground Weapons at DSN 278-2137. The engineer branch (837-3), MCLB, Albany can be contacted at DSN 567-6533/6597/6609.

Fascines—Fascines are large cylindrical bundles of material (usually wood poles, plastic pipes, or metal pipes) loosely bound together and placed singly or in groups in gaps to create a lane (see figure C-1). The material must have enough width and load-bearing capacity to handle the crossing traffic. Fascines can be mounted to any armored vehicle using cable or rope. To employ the fascines, a vehicle pulls up to a gap and releases the fascines into the gap.

Flexible Coil System (FCS)—FCS is a coil of insulated wire with a flexible armor covering. It is used to counter magnetically influenced mines by projecting a magnetic field in front of the host vehicle. Figure C-2 shows an AAV-mounted FCS.

Figure C-1. Fascines.

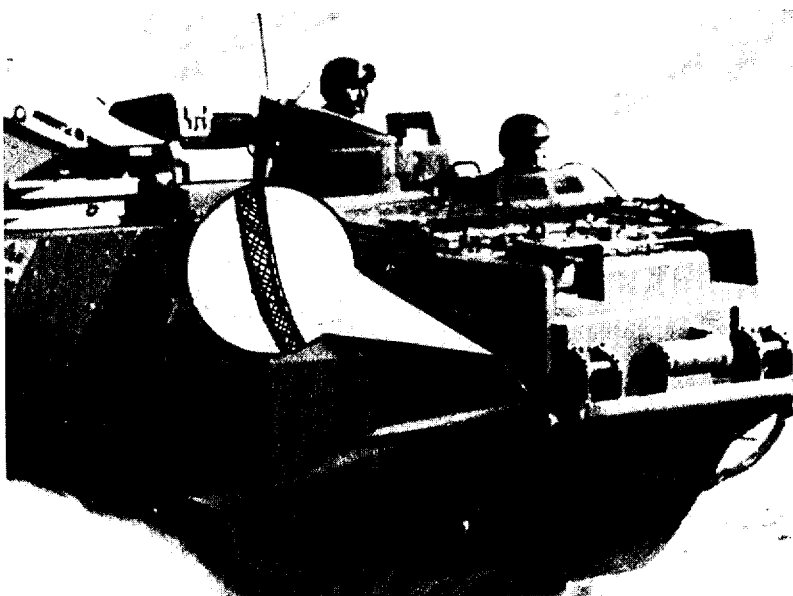

Figure C-2. AAV Mounted Flexible Coil System.

Mine Rollers—Mine rollers are used primarily to detect minefields. A secondary use of mine rollers is to proof lanes created by other means (see figure C-3). However, it is not a good primary system for minefield reduction. The roller is designed to withstand about two mine explosions depending on the amount of explosive material in the mine. A roller can be mounted on M1A1 tanks modified with the permanent attachment of the mine roller mounting kit. Mounting the roller takes time and is difficult under battlefield conditions. The roller weighs more than 10 tons and has a great impact on the tank's maneuverability and speed.

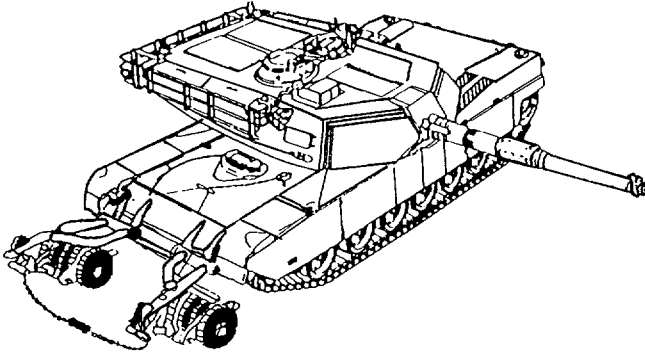

Figure C-3. Mine Roller.

Rollers can be moved with the CSSE on tractor trailers or farther forward if the roller is needed. Planning for its movement and designating an assembly area for mounting the roller is critical. It is most effective when leading columns on route movement but can be used to lead tactical formations. In column movement, vehicles follow the rolled path. However, this causes the column to slow to 5 to 15 kilometers per hour.

A roller tank should travel in a relatively straight path since tight turns may cause the rollers to deviate from the path of the tracks and miss mines. Bumps and berms may cause the rollers to lift from the ground and miss

mines. The main gun should be traversed to the rear or side because a mine blast may throw the roller or parts of the roller into the air and damage the tube. The roller sweeps a 44-inch path in front of each track (see figure C-4). A dogbone and chain assembly between the rollers defeats tilt-rod fuzed mines. Magnetically fuzed mines will not be defeated unless activated or crushed by the roller.

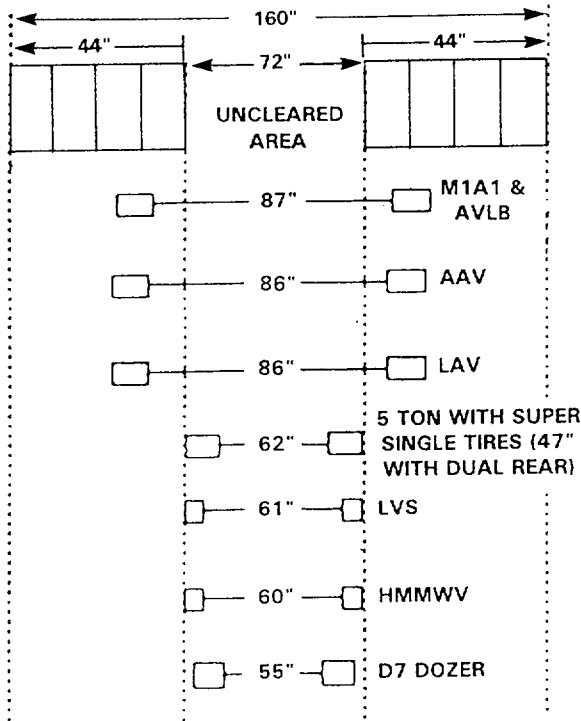

Figure C-4. Mine Roller Path.

Towed Assault Bridge (TAB)—The TAB is emplaced by pushing or towing (see figure C-5). It can support an MLC 70 and is effective in breaching ditches 3-10 meters wide with escarpments up to 3 meters in height. It is equipped with a quick disconnect system and can be emplaced in 30-60 seconds. It can sustain a 50 percent loss of its girders and still retain an MLC 70 rating.

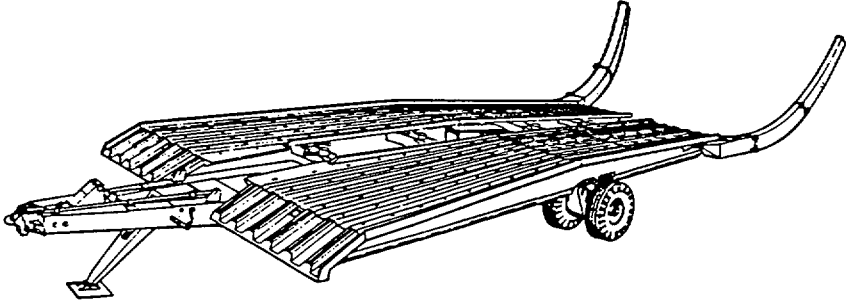

Figure C-5. Towed Assault Bridge.

Tractor Protective Kit (TPK)—The TPK is a ballistic steel-plated kit that can be mounted on the D7G bulldozer (see figure C-6). It is used to protect the bulldozer and operator from small arms fire and shrapnel.

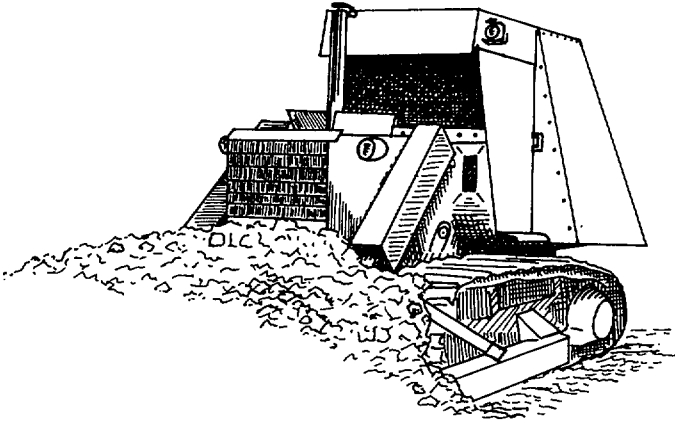

Figure C-6. Tractor Protective Kit.

(reverse blank) C-5

Appendix D

Equipment Under Development for Land Operations

The following equipment is in various stages of development and may or may not become part of the breaching equipment available for Marine Corps use. Current information may be obtained by contacting the Program Manager Engineer Systems, Marine Corps Systems Command, Quantico, Virginia at DSN 278-2242 or commercial (703) 640-2242.

AAV Full-Width Mine Rake—This system has been cancelled. The AAV full-width mine rake was a developmental mechanical proofing device. It was very similar to the U.S. Army full-width mine rake. It was to be mounted on an AAV to be used in conjunction with the MK 1 mine clearance system to provide a means of conducting an amphibious breach across a mined beach (see figure D-1). **There is no available hardware for this cancelled system.**

Airborne Detection—Airborne detection systems are being developed to detect both surface-laid and buried mines. These systems will quickly gather information over large areas of land or water (see figure D-2). Aerial platforms will include helicopters, strategic satellite-based sensor systems, and unmanned aerial vehicles.

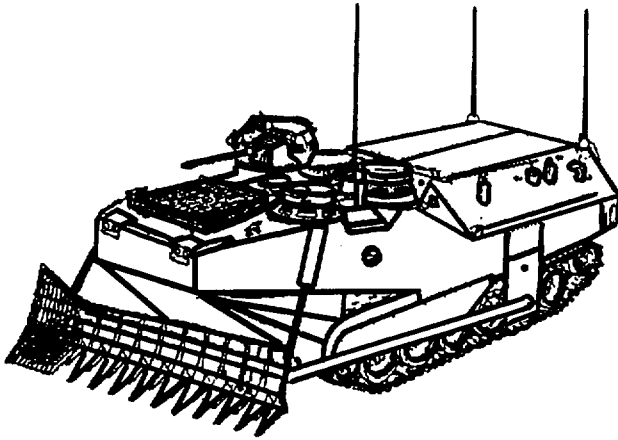

Figure D-1. AAV Full-Width Mine Rake.

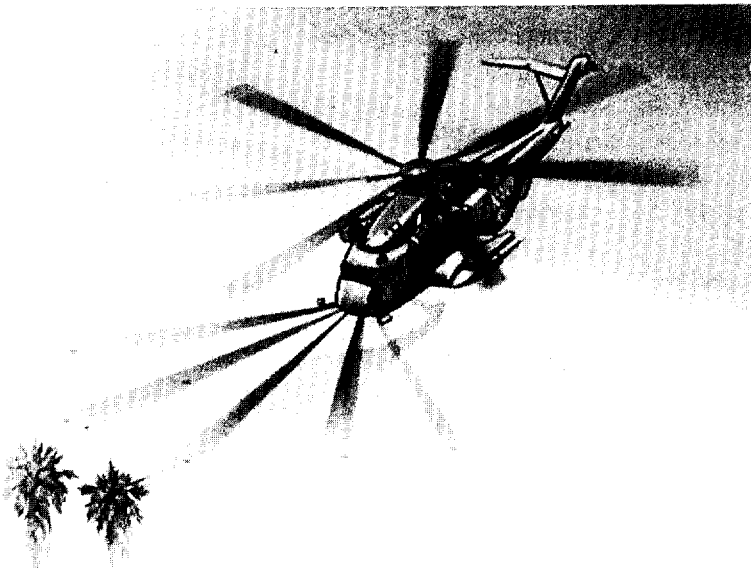

Figure D-2. Airborne Detection.

Antipersonnel Obstacle Breaching System (APOBS)—APOBS is a man-portable line charge designed to create a footpath through obstacles (see figure D-3). It is rocket propelled and has a standoff distance of 25 meters. It is 45 meters long and consists of 108 grenades and detonation cord, packaged in two backpacks. APOBS weighs 120 lbs and can be transported and fired by a two-man team. It can be fired in a delay mode or on command.

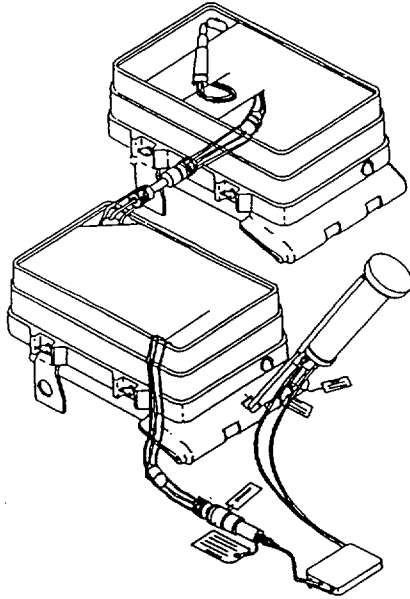

Figure D-3. Antipersonnel Obstacle Breaching System.

Combat Breacher Vehicle (CBV)—The CBV is a developmental system which is designed to breach complex obstacles (see figure D-4). It has a full-width mine clearing blade and a power driven arm with bucket attachment. It is mounted on an M1 chassis and will have mobility and survivability characteristics comparable to the M1A1 tank.

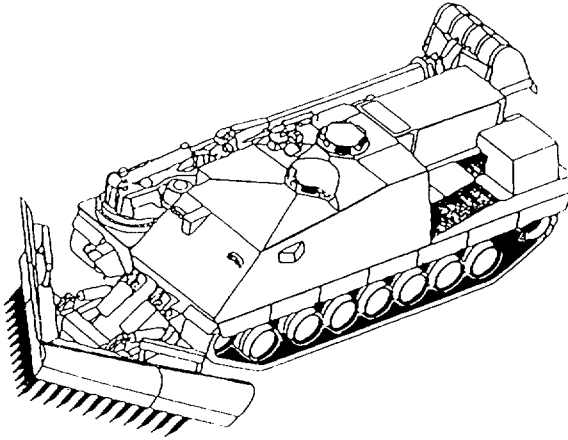

Figure D-4. Combat Breacher Vehicle.

Distributed Explosives—Distributed explosives are being developed which will be more effective than the MICLIC. (See figure D-5.)

Robotic Vehicles—Robotic vehicles utilizing optical, infrared, radar, acoustic, and radio intercept receivers as sensors will be utilized to detect obstacles in the future.

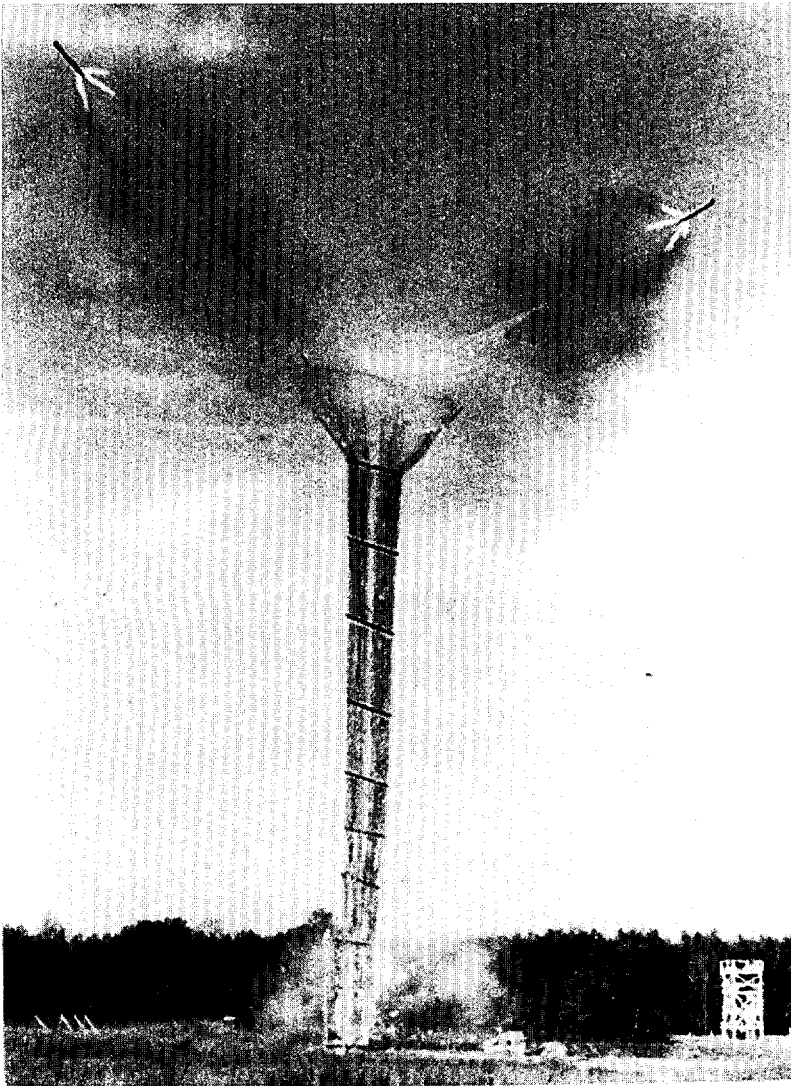

Figure D-5. Distributed Explosives.

(reverse blank) D-5

Appendix E

Breaching Equipment for Amphibious Operations

This appendix focuses on means to overcome the naval mine threat. However, natural obstacles such as tidal range, coral heads, and rocks also limit the ability of an ATF to conduct an amphibious breach, and must always be taken into consideration. Naval mines may be triggered by various types of fuzing: contact, magnetic influence, acoustic influence, pressure influence, or a combination thereof. For a successful amphibious breach, a variety of minehunting, minesweeping, and mine neutralization assets should be employed.

MCM equipment and technology is constantly being upgraded. Commanders should always be aware of the MCM assets that are available. The importance of naval mine warfare and the Navy/Marine Corps ". . . From the Sea" philosophy dictate that obstacles which limit our ability to maneuver at sea must and will be overcome.

PLATFORMS

Airborne Mine Countermeasures (AMCM) Helicopters—There are two types of AMCM helicopters: the MH-53 Sea Dragon (see figure E-1), and the RH-53D Sea Stallion.

Avenger (MCM-1) Mine Countermeasures Ships—These are wooden ships that can detect, classify, and neutralize moored and bottom sea mines, capable of mechanical, magnetic, and acoustic influence minesweeping. See figure E-2.

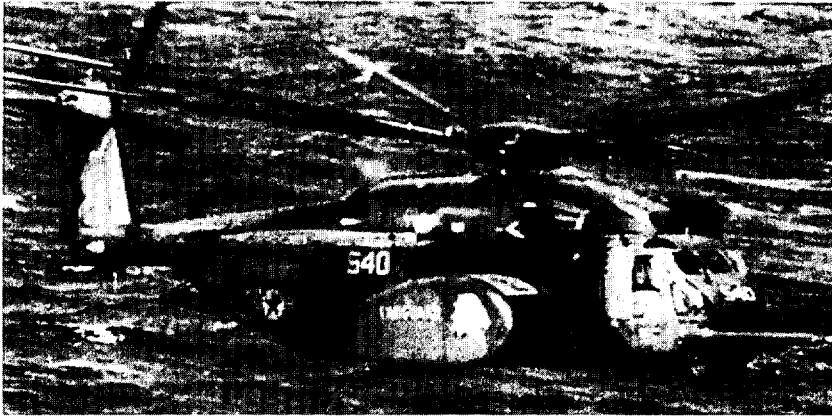

Figure E-1. AMCM Helicopter, MH-53 Sea Dragon.

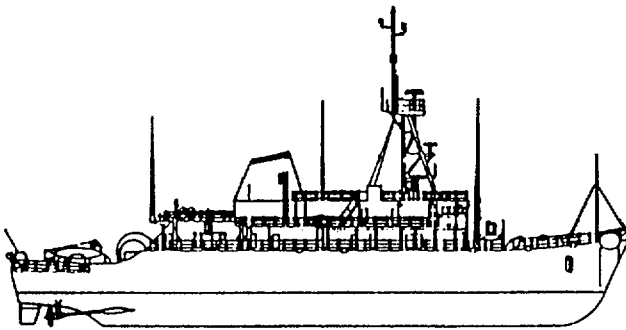

Figure E-2. Avenger (MCM-1) Mine Countermeasures Ship.

Landing Craft Air Cushion (LCAC)/Multipurpose Craft Air Cushion (MCAC)—This platform's high speed and ability to hover over the water makes it less susceptible to destruction from sea mines than water displacement craft (see figure E-3). It can move over many natural obstacles which limit the mobility of displacement craft. Mine neutralization and/or minesweeping equipment can be placed on this platform.

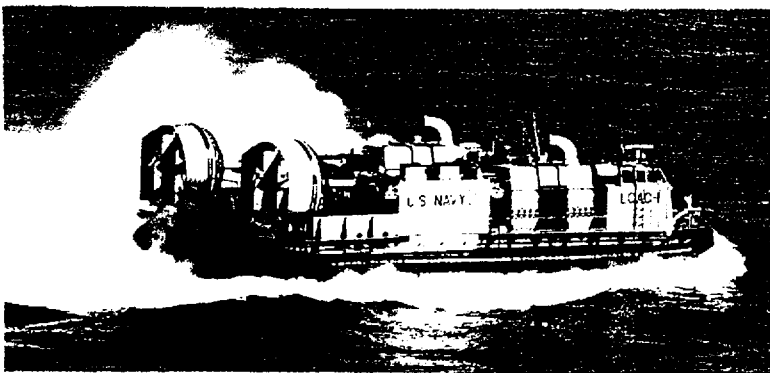

Figure E-3. LCAC/MCAC.

Ocean Minesweepers (MSOs)—Ocean minesweepers (1950's era) which have been decommissioned as MCM and MHC ships joined the fleet. MSOs were fitted for both mechanical and magnetic and acoustic influence sweeping.

Osprey (MHC-51) Coastal Mine Hunter Ships—These are constructed of glass reinforced plastic (GRP) (see figure E-4). They are equipped with mine-hunting sonar and mine neutralizations systems for detecting, classifying, and neutralizing moored and bottom sea mines.

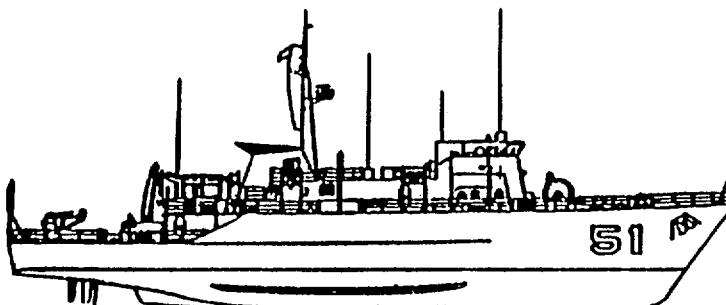

Figure E-4. Osprey (MHC-51) Coastal Mine Hunter Ship.

Remotely Piloted Vehicles (RPVs)—RPVs can be mounted with influence sweep gear to provide an unmanned capability to sweep dangerous areas.

MINE DETECTION SYSTEMS

Airborne Detection Systems—Airborne systems can quickly gather information over large areas of water and land. Aerial platforms include helicopters, strategic satellite-based sensor systems, and unmanned aerial vehicles.

AN/AQS 14. The AN/AQS 14 is a helicopter-towed, multi-beam side looking sonar. It has a display of two continuous moving television-like window pictures.

AN/AQS 20. The AN/AQS 20 is an advanced airborne sonar system that is capable of being towed at higher speeds than the AN/AQS 14. It also provides better sonar coverage and area search rate than the AN/AQS 14.

Magic Lantern 90. Magic Lantern 90 is an airborne laser system used to detect large moored mines. It uses the same type of technology as airborne laser detection systems used for land operations.

Detection by Personnel

Navy EOD Divers. Navy EOD divers can confirm suspected naval mines and perform rendering safe procedures for either mine exploitation or disposal.

SEAL Teams. SEAL teams used for reconnaissance can relay information on coral heads, rocks, and other natural obstacles as well as manmade obstacles such as sea mines.

USMC Force Reconnaissance Company. This company has the capability to conduct hydrographic studies.

Hand-Held Detection Systems—Divers can use hand-held systems to locate mines, however, this method can be very slow. The Navy uses two types of hand-held systems:

AN/PQS 2A. The AN/PQS 2A is a hand-held mine relocation sonar. It uses continuous FM transmissions or passive detection of a sonar beacon to locate mines. The PQS is effective in detecting partially buried mines (more than 50 percent buried). Its performance is degraded when searching for mines on an irregular or cluttered sea bed.

MK 25. The MK 25 is an all metals detector that can be used in depths up to 300 feet. It may detect mines buried as deep as 7-10 feet under the sea bed. It is designed for pinpointing the suspected location of a buried mine.

Surface Ship Detection Systems

AN/SQQ 14. The AN/SQQ 14 is a dual-frequency mine detection and classification sonar for minesweepers. It is intended primarily for use in shallow water against bottom mines. It is lowered from under the hull by a flexible cable.

AN/SQQ 30. The AN/SQQ 30 is a solid-state mine detection and classification sonar. It is also lowered from under the hull by a cable. It can be operated more easily and at greater depths than the AN/SQQ 14.

AN/SQQ 32. The AN/SQQ 32 is a variable-depth mine detection and classification sonar. It is better at discriminating between mines and other objects than the AN/SQQ 14 or AN/SQQ 30. It can identify objects using near picture quality images and can be used from within the hull in shallow water. The AN/SQQ 32 can detect and classify buried mines.

MINESWEEPING SYSTEMS

Minesweeping is the technique of clearing mines using either mechanical, explosive, or influence sweep equipment. Mechanical sweeping removes, disturbs, or otherwise neutralizes the mine; explosive sweeping causes sympathetic detonation in, damages, or displaces the mine; and influence sweeping produces either the acoustic and/or magnetic influence required to detonate the mine (Joint Pub 1-02).

Airborne Minesweeping Systems—The U.S. Navy currently utilizes several types of helo-pulled mine sweepers:

A MK 2. The A MK 2 can also be towed by an aerial platform.

AN/37U-1. The AN/37U-1 is an advanced MK 103. It can be controlled from a helicopter for use in greater depths.

Magnetic Orange Pipe (MOP). A helicopter can tow as many as three MOPs in tandem. This increases the number of ship counts that a magnetically influenced mine detects thereby helping to defeat such mines.

MK 103. The MK 103 is a helicopter-towed mechanical cutter array that is designed to sever the cables which keep moored mines in place.

MK 104. The MK 104 is a helicopter-towed acoustic sweep device that makes noises like a ship to trigger acoustic or seismic mines on the ocean bottom.

MK 105. The MK 105 is a helicopter-towed magnetic influence sled sweep system that puts a magnetic signature in the water (see figure E-5).

MK 106. The MK 106 is a helicopter-towed acoustic/magnetic sweep device. It consists of the MK 105 sled with an attached MK 104.

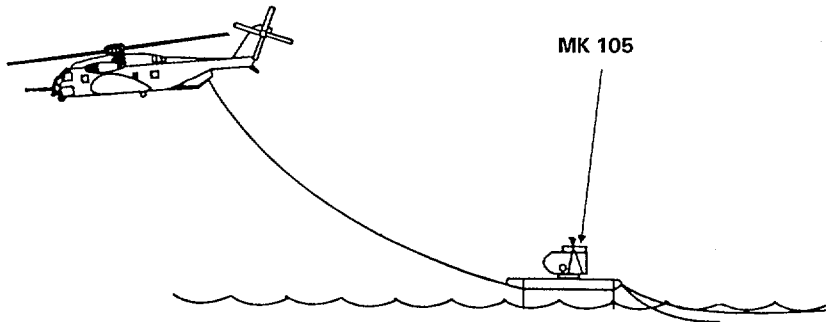

Figure E-5. MK 105 Under Tow.

Surface Ship Minesweeping Systems

A MK 2. The A MK 2 is an acoustic sweep device that consists of parallel pipes or bars that are towed in different variants and at different speeds to produce different frequencies.

A MK 4. The A MK 4 is an acoustic sweep device. It consists of a towed hammer box that can be used by all types of surface minesweepers. It has an electrically driven hammer that produces medium-frequency acoustic energy.

A MK 6. The A MK 6 is a very low-frequency acoustic sweep device that generates acoustic energy by means of a diaphragm driven by pistons from an electric motor.

AN/SLQ 53. The AN/SLQ 53 is a mechanical cutter array that is designed to sever the cables which keep moored mines in place. It is being developed for the MHC-51 Osprey class ship. It will enable ships to mechanically sweep for deep and shallow moored mines.

M MK 5. The M MK 5 is a magnetic sweep device that has a straight tail, two-electrode sweep.

MOP. The MOP is a magnetized pipe filled with styrofoam that can be pulled behind an MCM ship. It is used to defeat magnetically influenced mines.

SLQ 38. The SLQ 38 wire sweep is designed to be used against mines which are moored close to the surface. It is standard on the MSO and MCM-1 class ships. The wire can be rigged to one or both sides of a hull and pulled through the water. It can also be rigged to two different ships to increase the swept area.

MINE NEUTRALIZATION

Direct Fire—Direct fire from ships, landing craft, or AAVs can be effective in neutralizing floating mines.

Mine-Clearing Line Charge (MICLIC)—Twelve MICLICs (see appendix B) can be loaded onto and fired from various platforms, including AAVs and landing craft. Water has a tamping effect on the MICLIC and increases the overpressure which is created. Figure E-6 shows a LCAC pre-loaded with 12 MICLICs. Tests using this configuration have been conducted and are ongoing by Surface Warfare Development Group, Norfolk, VA.

MK 1 Mine Clearance System—The MK 1 clearance system (see appendix B) provides the capability of conducting breaches from the water. The MK 1 mine clearance system can perform multiple breaches of the same obstacle or breach a single lane up to 270 meters in length. This is the primary explosive breaching system of the Marine Corps.

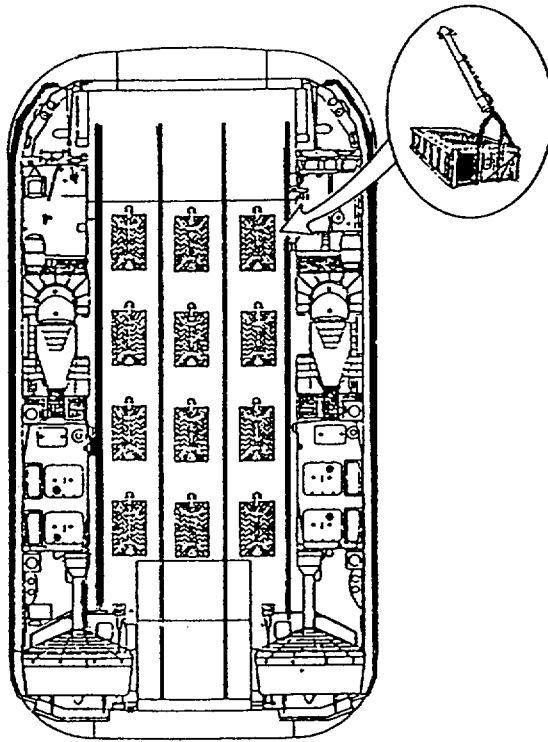

Figure E-6. LCAC Preloaded with 12 MICLICs.

Navy EOD Divers—Navy EOD divers can manually place explosives to destroy or remove antilanding obstacles such, wire, debris, or sea mines. However, this can be very dangerous and time intensive.

SLQ 48 Mine Neutralization System (MNS)—This system is a remotely operated submersible vehicle used by MCM-1 and MHC-51 class ships. The SLQ 48 is commanded from the launching ship by an umbilical cable. It can be tracked by shipboard sonar and has a television for examining the target. The SLQ 48 carries cable cutters and explosive mine destruction charges.

BREACHING EQUIPMENT UNDER DEVELOPMENT

Airborne Mine Neutralization System (AMNSYS)—A torpedo-like device that is launched from a helicopter and then guided to mines and detonated. This developmental system is designed to be effective in both deep and shallow water.

Distributed Explosives—Distributed explosives (see figure D-5) will be more effective than the MICLIC against more types of mines.

Pressure Influence Systems—Will provide a pressure influence sweep.

STATIC BOMB TESTS

The summary of static bomb tests located on pages E-12 through E-19 is derived from an Army Air Forces board study completed on 21 March 1944. It was undertaken to develop a technique for the passage of beach and underwater obstacles. Obstacles used in 1944 are similar to those anti-landing defenses which forces may encounter today. Although this study was conducted over 50 years ago, it still contains useful information that can be applied to help determine the effects of various sized bombs on beach and underwater obstacles.

All tests were fired with electric caps from the tail with the exception of tests no. 24 through 29. In these tests, the bombs were fired from the nose with electric caps.

Test#	Obstacle	Bomb	Position
1	6' X 6' reinforced concrete wall	200 lb demolition	5' below surface at 60° angle with horizontal, simulating high-level bombing with delay fuzing.
2	6' X 6' reinforced concrete wall	1,000 lb demolition	3' below surface and 5' in front of wall horizontal, simulating low-level bombing with delay fuzing.
3	Dragons teeth	500 lb demolition	5' below surface at 60° angle with horizontal, simulating high-level bombing with delay fuzing.
4	Dragons teeth	500 lb demolition	Flat on surface, simulating low-level bombing with delay fuzing.
5	Log piling	500 lb demolition	60° angle with horizontal, with nose just in surface, simulating high-level bombing with instantaneous tail fuzing.
6	Log piling	500 lb demolition	3' below surface at 60° angle with horizontal, simulating high-level bombing with delay fuzing.
7	Log piling	500 lb demolition	Flat on surface, simulating low-level bombing with delay fuzing.
8	Antitank ditch	100 lb demolition	4 in a train on the surface at 60° angle with horizontal, simulating high-level bombing with instantaneous tail fuzing.
9	Antitank ditch	100 lb demolition	5' under the crest of the high side of the ditch and 5' back of the lip, simulating extremely low-level bombing with delay fuzing.

Results
TEST #1: <u>Successful breach for troops.</u> Resulting crater impassable to vehicles. 2 teller mines 30' and 40' from the bomb were not detonated. 11 man squad passed through crater in 15 seconds. Same squad scaled wall in 23 seconds.
TEST #2: Section of wall moved back 2'. Otherwise unaffected. <u>Crater formed impassable to vehicles.</u>
TEST #3: 7 teeth removed completely, 2 teeth damaged. <u>Resulting crater impassable to vehicles.</u> First 3 lines of teeth unharmed.
TEST #4: 3 teeth completely destroyed, 1 pushed into crater of first bomb, 2 badly damaged and several slightly damaged. Results on the whole were better than in test #3. First 3 rows of teeth unaffected.
TEST #5: 3 piles were removed and a crater 16.5' in diameter and 2.5' deep was formed. A teller mine 40' from the bomb was detonated. Wire was removed the entire width of the entanglement.
TEST #6: 8 piles were removed and a crater formed 8' deep and 22' in diameter, <u>impassable to vehicles.</u> A teller mine 30' from the bomb was not detonated. Wire outside of the crater was not removed.
TEST #7: 6 piles were removed and 2 damaged to ineffectiveness. Only a shallow crater was formed. The wire throughout the width of the entanglement was removed. <u>Tanks could have passed through the obstacle.</u>
TEST #8: 35' gap in wire on one side, 20' gap in wire on the other side. 2 teller mines 20' from the bomb detonated, 1 teller mine 25' from the bomb detonated; shallow craters formed on banks of ditch; <u>ditch remained impassable to vehicles.</u> The shallow craters formed would not have hindered the passage of vehicles.
TEST #9: The high side of ditch was blown down and the wire in the ditch was covered by sand. <u>A light and medium tank passed through the gap.</u> After 5 minutes work by 5 men and a half-track, armored car and 2 1/2 ton truck passed through.

Test#	Obstacle	Bomb	Position
10	Antitank ditch	250 lb demolition	5.4' under the crest of the high side of the ditch and 9' back of the lip, simulating extremely low-level bombing with delay fuzing.
11	Underwater rails and barbed wire	500 lb demolition	Standing on nose, 60° angle with horizontal under 1' of water, simulating high-level bombing with instantaneous tail fuzing. Bomb 5' from nearest rail.
12	Underwater rails and barbed wire	500 lb demolition	Flat on the sea floor under 3' of water, simulating low-level bombing with delay fuzing. Bomb 6' from nearest rail.
13	Underwater rails and barbed wire	1,000 lb demolition	Flat on the sea floor in 3' of water, simulating low-level bombing with delay fuzing.
14	Underwater rails and barbed wire	2,000 lb demolition	Flat on the sea floor in 2' of water, simulating low-level bombing with delay fuzing.
15	Underwater rails and barbed wire	100 lb demolition	Flat on the sea floor in 2.5' of water 3 bombs placed .5', 1.0', and 2.0' from individual rails. Simulating low-level bombing with delay fuzing.
16	Tubular steel scaffolding	250 lb demolition	Flat on the sea floor perpendicular to line of obstacle, 4' inside obstacle from sea face, under 1' of water, simulating high-level bombing with instantaneous tail fuze.

Results
TEST #10: The high side of the ditch was blown down and the wire in the ditch was covered by sand. The sand was packed after the explosion. <u>A light and medium tank, half-track, armored car and 2 1/2 ton truck passed through the gap.</u>
TEST #11: Slight crater formed which rapidly filled in. 1 or 2 wires cut, <u>no damage to rails.</u>
TEST #12: A few strands of barbed wire were cut. <u>No rails were removed.</u> A shallow crater was formed 4' deep and 22.5' in diameter, which rapidly filled in.
TEST #13: 3 rails 7', 10', and 13' from the bomb were blown out, rail 10' from the bomb was untouched. Some wire remained in the crater formed. The crater rapidly filled in.
TEST #14: 4 rails 9', 10', 11', and 12' from the bomb were blown out; rail 18' from the bomb was untouched. All the wire in the crater formed was eliminated. The lip of the crater projected about 18" above the surface of the water immediately after the explosion but washed away in about 5 minutes.
TEST #15: Rail 2' from the bomb was bent over parallel to and 1.3' from the sea floor. Rails 1' and 5' from bombs were broken off .3' from the sea floor. No appreciable craters formed.
TEST #16: <u>15' of scaffolding was effectively removed</u> with the exception of 1 tube in the center slanting seaward. It would not have stopped landing craft. The crater formed was negligible.

Test#	Obstacle	Bomb	Position
17	Tubular steel scaffolding	500 lb demolition	Standing on nose, 60° angle with horizontal, 4.5' from seaward face of obstacle under 4' of water, simulating high-level bombing with delay tail fuzing.
18	Tubular steel scaffolding	500 lb demolition	Flat on the sea floor parallel to and 4.5' from seaward face of obstacle under 3.5' of water, simulating low-level bombing with delay fuzing.
19	Tubular steel scaffolding	1000 lb demolition	Flat on the sea floor parallel to and 4.5' from seaward face of obstacle under 3.5' of water, simulating low-level bombing with delay fuzing.
20	Horned scullys	2,000 lb demolition	Standing on nose 60° angle with horizontal under .5' of water, simulating high-level bombing with delay tail fuzing.
21	Horned scullys	1,000 lb demolition	Flat on the sea floor under 4' of water, simulating low-level bombing with delay fuzing.
22	Horned scullys	500 lb demolition	Flat on the sea floor under 4' of water, simulating low-level bombing with delay fuzing.
23	Barbed wire entanglement	20 lb fragmentation bombs	Flat on the ground in a 30' band of double apron wire.
24	Barbed wire entanglement	20 lb fragmentation bombs	A train of 3 on 15' centers standing on their noses at 60° angle with horizontal through a 30' band of double apron wire, simulating high-level bombing with instantaneous nose fuzing.

Results
TEST #17: <u>The end 43' of obstacles were removed;</u> some tubes remained loosely waving in the gap under water but would not have stopped landing craft. The crater formed had no lip above the sea floor.
TEST #18: <u>25' of scaffolding was effectively removed.</u> The crater formed had no lip above the sea floor.
TEST #19: <u>45' of scaffolding was effectively removed.</u> The crater formed had no lip above the sea floor.
TEST #20: 2 adjacent scullys were shattered and blasted out of position 75' apart. The reinforcing held them together, however, and they remained as effective obstacles though out of place. The crater formed had no lip above the sea floor.
TEST #21: 2 adjacent scullys were shattered and blasted out of position 35' apart. One was 2/3 destroyed and the other remained an effective obstacle. The crater formed had no lip above the sea floor.
TEST #22: 2 adjacent scullys were blown 25' apart. They were slightly shattered and 1 lost a rail, but otherwise they were intact. The crater formed had no lip above the sea floor.
TEST #23: 1 or 2 wires were out.
TEST #24: The group of 3 mutually helped each other and cut more wires in their individual area than the single bomb in test #22 did, but they were not nearly as effective as 100 lb demolition bombs. About half the wires were out in the 30' band.

Test#	Obstacle	Bomb	Position
25	Antitank mines	100 lb demolition	A train of 5 on 25' centers standing on their noses at 60° angle with horizontal, through minefield. Simulating high-level bombing with instantaneous nose fuzing.
26	Antitank mines	100 lb demolition	A train of 5 on 15' centers standing on their noses at 60° angle with horizontal, through minefield. Simulating high-level bombing with instantaneous nose fuzing.
27	Antitank mines	100 lb demolition	A train of 3 on 15' centers standing on their noses at 60° angle with horizontal, through minefield. Simulating high-level bombing with instantaneous nose fuzing.
28	Antitank mines	250 lb demolition	A train of 3 on 30' centers standing on their noses at 60° angle with horizontal, through minefield. Simulating high-level bombing with instantaneous nose fuzing.
29	Antitank mines	250 lb demolition	A train of 3 on 15' centers standing on their noses at 60° angle with horizontal, through minefield. Simulating high-level bombing with instantaneous nose fuzing.

Results
TEST #25: Path not adequate.
TEST #26: Due to 2 failures and 1 partial detonation, the test was inconclusive. Mines that detonated near bombs that fired are an indication of good results.
TEST #27: Indicates that a high percentage of clearance could be expected over a path 15' wide.
TEST #28: Indicates that a high percentage of clearance could be expected over a path 15' wide.
TEST #29: Indicates 92 percent clearance over a path 30' wide.

Appendix F

U. S. Army Breaching Equipment

This appendix lists only two of the many pieces of U.S. Army breaching equipment. The Army has a large quantity of mechanized breaching equipment compared to the Marine Corps. For further information call DSN 676-7301/commercial (314) 563-4080 or write—

Commandant
U.S. Army Engineer School
ATTN: ATSE-CD
Fort Leonard Wood, Missouri 65473-6620

Full-Width Mine Rake (FWMR)—The full-width mine rake is an array of vertical plates welded into a V-shape frame (see figure F-1). It is effective in sandy or loose soil and plows to a depth of 12 inches. It can clear a 15 foot wide path against antitank mines; however, antipersonnel mines may still be left in the clear path. Currently, the FWMR is for contingency use only and is not issued to units. After action reports from Operation Desert Storm stress that a full width plow or rake capability is preferred over a track width plow.

M728 Combat Engineer Vehicle (CEV)—The M728 CEV is a full-tracked armored vehicle which consists of a basic M60A1 tank with a hydraulically operated debris blade, a 165mm turret mounted demolition gun, and a retractable boom and winch (see figure F-2). The demolition gun may be elevated or depressed for use at various ranges up to 925 meters and is coaxial mounted with a 7.62mm machine gun. A .50 caliber machine gun is cupola mounted. A mine clearing rake was specially designed and fabricated for the CEV in Desert Storm. The full-width rake allows the CEV to clear minefields in noncohesive, granular soils.

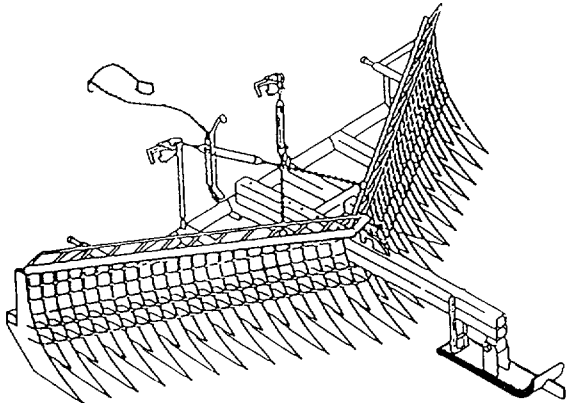

Figure F-1. Full-Width Mine Rake.

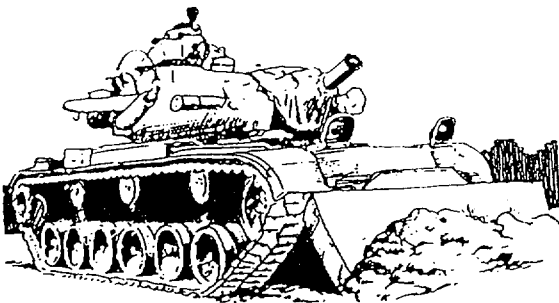

Figure F-2. M728 Combat Engineer Vehicle.

Appendix G

Glossary

Section I. Abbreviations and Acronyms.

AAV	assault amphibious vehicle
ACE	aviation combat element
AMCM	airborne mine countermeasures
AMNSYS	airborne mine neutralization system
AOA	amphibious objective area
AP	antipersonnel
APOBS	antipersonnel obstacle breaching system
AT	antitank
ATF	amphibious task force
AVLB	armored vehicle-launched bridge
C ²	command and control
CATF	commander, amphibious task force
CAX	combined arms exercise
CBV	combat breacher vehicle
CEV	combat engineer vehicle
CLF	commander, landing force
CLZ	craft landing zone
co	company
COA	course of action
CSS	combat service support
CSSE	combat service support element
EI	essential elements of information
enr	engineer
EOD	explosive ordnance disposal
FAE	fuel air explosive
FASCAM	family of scatterable mines
FCS	flexible coil system
FEX	field exercise

FM	frequency modulation; U. S. Army field manual
FMF	Fleet Marine Force
FMFM	Fleet Marine Force manual
FMFRP	Fleet Marine Force reference publication
FSCC	fire support coordination center
FWMR	full-width mine rake
GCE	ground combat element
GPS	global positioning system
GRP	glass reinforced plastic
HC	hexachloroethane
HE	high explosive
HEMMS	hand-held emplaced minefield marking system
HLZ	helicopter landing zone
HMMWV	high mobility, multipurpose wheeled vehicle
IPB	intelligence preparation of the battlespace
ITS	individual training standard
LAV	light armored vehicle
LCAC	landing craft air cushion
LD	line of departure
LF	landing force
LMIS	logistics management information system
LVS	logistics vehicle system
m	meter
MAGTF	Marine air-ground task force
MCAC	multipurpose craft air cushion
MCCRES	Marine Corps Combat Readiness Evaluation System
MCLB	Marine Corps logistics base
MCLLS	Marine Corps Lessons Learned System
MCM	mine countermeasures
METT-T	mission, enemy, terrain and weather, troops and support available-time available
MHC	mine hunter, coastal
MICLIC	mine-clearing line charge
min	minute
MLC	military load class

mm	millimeter
MNS	mine neutralization system
MOP	magnetic orange pipe
MOUT	military operations on urbanized terrain
MPF	maritime prepositioning force
MSO	minesweeper, ocean
NAI	named area of interest
NATO	North Atlantic Treaty Organization
NEF	naval expeditionary force
NSFS	naval surface fire support
OAS	offensive air support
obj	objective
OBSTINTEL	obstacle intelligence
OP	observation post
OPFOR	opposing force
OPORD	operation order
OTH	over-the-horizon
PL	phase line
plat	platoon
RP	red phosphorus
RPV	remotely piloted vehicle
SEAL	sea-air-land
SMAW	shoulder-launched multipurpose assault weapon
SOP	standing operating procedure
SOSRR	suppress, obscure, secure, reduce, and resupply
STANAG	standardization agreement
SW	shallow water
SZ	surf zone
TAB	towed assault bridge
TEWT	tactical exercise without troops
TPK	tractor protective kit
TRP	target reference point
TWMP	track width mine plow
VSW	very shallow water
WP	white phosphorus

Section II. Definitions.

A

amphibious breach—A type of deliberate breach specifically designed to overcome antilanding defenses in order to conduct an amphibious assault.

assault breach—A breaching operation used to penetrate enemy protective obstacles and continue the assault through an objective.

B

breach—The employment of any means available to break through or secure a passage through an enemy defense, obstacle, minefield, or fortification. (FMFRP 0-14)

bypass—Maneuvering around an obstacle, position, or enemy force to maintain the momentum of advance. Previously unreported obstacles are reported to higher headquarters. Bypassed enemy forces are reported to higher headquarters. (FMFRP 0-14)

C

complex obstacle—An obstacle system composed of several obstacle types, such as mines employed with wire, tank ditches, and tetrahedrons. Complex obstacles are often used to reinforce a natural obstacle feature such as a river, dry gap, or surf zone.

conventional mines—Mines that wait for a target to come into contact with them or trigger their fuzes by devices like trip wires, tilt rods, and magnetic influence devices. They may be buried, surface-laid, or mechanically scattered. Some conventional mines can be

pre-programmed with various self-destruct times. Usually, the self-destruct time cannot be altered after the mine is emplaced.

covert breach—A breaching operation used to overcome obstacles without being detected by the enemy.

craft landing zone—That area on or near a beach designated for landing, offloading, and onloading by a surface landing craft such as the landing craft air cushion.

D

deep water—Water more than 200 feet deep.

deliberate breach—A type of breach specifically designed to cross a strong and/or well-defended obstacle in order to continue the mission.

I

in-stride breach—A breaching operation used to quickly overcome unexpected or lightly defended tactical obstacles.

K

killing zone—An area in which a commander plans to force the enemy to concentrate so as to destroy him with conventional weapons or the tactical employment of nuclear weapons. (Joint Pub 1-02)

M

mine—1. In land mine warfare, an explosive or other material, normally encased, designed to destroy or damage ground vehicles, boats, or aircraft, or designed to wound, kill, or otherwise

incapacitate personnel. It may be detonated by the action of its victim, by the passage of time, or by controlled means. **2.** In naval mine warfare, an explosive device laid in the water with the intention of damaging or sinking ships or of deterring shipping from entering an area. The term does not include devices attached to the bottoms of ships or to harbor installations by personnel operating underwater, nor does it include devices which explode immediately on expiration of a predetermined time after laying. (Joint Pub 1-02)

mine clearance—The process of removing all mines from a route or area. (Joint Pub 1-02)

mine countermeasures—All methods for preventing or reducing damage or danger from mines. (Joint Pub 1-02)

minehunting—Employment of sensor and neutralization systems, whether air, surface, or subsurface, to locate and dispose of individual mines. Minehunting is conducted to eliminate mines in a known field when sweeping is not feasible or desirable, or to verify the presence or absence of mines in a given area. (Joint Pub 1-02)

minesweeping—The technique of clearing mines using either mechanical, explosive, or influence sweep equipment. Mechanical sweeping removes, disturbs, or otherwise neutralizes the mine; explosive sweeping causes sympathetic detonations in, damages, or displaces the mine; and influence sweeping produces either the acoustic and/or magnetic influence required to detonate the mine. (Joint Pub 1-02)

O

obscure—To hide or make something not clearly seen or easily distinguishable.

obstacle—Any obstruction designed or employed to disrupt, fix, turn, or block the movement of an opposing force, and to impose additional losses in personnel, time, and equipment on the opposing force. Obstacles can exist naturally or can be manmade, or can be a combination of both. (Joint Pub 1-02). The effectiveness of an obstacle is enhanced considerably when covered by observation and fire. Obstacles can include abatis, antitank ditches, blown bridges, built-up areas, minefields, rivers, road craters, terrain, and wire. (FMFRP 0-14).

obstacle clearing—The total elimination or neutralization of obstacles.

obstacle reduction—The physical creation of a lane through or over obstacles.

obstruction—(NATO) **1.** Any object which rises far enough above the surrounding surface or above a specific height to create a hazard to aircraft in flight. **2.** Any object which rises far enough above the surrounding sea bed to create a hazard to navigation. (Joint Pub 1-02)

P

proofing—Verifying that a breached lane is free of live mines by passing a mine-resistant vehicle through a lane as the lead vehicle.

S

scatterable mine—In land mine warfare, a mine laid without regard to classical pattern and which is designed to be delivered by aircraft, artillery, missile, ground dispenser, or by hand. Once laid, it normally has a limited life. (Joint Pub 1-02)

secure—In an operational context, to gain possession of a position or terrain feature, with or without force, and to make such disposition as will prevent, as far as possible, its destruction or loss by enemy action. (Joint Pub 1-02)

shallow water—Water that is 40-200 feet deep.

smart mine—A mine that has the ability to search for, detect, discriminate among, select, and attack targets from a stand-off distance. Smart mines may be surface-laid or mechanically scattered.

surf zone—An area where the water depth is 0-10 feet deep.

suppression—Temporary or transient degradation by an opposing force of the performance of a weapons system below the level needed to fulfill its mission objectives. (Joint Pub 1-02)

suppressive fire—Fires on or about a weapons system to degrade its performance below the level needed to fulfill its mission objectives, during the conduct of the fire mission. (Joint Pub 1-02)

V

very shallow water—Water that is 10-40 feet deep.

W

wide area mine—A smart mine that uses sensors to acquire a target, and then launches a sub-munition which destroys the target from the top or side. Wide area mines are designed to destroy both vehicles and helicopters.

Appendix H

References and Related Publications

Allied Tactical Publications

ATP 52 Land Force Combat Engineer Doctrine

Standardization Agreement

STANAG 2889 Marking of Hazardous Areas and Routes
Through Them

Joint Publications

Joint Pub 1-02 Department of Defense Dictionary of Military
and Associated Terms

Joint Pub 3-02 Joint Doctrine for Amphibious Operations

Joint Pub 3-15 Joint Doctrine for Barriers, Obstacles, and Mine
Warfare

Naval Warfare Publications

NWP 22-2/

FMFM 1-7

Supporting Arms in Amphibious Operations

NWP 22-3/

FMFM 1-8

Ship-to-Shore Movement

U. S. Navy Tactical Memorandum

TACMEMO

PZ6022-1-94/OH 1-17 Amphibious Operations in a Mine Environment
(under development)

Fleet Marine Force Manuals and Reference Publications

FMFM 1	Warfighting
FMFM 1-3	Tactics
FMFM 3	Command and Control
FMFM 3-1	Command and Staff Action
FMFM 6	Ground Combat Operations
FMFM 6-8	Supporting Arms Observer, Spotter, and Controller
FMFM 6-18	Techniques and Procedures for Fire Support Coordination
FMFM 7-15	Military Operations in Urban Terrain (Coordinating Draft)
FMFM 13	MAGTF Engineer Operations
FMFM 13-1	Engineer Support to the GCE (under development)
FMFM 13-8	MAGTF Explosive Ordnance Disposal
FMFRP 0-14	Marine Corps Supplement to the DOD Dictionary of Military and Associated Terms
FMFRP 12-2	Infantry in Battle
FMFRP 12-50	Engineers
FMFRP 12-51	Engineer Operations

U. S. Marine Corps Technical Manual

TM 11275-15/3C Principal Technical Characteristics of U.S.
Marine Corps Engineer Equipment

U. S. Army Field Manuals

FM 5-34/ FMFRP 13-5	Engineer Field Data
FM 5-71-3	Brigade Engineer Combat Operations
FM 5-100	Engineer Combat Operations
FM 5-101	Mobility
FM 5-102	Countermobility
FM 5-250	Explosives and Demolitions
FM 20-32	Mine/Countermining Operations
FM 21-16/ FMFM 13-8-1	Unexploded Ordnance (UXO) Procedures
FM 71-1	The Tank and Mechanized Infantry Company Team
FM 71-2	The Tank and Mechanized Infantry Battalion Task Force
FM 71-3	Armored and Mechanized Brigade Operations
FM 90-13/ FMFM 7-26	River Crossing Operations
FM 90-13-1	Combined Arms Breaching Operations

Other Publications

Alfred M. Beck, Abe Bortz, Charles W. Lynch, Lida Mayo, and Ralph F. Weld, *The Corps of Engineers: The War Against Germany* (Washington, D.C.: United States Army Center of Military History, 1985).

Combat Engineer Systems Handbook, 1 April 1995 (U. S. Army Engineer School, Fort Leonard Wood, MO).

Major James F. Gebhardt, Leavenworth Paper Number 17, *The Petsamo-Kirkenes Operations: Soviet Breakthrough and Pursuit in the Arctic, October 1944* (Fort Leavenworth, KS: Combat Studies Institute, U.S. Army Command and General Staff College, 1990).

Bruce I. Gudmundsson, *Stormtroop Tactics: Innovation in the German Army, 1914-1918* (New York: Prager Publishers, 1989).

Arnold Lott, *Most Dangerous Sea: A History of Mine Warfare and an Account of U.S. Navy Mine Warfare Operations in World War II and Korea* (Annapolis, MD: U.S. Naval Institute, 1959).

Fred Majdalany, *The Battle of El Alamein: Fortress in the Sand* (New York: J. B. Lippincott Company, 1965).

Tamara Moser Melia, *Damn the Torpedoes: A Short History of U.S. Naval Mine Countermeasures, 1777-1991* (Washington D.C.: Department of the Navy, Naval Historic Center, 1991).

Ivan Parotkin (ed), translated from the Russian by G.P. Ivanov-Mumjiev, *The Battle of Kursk* (Moscow: Progress Publishers, 1974).

Erwin Rommel, *Attacks* (Vienna, VA: Athena Press, 1979).

Anthony Heckstall-Smith, *Tobruk* (New York: W. W. Norton & Company, Inc., 1959).

U. S. Navy Mine Warfare Plan, Second Edition, February 1994 (Director, Expeditionary Warfare, Office of the Chief of Naval Operations, Washington, D.C., 20350).

U. S. Marine Corps, *The Log*, November 1993.

Index

A

AAV full-width mine rake, cancelled system	D-1, <i>D-2</i>
airborne detection, developmental	D-1, <i>D-2</i>
airborne mine countermeasure helicopters	E-1, <i>E-2</i>
amphibious breach	1-4, 4-1 through 4-12, 4-7
advance force	4-8
amphibious assault sequence	4-8
assault	4-10
embarkation	4-9
movement	4-10
planning and task organization	4-8
rehearsal	4-9
amphibious operations, types of	4-2
assault	4-2
demonstration	4-2
raid	4-2
withdrawal	4-2
continuing the attack	4-10
definition	4-1
fundamentals	4-4
getting to the beach	4-2
lanes	4-5
lane marking	4-10, 7-10
mine countermeasures	4-3
active MCM	4-3
enabling MCM	4-3

passive MCM	4-3
pro-active MCM	4-3
minehunting	4-3
minesweeping	4-3
naval mines	4-3
obscure	4-5
reduce	4-5, 4-9
resupply	4-6
secure	4-5
supporting operations	4-6
suppress	4-4
use	4-1
water depths	4-3
antipersonnel obstacle breaching system	D-3, D-3
Anzio	7-13
armored combat earthmover	B-10, B-11
armored vehicle-launched bridge	1-6, B-8, B-9
assault breach	1-4, 5-1 through 5-6
consolidation	5-4
definition	5-1
engineer contributions	5-4
fundamentals	5-2
lanes	5-3
nature of the assault	5-1
obscure	5-2
planning and task organization	5-3
reduce	5-3
resupply	5-3
secure	5-3
suppress	5-2
use	5-1
assault force	1-8, 1-9
assault ladders	B-2, B-2
Avenger class mine countermeasures ships	E-1, E-2

B

ballistic projectiles	B-1
bangalore torpedo	B-3, <i>B-4</i>
blade-placed antitank wall charges	B-9, <i>B-10</i>
blades, engineer	B-10
bolt cutters	B-3
bombing	B-2, E-11 through E-19
breach force	1-7, <i>I-9</i>
breach planning	1-11
breaching	1-2
actions	1-2
fundamentals	1-5
operations, types of	1-3
organization	1-6
plan	A-1
bulldozers	B-12, <i>B-12</i>
bypass	1-2

C

combat breacher vehicle, developmental	D-3, <i>D-4</i>
combat engineer vehicle, U.S. Army	F-1, <i>F-2</i>
command and control	1-12
commander's intent	1-11
complex obstacle	1-1
covert breach	1-4, 6-1 through 6-6
definition	6-1
fundamentals	6-1
lanes	6-3
obscure	6-2
planning and task organization	6-4
preparing	6-5
reduce	6-3
resupply	6-4

secure 6-2
 suppress 6-2
 use 6-1

D

deliberate breach 1-4, 3-1 through 3-11
 continuing the attack 3-8
 definition 3-1
 economy of force 3-5
 executing 3-8
 execution matrix **3-9**
 fundamentals 3-1
 isolate by fire 3-3
 lanes 3-4
 mass 3-5
 obscure 3-2
 physical occupation 3-3
 planning and task organization 3-4
 preparing 3-6
 reconnaissance 3-8
 reduce 3-3
 rehearsals 3-6
 resupply 3-4
 secure 3-2
 smoke targets 3-2
 suppress 3-1
 synchronize 3-5
 terrain 3-2
 use 3-1
 detector, mine B-6, **B-6**, E-5
 direct fire E-8
 distributed explosives, developmental D-4, **D-5**, E-10

E

Eban-Emael	6-6
El Alamein, the battle of	3-10
enemy intentions	1-8
EOD divers	4-6, E-4, E-9
essential elements of information	1-10
execution matrix	3-9
explosives	B-3

F

fascines	C-1, C-2
flexible coil system	C-1, C-2
force reconnaissance	E-5
full-width mine rake, AAV mounted, cancelled	D-1, D-2
full-width mine rake, U.S. Army	F-1, F-2

G

grapnel	B-5, B-5
---------------	----------

H

hand-held mine detectors	B-6, B-6, E-5
herringbone skimming technique	B-10, B-11

I

improvised bangalore torpedo	B-3, B-4
intelligence	1-8
intelligence preparation of the battlespace	1-8, 1-10
in-stride breach	1-3, 2-1 through 2-16
battalion in-stride breach scenario	2-9 through 2-16

definition 2-1
 executing 2-7
 fundamentals 2-2
 lanes 2-4
 mobility reserve 2-6
 obscure 2-2
 OBSTINTEL 2-6
 planning and task organization 2-5
 preparing 2-7
 reduce 2-4
 resupply 2-4
 secure 2-4
 smoke targets 2-3
 suppress 2-2
 task-organized force **2-6**
 terrain 2-3
 use 2-1

K

Kasserine Pass 8-7
 killing zone 1-2

L

landing craft air cushion **E-2, E-3**
 lane marking 1-7, 7-1 through 7-13
 amphibious operations 7-10
 breached lane marked **2-16**
 levels of lane marking 7-5
 full lane marking 7-8, 7-9, 7-10, 7-12
 initial lane marking 7-5, 7-6
 intermediate lane marking 7-7, 7-8, 7-10, 7-11
 marking device 7-1
 center lane marker 7-2, 7-2

NATO standard markers	7-1, 7-2
night marking	7-2, 7-3
marking pattern	7-3
center lane markers	7-2, 7-4, 7-9
entrance funnel marker	7-4, 7-7
entrance markers	7-4, 7-8
exit funnel markers	7-4, 7-8
exit markers	7-4, 7-6
far recognition marker	7-3, 7-8
far side final approach marker	7-5, 7-8
final approach marker	7-4, 7-7
handrail markers	7-3, 7-4, 7-6
marking systems	7-1
night marking	7-3, 7-10, 7-13
STANAG 2889	7-9
traffic control guides	7-5
lane requirements	1-7, 2-4, 3-4, 4-5, 6-3

M

markers, NATO	7-1, 7-2
marking device	7-1 through 7-3
marking for amphibious operations	7-10
marking pattern	7-3 through 7-5
mass	1-14
material	B-7
material constructed footpath	B-7
mine-clearing line charge	1-6, 2-14, B-12, B-14, E-8
mine detection systems, water	
airborne systems	E-4
AN/AQS 14	E-4
AN/AQS 20	E-4
Magic Lantern 90	E-4
detection by personnel	E-4
EOD divers	4-6, E-4, E-9

SEAL teams	4-4, 4-6, E-4
USMC Force Reconnaissance Company	E-5
hand-held	E-5
AN/PQS 2A	E-5
MK 25	E-5
surface ship systems	E-5
AN/SQQ 14	E-5
AN/SQQ 30	E-5
AN/SQQ 32	E-5
mine detectors	1-6, B-6, B-6 , E-5
minefield marking kit	7-1
mine neutralization, water	E-8
airborne mine neutralization system, developmental	E-10
direct fire	E-8
distributed explosives, developmental	E-10
EOD divers	4-6, E-4, E-9
MCAC mounted line charge	E-8, E-9
Mine-clearing line charge	E-8
MK 1 Mine Clearance System	E-8
pressure influence, developmental	E-10
SLQ 48 mine neutralization system	E-9
minesweeping systems, water	E-6
airborne minesweeping systems	E-6
A MK 2	E-6
AN/37U-1	E-6
Magnetic Orange Pipe	E-6
MK 103	E-6
MK 104	E-6
MK 105	E-6, E-7
MK 106	E-7
surface ship systems	E-7
A MK 2	E-7
A MK 4	E-7
A MK 6	E-7
AN/SLQ 53	E-7

M MK 5	E-7
Magnetic Orange Pipe	E-7
SLQ 38	E-8
MK 1 Mine Clearance System	B-13, B-15 , E-8
MK 2 Mine Clearance System	1-6, B-13, B-15
mobility reserve	2-6
multipurpose craft air cushion	E-1, E-2

N

named area of interest	1-10
NATO standard marker	7-1, 7-2

O

obscure, defined	1-5
obscuring smoke	2-3
obstacle clearing	1-3
obstacle, defined	1-1
obstacle reduction	1-2
OBSTINTEL	1-10
Ocean Minesweepers	E-3
Operation Anvil	4-11
Osprey class coastal mine hunter ships	E-3, E-3

P

plan, breaching	A-1
planning sequence	1-12
probes	B-7
overlap probing technique	B-8
proofing	1-3
protective obstacle	1-2

R

reduce, defined	1-6
reduction assets	1-14
rehearsal	1-14, 8-2 through 8-5
remotely piloted vehicles	E-4
reorganization	1-3
resupply, defined	1-6
reverse planning	1-13
reverse planning sequence	1-12, 3-7
robotic vehicles, developmental	D-4
rollers, mine	1-6, C-3, C-3
cleared path	C-4

S

SEAL teams	4-4, 4-6, E-4
secure, defined	1-5
smoke	1-5, 2-3
SOSRR, defined	1-5
STANAG 2889	7-9
support force	1-6, I-9
suppress, defined	1-5
surprise	1-13
synchronization	1-11

T

tactical obstacle	1-2
Tobruk, Libya	1-15
towed assault bridge	C-5, C-5
track width mine plow	2-15, B-15, B-16
cleared path	B-17
tractor protective kit	C-5, C-5
traffic control guides	7-5

training 8-1 through 8-7

- breaching operations task list 8-2
- combined-arms 8-1
- evaluating unit proficiency 8-1
- exercises 8-5 through 8-7
 - CAX 8-6
 - FEX 8-6
 - map exercises 8-5
 - TEWT 8-6
- necessity 8-1
- rehearsals 8-2
 - back brief 8-3
 - full-scale 8-4
 - principles 8-4
 - sand table 8-3
 - walk through 8-4