

SCOUT PLATOON

TABLE OF CONTENTS

Preface	iii
Chapter 1 INTRODUCTION.....	1-1
Chapter 2 BATTLE COMMAND.....	2-1
Chapter 3 RECONNAISSANCE	3-1
Chapter 4 SECURITY OPERATIONS	4-1
Chapter 5 OTHER TACTICAL OPERATIONS.....	5-1
Chapter 6 COMBAT SUPPORT	6-1
Chapter 7 COMBAT SERVICE SUPPORT	7-1
Chapter 8 BASIC SCOUT SKILLS.....	8-1
Chapter 9 MISCELLANEOUS FIELD DATA.....	9-1
Appendix A COMBAT ORDERS.....	A-1
Appendix B NUCLEAR, BIOLOGICAL, AND CHEMICAL OPERATIONS.....	B-1
Appendix C STABILITY AND SUPPORT OPERATIONS.....	C-1
Appendix D MILITARY OPERATIONS ON URBANIZED TERRAIN.....	D-1
Appendix E ENVIRONMENTAL PROTECTION	E-1
Appendix F RISK MANAGEMENT	F-1

DISTRIBUTION RESTRICTION: Approved for public release; distribution is unlimited.

*This publication supersedes FM 17-98, 9 September 1994.

Appendix G FRATRICIDE PREVENTION G-1

GlossaryGlossary-1

References References-1

Authorization Page

Preface

On the ever-changing landscape of the modern battlefield, the scout platoon remains one of the tactical commander's most valued assets. This is especially true in the traditional role of the cavalry: as the commander's "eyes and ears" on the forward edge of the battle. Today's scout platoon complements its strengths in mobility, speed, and stealth with the latest technology to provide an accurate, timely picture of developments in the area of operations.

This field manual describes how the scout platoon conducts its primary missions, reconnaissance and security. The manual focuses on the principles of platoon operations and on the tactics, techniques, and procedures (TTP) the platoon uses to acquire information and provide security and protection for other units on the battlefield. It also covers a variety of supporting tasks and operations the platoon must perform or coordinate, either as part of its reconnaissance and security missions or as assigned by the commander.

FM 17-98 is for leaders of scout platoons employing either M3-series cavalry fighting vehicles (CFV) or high-mobility multipurpose wheeled vehicles (HMMWV). This covers scout platoons of the armor battalion, the mechanized infantry battalion, the heavy division, the heavy cavalry regiment, and the light cavalry regiment. The principles and TTP are also adaptable for scout platoons of the light division reconnaissance squadron.

Users and readers of FM 17-98 are invited to submit recommendations that will improve its effectiveness. Prepare comments using [DA Form 2028](#), if possible. A memorandum presenting recommendations in a format similar to the form is acceptable as well. Send comments to Commander, USAARMC, ATTN: ATZK-TDD-P, Fort Knox, Kentucky 40121-5000.

Unless otherwise stated, masculine nouns and pronouns do not refer exclusively to men.

CHAPTER 1

Introduction

The scout platoon is organized, equipped, and trained to conduct reconnaissance and, to a limited extent, security for its parent unit. In simplest terms, the platoon serves as the commander's eyes and ears on the battlefield. It employs proper techniques of movement (both mounted and dismounted) and stealth to gather information, its primary function. Scouts provide current battlefield data to help the commander plan and conduct tactical operations.

The scout platoon also conducts limited security missions, but it is not organized and equipped to fight for extended periods or to act as tank killers. Although it can employ a variety of antitank (AT) weapons (AT-4s, M47 Dragons, or Javelins), the platoon normally uses these assets for defensive purposes (self-protection and breaking contact), not for offensive reasons.

CONTENTS

[Section 1](#)

[General](#)

[Section 2](#)

[Tactical Organization](#)

[Section 3](#)

[Responsibilities](#)

[Section 4](#)

[Missions, Capabilities, and Limitations](#)

SECTION 1 — GENERAL

TYPES OF SCOUT PLATOONS

There are several types of scout platoons in the force, including light and heavy division cavalry platoons, air cavalry platoons, and those in separate cavalry troops. (**NOTE:** The areoscout platoon is discussed in detail in [Chapter 6](#) of this manual.) The two most prominent types, however, are the CFV scout platoon and the HMMWV scout platoon. Both types consist of one officer and 29 enlisted soldiers. The platoons are organized by tables of organization and equipment (TOE) into a headquarters element and two or four scout sections (see [Figures 1-1](#) and [1-2](#)). When executing missions, the scout platoon is organized according to the factors of mission, enemy, terrain (and weather), troops, time available, and civilian considerations (METT-TC) into an appropriate tactical organization consisting of a variable number of scout sections or squads.



<p>Vehicle # 1 - Platoon leader</p> 	<p>Vehicle # 4 - Platoon sergeant</p> 
<p>LT (Platoon leader) SGT 19D20 (Gunner) SPC 19D10 (Driver) SPC 19D10 (Scout/Loader)) PFC 19D10 (Scout)</p>	<p>SFC 19D40 (Platoon sergeant) SGT 19D20 (Gunner) SPC 19D10 (Driver) SPC 19D10 (Scout/Loader) PFC 19D10 (Scout)</p>
<p>Vehicles 2 and 5 - Section leaders</p> 	<p>Vehicles 3 and 6 - Squad leaders</p> 
<p>SSG 19D30 (Section leader) SGT 19D20 (Gunner) SPC 19D10 (Driver) SPC 19D10 (Scout/Loader) SPC 19D10 (Scout)</p>	<p>SSG 19D30 (Squad leader) SGT 19D20 (Gunner) SPC 19D10 (Driver) SPC 19D10 (Scout/Loader) PFC 19D10 (Scout)</p>

Figure 1-1. CFV scout platoon.











Vehicle #1 - M2 		Vehicle #4 - MK-19 	
Headquarters element		Headquarters element	
Lt (Platoon leader) SPC (Scout/Gunner) PFC (Driver)		SFC (PSG) SPC (Scout/Gunner) PFC (Driver)	
ALPHA section Vehicle #2 - M2 	BRAVO section Vehicle #5 - M2 	CHARLIE section Vehicle #7 - M2 	DELTA section Vehicle #9 - M2 
SSG (Sec leader) SGT (Sct/Gunner) SPC (Driver)	SSG (Sec leader) SGT (Sct/Gunner) SPC (Driver)	SSG (Sec leader) SPC (Sct/Gunner) PFC (Driver)	SSG (Sec leader) SPC (Sct/Gunner) PFC (Driver)
Vehicle #3 MK-19 	Vehicle #6 MK-19 	Vehicle #8 MK-19 	Vehicle #10 MK-19 
SGT (Sqd leader) SPC (Sct/Gunner) PFC (Driver)	SGT (Sqd leader) SPC (Sct/Gunner) PFC (Driver)	SGT (Sqd leader) SPC (Sct/Gunner) PFC (Driver)	SGT (Sqd leader) SPC (Sct/Gunner) PFC (Driver)

Figure 1-2. HMMWV scout platoon.

VEHICLES

The CFV platoon, equipped with six M3 CFVs, is found in the cavalry squadrons of an armored or mechanized division or in an armored cavalry regiment; it is also found in certain mechanized battalions, specifically in the 3rd Infantry Division. The HMMWV platoon comprises 10 M1025/1026 HMMWVs. It is found in light cavalry regiments, in air cavalry and reconnaissance squadrons, and in mechanized infantry and armor battalions.

PLATOON HEADQUARTERS

The platoon headquarters element provides command and control for the scout platoon. It consists of the platoon leader, the platoon sergeant (PSG), and their respective vehicle crews. The CFV scout platoon rarely uses a headquarters element during tactical operations. The HMMWV scout platoon is organized by TOE with a headquarters element; based on the factors of METT-TC, the headquarters may be split into two subelements (platoon leader and PSG), each moving with a scout section for security.

SCOUT SECTIONS AND SQUADS

The scout section is normally employed as the platoon's basic tactical maneuver organization. Each section is made up of a section leader, squad leaders, and their crews manning two or three CFVs or two to four HMMWVs. The platoon may also be task organized for maneuver purposes into elements known as scout squads; the squad is normally a single vehicle and its crew. (**NOTE:** Refer to [Section 2](#) of this chapter for a discussion of tactical organization.)

SECTION 2 — TACTICAL ORGANIZATION

The scout platoon leader task organizes his platoon to accomplish the mission based on the factors of METT-TC. Unlike most other combat arms platoons, which maneuver together in formation, the scout platoon normally maneuvers as individual scout sections or squads under the direction and control of the platoon leader. A scout section or squad may consist of from one to three vehicles plus any combat elements under its operational control (OPCON). Determining which organization best meets his mission requirements is one of the key decisions the platoon leader must make during his troop-leading procedures.

CFV SCOUT PLATOON

Regardless of the mission it is executing or the formation or movement technique it is using, the CFV scout platoon normally operates in one of three organizations: as three sections with two vehicles in each section, as two sections with three vehicles in each section, or as a six-vehicle platoon. The CFV platoon, with only six reconnaissance platforms, rarely has the luxury of operating a separate headquarters element.

Three-section organization

Three sections are the basic organization for the CFV scout platoon (see [Figure 1-3](#)). This organization allows the platoon to achieve a good compromise between the requirement of employing a maximum number of elements during the reconnaissance or security mission and the need for security. It is the ideal organization for the conduct of a route reconnaissance mission. In a screen mission, this organization allows employment of three long-duration observation posts (OP), which are occupied for 12 or more hours; it also facilitates the simultaneous conduct of dismounted patrols.

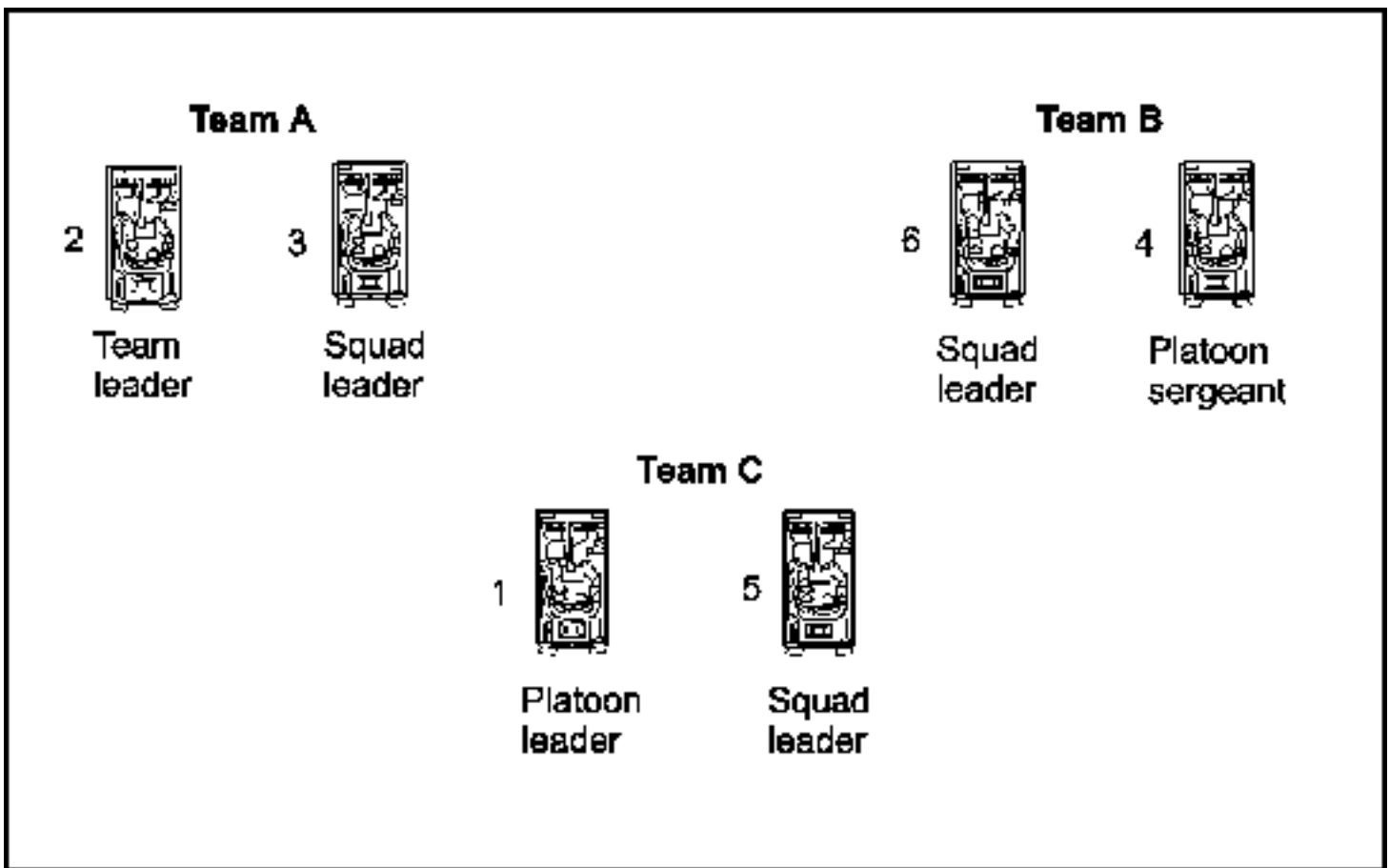

Figure 1-3. CFV scout platoon three-section organization.

In this organization, the platoon leader and PSG are members of scout sections (C and B, respectively). As members of these sections, they have to perform both scout duties and the command and control requirements of their duty positions. To minimize their workload, these leaders must make maximum use of their gunners, and they should position themselves as the overwatch element within their sections.

Two-section organization

The two-section organization is used when increased security is required, when the area of operations can be covered efficiently with only two elements, or when operational strength (less than six vehicles operational) makes the three-section organization impossible. The two sections are formed by splitting the C element of a three-section organization; refer to the illustration in [Figure 1-4](#).

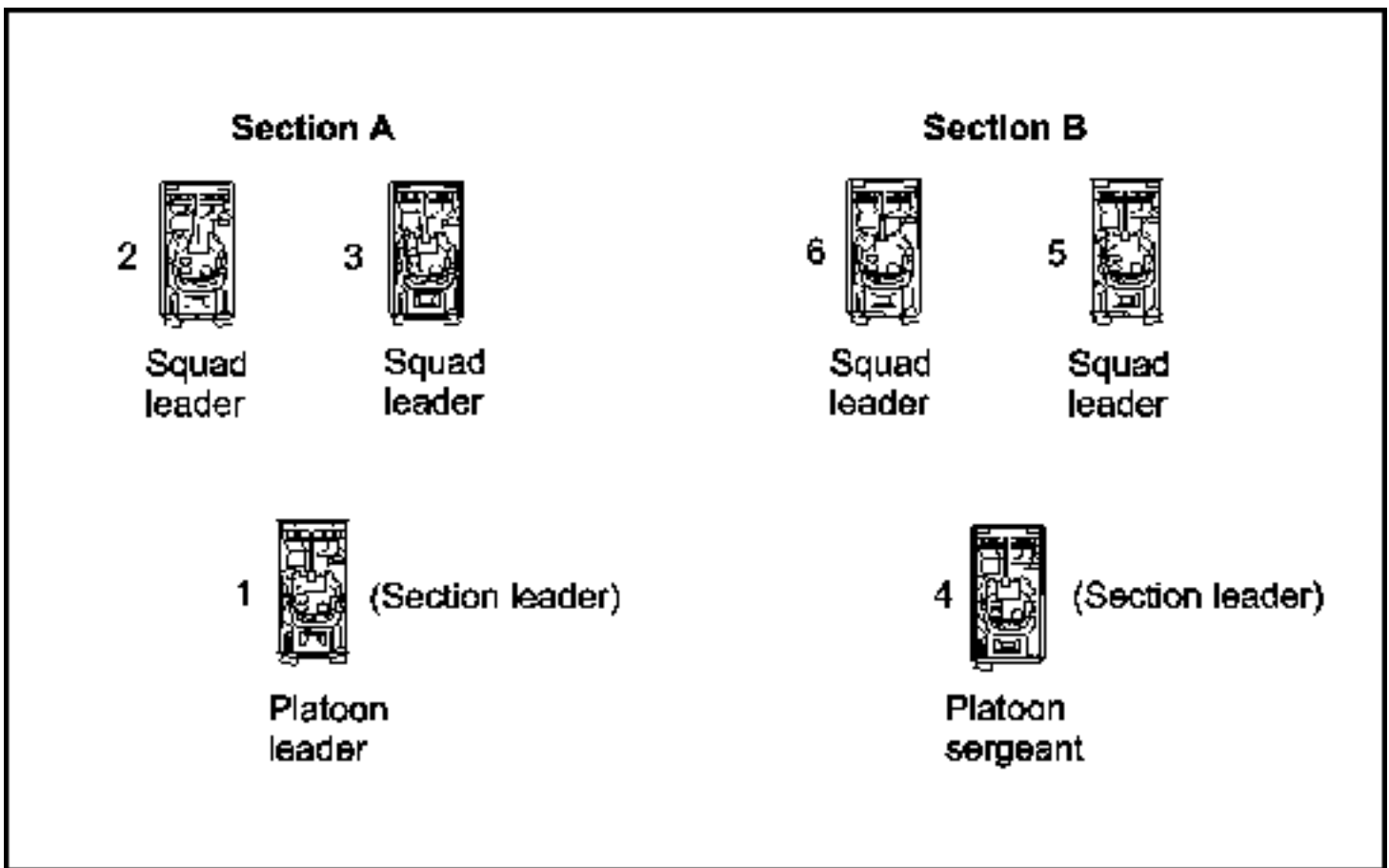

Figure 1-4. CFV scout platoon two-section organization.

Six-vehicle organization

The six-vehicle organization is the most difficult to control (refer to [Figure 1-5](#) for an illustration). The platoon leader employs this organization when he must have six separate information sources at the same time.

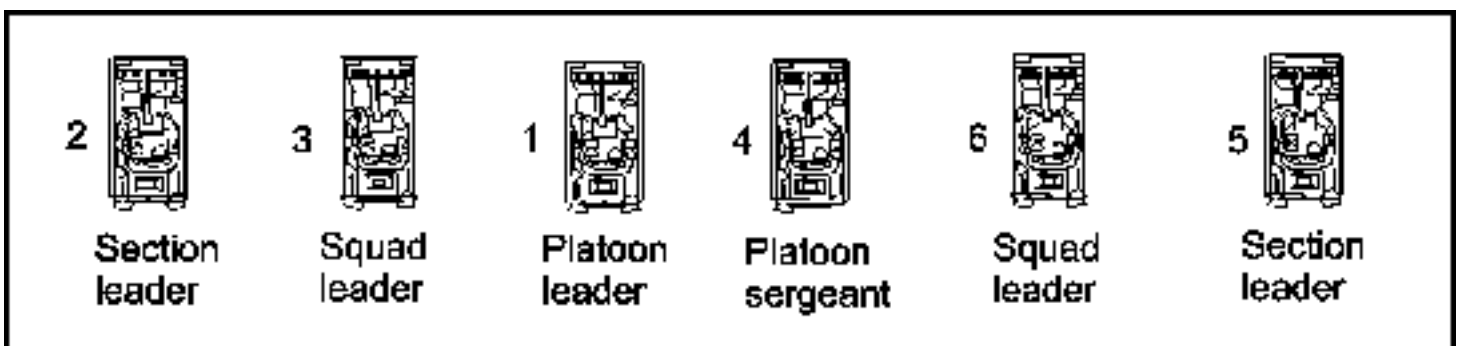

Figure 1-5. CFV scout platoon six-vehicle organization.

HMMWV SCOUT PLATOON

With 10 vehicles, the HMMWV scout platoon has a wide variety of organizational options. The platoon leader selects an organization based on his METT-TC analysis. The basic maneuver element of this platoon, as in the cavalry scout platoon, is the scout section. The platoon also includes a headquarters element, which consists of both the platoon leader and the PSG or the platoon leader only.

The HMMWV platoon's headquarters element focuses on command and control of the platoon. It travels with a scout squad for security, but it positions itself as needed based on the analysis of METT-TC factors and the command and control requirements of the mission. When both the platoon leader and PSG are in the headquarters element, the element will normally be split among the scout sections to disperse command and control capability throughout the platoon.

The following paragraphs discuss basic organizational options for the HMMWV platoon. The platoon leader may develop other combinations to meet unique METT-TC requirements and to accommodate attachments. The platoon leader, no matter how he organizes his platoon, has only a limited number of soldiers to conduct dismounted operations. Because of such manpower constraints, the platoon is unable to both conduct dismounted patrols and occupy OPs at the same time.

Two-section organization

This is an effective organization when only two maneuver corridors have to be observed or when two distinct reconnaissance missions are required. This organization maximizes security at the section level and gives the sections sufficient maneuver and command and control capability to conduct limited separate missions. This organization allows the platoon to put out two long-duration OPs; it is the best organization for dismounted operations. (See [Figure 1-6](#).)

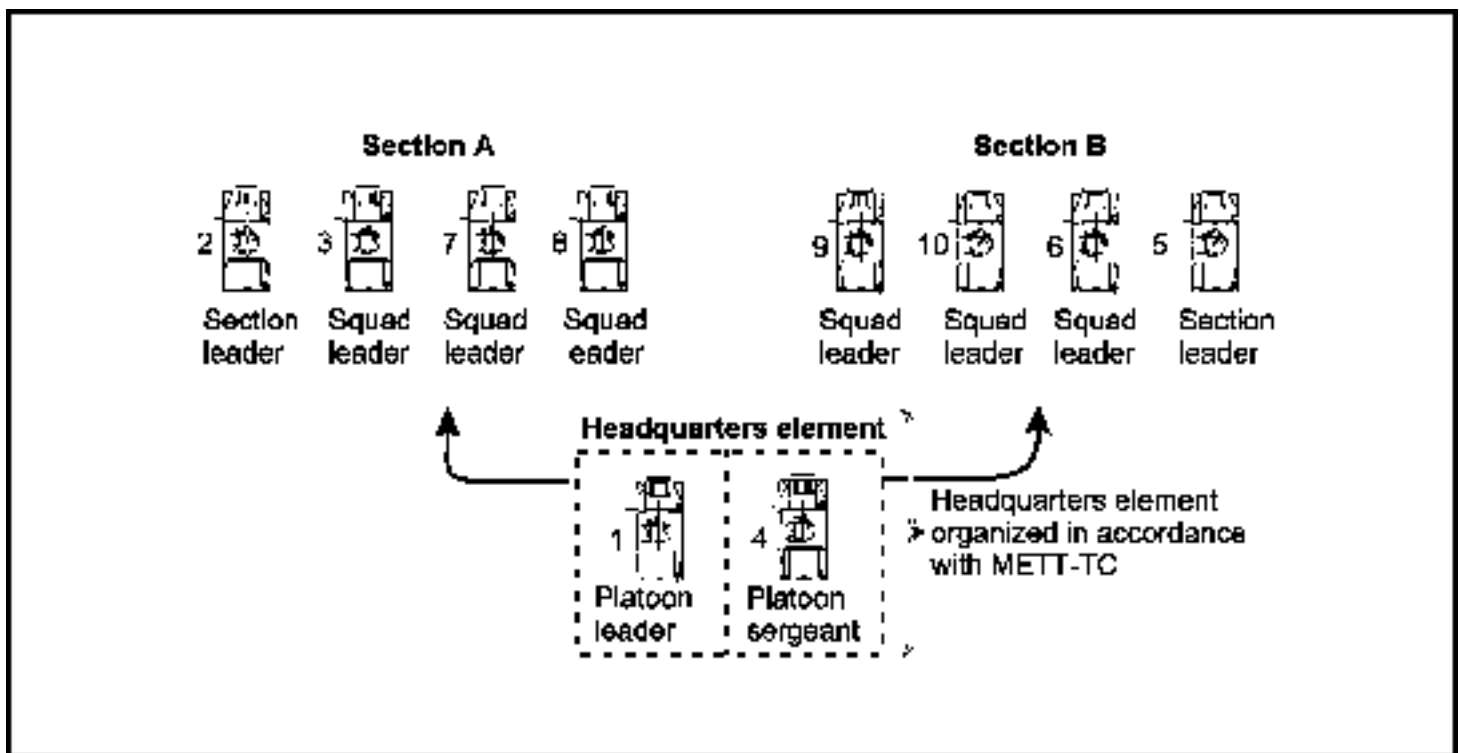

Figure 1-6. HMMWV scout platoon two-section organization.

Three-section organization

This organization is ideal for reconnaissance along a single route. It allows employment of three long-duration OPs; the ability to concurrently conduct dismounted patrols is somewhat limited. (See [Figure 1-7](#).)

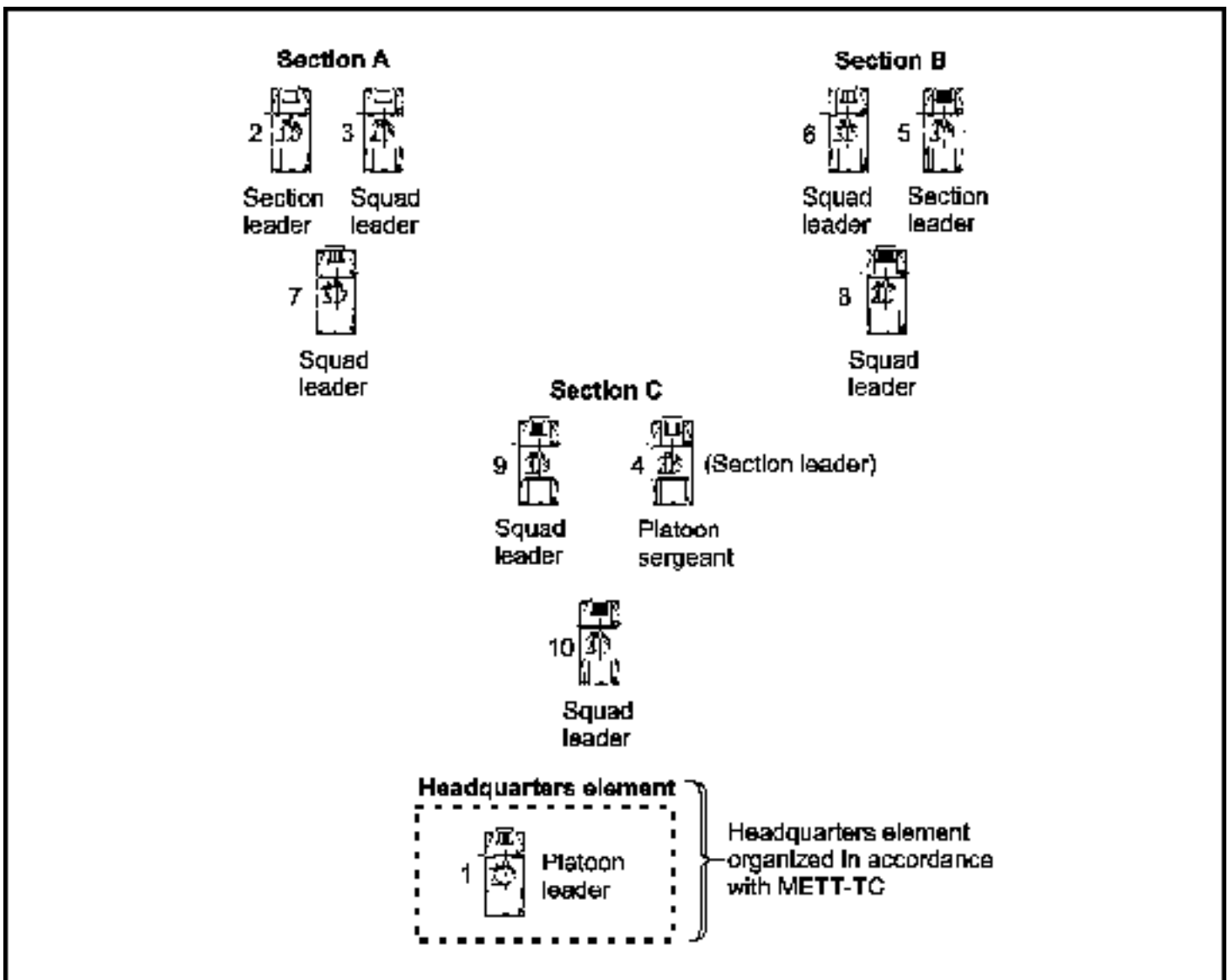

Figure 1-7. HMMWV scout platoon three-section organization.

Four-section organization

This organization is used in reconnoitering large areas or multiple maneuver corridors. Four short-duration OPs can be established, allowing OPs to be structured in depth. In this organization, sections have dismounted capability to conduct local security only. (See [Figure 1-8.](#))

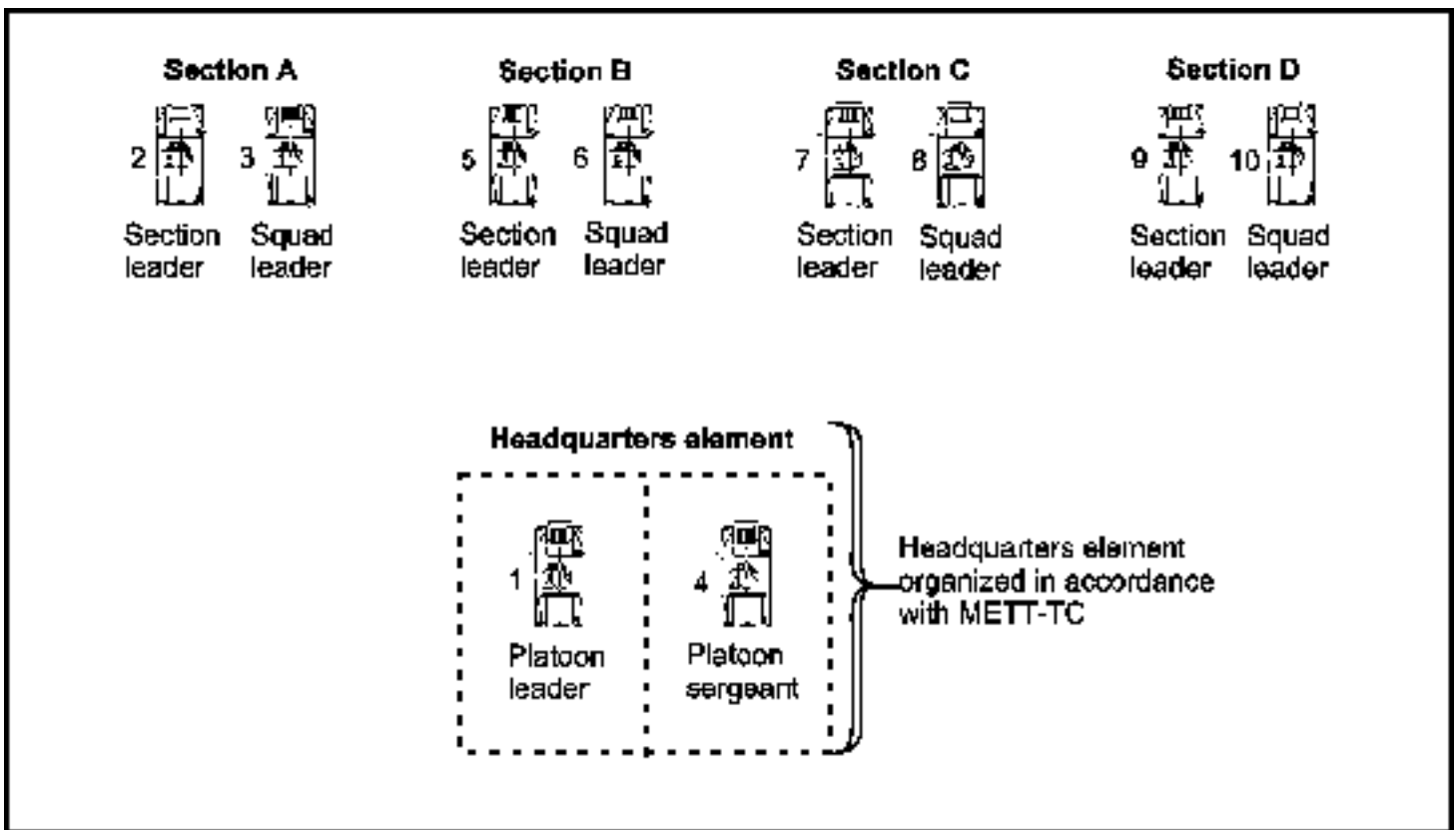

Figure 1-8. HMMWV scout platoon four-section organization.

Eight-squad organization

The eight-squad organization is rarely used because it creates very difficult command and control challenges. It gives the platoon an enhanced ability to conduct screening missions in depth, although only for short durations. It also provides the platoon with the ability to conduct numerous reconnaissance tasks simultaneously.

In addition to command and control, this organization has two severe drawbacks: the lack of overwatch capability leaves elements extremely vulnerable to enemy contact, and the platoon has virtually no ability to organize patrols of any type.

TASK ORGANIZATION

METT-TC circumstances will often cause the scout platoon leader to employ variations of the basic platoon organizations discussed previously. In addition, attachments, such as infantry or engineers, may change the composition and number of squads or sections. A CFV scout platoon with these assets attached may task organize into four squads or sections: two squads or sections consisting of one CFV and one infantry or engineer squad each and two squads or sections of two CFVs each (see [Figure 1-9](#)). Later chapters contain further information regarding mission task organization.

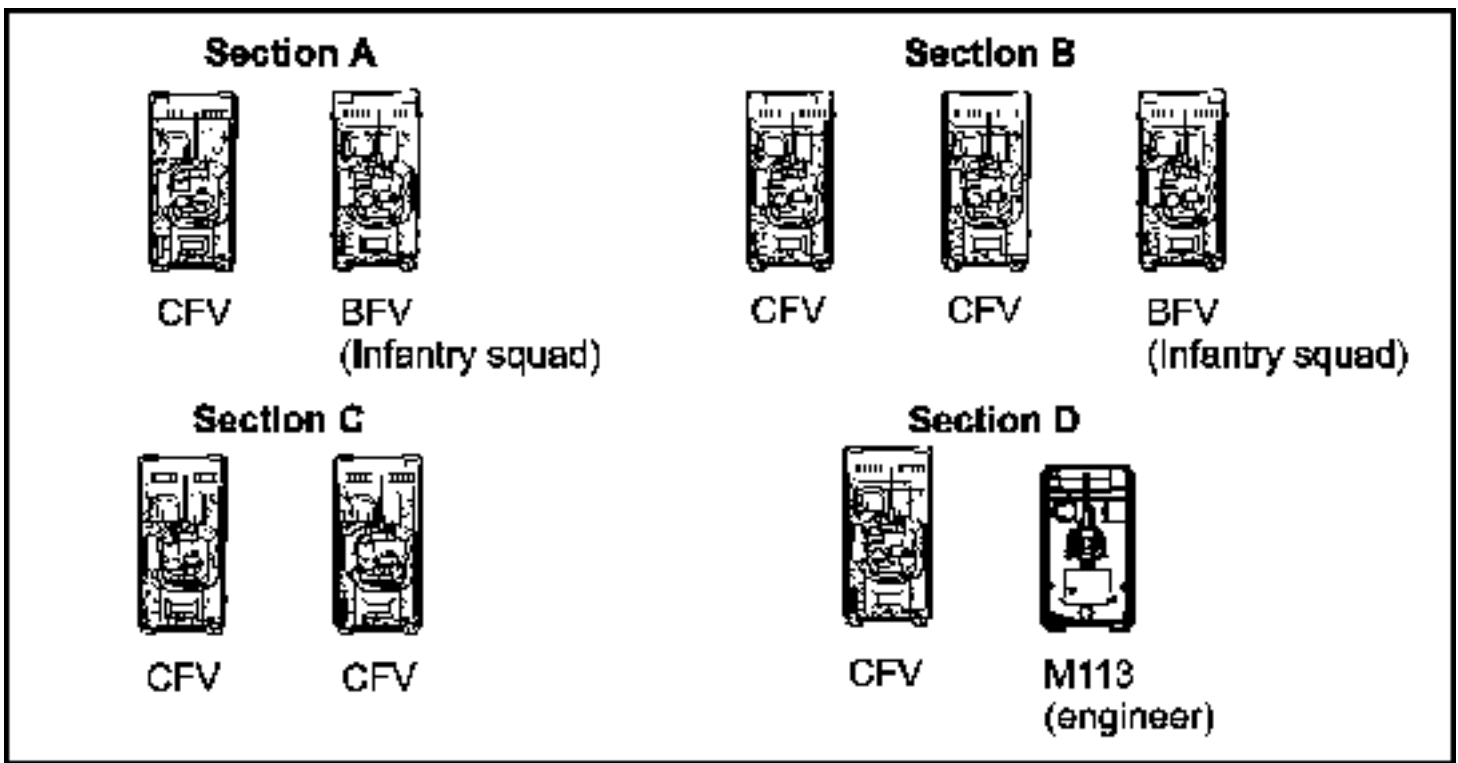

Figure 1-9. Example task organization with engineers and infantry.

SECTION 3 — RESPONSIBILITIES

The platoon leader and the platoon's noncommissioned officers (NCO) must be experts in the use of organic weapons, indirect fires, land navigation, supporting fires, demolitions, obstacles, communications, and reconnaissance and security techniques. They must be familiar with armor and infantry tactics and be able to react to rapidly changing situations; they must also know how to employ combat support (CS) assets that are attached to the platoon. Because of the many missions the platoon must be capable of performing, the scout platoon leader and PSG must be proficient in tasks at all skill levels of MOS 19D.

PLATOON LEADER

The platoon leader is responsible to his higher commander for the discipline, combat readiness, and training of the platoon as well as the maintenance of its equipment. The platoon leader must have a thorough knowledge of reconnaissance and security tactics. In the battalion scout platoon, as the task force's expert on reconnaissance and security, he works closely with the commander, S2, and S3 during the mission analysis portion of the planning process.

The platoon leader must be proficient in the tactical employment of the platoon. A solid understanding of troop-leading procedures and the ability to apply them quickly and efficiently in the field are essential. The platoon leader must also know the capabilities and limitations of the platoon's personnel and equipment. He must be an expert in enemy organizations, doctrine, and equipment.

Most of all, the platoon leader must be versatile. He must be able to exercise sound judgment and make correct decisions quickly based on his commander's intent and the tactical situation.

PLATOON SERGEANT

The PSG leads elements of the platoon as directed by the platoon leader and assumes command of the platoon in the absence of the platoon leader. During tactical operations, he may assist in the control of the platoon. The PSG assists the platoon leader in maintaining discipline, as well as in training and controlling the platoon. He supervises equipment maintenance, supply operations, and other combat service support (CSS) activities.

SECTION AND SQUAD LEADERS

Section leaders are responsible to the platoon leader for the training and discipline of their scout sections. They are also responsible for the tactical employment and control of the section. They are responsible for the maintenance and operation of all vehicles and equipment organic to their sections. Squad leaders have the same responsibilities for their squads as section leaders have for sections.

SECTION 4 — MISSIONS, CAPABILITIES, AND LIMITATIONS

MISSIONS

The scout platoon's primary missions are reconnaissance and security in support of its parent unit. It can perform these missions mounted or dismounted, day or night, in various terrain conditions, and under all weather and visibility conditions. In addition to the primary missions, the scout platoon can perform the following missions:

- Conduct liaison.
- Perform quartering party duties.
- Provide traffic control.
- Conduct chemical detection and radiological survey and monitoring operations as part of a nuclear, biological, and chemical (NBC) defense.
- Conduct limited obstacle construction and reduction.

CAPABILITIES AND LIMITATIONS

The scout platoon is a reconnaissance force that conducts operations as part of a larger combined arms force. Scouts in general have capabilities and limitations that must be considered when employing them; each type of scout platoon has characteristics specific to its TOE. Characteristics of the two main types of scout platoon (CFV and HMMWV) include the following:

- The scout platoon is dependent on its parent unit for CS and CSS.
- The CFV scout platoon normally reconnoiters only a single route during route reconnaissance.
- The HMMWV scout platoon can reconnoiter one or two routes simultaneously; however, reconnaissance of two routes can be performed to determine trafficability only.
- Depending on METT-TC, the scout platoon can reconnoiter a zone up to 3 to 5 kilometers wide. METT-TC may increase or decrease the size of the zone for either type of platoon.

- During screening operations, all scout platoons are limited in their ability to destroy or repel enemy reconnaissance units.
- The CFV scout platoon can man up to six OPs for short durations (less than 12 hours) or three OPs for long durations (over 12 hours).
- The HMMWV scout platoon can man up to eight short-duration OPs or up to three OPs for long durations.
- When properly organized, scouts can conduct effective reconnaissance and security patrols. The CFV scout platoon has 12 dedicated dismounted scouts. The HMMWV scout platoon has very limited dismounted capability; it must be carefully task organized to conduct dismounted operations.
- Distance and mission duration are critical considerations affecting employment of the scout platoon away from the main body of its parent unit. Fire support, CSS, and communications requirements are also important factors when the scout platoon is tasked to conduct sustained operations beyond the immediate supporting range of the main body.
- While operating on the platoon net, the scout platoon leader can monitor only two nets at one time. This means he cannot operate continuously on all necessary battalion nets, including the battalion command, operations and intelligence (OI), administrative/logistics (A/L), and mortar nets. Refer to the discussion of platoon radio nets in [Chapter 2](#) of this manual.
- The scout platoon has limited obstacle construction ability and carries only a basic load of demolitions.
- The scout platoon has very limited obstacle reduction capability; under most conditions, it can breach only point obstacles.

SPECIFIC SCOUT VEHICLE CHARACTERISTICS

In many respects, the scout's capability is dependent on his equipment. The two types of scout platforms, the M3 CFV and the M1025/1026 HMMWV, have distinctly different characteristics. When employed with the appropriate TTP, both vehicles are highly effective reconnaissance and security platforms.

Every scout must understand his mount thoroughly so he can maximize its capabilities and minimize its limitations. Refer to [Figures 1-10](#) and [1-11](#), which illustrate the two scout vehicles and summarize their capabilities and specifications.

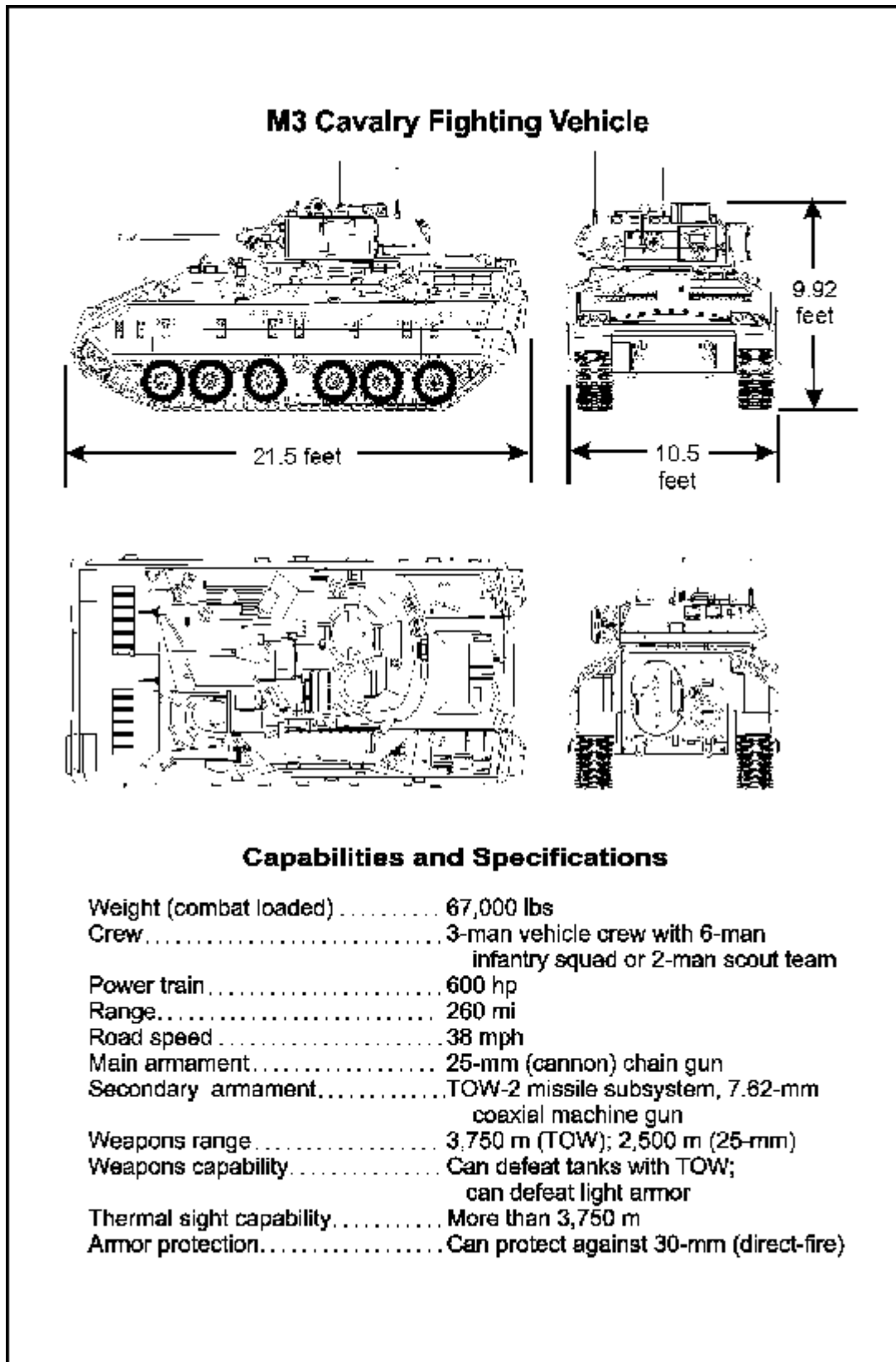

Figure 1-10. M3 CFV characteristics

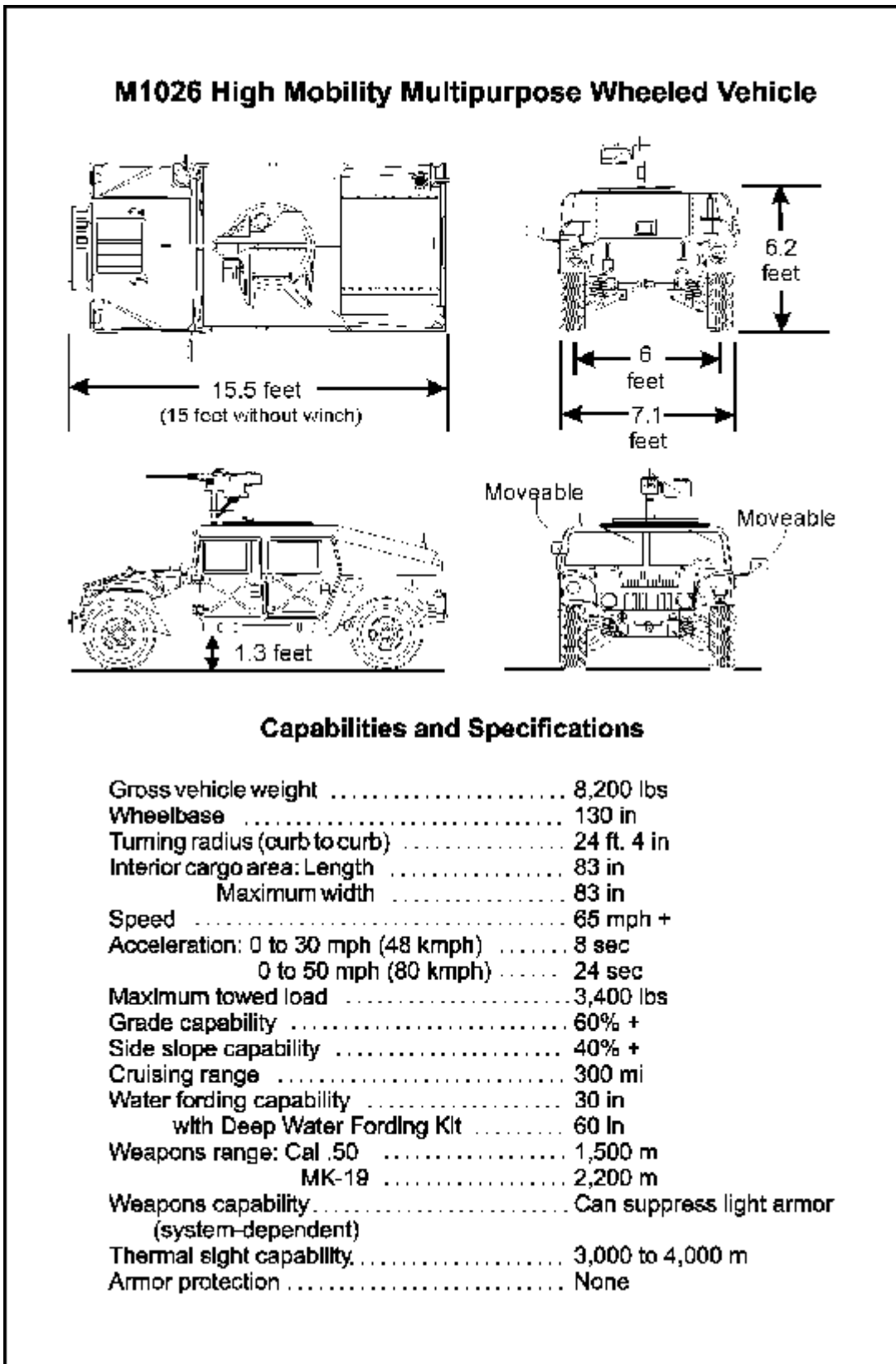

Figure 1-11. HMMWV characteristics

CHAPTER 2

Battle Command

Battle command is the process that leaders use to assimilate thousands of bits of information and then to visualize the battlefield, assess the situation, and direct military action required to achieve victory. Thinking and acting are simultaneous activities for leaders in battle.

The actions inherent in the command and control of combat elements on the modern battlefield are the biggest challenges faced by combat leaders. Command involves directing elements; control entails the steps taken to ensure that the directions are carried out. The greatest tactician in the world would be ineffective if he did not properly use the methods available to direct and control his combat elements. Command and control must be kept extremely simple to be effective.

The scout platoon leader leads his platoon and is assisted by the PSG. He uses a variety of techniques to plan operations, issue orders, employ the platoon, and communicate. At platoon level, effective use of command and control is a function of several critical factors: leadership, training, a sound and thoroughly understood standing operating procedure (SOP), and the tactically sound employment of control measures and communications equipment and techniques.

As noted, the scout platoon's primary functions are to gather information (reconnaissance) and perform limited security missions. Except when it is operating as a part of a larger force, the platoon is not organized and equipped to undertake operations that entail a significant offensive component, such as counterreconnaissance, armed reconnaissance, reconnaissance by fire, reconnaissance in force, or target acquisition. The unique information-gathering capabilities of the scout platoon at the task force level should be preserved by limiting direct contact with the enemy force to that necessary for self-defense.

CONTENTS

<u>Section 1</u>	<u>Command Relationships</u>
<u>Section 2</u>	<u>Intelligence Preparation of the Battlefield</u>
<u>Section 3</u>	<u>Troop-Leading Procedures</u>
<u>Section 4</u>	<u>Situational Awareness</u>
<u>Section 5</u>	<u>Navigation</u>
<u>Section 6</u>	<u>Communications</u>

SECTION 1 — COMMAND RELATIONSHIPS

BATTALION SCOUT PLATOON

In an armor or mechanized infantry battalion, the scout platoon performs several critical tasks in support of the battalion commander's concept of the operation. The success or failure of the scout platoon often has a direct impact on the success or failure of the main force. As the eyes and ears of the battalion, the scout platoon leader must stay in communication with the battalion tactical operations center (TOC). This is necessary to keep the platoon informed of the battalion and brigade situation as well as the current enemy situation and to ensure information gained by the platoon is transmitted to the battalion in a timely manner.

The battalion commander must make his intent clear to the scout platoon leader. The commander must ensure that his initial operation order (OPORD) and any following fragmentary orders (FRAGO) focus the scout platoon on its mission by telling the platoon leader what is expected of the reconnaissance or security effort in each phase of the operation. The intent includes the commander's criteria for recovering the scouts. He must make it clear whether he intends for the scouts to conduct stay-behind operations after the enemy main body has passed their locations or to pass through friendly lines before the arrival of the enemy main body.

The commander also specifies priority intelligence requirements (PIR), covering the information for which he has an anticipated and stated priority in his task of planning and decision-making. Often stated in question form, PIR are the tactical and operational considerations that are the foundation for development of the battalion reconnaissance and surveillance (R&S) plan.

In turn, the scout platoon leader needs to understand how he and his platoon fit into the R&S intelligence collection process. He works closely with the S2, who is a key player in the development of the R&S plan and the intelligence preparation of the battlefield (IPB) process. The S2's planning for R&S and IPB is further enhanced through an integrated staff effort to ensure that all R&S assets, including the scout platoon, receive adequate support to accomplish their missions. (**NOTE:** Refer to [Section 2](#) of this chapter for a discussion of the IPB process, including the role of PIR.)

The battalion executive officer (XO) and S4, as well as the headquarters company commander and XO, must monitor the maintenance and logistical status of the scout platoon. To help sustain the platoon's operational capability, they should ensure that the scouts receive top priority for repair and resupply. They should specifically address medical evacuation and vehicle recovery. They must ensure that the battalion has a detailed and workable plan to support the platoon's requirements in Classes I, III, and V during the conduct of its mission.

CAVALRY TROOP SCOUT PLATOON

The command relationship of the scout platoon in a cavalry troop is similar to that of other platoons in a company-size organization. The scout platoon responds to its platoon leader, who receives guidance from the troop commander rather than from a battalion staff.

The primary difference in cavalry troop operations is the role of the troop XO. Unlike the "fighting XO" in the tank company, the troop XO is a battlefield manager for the troop commander. He operates from an M577 command post; this vehicle gives him the communications capability and facilities to receive, collate, and pass to higher headquarters the routine reconnaissance information processed by the troop's

scout platoons. In this system, most of the routine reports are sent to the troop XO rather than to the troop commander. The troop commander's role is to monitor the routine actions, receive high-priority information to transmit on command nets, and fight the troop once contact is gained.

SECTION 2 — INTELLIGENCE PREPARATION OF THE BATTLEFIELD

IPB is a systematic, continuous process of analyzing the effects of the threat and the environment on the unit. It is a dynamic staff process, driven by the commander, that continually integrates new information into the unit's operational framework.

WHAT IPB ACCOMPLISHES

IPB identifies facts and clarifies assumptions about the enemy and the battlefield environment. The commander and his staff use the IPB process to analyze the enemy, weather, and terrain to determine and evaluate the enemy's capabilities, vulnerabilities, and probable courses of action (COA). The resulting information serves the following purposes:

- It facilitates staff planning and development of potential friendly COAs for the operation.
- It provides the basis for directing and synchronizing the R&S effort that supports the commander's chosen COA.
- It contributes to thorough staff synchronization and successful completion of several staff processes.
- In turn, it helps the commander to selectively apply and maximize his combat power at critical points in time and space on the battlefield.

The most critical mission of the scout platoon is to gather information on enemy forces that the S2 then uses to assess enemy disposition and intentions. IPB is a disciplined staff procedure that provides the scout platoon leader with formal guidance in the form of reconnaissance objectives and PIR, as contained in the R&S plan; the platoon leader then applies this information in accomplishing the platoon's assigned reconnaissance tasks.

[Figure 2-1](#) illustrates the various phases and components of the information-gathering process, including IPB.

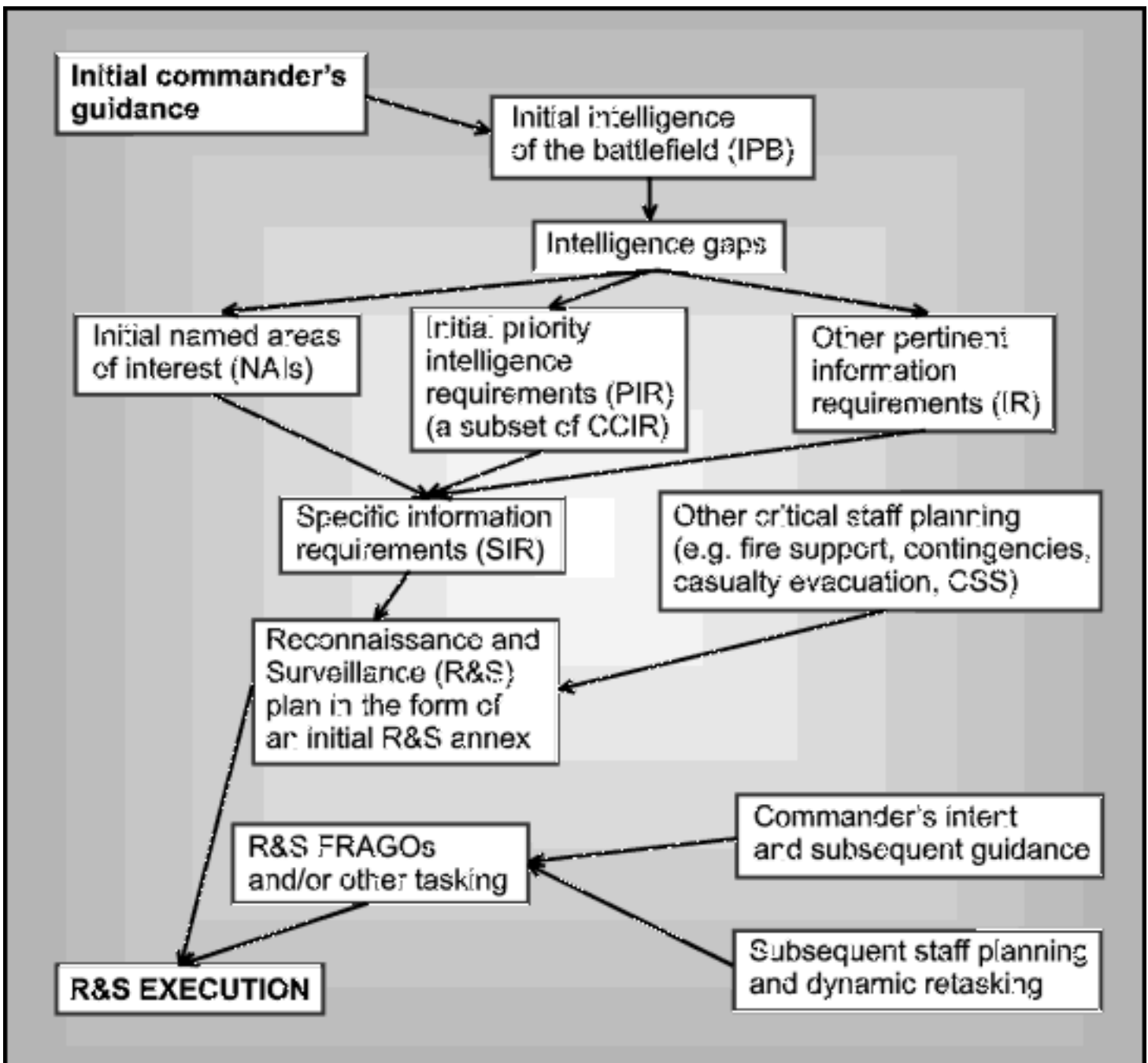

Figure 2-1. The information-gathering process.

THE IPB PROCESS

The first step of the IPB process is to define the battlefield environment. This step focuses the staff on the requirements of the initial R&S effort. During this step, the S2 takes the following actions:

- Identify battlefield characteristics, such as terrain and weather, that will influence friendly and enemy operations and that require evaluation through the IPB process.
- Establish the area of interest (AI) to focus the IPB analysis and the R&S effort.
- Identify gaps in current intelligence holdings that become the initial information requirements.

Step 2 is to define the battlefield's effects. This step identifies general limitations that the environment imposes on friendly and enemy forces, as well as the tactical opportunities it offers. IPB products

developed during this step focus on these effects; they include, but are not limited to, the following:

- Population status overlay.
- Overlays that depict the military aspects and effects of terrain (such as the factors of OCOKA).
- Weather analysis matrix.
- Integrated staff products such as the modified combined obstacle overlay (MCOO).

Step 3 of IPB is to evaluate the threat; it includes analysis of current intelligence holdings to determine how the enemy normally organizes for and conducts combat operations. The results are portrayed using threat models that depict how the enemy fights; these are the only products associated with this step. Although they usually emphasize graphic representation of the enemy situation (such as doctrinal templates with high-value targets), threat models sometimes entail use of matrices, simple narrative descriptions, and depictions of enemy obstacle systems.

Step 4 is to determine threat COAs. This step integrates the results of the first three steps of IPB into a meaningful summary of likely objectives and COAs available to the enemy. IPB products, which are valid only if the S2 establishes a solid foundation during the first three steps, include these:

- Models that depict the enemy's available COAs. These are normally produced in the form of situation developments; they may include associated matrices and/or text descriptions.
- Event templates and related matrices to focus the R&S effort.

FRIENDLY COA DEVELOPMENT AND WAR-GAMING

During threat COA development, the staff concurrently develops friendly COAs based on the facts and assumptions identified during IPB and mission analysis. Incorporating the results of IPB into COA development ensures that each friendly COA takes into account the opportunities and limitations related to the environment and the threat situation.

During the war-gaming session, the staff fights the set of threat COAs, developed in [step 4](#) of the IPB process, against each potential friendly COA. Targeting conferences often accompany or follow the war-gaming session to refine selected high-value targets (HVT) from the enemy COA models into high-priority targets (HPT) that support the friendly COAs.

Based on the results of war-gaming, the staff takes the following actions to finalize the COA development process:

- Construct a decision support template (DST) and its associated matrix.
- Identify information requirements for each COA.
- Refine enemy COA models and event templates (and their related matrices), focusing on the intelligence required to execute the friendly COAs.
- For each threat COA, determine the probability that the enemy will adopt it.
- Identify the most dangerous threat COA.

After deciding on a COA and issuing orders, the commander approves a list of information requirements; he identifies the most important of these as the final PIR. During execution of the operation, emerging intelligence will confirm or deny the assumptions and information identified during the initial IPB.

The S2 continues to evaluate the situation and update the commander and staff. As necessary, he performs parts of the IPB process to support new iterations of the decision-making process. Refer to [Figures 2-2](#), [2-3](#), and [2-4](#) for examples of the templates developed during IPB and the war-gaming of friendly COAs.

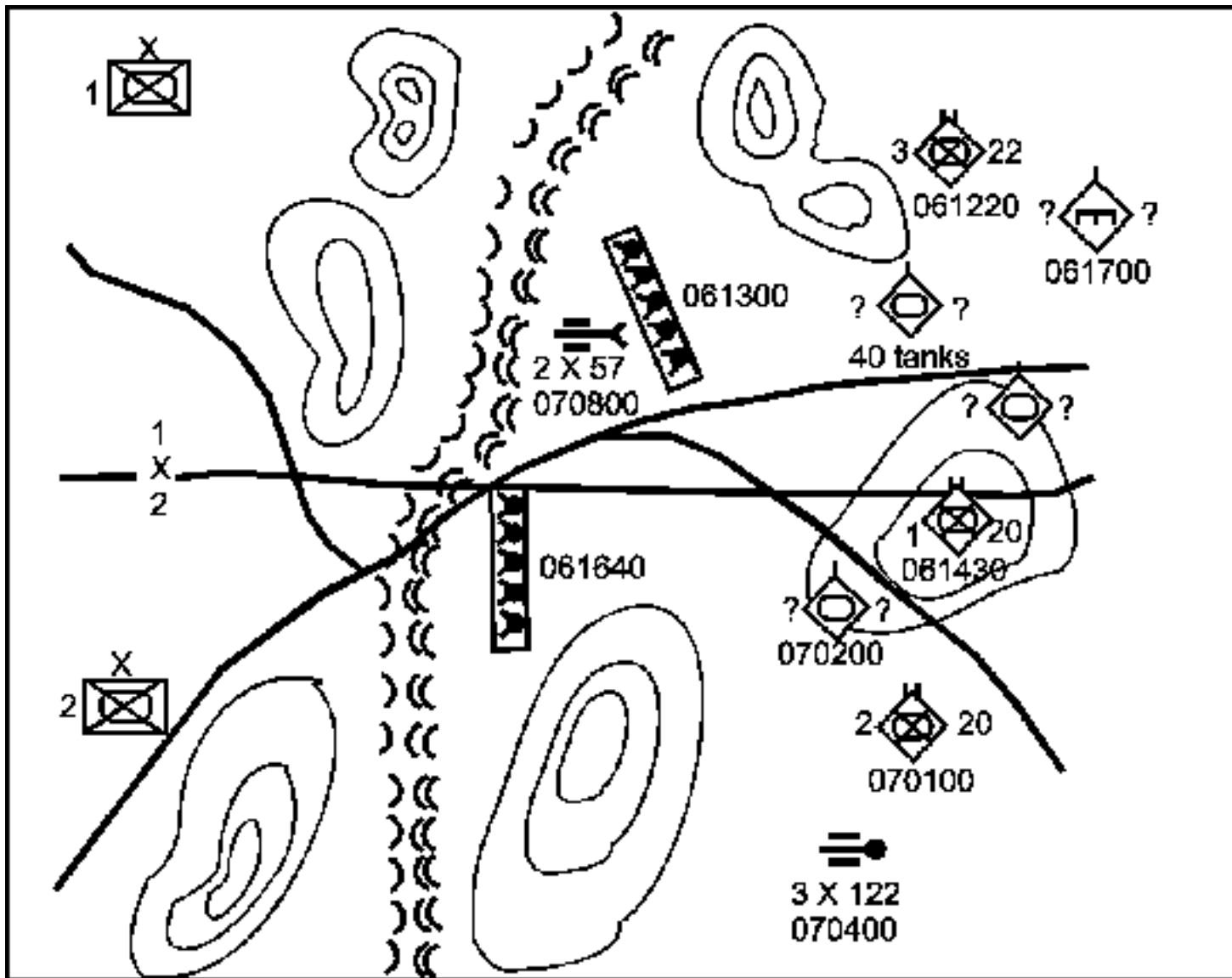

Figure 2-2. Example situational template.

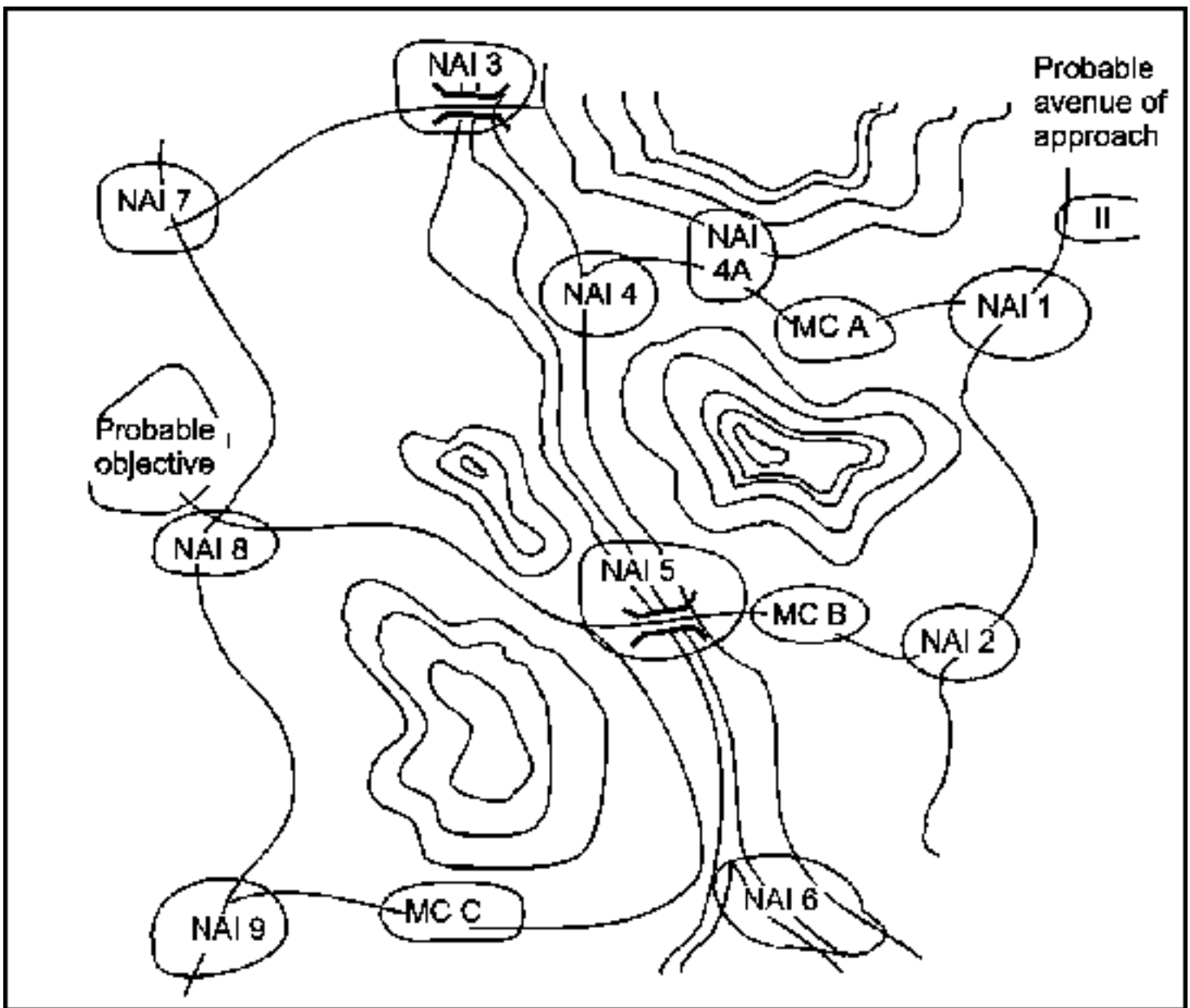

Figure 2-3. Example event template.

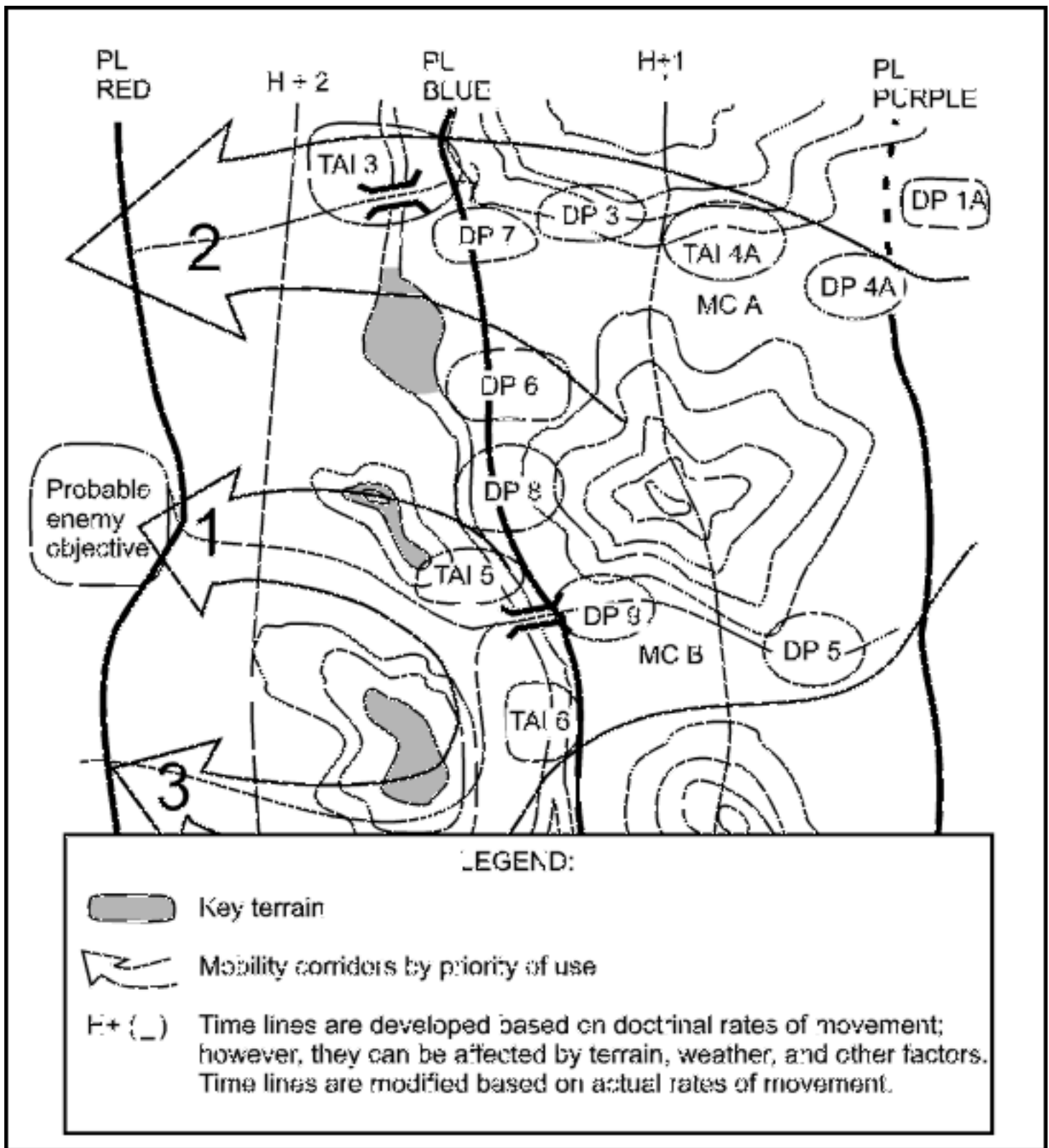

Figure 2-4. Example decision support template.

Development of the R&S plan

The key purpose of the R&S plan is to organize the collection of information the commander needs to fight and win the battle. A maneuver brigade and its assigned battalions will all produce R&S plans. The brigade plan will task the subordinate battalions, and these tasks will be incorporated into the battalion plan. [Figure 2-1](#) shows how the R&S plan is developed within the overall information-gathering process.

From the decision support template, the S2, in coordination with the S3, prepares the detailed battalion R&S plan, which graphically depicts where and when reconnaissance elements should look for enemy forces (see [Figure 2-5](#)). The S2 should brief the R&S plan to the scout platoon leader, ensuring that the platoon leader understands all R&S objectives.

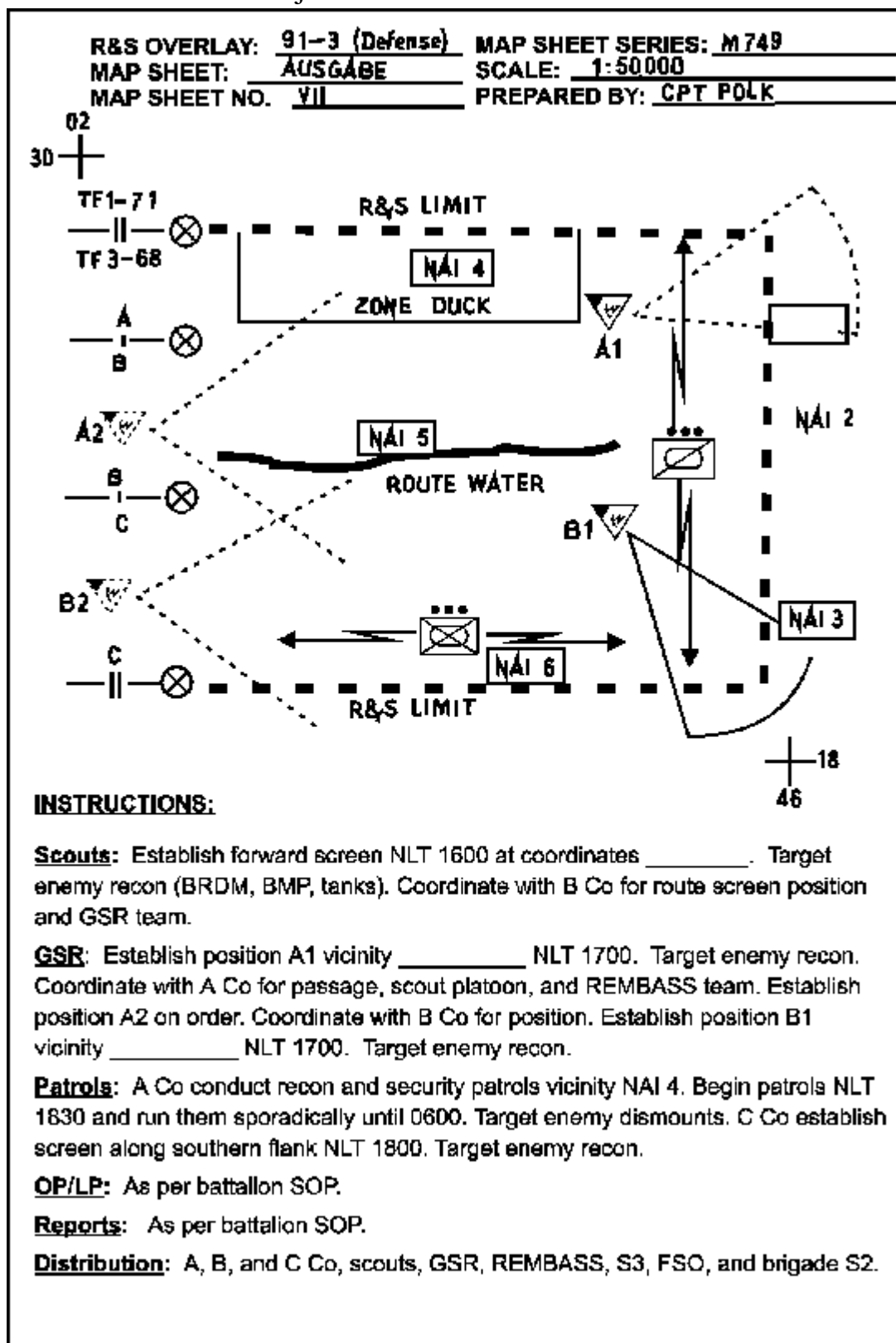

Figure 2-5. Example reconnaissance and surveillance plan.

The S2 uses an R&S tasking matrix to coordinate all available assets for R&S operations (see [Figure 2-6](#)). The R&S plan must direct specific tasks and priorities to all R&S elements, including company teams, scout platoons, GSR, and patrols.

(CLASSIFICATION)														
DTG: _____														
MISSION: _____														
P R N O.	N A I	START / STOP	SIR/ INSTRUCTIONS	A	B	C	D	S C O U T S	M O R T A R S	G S R	R E M A R K S	O T H E R	C O O R D I N A T I O N	R E P O R T S
1	1.	1600	When, where, and what type of equipment does the recon element have?					X					Coordinate with B Co for route to screen position. Coordinate with GSR team.	
1	2.	1800	How is the enemy infiltrating, on foot or vehicle? Speed and direction of movement?							X			Coordinate with A and B Co for passage to positions with scout platoon. For alternate sites, coordinate with B and C Co.	
1	4	1830 0630	Conduct zone reconnaissance in ZONE DUCK. How is the enemy reconnoitering on the northern flank? Strength and equipment? Will enemy attack northern flank?	X									Coordinate with GSR team and scout platoon.	
(CLASSIFICATION)														

Figure 2-6. Example R&S tasking matrix.

R&S tasking, which is handled by the S3, can take the form of a warning order, OPORD, R&S tasking matrix, or R&S overlay. The S3 translates the R&S plan into operational terms and graphics. For example, in preparation for reconnaissance operations, the S3 designates NAIs in terms of reconnaissance objectives for the scout platoon. The scout platoon leader designates checkpoints as control measures to guide his platoon's movement to these objectives.

NOTE: The R&S plan is developed very early in the planning process because it is important to integrate the scout platoon with other information-gathering assets, such as ground surveillance radar (GSR) and engineer reconnaissance teams. Because reconnaissance is a continuous and dynamic process, the scout platoon is committed as soon as possible in accordance with the commander's intent and reconnaissance objectives. Deployment of the scout platoon should not be delayed until the R&S plan has been formulated.

Role of staff and supporting elements

Battalion S3. The S3 should brief the scout platoon leader on disposition of friendly forces and the battalion scheme of maneuver. To support additional graphics and FRAGOs, the S3 provides the platoon leader with current (and projected) R&S and operational graphics and terrain index reference system (TIRS) points. (**NOTE:** Use of TIRS is an optional technique.) If the commander does not personally brief the platoon leader, the S3 must ensure that he accurately portrays the commander's intent and that platoon leader fully understands the intent.

In briefing the scout platoon leader, the S3 should cover employment of the scouts through the entire

course of the mission. He should provide guidance on when the platoon will report, what actions it will take on enemy contact, and what CS assets are available. The S3 also reinforces the S2's guidance. The scout platoon leader should receive the S3's briefing before he departs the battalion area for his mission. He may also receive it as a FRAGO over the radio or from a messenger sent by the commander.

Fire support. To ensure it can provide responsive fire support to the scout platoon, the fire support element (FSE) stays abreast of what the platoon is doing throughout the conduct of the mission. The scout platoon leader should coordinate with the fire support officer (FSO) to discuss his mission and the platoon's unique fire support requirements. The platoon leader finds out what support is available, where supporting units are located, and what fire support restrictions exist. He will then recommend preplanned targets and target priorities to be incorporated by the FSO into a scout platoon fire support plan. The platoon leader should depart the FSE with an approved target list and/or overlay.

Signal. The battalion signal officer (S6) must conduct additional coordination with the scout platoon leader if the mission requires communications support. The scout platoon leader must request retransmission (retrans) or relay support from the battalion signal platoon if the mission dictates. Scouts should not perform relay duties as their primary platoon mission.

Other elements. The scout platoon leader also coordinates support with any attached or assigned elements; examples include engineer reconnaissance teams, air defense artillery (ADA), combat observation lasing team (COLT), GSR, and aeroscouts. This support is normally coordinated by the S3, but the platoon leader should be aware of how changes to the organization affect his platoon. Ideally, linkup with support elements should occur at the TOC in daylight with sufficient time to conduct thorough briefings and rehearsals.

PLATOON IPB EXECUTION

When the scout platoon leader leaves the TOC area to prepare for his mission, he should, as a minimum, have the following materials:

- Operational and R&S graphics.
- The situational template, event template, and notes on the current enemy situation.
- Fire support overlay.

Once in the vicinity of its mission objectives, the scouts confirm or deny the templated information. Additionally, if they find the enemy, the scouts look for possible weaknesses, gaps, and flanks of the enemy position. During screening operations, the S3 directs the scout platoon leader to report enemy activity at designated NAIs. The scout platoon leader uses OPs to observe and report on these areas of command interest. The scouts must rapidly and accurately report all information related to the commander's critical information requirements (CCIR) that they find during either reconnaissance or screening operations.

SECTION 3 — TROOP-LEADING PROCEDURES

THE MILITARY DECISION-MAKING PROCESS

Decisions are the means by which a commander or leader translates the information available to him and his vision of the desired end state of an operation into the actions necessary to achieve that end state. Decision-making is a conscious process for selecting a COA from two or more alternatives. As noted in [FM 101-5](#), it is a learned skill of knowing *if* to decide, then *when* and *what* to decide. The process includes an understanding of the consequences of each decision.

The military decision-making process (MDMP) is the Army's adaptation to this analytical approach to decision-making and problem-solving. It provides the commander or leader with a valuable tool in developing his estimate of the situation and his plan. Although the process begins with the receipt of the mission, the analytical aspects of the MDMP continue at all levels throughout the operation. Refer to [FM 101-5](#) for a detailed examination of the MDMP.

At platoon level, many actions associated with the MDMP are based on SOPs and standard unit drills; these include evacuation of wounded soldiers, rearming and resupply procedures, and individual crew responsibilities. This allows the platoon to operate quickly and efficiently without constant guidance from the platoon leader. SOPs are especially critical in helping to maintain combat preparedness when leaders are tired as a result of the stress of continuous operations. Because SOPs are so critical, it is absolutely necessary that everyone in the platoon know and understand them. Refer to [FKSM 17-98-3](#) for a sample platoon-level SOP applicable for both the battalion scout platoon and the cavalry troop scout platoon.

THE STEPS OF TROOP-LEADING PROCEDURES

Troop-leading procedures are the basis of the dynamic process (illustrated in [Figure 2-7](#)) by which units develop plans and orders at every level of leadership. The process, although discussed here with the eight steps in traditional order, is not rigid, and the steps are not necessarily sequential. The tasks involved in some steps (such as initiate movement, issue the warning order, and conduct reconnaissance) may recur several times during the process. Although listed as the last step, activities associated with supervising and refining the plan and other preparations occur throughout troop-leading.

Troop-leading procedures begin when the platoon leader receives the first indication of an upcoming operation (often by warning order from higher) and continue throughout the planning, preparation, and execution phases of the mission. The platoon leader maximizes the available planning time by starting as soon as the first bit of information becomes available. He normally uses one-third of the available time to plan, prepare, and issue the order; his TCs then have the remaining two-thirds of the time available to

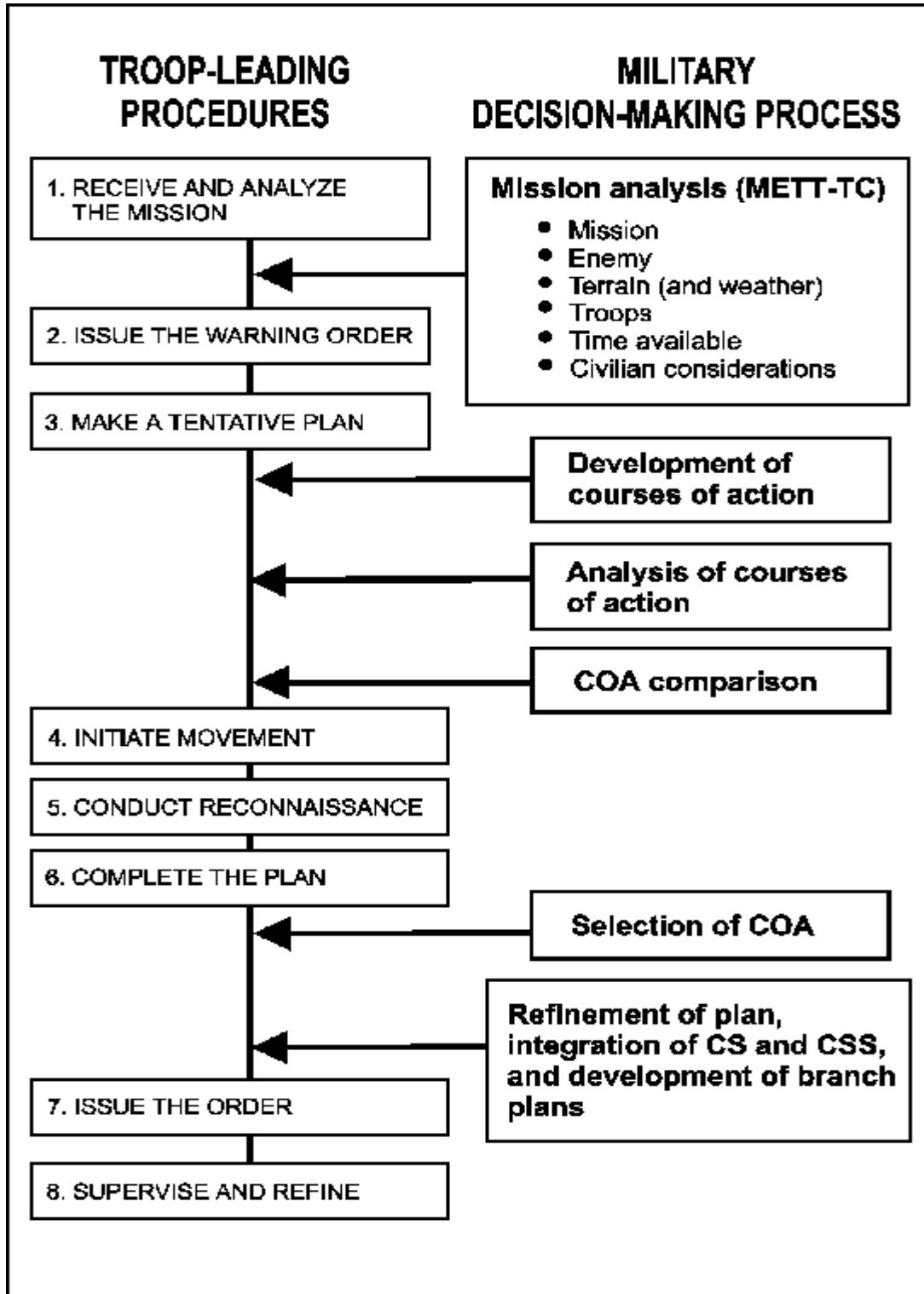

Figure 2-7. Relationship of troop-leading procedures and the military decision-making process.

conduct their own troop-leading procedures. This time allocation is known as the "one-third/two-thirds" rule of planning and preparation.

[Figure 2-7](#) lists the eight troop-leading steps and illustrates their role in relation to the MDMP, which plays an important role in the troop-leading process. The following discussion provides a step-by-step overview of troop-leading procedures.

Step 1 - Receive and analyze the mission

The platoon leader normally receives his orders as an oral or written OPOD, as a FRAGO, or as a warning order. Upon receipt of the order, he begins analyzing the mission using the factors of METT-TC: mission, enemy, terrain (and weather), troops, time available, and civilian considerations. Mission analysis is a continuous process. The platoon leader constantly receives information during the planning phase and must decide if it affects his mission. If it does, he then decides how to adjust his plan to meet this new situation.

Initial actions. Although mission analysis is continuously refined throughout the troop-leading process, the platoon leader's initial actions are normally based only on the initial warning order from higher. These include an initial METT-TC analysis covering the terrain and enemy and friendly situations.

The platoon leader may also conduct his initial time analysis, develop an initial security plan, and issue his own initial warning order to provide guidance and planning focus for his subordinates. At a minimum, the initial platoon warning order should cover the enemy and friendly situations, movement instructions, and coordinating instructions such as an initial timeline and security plan. (**NOTE:** The initial analysis is normally conducted as quickly as possible to allow the platoon leader to issue the initial warning order in a timely manner. He then conducts a more detailed METT-TC analysis after the initial warning order is put out.)

NOTE: The technique of using multiple warning orders is a valuable tool for the platoon leader during the troop-leading process. He can issue warning orders for several purposes: to alert subordinates of the upcoming mission, to initiate the parallel planning process, and to put out tactical information incrementally as it is received (ultimately reducing the length of the OPOD). Refer to [FM 71-1](#) for a discussion of how warning orders are employed at various stages of the troop-leading procedures.

METT-TC analysis. The following discussion covers the six factors of METT-TC in detail. (**NOTE:** METT-TC factors are not necessarily analyzed sequentially. How and when the platoon leader analyzes each factor depends on when the information is made available to him.)

Mission. After receiving an essential task and purpose, either in a warning order or the OPOD, the platoon leader can then begin the analysis of his own mission. He may use a refined product to better visualize the interrelationships of the terrain, the enemy, and friendly forces. These may include a MCOO and/or the situational template (SITEMP), if available. The platoon leader's goal in this analysis is to clarify what the scout platoon is to accomplish and why the platoon must accomplish it. Key considerations in the analysis include the following:

- What is my task and purpose for this operation?
- What is the commander's intent?

- What are the specified tasks for the operation (those that the commander stated must be accomplished)? (**NOTE:** In the OPORD, these tasks are outlined in paragraph 3, which comprises the commander's intent, concept of the operation, tasks to subordinate units, and coordinating instructions.)
- What are the implied tasks for the operation? These are other tasks, not specifically noted by the commander, that must be accomplished during the operation.
- What are the essential tasks for the operation? These are all tasks, both specified and implied, that are absolutely required to ensure mission success.

Enemy. The platoon leader's analysis of the enemy situation should focus on the areas outlined in [FM 71-1](#) (doctrinal analysis and objectives, composition and disposition, capabilities, weaknesses, anticipated COAs, and factors that can influence these COAs). The analysis can focus on the following considerations:

- What types of enemy units is the platoon up against?
- Where are these units?
- What is the enemy doing?
- How strong is he?
- What kind of equipment does he have?
- What are his capabilities and weaknesses?
- Where is he vulnerable?
- Where are his kill zones and fire sacks?
- What are the enemy's intentions, doctrinal objectives, and most probable COA(s)?
- What can he do in response to friendly actions?

Terrain (and weather). The platoon leader analyzes the terrain using the factors of OCOKA: observation and fields of fire; cover and concealment; obstacles; key terrain; and avenues of approach. The following discussion focuses on questions the platoon leader can use in his analysis.

Observation and fields of fire. The platoon leader should cover the following considerations in his analysis:

- Where can the enemy observe and engage my platoon?
- Where can I establish OPs to maximize my ability to see the battlefield?

Cover and concealment. The platoon leader should include the following considerations in his analysis of cover and concealment:

- What routes within the area of operations offer cover and concealment for my platoon or for enemy elements?
- What dismounted routes offer my platoon the best available cover and concealment?

Obstacles. In analyzing the terrain, the platoon leader first identifies existing and reinforcing obstacles that may limit mobility (affecting such features as objectives, avenues of approach, and mobility corridors).

Existing obstacles include, but are not limited to, the following:

- Gullies, ravines, gaps, and ditches over 3 meters wide.
- Streams, rivers, and canals over 1 meter deep.
- Mountains or hills with a slope in excess of 60 percent.
- Lakes, swamps, and marshes over 1 meter deep.
- Tree stumps and large rocks over 18 inches high.
- Forest or jungles with trees 8 inches or more in diameter and with less than 4 meters of space between trees.
- Man-made existing obstacles, including built-up areas such as towns, cities, or railroad embankments.

Reinforcing obstacles include, but are not limited to, the following:

- Minefields.
- Antitank ditches.
- Road craters.
- Abatises.
- Wire obstacles.

Based on the degree of obstruction posed by obstacles, terrain is further classified in one of the following categories:

- **Unrestricted.** This is terrain that is free of any restriction to movement; no actions are required to enhance mobility. For mechanized vehicles, unrestricted terrain is typically flat or moderately sloped, with scattered or widely spaced obstacles such as trees or rocks. This type of terrain generally allows wide maneuver and offers unlimited travel over well-developed road networks.
- **Restricted.** This is terrain that hinders movement to some degree. Little effort is needed to enhance mobility, but units may have to zigzag or make frequent detours. They may have difficulty maintaining optimum speed, moving in some types of combat formations, or transitioning from one formation to another. For mechanized vehicles, restricted terrain typically encompasses moderate to steep slopes and/or moderate to dense spacing of obstacles such as trees, rocks, or buildings. Swamps and rugged ground are examples of restricted terrain for dismounted infantry forces. Logistical or rear area movement in this type of terrain may be hampered by poorly developed road systems.
- **Severely restricted.** Terrain in this classification severely hinders or slows movement in combat formation unless some effort is made to enhance mobility. This could require commitment of engineer forces to improve mobility or deviation from doctrinal tactics, such as using a column rather than a line formation or moving at speeds much lower than otherwise preferred. Severely restricted terrain for mechanized vehicles is typically characterized by steep slopes, densely spaced obstacles, and/or the virtual absence of a developed road system.

Key terrain. Key terrain is any location or area whose seizure, retention, or control affords a marked advantage to either combatant. The platoon leader's analysis should include these considerations:

- Where is the key terrain?
- How can the platoon use key terrain to support the mission?

Avenues of approach. These are areas through which a unit can maneuver. The definition of an avenue of approach is an area that provides sufficient ease of movement and enough width to allow passage of a force large enough to significantly affect the outcome of the battle. The platoon leader's analysis should include these considerations:

- Where are the most favorable mounted and dismounted avenues of approach for enemy and friendly forces?
- Where are the best air avenues of approach for enemy forces?

Weather. The platoon leader analyzes weather conditions as part of his evaluation of the terrain. The following considerations should be included in this evaluation:

- What are the light conditions (including percentage of night illumination) and visibility?
- What are the times for beginning of morning nautical twilight (BMNT), sunrise, sunset, end of evening nautical twilight (EENT), moonrise, and moonset?
- How has recent weather affected the area of operations?
- Will weather become better or worse during the mission?
- How will fog, rain, dust, heat, snow, wind, or blowing sand affect both friendly and enemy troops and equipment during the mission?

Troops. The platoon leader's analysis of troops available for an operation includes an assessment of the platoon's vehicles and equipment. Considerations in the analysis include the following:

- What is the present condition of the platoon's soldiers, vehicles, and equipment?
- What is the supply status of ammunition, fuel, and other necessary items?
- What is the state of training of the platoon?
- What is the state of morale?
- How much sleep have the men had?
- How much sleep can they get before and during the operation?
- Does the platoon need any additional equipment to support or accomplish its mission?
- What attachments does the platoon have (or require) to accomplish its mission?
- How many OPs (mounted/dismounted) can be manned with the available assets?
- How big a frontage can be covered with the available assets?

Time available. The platoon leader's analysis of the time available for an operation begins with the "one-third/two-thirds" rule of planning and preparation discussed earlier in this section. This principle allows the platoon leader to use one-third of planning and preparation time himself, then to allocate the remaining two-third to subordinates. Additional considerations in the analysis should include the following:

- How much time is available to plan and conduct reconnaissance?
- How much time is available for rearming, refueling, and resupply?
- How long will it take the platoon to move to planned OPs, to the line of departure (LD), and/or to the objective?
- Is there enough time for rehearsals?

- How much time is available to the enemy for the activities listed in the previous items?
- How does the potential enemy timeline for planning and preparation compare with that developed for friendly forces?

Civilian considerations. In his analysis of how the platoon will handle situations involving civilians (including stability and support operations), the platoon leader should assess the following considerations:

- What are the applicable rules of engagement (ROE) and/or rules of interaction (ROI)?
- What procedures and guidelines will the platoon use in dealing with refugees, prisoners, and other civilians?
- Will the platoon be working with civilian organizations, such as governmental agencies, private groups, or the media?
- Will the platoon be tasked to conduct stability operations (such as peace operations or noncombatant evacuation) or support operations (such as humanitarian or environmental assistance)?

Reverse planning and timeline development. After completing his METT-TC analysis, the platoon leader conducts reverse planning to ensure that all specified, implied, and essential tasks can be accomplished in the time available. He develops a reverse planning schedule (timeline), as illustrated in [Figure 2-8](#), beginning with actions on the objective; he works backward through each step of the operation and then through preparation and planning activities to the present time. This process also helps the platoon in making efficient use of planning and preparation time.

NOTE: Simultaneous planning and preparation are key factors in effective time management during the troop-leading process. The next five steps (issue a warning order; make a tentative plan; initiate movement; conduct reconnaissance; complete the plan) may occur simultaneously and/or in a different order. As noted, the final troop-leading step, supervise and refine, is on-going throughout the process.

Step 2 - Issue the warning order

After the platoon leader has analyzed his orders and worked out his mission and related tasks, he must quickly pass this information to his subordinate leaders. This is accomplished through the warning order. As a minimum, the following information must be included:

- Elements and individuals to whom the warning order applies.
- Enemy situation as stated in the task force order.
- The time and nature of the operation.

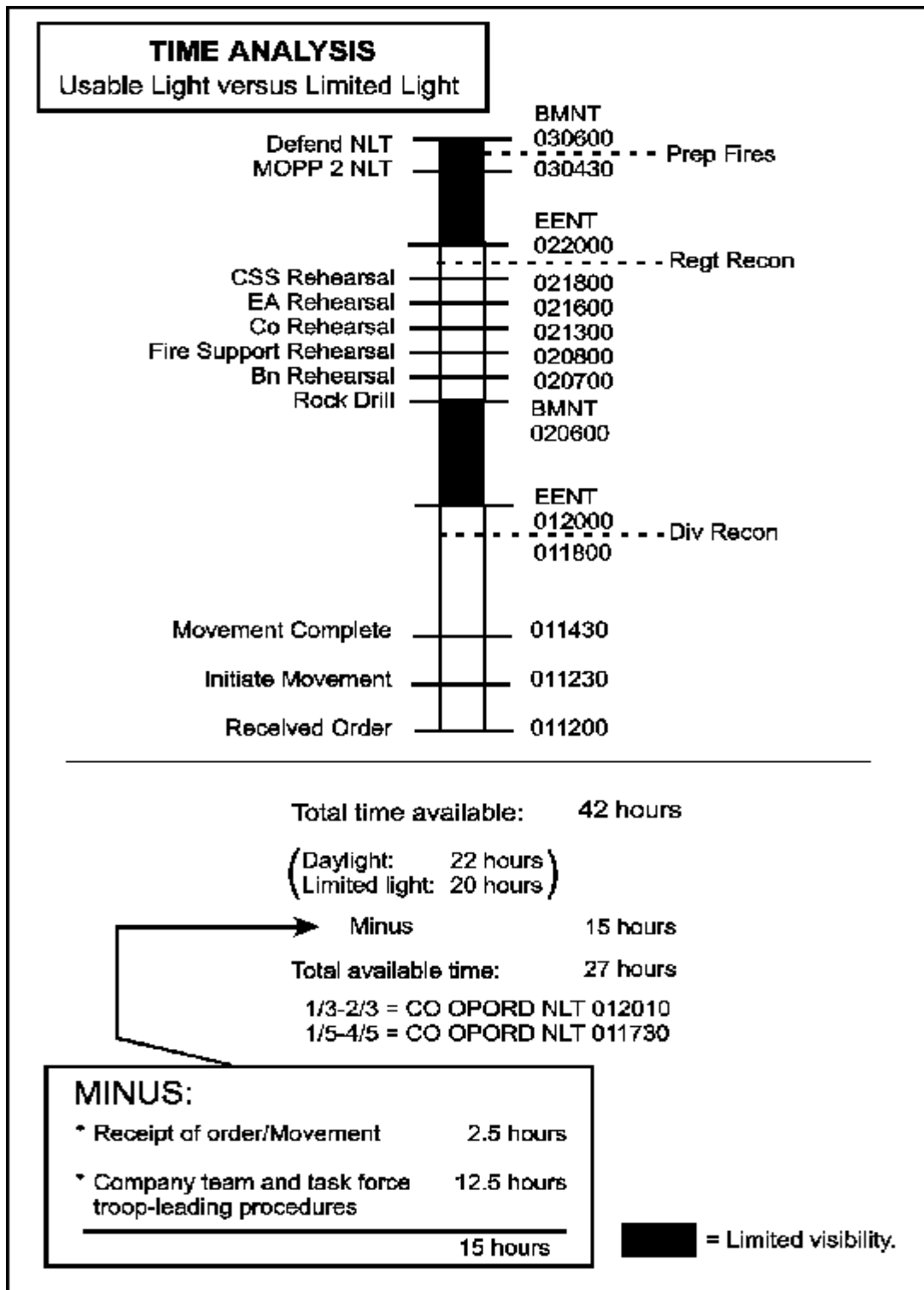

Figure 2-8. Example reverse planning timeline.

- The earliest time of movement.
- Coordinating instructions, including an initial timeline.
- The time and place the OPORD will be issued.

If possible, the platoon leader should issue an overlay of the area of operations. In the absence of further orders, this gives the platoon an idea of the scope of the operation. Also, the platoon leader should inform his subordinates of the results of his reverse planning process and delegate appropriate preparation tasks to the PSG and to the section and squad leaders. If possible, the platoon leader should also include the task organization of the platoon. In addition to accounting for all required preparatory tasks, the reverse planning schedule should include a sleep plan. All elements should acknowledge receipt of the warning order.

Step 3 - Make a tentative plan

Based on results of his mission analysis, the platoon leader develops a tentative plan that addresses all specified, implied, and essential tasks using the OPORD format (see [Appendix A](#) of this manual).

Step 4 - Initiate movement

After issuing a warning order and making a tentative plan, the platoon leader may choose to initiate movement. He may send a quartering party out to a new assembly area, or he may move his whole platoon to set up guides for the battalion movement. Whatever the case, the platoon leader should at least be able to determine when the platoon will move. He announces this in terms of a readiness condition (REDCON); refer to [FKSM 17-98-3](#) for more information on REDCON levels.

Step 5 - Conduct reconnaissance

This step of the troop-leading procedures allows the platoon leader to confirm the validity of his tentative plan and to refine the plan. The platoon leader should conduct the reconnaissance with his subordinate leaders. This will allow them to see the terrain and develop a better visualization of the projected plan. At a minimum, the platoon leader conducts this step as a detailed map reconnaissance. He should at least confirm his initial march route to the LD or start point (SP) and check initial positions. If possible, he should also check some of the area beyond the LD; this may require permission from the commander.

If the platoon leader cannot personally conduct on-site reconnaissance, he should make the most efficient use of available time by tasking his subordinates to accomplish specific reconnaissance requirements. An example of this is tasking a squad leader to reconnoiter and time routes to the SP. The platoon leader must conduct the reconnaissance with an open mind; not everything he sees will match his tentative plan. He must be flexible enough to change and competent enough to work out new plans rapidly.

Step 6 - Complete the plan

The platoon leader refines his plan based on the results of the reconnaissance. He then completes the plan using these results and any new information from the battalion or squadron commander, the higher headquarters staff, and members of his platoon. He should keep the plan as simple as possible, at the same time ensuring that it effectively supports the commander's intent.

Step 7 - Issue the order

The platoon leader should issue his order to all subordinate leaders and vehicle commanders. Once everyone has arrived at the place and time specified in the warning order, the platoon leader or PSG should ensure that everyone has recorded the applicable graphic control measures. The platoon leader should issue the revised operations overlay before he starts; he should have a copy of the graphics for each of his leaders. The PSG ensures that each subordinate leader's overlay matches the platoon leader's overlay. To use his time most efficiently, the platoon leader should use a walk-through rehearsal as part of his briefing of paragraph 3 of the order.

If he can issue the order from a favorable vantage point, the platoon leader can physically indicate the ground over which his scouts will maneuver. If a vantage point is not available, he can use a terrain cloth, sand table, or map as a reference. The platoon leader should have a briefing kit available to build a model of the area of operations; items in the kit might include the following:

- Nylon rope and nails or spikes.
- Preconstructed Plexiglas squares for units and equipment (blue for friendly elements, red for enemy forces).
- "Micro" armor vehicles or other models.
- Pens and markers.
- Stakes.
- Engineer tape.
- Operational symbol cutouts.
- Dry eraser board.

The platoon leader issues his finalized order in the five-paragraph OPORD format. He refers to notes to make sure he does not forget anything. He ensures that all subordinate leaders understand the entire plan as well as their particular portion of it. To ensure complete understanding of the operation, the platoon leader should end the order with a brief-back of key points by his leaders.

Step 8 - Supervise and refine

Flexibility is the key to effective operations. The platoon leader must be able to refine his plan whenever new information becomes available. If he adjusts the plan, he must inform the platoon and supervise implementation of the changes. Once the operation has begun, the platoon leader must be able to direct his platoon in response to new situations.

Crew orders, rehearsals, and inspections are essential elements of the supervision process as the platoon prepares for the mission. The following paragraphs discuss these procedures in detail.

Crew orders. The platoon leader and PSG make sure all crewmembers have been briefed by their leaders or vehicle commanders and understand the platoon mission and concept of the operation.

Rehearsals. The scout platoon leader should never underestimate the value of rehearsals. They are his most valuable tools in preparing the platoon for the upcoming operation. Refer to [FM 101-5](#) for a detailed discussion of rehearsal types, techniques, and procedures. The platoon leader uses well-planned, efficiently run rehearsals to accomplish the following purposes:

- Reinforce training and increase proficiency in critical tasks.
- Reveal weaknesses or problems in the plan.

- Synchronize the actions of subordinate elements.
- Improve each soldier's understanding of the concept of the operation.

Rehearsal types. The platoon leader can choose among several types of rehearsals, each designed to achieve a specific result and with a specific role in the planning and preparation timeline. The following discussion focuses on the five rehearsal types.

Confirmation brief. The confirmation brief is, in effect, a reverse briefing process routinely performed by subordinate leaders immediately after receiving any instructions, such as an OPOD or FRAGO. They confirm their understanding by repeating and explaining details of the operation for their leader. In the scout platoon, the platoon leader should conduct confirmation briefs after his subordinate leaders have received the OPOD, but before other phases of the platoon rehearsal begin.

Backbrief. Leaders perform this type of rehearsal throughout the planning and preparation timeline to help clarify their intent for their subordinates. The backbrief allows the platoon leader to identify problems in his own concept of the operation and his subordinates' understanding of the concept; he also uses the backbrief to learn how subordinates intend to accomplish their missions.

Combined arms rehearsal. This rehearsal is normally conducted by a maneuver unit headquarters, after subordinate leaders have issued their orders, to ensure that subordinates' plans are synchronized and that their plans will properly achieve the higher intent. The scout platoon takes part in combined arms rehearsals as part of a larger tactical element.

Support rehearsal. Support rehearsals are normally conducted within the framework of a single operating system, such as fire support or CSS, or a limited number of operating systems. The goals are to ensure that support elements can achieve their missions within the higher commander's plan and that their support plans are synchronized with the overall maneuver plan. The rehearsals are conducted throughout the planning and preparation timeline.

Battle drill or SOP rehearsal. This rehearsal, conducted throughout the planning and preparation timeline, is used to ensure that all participants understand a technique or a specific set of procedures. It does not necessarily cover a published drill or SOP, giving the commander or leader flexibility in designing the rehearsal. For example, the scout platoon leader could rehearse procedures for marking obstacle lanes or establishing local security.

Rehearsal techniques. The platoon leader can choose among several techniques in conducting rehearsals, which should follow the crawl-walk-run training methodology to prepare the platoon for increasingly difficult conditions. As noted in [FM 101-5](#), techniques for conducting rehearsals are limited only by the resourcefulness of the commander or leader; that manual outlines six basic techniques (full dress, reduced force, terrain model, sketch map, map, and radio). The following discussion covers these techniques, which are listed in descending order in terms of the preparation time and resources required to conduct them. Considerations in selecting a rehearsal technique include the following:

- **Time.** How much will be needed for planning, preparation, and execution?
- **Multiechelon.** How many echelons will be involved?
- **Operations security (OPSEC).** Will the rehearsal allow the enemy to gain intelligence about upcoming operations?
- **Terrain.** What are the applicable terrain considerations?

Full dress rehearsal. This rehearsal produces the most detailed understanding of the mission, but is the most difficult to conduct in terms of preparation and resources. It involves every soldiers and system participating in the operation. If possible, units should conduct the full dress rehearsal under the same conditions (such as weather, time of day, terrain, and use of live ammunition) that they will encounter during the actual operation. The scout platoon generally will take part in full dress rehearsals as part of a larger unit.

Reduced force rehearsal. This rehearsal normally involves only key leaders of the unit and is thus less extensive than the full dress rehearsal in terms of preparation time and resources. The commander decides the level of leader involvement. The selected leaders then rehearse the plan, if possible on the actual terrain to be used for the actual operation. The reduced force rehearsal is often conducted to prepare leaders for the full dress rehearsal.

Terrain model rehearsal. This is the most popular rehearsal technique, employing an accurately constructed model to help subordinates visualize the battle in accordance with the commander's or leader's intent. When possible, the platoon leader places the terrain model where it overlooks the actual terrain of the area of operations or is within walking distance of such a vantage point. Size of the model can vary, but it should be large enough to depict graphic control measures and important terrain features for reference and orientation. Participants walk or move "micro" armor around the table or model to practice the actions of their own vehicles in relation to other members of the platoon.

Sketch map rehearsal. Units can use the sketch map technique almost anywhere, day or night. Procedures are similar to those for the terrain model rehearsal. The sketch must be large enough to allow all participants to see as each subordinate "walks" through an interactive oral presentation of his actions. Scout platoon elements can use symbols or "micro" armor to represent their locations and maneuver on the sketch.

Map rehearsal. Procedures are similar to those for the sketch map rehearsal except that the commander or leader uses a map and operation overlay of the same scale as he used to plan and control the operation. This technique is useful in conjunction with a confirmation brief or backbrief involving subordinate leaders and vehicle commanders. The platoon leader uses the map and overlay to guide participants as they brief their role in the operation.

Radio rehearsal. The commander or leader conducts this rehearsal by having his unit conduct critical portions of the operation orally and interactively over established communications networks. The radio rehearsal may be especially useful when the situation does not allow the platoon to gather at one location. Subordinate elements check their communications systems and rehearse events that are critical to the platoon plan. To be effective, the radio rehearsal requires all participants to have working communications equipment and a copy of the OPORD and applicable overlays.

Inspections. Precombat inspections (PCI) allow leaders to check the platoon's operational readiness. The key goal is to ensure that soldiers and vehicles are fully prepared to execute the upcoming mission. The platoon leader makes sure the entire chain of command conducts precombat checks (PCC) and PCIs in accordance with [FKSM 17-98-3](#) or his own SOP. The following are examples of procedures that can be covered in PCCs and PCIs:

- Perform before-operation maintenance checks and report or repair deficiencies.
- Perform prepare-to-fire checks for all weapons and report or repair deficiencies. Make sure

weapons are boresighted and all sights are referred. Machine guns should be test-fired, if possible.

- Upload vehicles in accordance with SOP.
- Conduct resupply of rations, water, fuel, oil, all weapons, ammunition, pyrotechnics, first-aid kits, and equipment batteries (for such items as flashlights, night-vision devices, mine detectors, and NBC alarms).
- Make radio checks, when possible.
- Camouflage vehicles to match the area of operations.
- Make sure crewmembers are in the correct uniform and mission-oriented protective posture (MOPP) level.

SECTION 4 — SITUATIONAL AWARENESS

Situational awareness is the ability to maintain a constant, clear mental picture of the tactical situation. This picture includes an understanding of both the friendly and enemy situations and of relevant terrain. It also entails the ability to relate battlefield information and events through space and time to form logical conclusions and make decisions that anticipate events. Since the platoon normally operates dispersed as individual sections or squads, it is essential that all scout leaders maintain situational awareness so they can make sound, quick tactical decisions. A critical outcome of situational awareness on the part of all scouts is a reduction in fratricide incidents.

BATTLEFIELD VISUALIZATION

The commander will structure the battlefield based on the conditions of METT-TC and his commander's intent. How he does this affects the scout platoon leader's mission planning and his ability to maintain situational awareness. The framework of the battlefield can vary from a very rigid extreme with obvious front and rear boundaries and closely tied adjacent units to a dispersed and decentralized structure with few secure areas and unit boundaries and no definable front or rear.

Between these extremes is an unlimited number of possible variations. Maintaining situational awareness becomes more difficult as the battlefield becomes less structured. Modern, highly mobile operations with small forces lend themselves to a less rigid framework that challenges the scout's ability to maintain an accurate picture of the battlefield.

To have a clear picture of the battlefield, the scout must have virtually perfect knowledge of the friendly situation one level higher than his own. This means the cavalry scout platoon leader must know the troop situation and the battalion scout platoon leader must know the battalion situation. It is also important that the platoon leader update the section and squad leaders periodically regarding the higher situation. The platoon leader must have a relatively complete knowledge of the terrain, and he must know as much as possible about the enemy. (**NOTE:** The requirement to maintain a real-time picture of the battlefield one level higher does not relieve the scout of the requirement to understand the situation and commander's intent two levels higher than his own. The difference is that his understanding of the situation two levels higher does not have to be as specific or in real time.)

Most of the information the scout platoon leader needs comes in the form of reports over his FM communication system. He receives many reports based on his platoon's understanding of shared,

common graphics. Effective graphics require that the subordinate elements report periodically as they accomplish requirements. The platoon leader must be aware of when his scouts report so he can maintain a current visualization of the situation. If an element does not report in a timely manner, the platoon leader must quickly determine the situation of the overdue element.

Although many reports are not addressed specifically to him, particularly on the higher net, the scout platoon leader must monitor them by eavesdropping on the nets as traffic is sent. How effectively he can accomplish this is, to some degree, experience-dependent; however, there are techniques he can apply to relate the information he is receiving to his map and thereby track the tactical situation.

The scout platoon leader's map is the key to maintaining situational awareness. He should plot all friendly position reports up to one level higher than his own. Information from spot reports should also be plotted. The scout should use different colors for friendly and enemy elements to allow quick recognition. To avoid cluttering the map, he should place a dot or symbol on his map where the element is located and label the point with a number. The same number should then be written in the map margin (or beyond the area of operations) with the complete spot report or unit ID next to it. This notation should also include the time of the report. As positions or reports are updated, the old symbol is crossed off and a new one with a corresponding notation is added; it is critical that updates to previous reports be clearly identified as such during transmission.

This simple system allows all scouts to easily track and monitor the tactical situation. It can be augmented by a formal platoon log, kept on the platoon leader's or PSG's vehicle or on both.

BATTLE SPACE

As discussed previously, an accurate picture of the battlefield provides the platoon leader with important tactical information, including friendly and enemy positions and relevant terrain. In turn, complete understanding of the military significance of this picture requires knowledge of the concept of battle space, the key element in the intellectual process of visualizing the battlefield.

At the most fundamental level, battle space is the three-dimensional "bubble" or area in which the platoon can acquire enemy forces and influence them with effective fires. This space is defined by numerous battlefield factors: the locations of friendly forces, including the platoon's individual scout sections, squads, OPs, and patrols; the effects of terrain, weather, and movement; and the ranges of all available platoon weapons and sensing systems. Each scout section or squad has its own battle space; the platoon battle space is the sum of individual section/squad battle spaces (see [Figure 2-9](#)). Platoon battle space is not restricted by boundaries; it can overlap with the battle space of adjacent units.

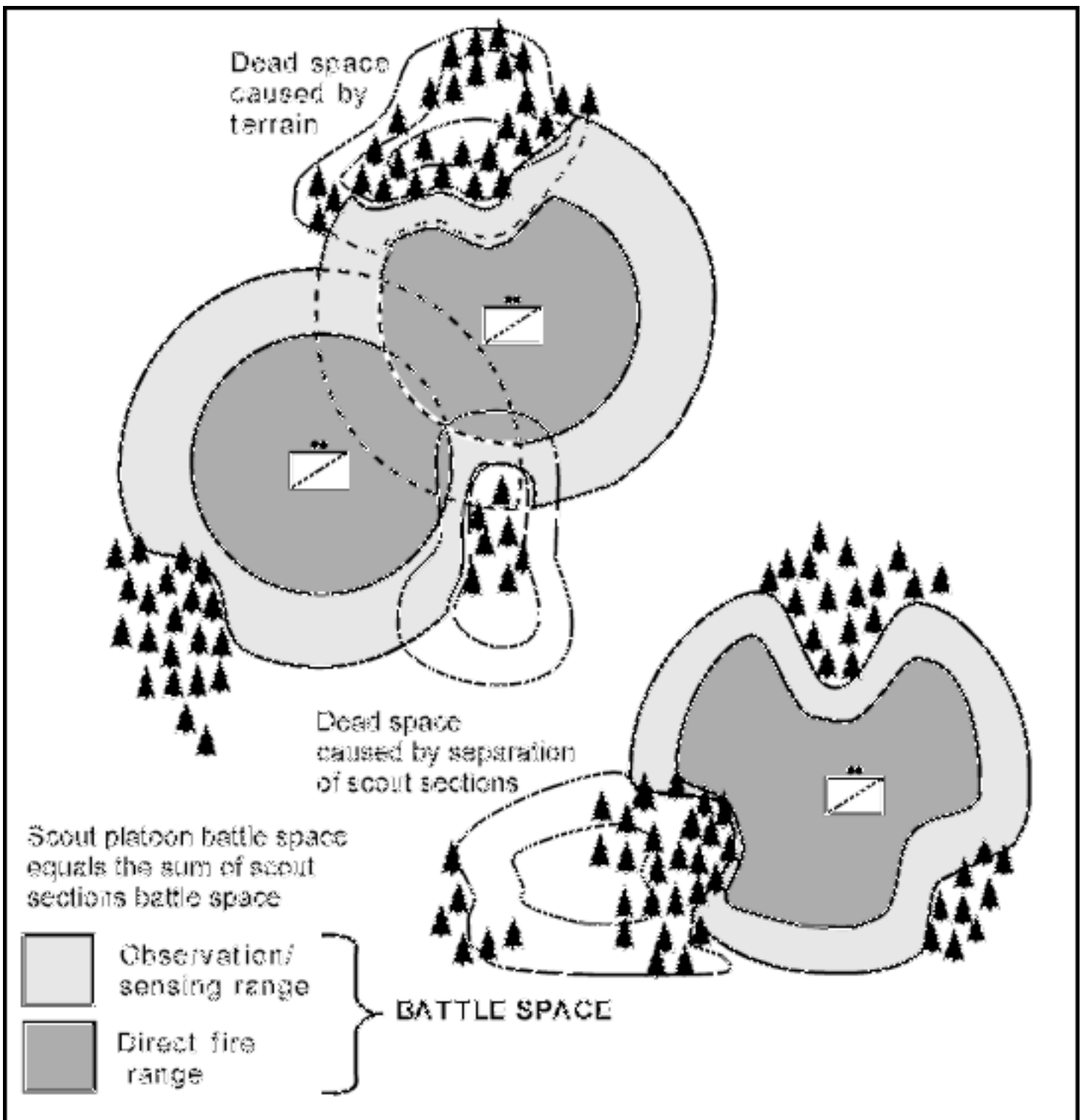

Figure 2-9. Scout platoon's battle space.

Battle space has applications in all phases of mission planning and execution. During the planning process, it is a critical factor in selection of routes and tentative positions. Once mission execution begins, the platoon leader's knowledge of his battle space is critical when he must issue timely and effective orders as the situation changes.

The importance of battle space demands that the platoon leader direct most of his battle command effort toward managing, and enhancing, his space. He must be aware at every moment how battle space is changing as friendly and enemy forces move and as terrain and visibility conditions change (see [Figures](#)

[2-10A](#) and [2-10B](#)). He must evaluate how these changes affect his scout sections and squads.

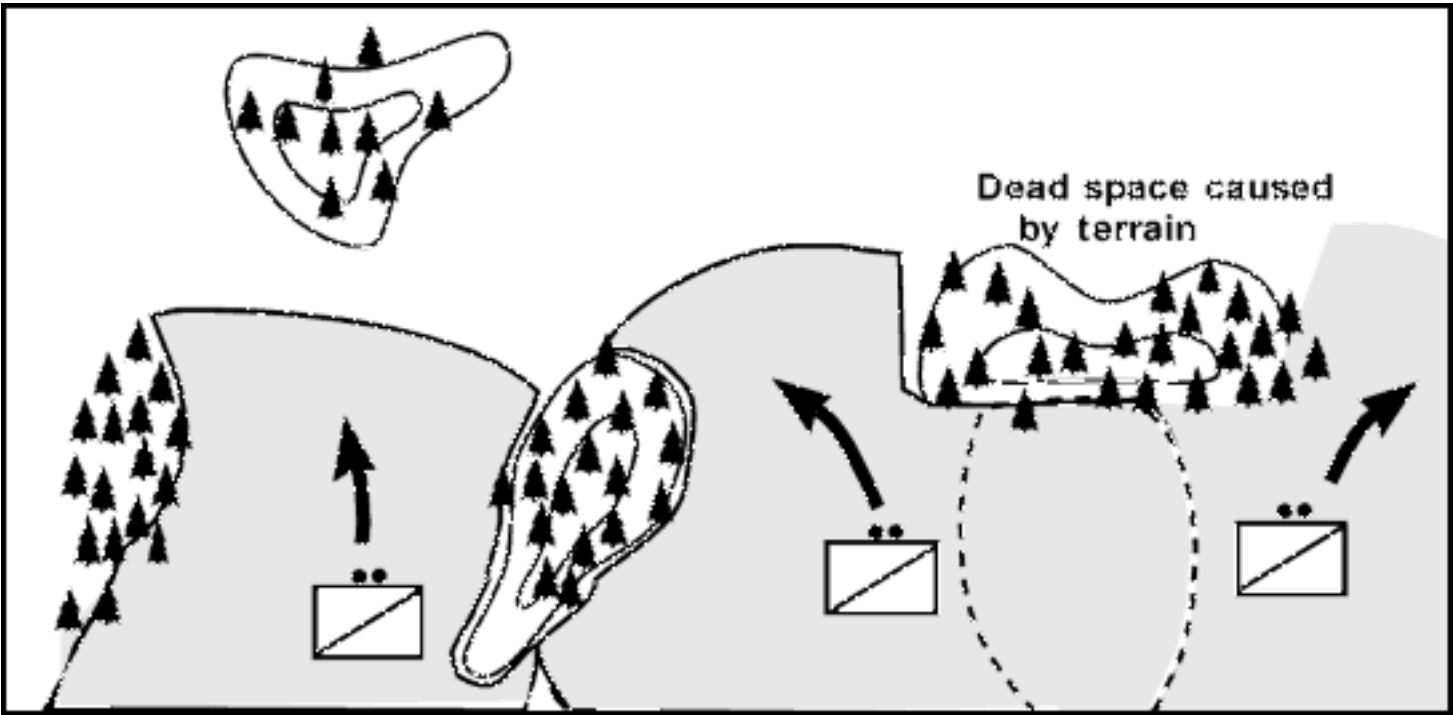

Figure 2-10A. Effects of movement on battle space.

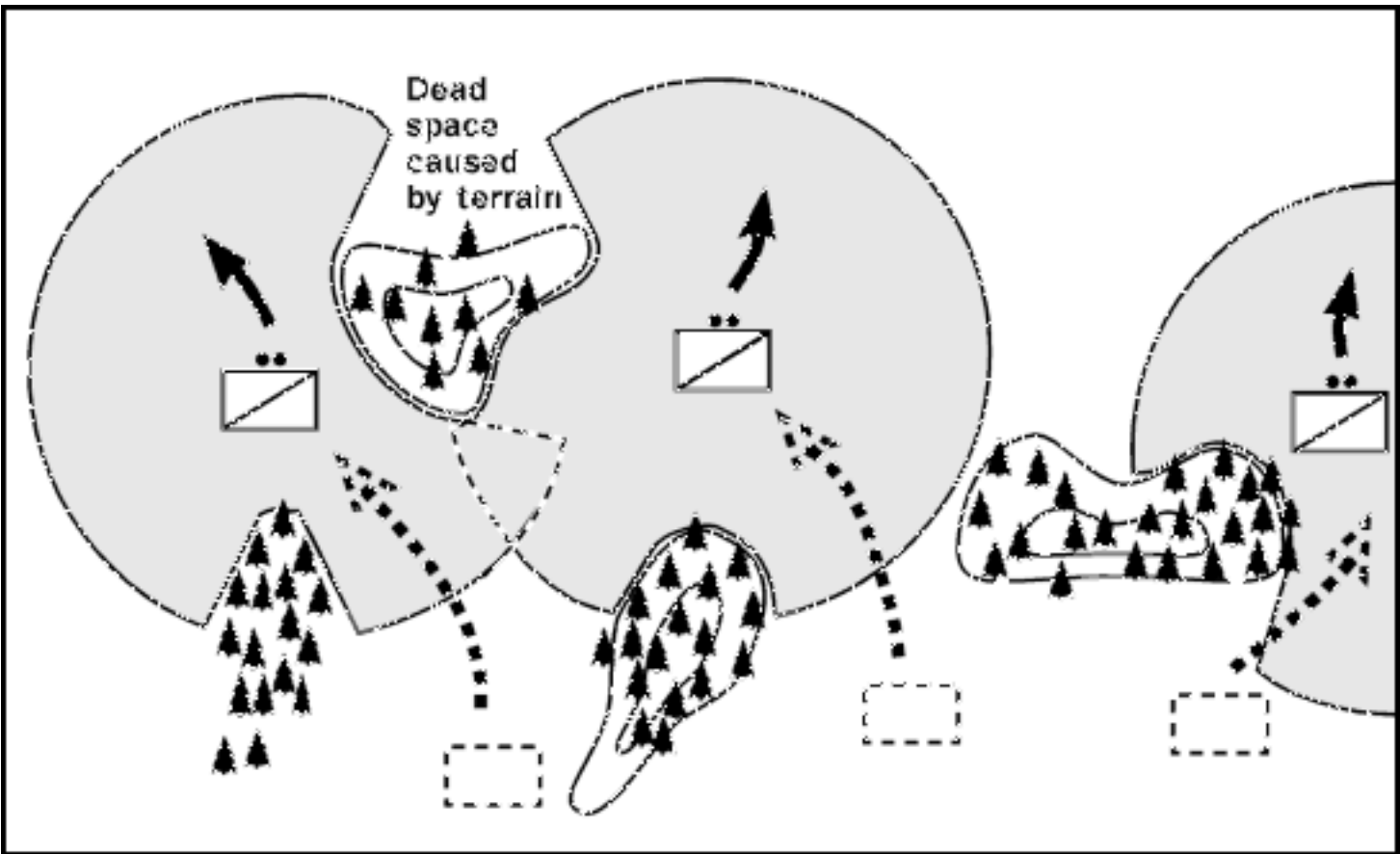

Figure 2-10B. Effects of movement on battle space (continued).

As the operation progresses, the platoon leader must take active measures to shape the platoon's battle space to his best advantage. In many situations, he should attempt to eliminate any gaps, or dead space,

that exist within the "bubble." The platoon leader can accomplish this in several ways, such as maneuvering scout sections or squads, repositioning OPs, and deploying patrols or remote sensors. He must also ensure that organic and attached assets are positioned to achieve overlapping coverage of critical points within the platoon's battle space.

The purpose of overlapping coverage is to prevent the enemy from overcoming the friendly reconnaissance effort by degrading or destroying a single platform or sensor. It also prevents the enemy from gaining an advantage during periods when environmental or weather conditions, including limited visibility, degrade the platoon's observation capability or sensor performance.

Refer to [Figures 2-11A](#) and [2-11B](#) for an illustration of how the platoon leader can optimize his battle space.

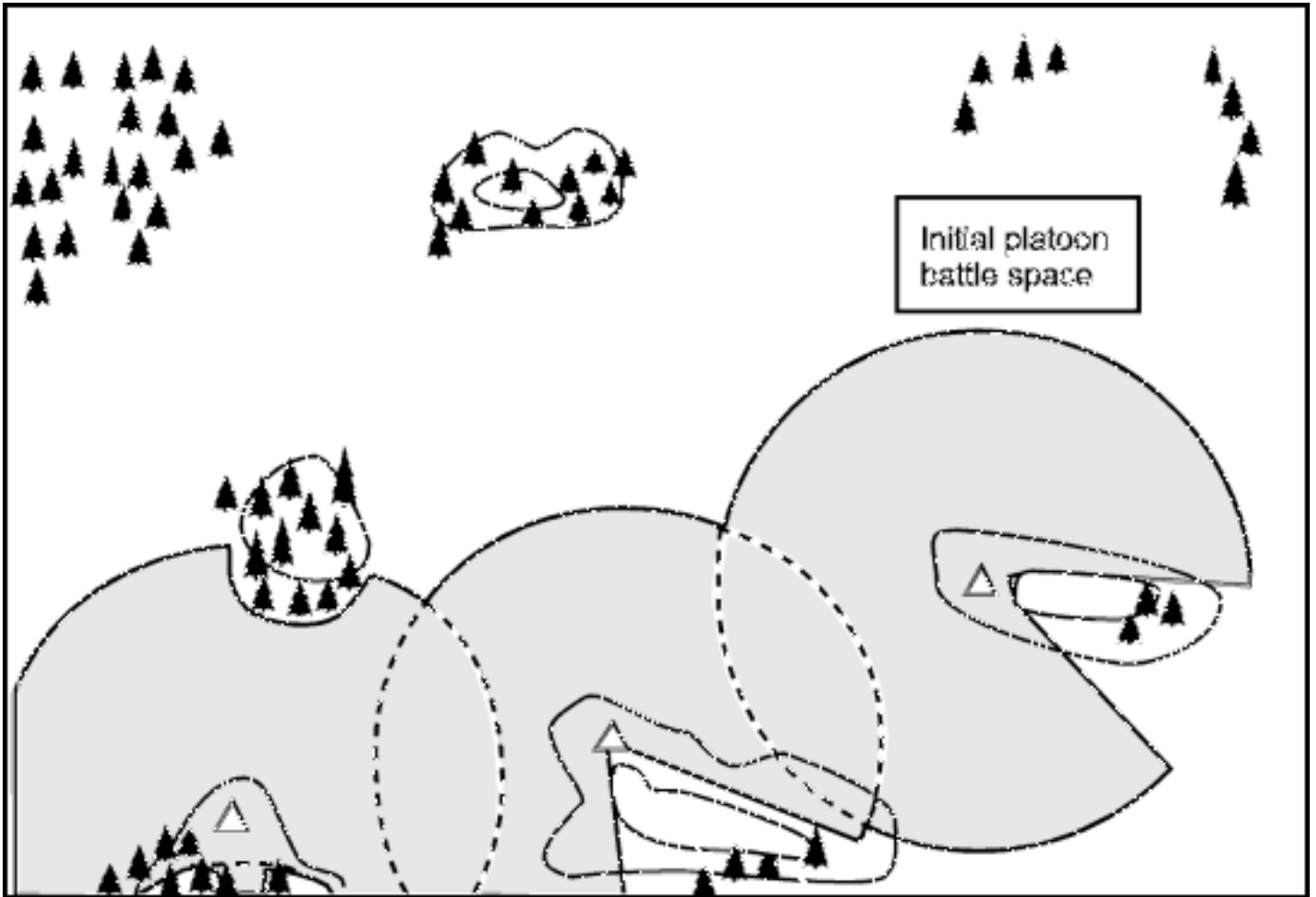

Figure 2-11A. Optimizing battle space.

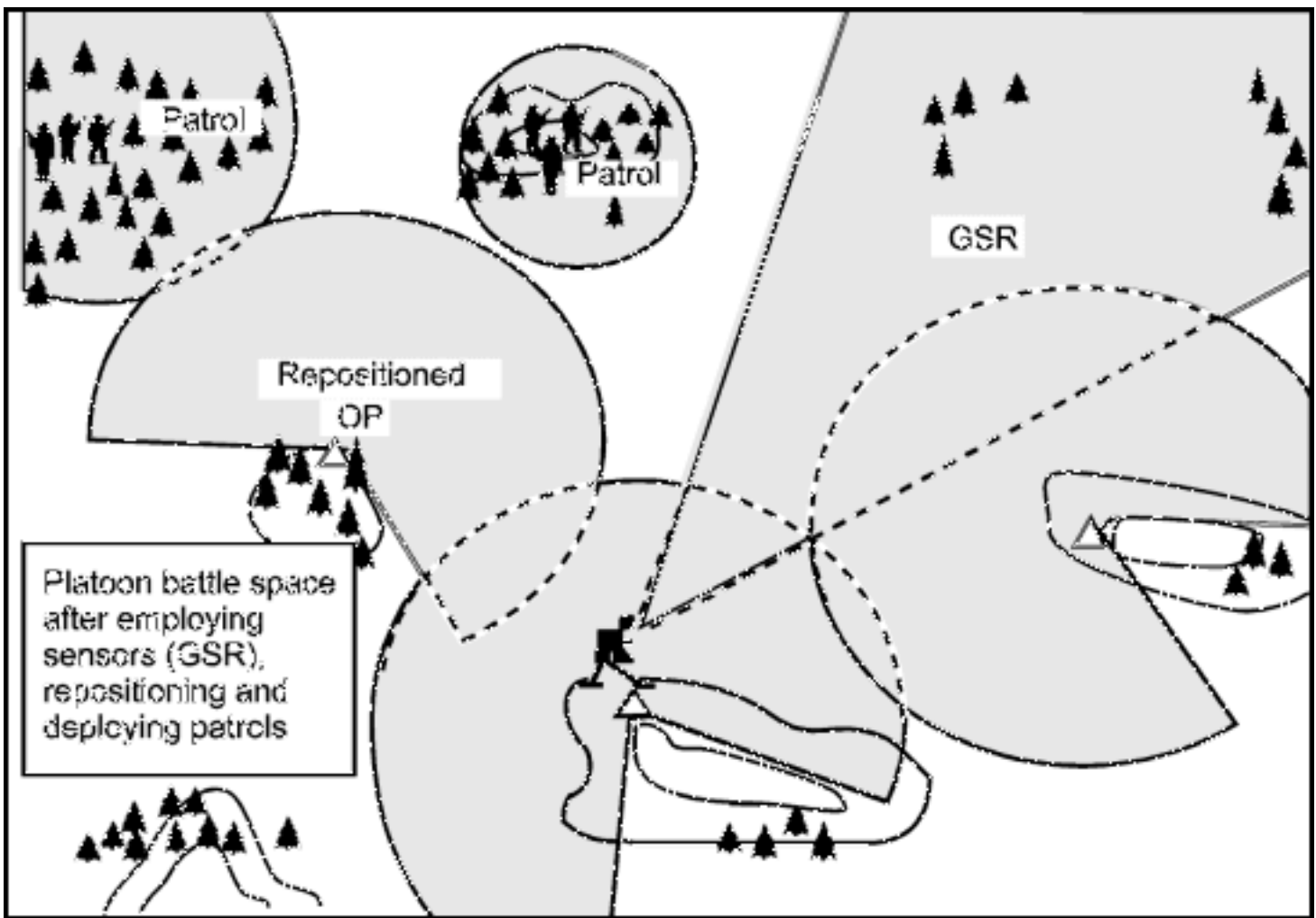

Figure 2-11B. Optimizing battle space (continued).

FRATRICIDE

Recent experience has shown that fratricide is a significant danger to all forces operating on a mobile battlefield where weapon system lethality is significantly greater than identification friend or foe (IFF) capability. Fratricide is the result of many factors, including inadequate direct fire control plans, navigation errors, combat identification failures, and incorrect or inadequate operational graphics. Refer to Appendix F of this manual for an in-depth discussion of fratricide and its prevention.

SPECIAL NOTE: In many situations, the primary cause of fratricide is the lack of positive target identification. To prevent fratricide incidents, commanders and leaders at all levels must ensure positive target identification before they issue commands to fire. In addition, all units must accurately report their locations during combat operations, and all tactical operations centers (TOC) and command posts (CP) must carefully track the location of all subordinate elements in relation to all friendly forces.

SECTION 5 — NAVIGATION

MAPS AND OVERLAYS

The most important role of maps and their accompanying overlays is in helping the platoon to understand and visualize the scheme of maneuver. They are the primary tool the platoon leader uses to organize information concerning the battlefield and to synchronize his assets once the battle begins. They also provide vehicle commanders with a visual reference they can consult as needed. The platoon leader must ensure that each vehicle commander has an updated map with the latest graphic control measures posted on the overlay.

Overlays can be prepared either in traditional fashion or digitally. The platoon leader may receive one or more types of overlays from the battalion or squadron, covering such areas as maneuver, enemy forces, obstacles, fire support, and CSS. All of the information is important; the key for the platoon leader is to combine, augment, and declutter the overlays so the information needed for a specific situation is readily available to the platoon on one simple, combined overlay.

LAND NAVIGATION

To protect his platoon, the platoon leader must learn to use terrain to his advantage. Land navigation of scout vehicles requires him to master the technique of terrain association. This entails the ability to identify terrain features on the ground by the contour intervals depicted on the map. The platoon leader analyzes the terrain using the factors of OCOKA and identifies major terrain features, contour changes, and man-made structures along his axis of advance. As the platoon advances, he uses these features to orient the platoon and to associate ground positions with map locations.

The intellectual concept of battle space is vital to the platoon's survival during navigation and movement. The platoon leader must constantly be aware of key terrain and enemy fields of observation and fire that may create danger areas as the platoon advances. This allows him to modify movement techniques, formations, and routes and to maintain cross-talk with overwatch elements to ensure the platoon is not surprised by the enemy. (**NOTE:** Refer to the discussion of danger areas in [Chapter 8](#) of this manual.)

Navigation under limited visibility conditions is especially challenging. Vehicle thermal sights and night vision goggles provide assistance, but leaders nonetheless can easily confuse terrain features and become disoriented. The platoon can employ a variety of techniques and equipment to assist in navigation. These are summarized in the following paragraphs.

Compass and odometer. This method of navigation entails use of a dismounted compass and the vehicle's odometer. Follow these steps:

- Divide the route or operation into legs or parts, each with a unique direction and distance and a checkpoint at both ends.
- Measure the map distance of each leg or part.
- Determine the magnetic azimuth of each leg or part.
- Develop a chart listing the legs or parts, azimuths, and distances. Write a description of each leg or part. Refer to [Figure 2-12](#) for an example.
- For each leg or part, move the gun tube to the direction of the magnetic azimuth. Maintain turret stabilization at all times; do not traverse the turret except at the start of the next leg or part.

(NOTE: Use of this technique places the vehicle crew and the unit at a distinct disadvantage. It reduces the crew's capability to effectively scan the surrounding terrain and, in turn, can seriously degrade crew and unit security and situational awareness.)

- Use the odometer to measure the distance traveled for each leg or part.
- Review the written description of the route to help prevent navigational errors.

LEG/PART	AZIMUTH	DISTANCE	DESCRIPTION OF ROUTE TRAVELED
AA BLUE to SP	180°	2.5 km	From AA BLUE, travel downhill to the SP, a three-way, hardtop intersection.
SP to RP	90°	5.5 km	At the SP, turn east and travel on a flat hardtop road for about 4 km. The road becomes uphill as you approach the four-way intersection (RP). A downhill grade on the azimuth will mean the RP has been passed.
RP to PP1	183°	6.3 km	At the RP, turn south and travel downhill for 6.3 km, linking up with the XO at PP1. The PP is at the foot of a bridge within sight of two houses.
PP1 to 12	92°	7.4 km	At PP1, turn east, cross the bridge, and travel a flat, cross-country stretch for 7.4 km until you reach three houses (12). Reaching an uphill grade or a hardtop road along the same azimuth will mean 12 has been passed.
12 to 5	60°	5.5 km	From 12, travel along on a 60° azimuth uphill for about 5.5 km, crossing a dirt road and a hardtop road. At hill (5), tanks will be oriented on a 90° azimuth.

Figure 2-12. Route chart for compass and odometer navigation method.

Fires. Using artillery or mortars to fire smoke (during the day) or ground-burst illumination (day or night) can provide a useful check on estimated locations or preplanned targets.

Global positioning systems. Global positioning systems (GPS) receive signals from satellites or land-based transmitters. They calculate and display the position of the user in military grid coordinates as well as in degrees of latitude and longitude.

Most GPS navigation readings are based on waypoints, the known positions entered into the system's memory. The platoon leader identifies points along the route or at the destination and designates them as waypoints. Once waypoints are entered in the GPS, the device can display information such as distance and direction from point to point.

NOTE: In using the GPS, the platoon leader must remember that waypoints are only one of several navigational tools he can use. He must still be prepared to use terrain association and map-reading skills in case satellite or land signals are inoperative or unavailable or his digital systems fail. In addition, the platoon leader must not disregard the effects of terrain on the direction of movement. Terrain features that do not show up on the digital display (such as hills, valleys, and cliffs) may cause deviations in the route the platoon must take to reach the next waypoint.

Shift from a known point. Shifting from a known point is a convenient tool for the platoon leader to use as he maneuvers the platoon and disseminates control measures. The known point is usually a previously distributed graphic control measure, such as a checkpoint or a TRP. Referencing a location from a known point is done in kilometers. For example, 500 meters is given as "POINT FIVE," 1,000 meters as "ONE," and 3,500 meters as "THREE POINT FIVE." Cardinal directions are used. Shifts to the east or west are given first, followed by shifts to the north or south.

As an example, consider the following transmission: "RED SET FROM CHECKPOINT SEVEN – EAST ONE POINT EIGHT – NORTH ONE POINT SEVEN." This means, "We (the Red element) are set at a position 1,800 meters east and 1,700 meters north from checkpoint 7." [Figure 2-13](#) illustrates this example.

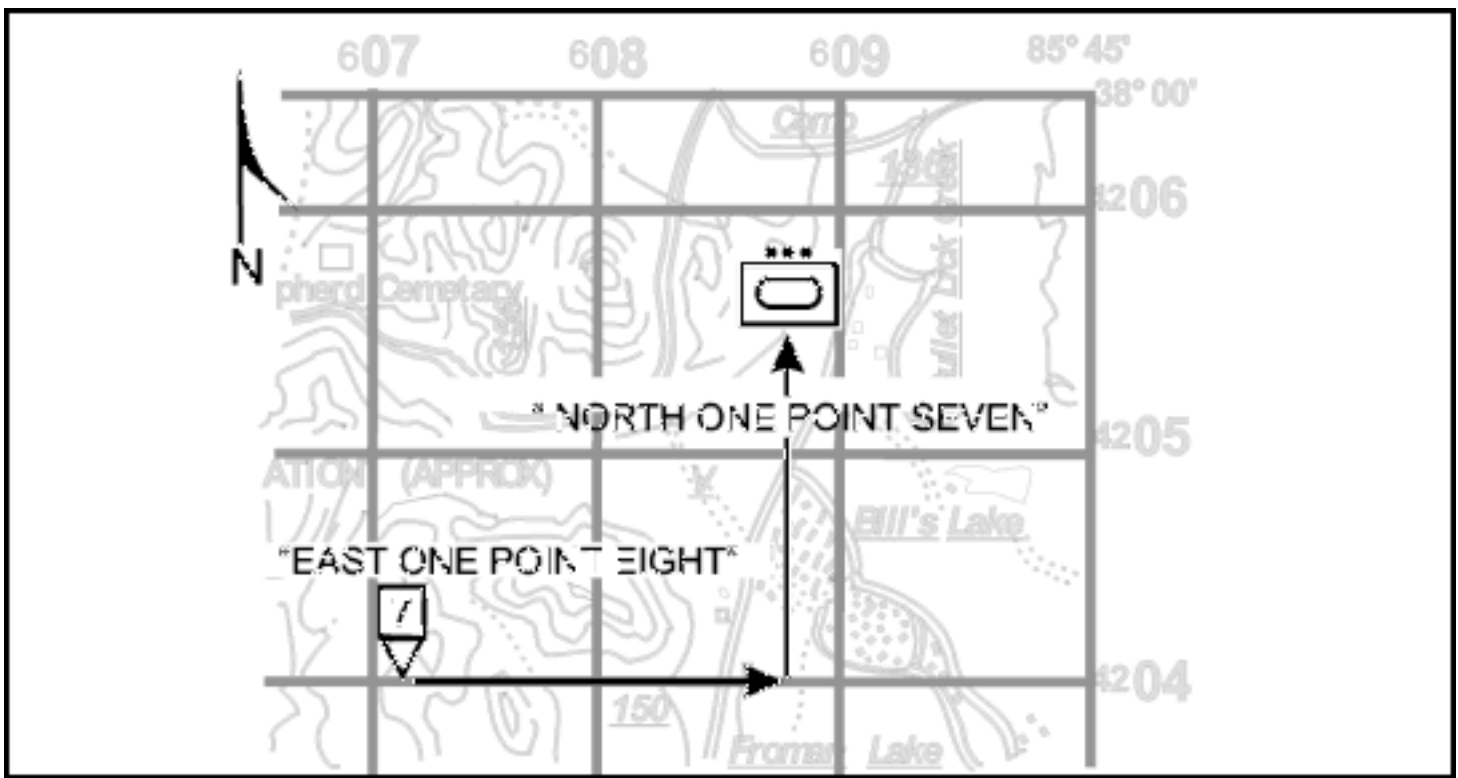

Figure 2-13. Example of shifting from a known point.

Shifts from known points are used routinely to control combat operations. They make reporting of current platoon and enemy positions easier. As noted, the platoon leader can report his location by referencing a graphic control measure. The enemy, however, will quickly figure out the known points if they are continually used in the clear on a nonsecure net. The platoon leader should avoid using the same point more than twice. Instead, he should use a different known point to reference the same location.

NOTE: Many units routinely use the TIRS or grid index reference system (GIRS) to make shifts from a known point. TIRS identifies locations based on terrain points previously designated on an overlay; GIRS uses intersections of four grid squares as the known points.

SECTION 6 — COMMUNICATIONS

Because of the extended frontages and distances over which the scout platoon operates, it must rely heavily on effective communications techniques. These techniques include not only the means of communications (such as wire, visual signals, or radio) and the proper way of using them, but also the correct application of operational terms and effective radiotelephone procedures (RTP). The platoon leader must ensure that all of his soldiers understand communications procedures and the different nets on which the platoon operates.

MEANS OF TACTICAL COMMUNICATIONS

The scout platoon always has several available means of communications. Whether it is using messenger, wire, visual, sound, or radio signals, the platoon must remain flexible enough to react quickly to new situations. Use of each of these means of communication must be carefully planned to avoid dependence

on a single method.

SOPs can help the platoon tremendously in its mission accomplishment. Hand-and-arm and flag signals aid in platoon movement. Clear and concise radio transmissions can reduce transmission times.

Messenger

This is the most secure means of communications available to the scout platoon. Messenger service is generally very flexible and reliable. In an assembly area, it is the preferred means. On an infrequent basis, members of the platoon may be called on to act as messengers to the parent unit's higher headquarters.

Wire

This method of communications is especially effective in static positions or during the conduct of a screening mission. It is very versatile and can be used in many different situations. Using one of the many wire devices available, the scout platoon establishes hot loops to communicate within the platoon, with OPs, and with the parent unit command post (CP) in assembly areas.

Visual

Visual communications are used to transmit prearranged messages quickly over short distances. Scout sections or squads may rely heavily on this type of communications. Since the scout platoon rarely operates as a unit over short distances, however, visual signals are seldom used at the platoon level. In those cases when the entire platoon is together, such as in a coil, in an assembly area, or on a road march, all vehicle commanders must stay alert so they can receive visual signals from the platoon leader and pass them on to other vehicle commanders in the platoon.

Whenever visual signals are used, they must be clear enough to be understood by vehicle commanders as they operate in tactical situations. Standard hand-and-arm or flag signals work well during periods of good visibility. Flashlights, chemical lights, or other types of lights are required during periods of limited visibility. The platoon must exercise extreme care when using lights to avoid alerting the enemy to friendly intentions.

Pyrotechnic ammunition can also be used for visual signaling. The meanings of these signals are identified in paragraph 5 of the OPOD and in the unit signal operation instructions (SOI). The main advantage of pyrotechnics is the speed with which signals can be transmitted. Key disadvantages are the enemy's ability to see them and, potentially, to imitate them.

Sound

This form of communications is used mainly to attract attention, transmit prearranged messages, and spread alarms. Sound signals carry only short distances; in addition, range and clarity are greatly reduced by battle noise. Since they are open to enemy interception, use of sound signals may be restricted for security reasons. Prearranged meanings for sound signals are outlined in the unit SOP and SOI; they must be kept simple to prevent misunderstandings.

Radio

The radio is the platoon's most flexible, most frequently used, and least secure means of

communications. The most effective way to use the radio is to follow standard guidelines for effective RTP; these include brevity, proper use of authentication tables, and the use of approved operational terms. Radio signals can be traced by enemy direction-finding units. Once found, the transmitter can easily be destroyed. For this reason, the scout platoon leader must strictly enforce radio discipline regardless of encryption devices; survival of the platoon depends on good radio habits.

RADIO NET ORGANIZATION AND RESPONSIBILITIES

Battalion scout platoon nets

The following are the radio nets employed and/or monitored by leaders in the battalion scout platoon. (See [Figure 2-14.](#))

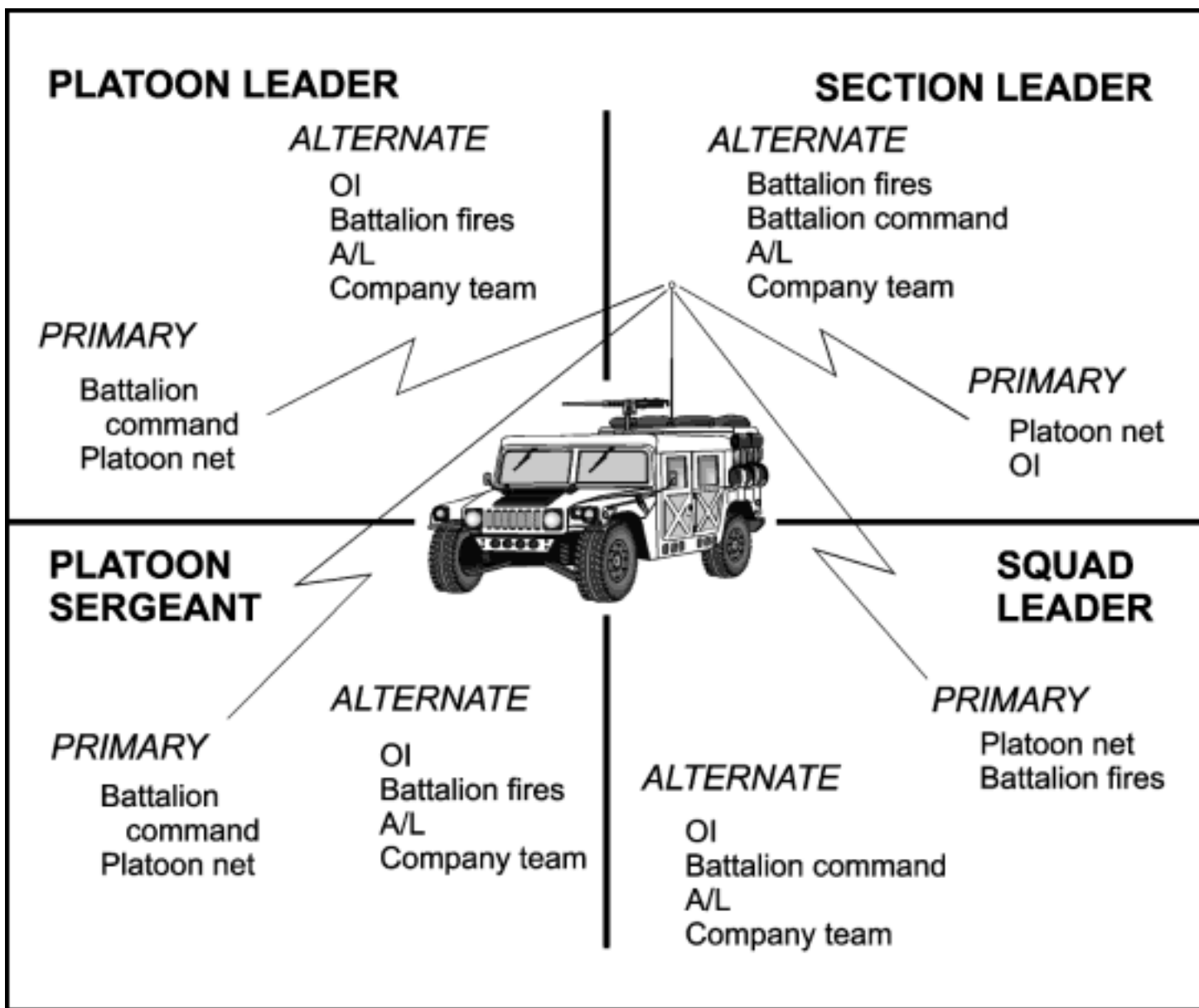

Figure 2-14. Battalion scout platoon nets.

Platoon. This net is used to conduct all platoon operations. All elements within the scout platoon must have the ability to monitor and transmit on this net at all times. Making sure this happens is one of the

keys to effective command and control during the conduct of tactical operations.

Battalion command. The battalion command net is the primary net used to direct the tactical operations of the battalion. It is monitored continuously by all subordinate commanders in the battalion, as well as by key staff members and the TOC. As a key maneuver element of the battalion, the scout platoon must monitor this net continuously. The platoon leader and the PSG should both have the capability to monitor and transmit on this net when the battalion is conducting tactical operations.

Operations and intelligence. Many battalions operate an OI net to handle R&S reports and thus make the command net more efficient. This net can also be used to control the R&S effort before the battalion main body begins tactical operations. If the battalion has not begun tactical operations but the scouts are engaged in reconnaissance or surveillance operations, the scout platoon may use this as its primary net. In such a case, both the scout platoon leader and PSG should be able to monitor and receive on this net.

The scout platoon should continue to maximize the use of the OI net to pass information while conducting reconnaissance in support of the main body, even after the main body has begun its operations. The platoon leader can monitor the command net at this time or choose to remain on the OI net. If he continues to use the OI net, he should designate a member of the platoon to eavesdrop on the command net to alert him when the battalion commander needs to communicate directly with the scouts or when critical traffic is being passed over the command net.

Battalion fires. Because rapidly coordinating for and adjusting indirect fires is vital in all R&S operations, the fires net is extremely critical to the success of scout platoon operations. The platoon should have all radios that are not on the higher command net or the platoon net preset to this net. All scouts, whether operating mounted or dismounted and regardless of how many radios they have, must have the ability to quickly change to this net and coordinate indirect fire. The scout platoon leader must coordinate with the battalion FSO regarding the use of the fires net to ensure that the platoon can use it to send voice call for fire messages.

Company team. All scouts must have the ability to rapidly change to any of the battalion company team nets. These nets are used to conduct coordination for handing off enemy targets once the scouts make contact.

Administrative/logistics. The scout PSG will usually monitor the A/L net for the platoon, but the platoon leader must be familiar with it as well. The PSG uses it as required to send routine A/L reports. This net is also used to coordinate resupply operations and evacuation of casualties.

Retrans. When the scout platoon operates at extended distances from the battalion TOC, it may use the battalion retrans net to facilitate effective communications between the scout platoon leader and the TOC. The platoon leader should request use of the retrans net during all missions requiring FM communications at extended ranges.

Cavalry scout platoon nets

The following are the radio nets employed and/or monitored by leaders in the cavalry scout platoon. (See [Figure 2-15](#).)

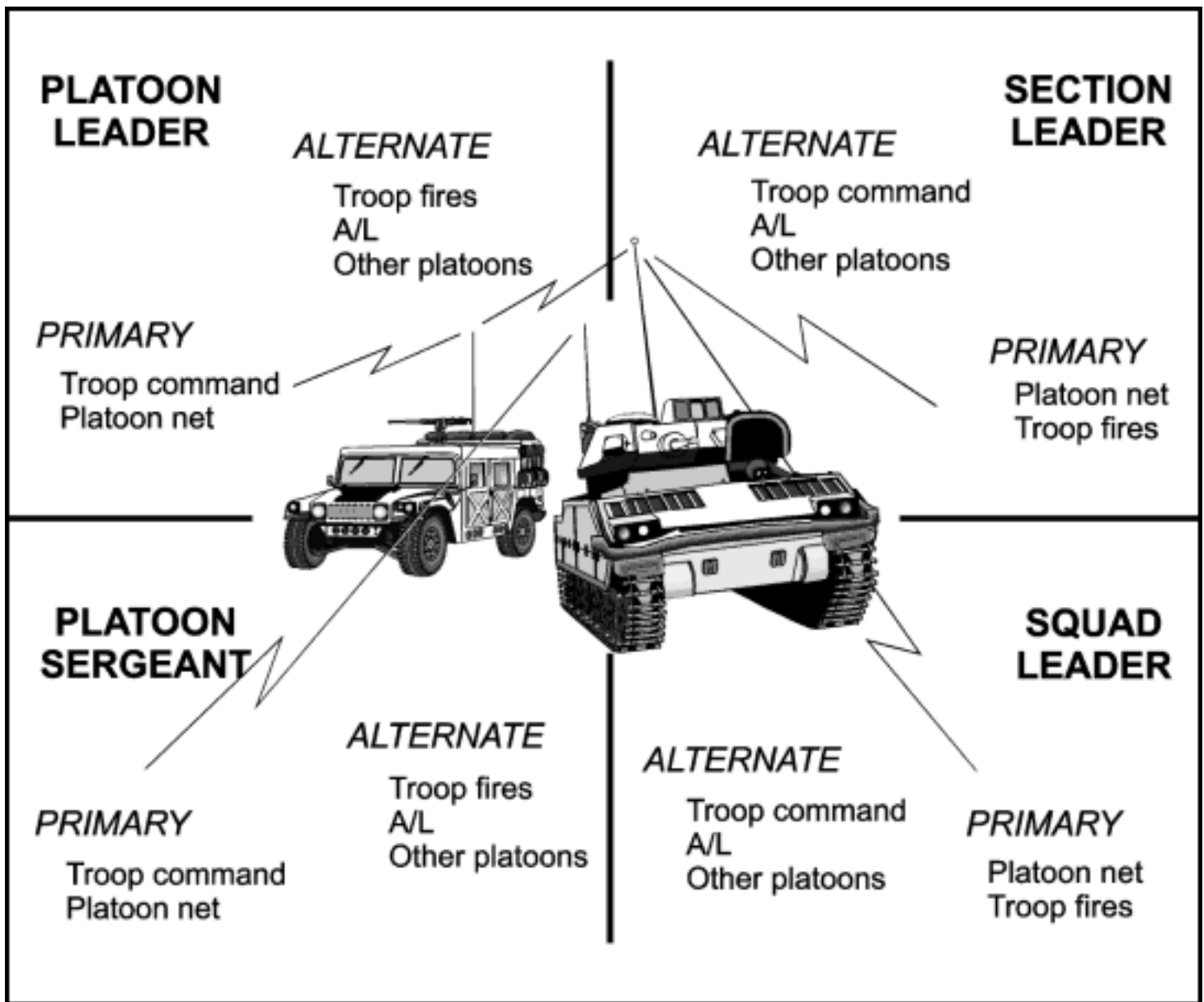

Figure 2-15. Cavalry scout platoon nets.

Platoon. This net is used to conduct all platoon operations. All elements within the scout platoon must have the ability to monitor and transmit on this net at all times. Making sure this happens is one of the keys to effective command and control during the conduct of tactical operations. All scouts must also have the ability to rapidly change to any other platoon net as required to coordinate contact points or handover of enemy targets.

Troop command. This net is used to maneuver the cavalry troop as well as to process most routine reports. The troop TOC is the net control station (NCS), and the scout platoon leader or PSG sends routine reports to the troop XO. This net can be used by scout and tank platoon leaders to talk to each other and coordinate key tactical actions of their platoons; however, platoon leaders will use each other's platoon nets to pass routine messages not of interest to the commander.

Both the scout platoon leader and PSG must always have the ability to monitor and transmit on this net. All scouts must be able to move to this net to send reports and receive guidance if they are unable to contact their platoon leader or PSG.

Troop fires. Many troops operate a troop fires net. It is used to send calls for fire to the troop FSO or directly to the troop mortars. The scout platoon leader should direct all radios not actively operating on another net to enter this net. All scouts must have the ability to change to this net and coordinate indirect fire.

Administrative/logistics. The PSG will usually monitor the A/L net for the platoon, but the platoon leader must be familiar with it as well. The PSG uses it as required to send routine A/L reports. This net is also used to coordinate resupply operations and evacuation of casualties.

NET CONTROL

The scout platoon net is the key to command and control of the platoon. The smooth functioning of this net allows accurate information to be passed quickly both to and from the platoon leader. This information flow is critical in maintaining the platoon leader's situational awareness and in enhancing command and control. When contact is made, the volume of traffic on the scout platoon net will increase drastically. The platoon must be organized to control, understand, and process this vast amount of information while engaging the enemy and possibly being engaged in turn. The following guidelines will help to ensure that the information flowing over the net is organized and controlled in a way that permits the platoon leader to both understand it and issue orders in response to it.

Flash traffic

The platoon leader should, in either the platoon order or the unit SOP, establish criteria for flash traffic. For example, the flash traffic criteria could dictate special handling of the platoon's prescribed PIR. When a scout gains information relevant to a critical PIR item, he interrupts any net traffic with a proword such as "FLASH--FLASH--FLASH." The use of such a proword immediately advises all other scouts to get off the net, thus clearing it for the critical traffic to be passed.

Net discipline

The PSG is responsible for net discipline. In this capacity, he will challenge any violation of procedure as it occurs. Improper or inefficient radio procedures, even in routine administrative reports, inhibit effective command and control.

Effective messages

The best way to ensure effectiveness of a radio message is to write it out before it is sent. This procedure yields greater accuracy and ultimately is more timely. It also ensures that the message is sent correctly, completely, and clearly in the shortest possible amount of time. The message is easier to understand, and the duration of the electronic signature of the sending station is minimized.

Radiotelephone procedures

Proper RTPs are the cornerstone of effective command and control in the scout platoon. All scouts must be expert in communications procedures. This not only ensures efficient communications within the platoon, but also allows all members of the platoon to communicate effectively with outside elements such as the battalion, squadron, troop, company, other platoons, and subordinate and/or supporting elements.

TECHNIQUES OF EFFECTIVE COMMUNICATIONS

The platoon leader and PSG are responsible for ensuring that their scouts understand and adhere to the following guidelines, which can contribute to more effective, more secure tactical communications.

Know the system

Each scout must be an expert at using and maintaining his FM communications system. In particular, he must understand its capabilities and limitations. He must also understand how to maintain the system and how to troubleshoot it whenever he suspects it is not functioning properly.

Minimize duration

All messages sent within or from the scout platoon must be short and informative. The longer the message, the greater the opportunity of enemy elements to electronically determine the scout's location. Message length can be controlled in several ways:

- Write the message down and then eliminate all unnecessary words from the written message before sending it.
- Read the message as written when sending it.
- Use a brevity code that reduces the need to explain the tactical picture in detail.
- Break long messages into several parts and send each separately.

Minimize signature

When sending a message, every scout must be conscious of the size and nature of the electronic signature that he is emitting. He must consider the following methods for reducing the size of the signature:

- Use terrain to mask the signature from the direction of the enemy.
- Set the transmitter power to low if that setting will provide sufficient range (as it often does within the scout platoon, section, or squad).
- Whenever possible (particularly in stationary operations), use an expedient directional antenna to restrict the enemy's ability to monitor the signal. See [Chapter 9](#) of this manual for instructions on how to construct and use such an antenna.

Use an effective format

A thorough knowledge of report formats is critical in ensuring timely reporting of enemy information, especially in fast-moving tactical situations. Every scout should be familiar with the report formats that are outlined in [FKSM 17-98-3](#) and know how to use them effectively. At the same time, however, they must never delay reports only to assure the correct format; **ALWAYS REPORT ACCURATE INFORMATION AS QUICKLY AS POSSIBLE!**

As a basic guideline, reports of enemy activity should follow the SALUTE format, which covers these factors:

- **Size.** This includes the number of sighted personnel, vehicles, or other equipment.
- **Activity.** This covers what the enemy is doing.
- **Location.** This is usually reported as the grid coordinates of enemy elements.

- **Unit.** This covers any indications useful in unit identification, such as patches, signs, and vehicle markings.
- **Time.** This item details when enemy activity was observed.
- **Equipment.** This includes description or identification of all equipment associated with the enemy activity.

CHAPTER 3

Reconnaissance

Scout platoons conduct reconnaissance to provide their commander with information that has tactical value concerning the terrain, the enemy, and the effects of weather within an area of operations. Scouts reconnoiter terrain to determine movement and maneuver conditions. When they find the enemy, they determine his disposition, strengths, and weaknesses in detail. The scout platoon provides the information necessary to allow combined arms forces to maneuver against the enemy, strike him where he is most vulnerable, and apply overwhelming power to defeat him.

Reconnaissance is conducted as part of all scout missions and is performed both mounted and dismounted. Scouts conduct dismounted reconnaissance to gather detailed information, to enhance security, and to move with stealth or in rugged terrain. Scouts conduct mounted reconnaissance when time is critical and they need to cover a large area quickly. Mounted reconnaissance allows them to maintain the fast tempo of combat operations and to make maximum use of the optics, firepower, communications, and protection provided by their scout vehicle.

Scouts must thoroughly understand how the enemy deploys his reconnaissance and security forces, as well as the sequence and timing of their entry into battle. The scouts' accurate and timely reporting of enemy locations and strength can make the difference between winning or losing the main battle. At the same time, it is critical that scouts never lose sight of their reconnaissance priorities and become involved in battles that invariably wear down reconnaissance forces.

CONTENTS

<u>Section 1</u>	<u>Purpose and Fundamentals</u>
<u>Section 2</u>	<u>Reconnaissance Methods</u>
<u>Section 3</u>	<u>Route Reconnaissance</u>
<u>Section 4</u>	<u>Zone Reconnaissance</u>
<u>Section 5</u>	<u>Area Reconnaissance</u>
<u>Section 6</u>	<u>Obstacle/Restriction Reconnaissance</u>
<u>Section 7</u>	<u>Infiltration and Exfiltration</u>

SECTION 1 — PUPOSE AND FUNDAMENTALS

PURPOSE

Based on their commander's intent and guidance, scouts conduct reconnaissance forward of other friendly forces to provide current, accurate information about the enemy, terrain, weather, and physical resources within a specified area of operations. This provides the follow-on forces with an opportunity to maneuver freely and rapidly to their objective. Scouts keep the follow-on forces from being surprised or interrupted, and they prevent these forces from losing men and equipment along the way to the objective. Scout platoons perform three types of reconnaissance: route, zone, and area.

FUNDAMENTALS

Six fundamentals are common to all successful reconnaissance operations. Scout leaders must ensure that their plans adhere to these fundamentals, which are covered in the following discussion, during the execution of reconnaissance missions.

Maintain tempo and focus

As the scout platoon leader plans and executes the platoon's reconnaissance missions, he must ensure that the platoon keeps its focus on the reconnaissance objective(s) and maintains the operational tempo of the mission. A platoon that loses either focus or tempo will quickly lose its combat effectiveness.

Orient on the reconnaissance objective

The scout platoon's scheme of maneuver is focused toward a specific objective or set of objectives. The objective may be a terrain feature, a specific area, or an enemy force; it may be designated by an NAI, checkpoint, or objective symbol. The platoon must maintain its orientation toward the objective, regardless of what it encounters, until the mission is complete. For the battalion scout, the objective is normally discussed in the commander's CCIR (which include his PIR), the R&S plan, or the execution portion (paragraph 3) of the OPORD. The cavalry scout's objective is covered in paragraph 3 of the troop commander's OPORD. It is critical that the scout leader completely understand the mission focus before he begins the planning process.

Report all information rapidly and accurately

Commanders base their decisions and plans on the battlefield information that scouts find and report during reconnaissance. Information loses value over time. Scouts must report all information exactly as they see it and as fast as possible. They must never assume, distort, or exaggerate; inaccurate information is dangerous. Information that the enemy is not in a certain location is just as important as where the enemy is.

Retain freedom to maneuver

Scouts must be able to maneuver on the battlefield. If the enemy fixes them, the scouts must free themselves; otherwise, they can no longer accomplish their mission. Scouts must continually maintain an awareness of tactical developments. They must employ effective techniques of tactical movement and react appropriately to unexpected situations. When contact is made, the platoon leader must seek to develop the situation at the lowest possible level, retaining the initiative, the ability to continue the mission, and the ability to maneuver his other elements.

Gain and maintain enemy contact

Scouts seek visual contact with the enemy on favorable terms. They employ sound tactical movement, effective target acquisition methods, and appropriate actions on contact to see the enemy first and thereby retain the initiative and control of the situation. Once scouts find the enemy, they maintain contact using all available means (sensors, radar, sound, and visual) until their commander orders them to do otherwise or as required by their specific instructions.

Develop the situation rapidly

Whether scouts run into an enemy force or an obstacle, they must quickly determine what they are up against. If it is the enemy, the scouts determine his size, composition, and activity. They find the flanks of the enemy force. They find any barriers or obstacles surrounding the enemy position and determine whether any other enemy forces can support the position. If the scouts encounter an obstacle, they find and mark a bypass or, if appropriate, execute or assist in a breach. This all must be done quickly, with a minimum of guidance from higher. Time is the scout's most precious resource; he cannot waste it if he is to achieve mission success.

SECTION 2 — RECONNAISSANCE METHODS

To reduce their vulnerability on the battlefield, scouts employ reconnaissance methods that achieve a balance between the acceptable level of risk and the security necessary to ensure mission accomplishment. Often this is expressed as a tradeoff between speed and security. The faster the reconnaissance, the more risk the scout takes and the less detailed the reconnaissance he conducts.

In conducting their missions, scouts must use all available resources, including reconnaissance methods that have been trained and rehearsed in detail. They must take every opportunity, both during peacetime and on the battlefield, to hone their reconnaissance skills. By the nature of their missions, scouts can never achieve perfect security; however, thorough knowledge of the various reconnaissance methods and their employment, combined with an understanding of a mission's particular METT-TC requirements, allows the scout leader to choose, and mix, reconnaissance methods that both maximize security and ensure mission accomplishment.

This section discusses several reconnaissance methods that scouts can employ. These methods have proven effective in a variety of situations and form a foundation for how to conduct reconnaissance. Scouts must use their experience, professional judgment, and common sense to analyze a given situation and employ the appropriate method. Usually, a mission will require that these methods be applied using a variety of techniques, combinations, and variations.

AGGRESSIVE VERSUS STEALTHY RECONNAISSANCE

In executing a reconnaissance mission, the scout platoon employs methods that reflect METT-TC considerations and that are geared to the particular task or unique capabilities of the reconnaissance element. The types of methods and actions that the platoon may employ during the course of a mission can be generally characterized as stealthy or aggressive. The majority of scout platoon missions will actually fall along a continuum between the two extremes of aggressive and stealthy actions.

Aggressive reconnaissance emphasizes rapid identification of the enemy's combat power by fighting for information. It is characterized by the employment of armored vehicles and the use of supporting fires. Scout platoon leaders must always remain aware that aggressive information-gathering can provide the enemy with an indication of friendly capabilities and future intentions.

Stealthy reconnaissance is a time-consuming process that emphasizes avoiding detection by the enemy. To be effective, a stealthy approach must rely on dismounted reconnaissance assets and maximum use of covered and concealed terrain.

Because of the nature of their organizations, HMMWV scouts will tend to conduct stealthy reconnaissance. CFV scouts, on the other hand, are more likely to conduct aggressive reconnaissance. Scout must realize that the two approaches to reconnaissance are not mutually exclusive. A combination of both methods can be useful based on templated and actual threat dispositions, changing tactical situations, varying weather and light conditions, and available resources.

RECONNAISSANCE PATROLS

Reconnaissance patrols provide timely and accurate information about the enemy and terrain. The patrol leader must have specific intelligence collection requirements for each mission.

An area reconnaissance patrol is conducted to obtain information about a specific location (such as a road junction, hill, bridge, or enemy position) and the area immediately around it. The location of the objective is designated either by grid coordinates or by a map overlay with a boundary line encircling the area.

A zone reconnaissance patrol is conducted to obtain information on all enemy forces, terrain, and routes within a specific zone. The zone is defined by boundaries.

A route reconnaissance patrol is conducted to obtain information about one route and adjacent terrain or to locate sites for emplacing obstacles. The reconnaissance is oriented on a road; on a narrow axis, such as an infiltration lane; or on a general direction of attack.

Reconnaissance patrols are also a critical part of platoon security missions. Area and zone reconnaissance patrols are executed to ensure the security of individual OP sites and to cover dead space and dismounted avenues of approach throughout the platoon's area of operations. When executed as part of a screen or other security mission, reconnaissance patrols are sometimes referred to as security patrols.

Area reconnaissance

In conducting an area reconnaissance, the patrol uses a series of surveillance and vantage points around the objective to observe it and the surrounding area. A scout platoon normally sends a squad on an area patrol. In rare cases, a section or the entire platoon may be required to conduct reconnaissance of a large area.

Area reconnaissance procedures. Before occupying an ORP, the patrol conducts a leader's reconnaissance to ensure that no enemy forces are in the area. Once this reconnaissance is completed, the patrol is signaled to move forward; it halts at the ORP and establishes security. The patrol leader and element leaders conduct a leader's reconnaissance of the objective to confirm the plan and then return to the ORP. The security element departs the ORP before the reconnaissance element. The security element

leader positions security teams at the ORP and on likely enemy avenues of approach leading into the objective area. See [Figure 3-1](#).

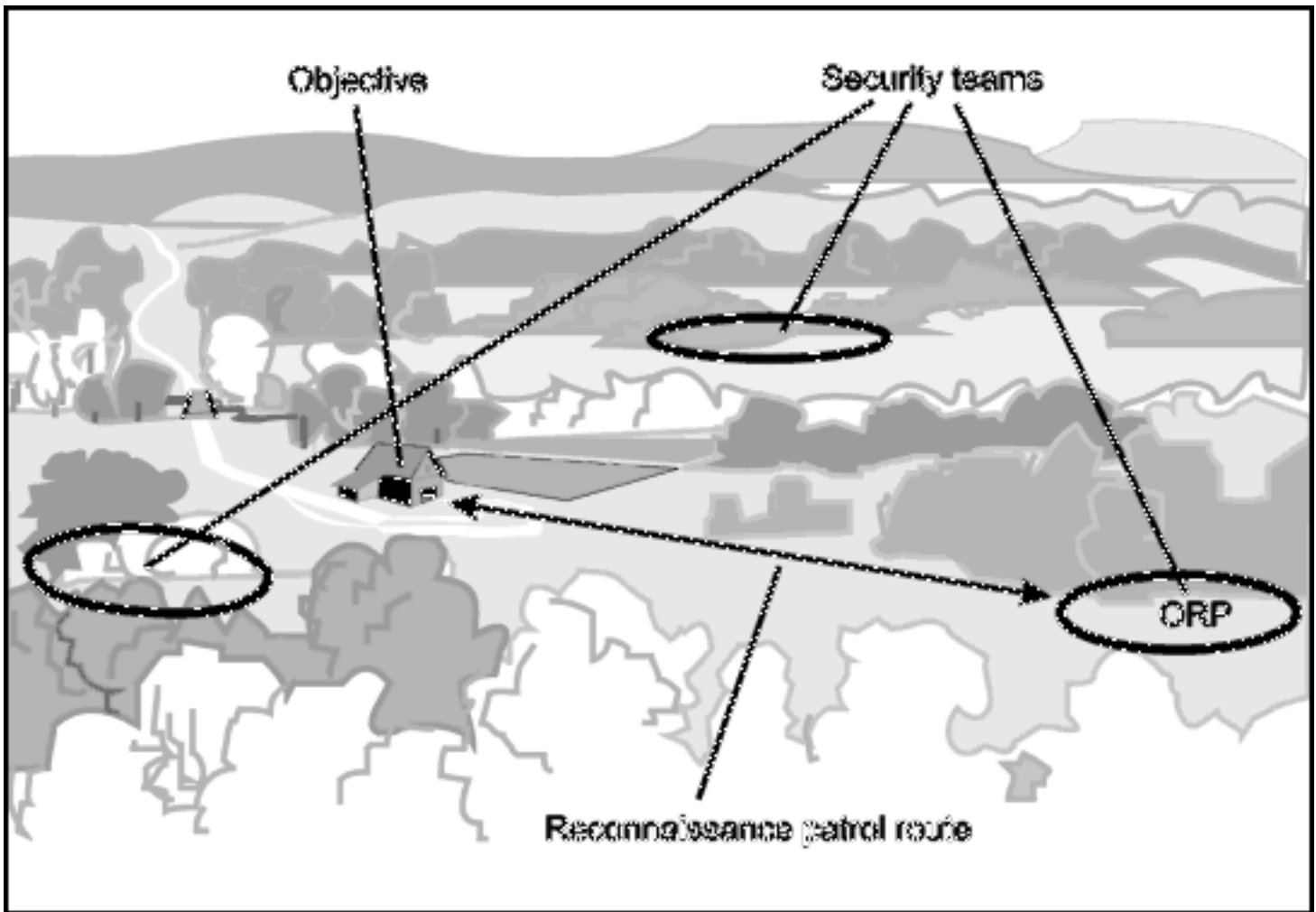

Figure 3-1. Area reconnaissance using separate reconnaissance and security elements.

Once the security teams are in position, the reconnaissance element departs the ORP, moving to several surveillance/vantage points around the objective. The reconnaissance element leader may decide to have a small reconnaissance team move to each surveillance/vantage point instead of having the entire element move as a unit from point to point. Once the objective has been reconnoitered, the elements return to the ORP and report the information. The patrol then returns to friendly lines.

The terrain may not allow the patrol to secure the objective area. In this case, the patrol leader leaves a security team in the ORP and combines the reconnaissance and security elements into several teams to reconnoiter the objective. These teams move to different surveillance/vantage points, from which they reconnoiter the objective. Once the objective has been reconnoitered, the teams return to the ORP and report the information. The patrol then returns to friendly lines. See [Figure 3-2](#).

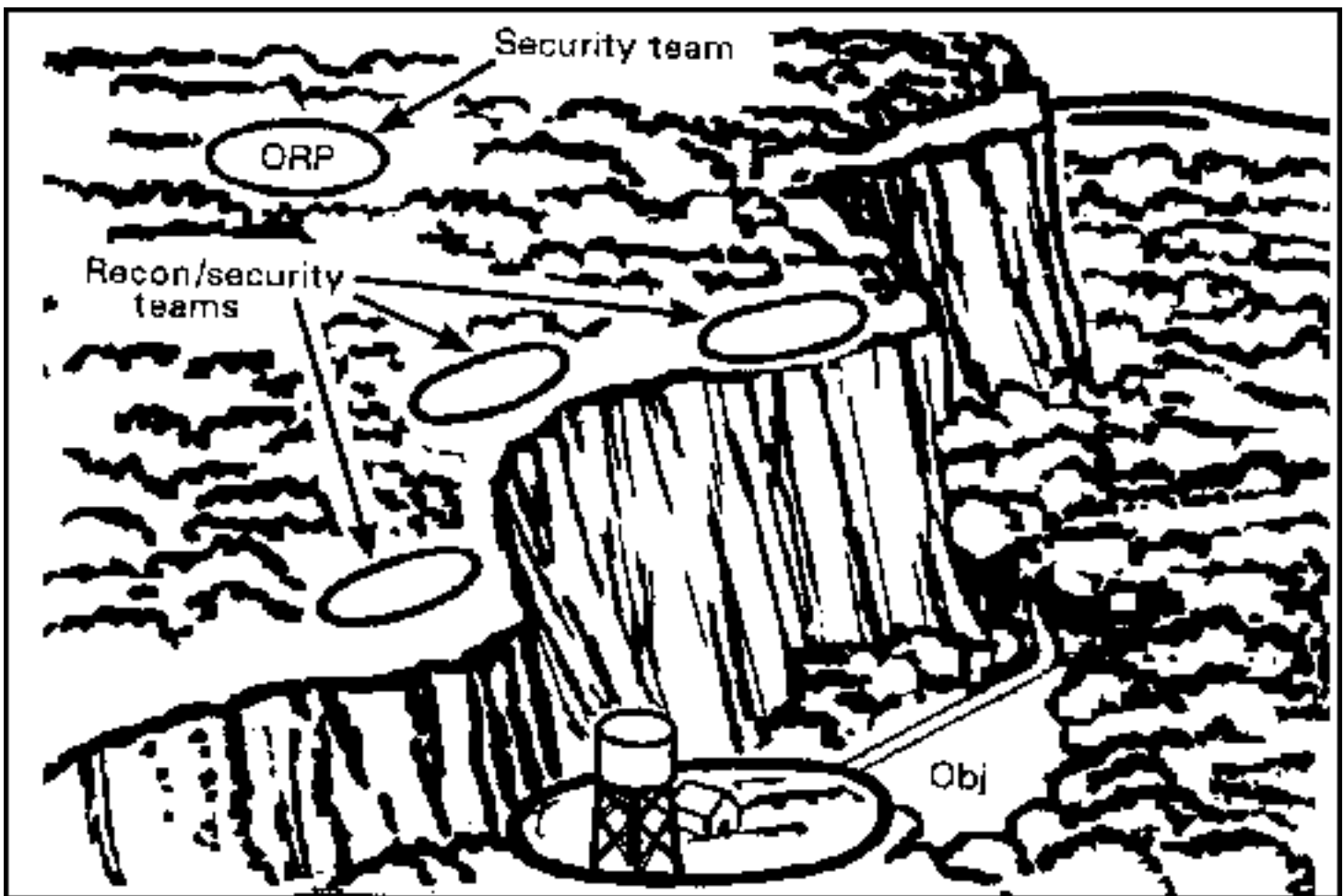

Figure 3-2. Using combined teams to reconnoiter the objective.

Distance factors. The area patrol can execute either long-range or short-range observation or surveillance of the objective. The following paragraphs examine factors that influence the distance at which the reconnaissance is conducted.

Long-range observation/surveillance. Whenever METT-TC permits the required information to be gathered from a distance, the patrol executes long-range observation or surveillance of the objective from an OP. The OP must be far enough from the objective to be outside enemy small arms range and local security measures.

Since the patrol does not move in close enough to be detected, long-range observation is the more desirable method for executing area reconnaissance. In addition, if the patrol is discovered by the enemy forces, friendly direct and indirect fires can be employed on the objective without endangering the patrol.

When information cannot be gathered from only one OP, successive OPs may be used. This is accomplished by squad-size reconnaissance patrols. The OPs must use available cover and concealment and have an unrestricted view of the objective.

Short-range observation/surveillance. If required information cannot be obtained by observing from a distance, the patrol moves closer to the objective. Short-range observation or surveillance is the technique of watching an objective from a position that is within the range of enemy local security measures and small arms fire.

This method can be executed by the platoon as a whole or by an individual section or squad. When the entire platoon is taking part in a short-range observation operation, the routes and area to be reconnoitered must be clearly defined.

Zone reconnaissance

There are three basic methods of conducting a zone reconnaissance: the fan method, the converging routes method, and the successive sector method. A dismounted scout squad can conduct a zone reconnaissance patrol of a narrow zone (less than 1 kilometer wide). A dismounted scout section or platoon can reconnoiter a zone up to 3 kilometers wide.

Fan method. The patrol leader first selects a series of ORPs throughout the zone from which to operate. When the patrol arrives at the first ORP, it halts and establishes security. The patrol leader then selects reconnaissance routes out from and back to the ORP, forming a fan-shaped pattern around the ORP. The routes must overlap to ensure that the entire area is reconnoitered.

The patrol leader then sends out reconnaissance elements along the routes. He does not send out all of his elements at once, keeping a small reserve in the ORP. (For example, if the patrol has three reconnaissance elements, only two are sent out. The other is kept as a reserve.) The patrol leader sends the elements out on adjacent routes. This keeps the patrol from making contact in two different directions. See [Figure 3-3](#).

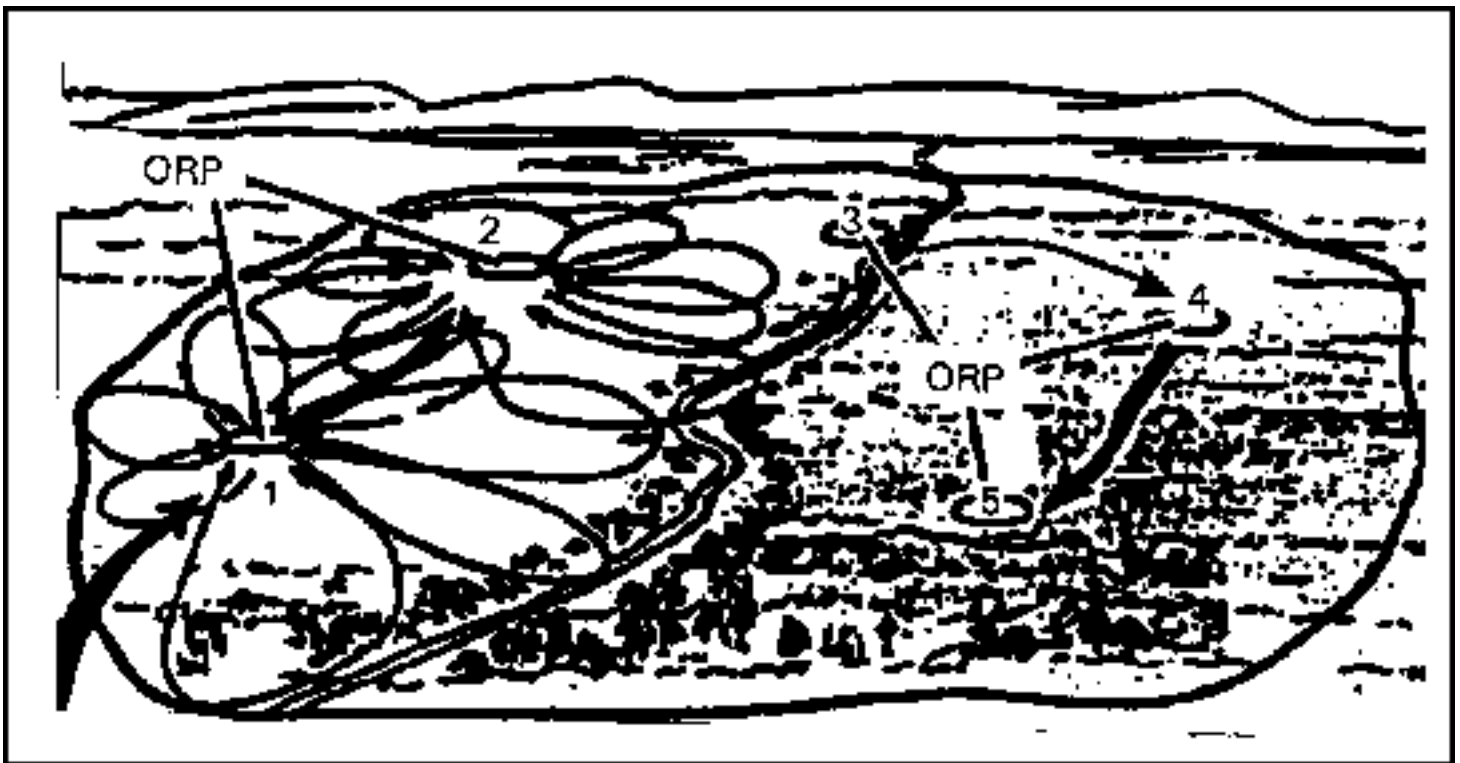

Figure 3-3. Fan method.

After the entire area (fan) has been reconnoitered, the patrol leader reports the information. The patrol then moves to the next ORP, and the fan process is repeated.

Converging routes method. The patrol leader first selects an ORP, then reconnaissance routes through the zone. He also selects a rendezvous point at which patrol members link up after their reconnaissance.

Once the patrol arrives at the ORP, it halts and establishes security. The patrol leader designates the following:

- The element that will handle each reconnaissance route.
- A linkup time at the rendezvous point.

Each reconnaissance element then reconnoiters its designated route, normally using the fan method. The patrol leader usually moves with the center element. The entire patrol links up at the rendezvous point at the designated time. The rendezvous point is secured in the same way as the ORP. The patrol reports its information at the rendezvous point, then returns to friendly lines. See [Figure 3-4](#).

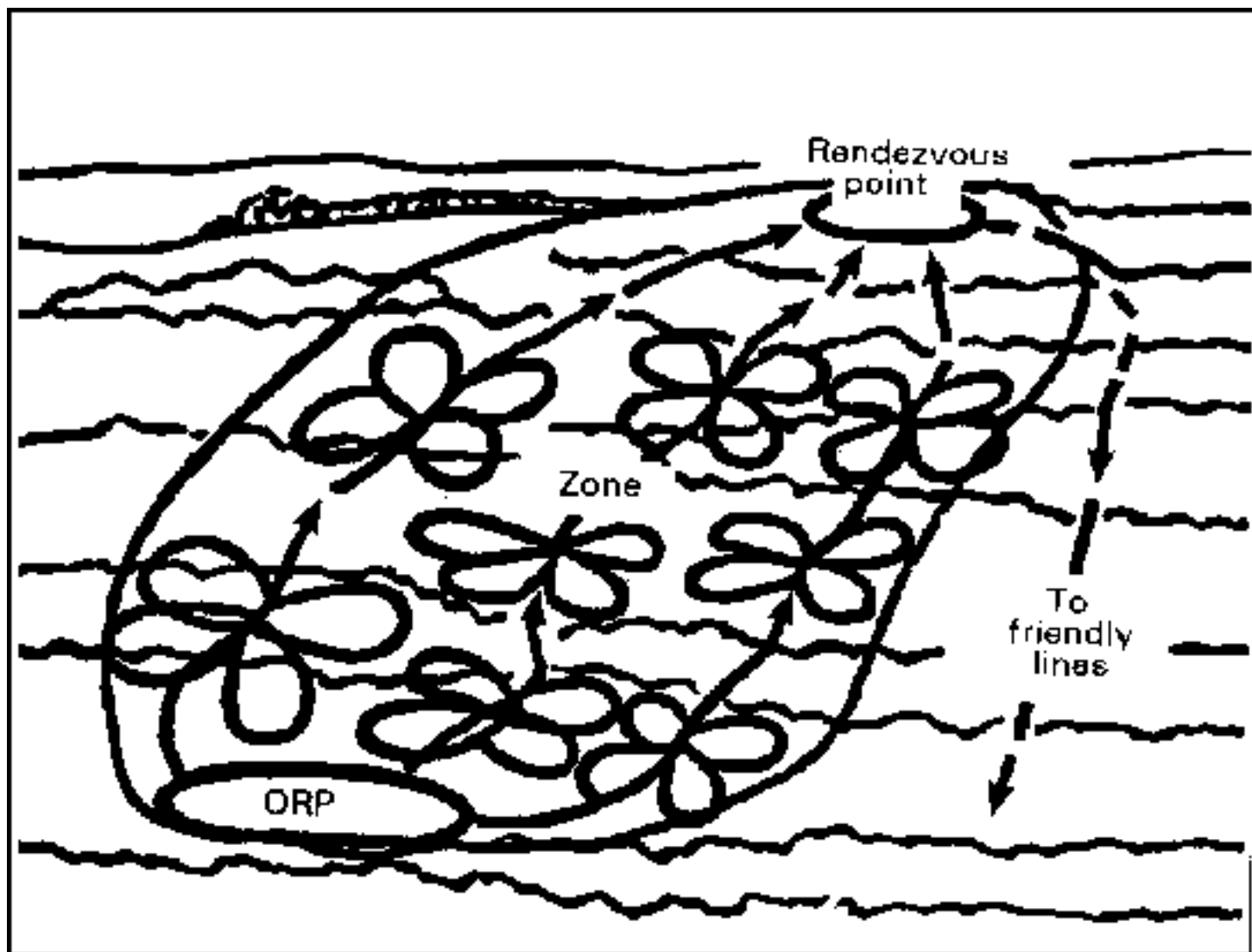

Figure 3-4. Converging routes method.

Successive sector method. This method is basically a continuation of the converging routes method. The patrol leader selects an initial ORP and a series of reconnaissance routes and rendezvous points. The actions of the patrol from each ORP to each rendezvous point are the same as in the converging routes method. Each rendezvous point becomes the ORP for the next phase. When the patrol links up at a rendezvous point, the patrol leader confirms the designated reconnaissance routes and the next rendezvous point and designates a linkup time. This sequence continues until the entire zone has been reconnoitered. Once the reconnaissance is completed, the patrol returns to friendly lines. See [Figure 3-5](#).

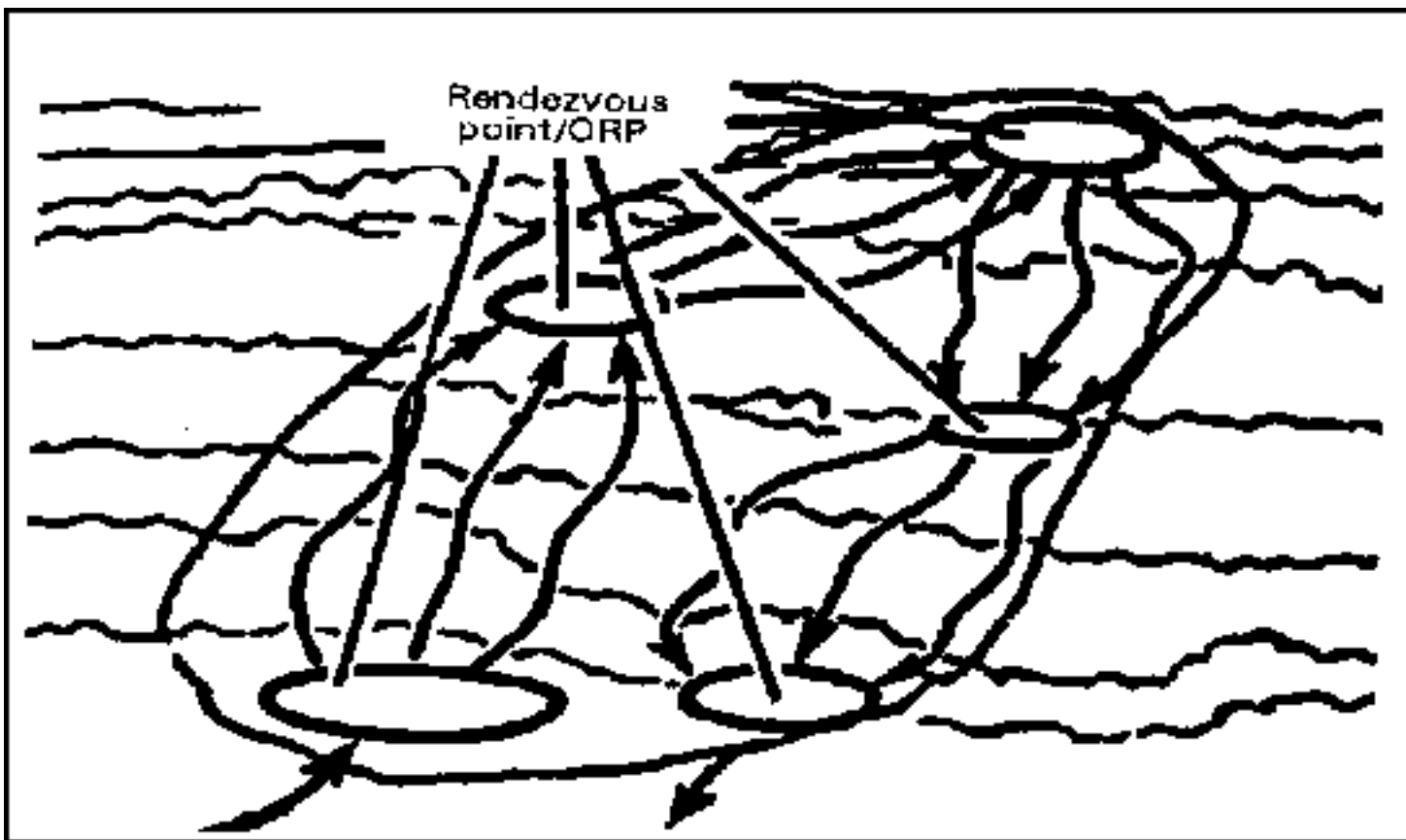

Figure 3-5. Successive sector method.

Route reconnaissance

The purpose of the route reconnaissance patrol is to provide detailed information on trafficability, enemy activity, NBC contamination, and the adjacent terrain from the viewpoint of both enemy and friendly forces. The preferred method for conducting a route reconnaissance is the fan method, described in the earlier discussion of area reconnaissance. The patrol leader must ensure that the fans are extensive enough to cover intersecting routes beyond direct fire range of the main route.

If all or part of the proposed route is a road, the patrol leader must treat the road as a danger area. If possible, the platoon should move parallel to the road using a covered and concealed route. As necessary, reconnaissance and security teams move close to the road to reconnoiter key areas and provide local security for reconnaissance teams and the patrol main body.

MOUNTED RECONNAISSANCE

Scouts frequently stay in their vehicles while conducting assigned reconnaissance tasks. Remaining mounted allows the scout platoon to conduct fairly detailed reconnaissance while maintaining the speed and momentum required for the operation. Mounted reconnaissance also allows the scouts to take advantage of the protection afforded by their vehicles.

Employment considerations

Mounted reconnaissance is normally used under these conditions:

- Time is limited.

- Detailed reconnaissance is not required.
- An air cavalry troop is performing coordinated reconnaissance tasks in support of ground forces.
- IPB provides accurate information on the enemy.
- Terrain is open.

Advantages and disadvantages

Speed and momentum are rarely necessary in a reconnaissance operation, but they are often critical to the successful execution of offensive operations that the reconnaissance mission supports. In addition to speed, mounted reconnaissance offers scouts the advantages of their reconnaissance vehicle. These advantages depend on the specific vehicle employed, but they can include firepower, armor protection, enhanced navigation and communications capability, and thermal optics.

The disadvantages of mounted reconnaissance include the loss of stealth due to the visual, noise, and thermal signatures of the vehicle and the loss of some detail because of restricted vision and impairment of the senses of smell and hearing. These disadvantages increase the risk to scouts as they conduct reconnaissance.

DISMOUNTED RECONNAISSANCE

The primary purpose of dismounted reconnaissance is to obtain detailed information about terrain features, obstacles, or enemy forces. In addition, scouts dismount and reconnoiter forward of their vehicle to provide security before moving through danger areas such as open spaces, hilltops, curves, or other blind spots on the battlefield. They also dismount to set up short- or long-duration OPs.

Employment considerations

In general, scouts conduct dismounted reconnaissance when the following conditions apply:

- Detailed reconnaissance is required.
- Stealth is required.
- Enemy contact is expected or visual contact has been achieved.
- Restricted terrain is encountered.
- Time is available.
- Danger areas are encountered.
- Security is the primary concern.
- IPB indicates close proximity to enemy positions.

Dismounted scouts provide security for each other as they move. Ideally, two scouts work together when operating dismounted. When only a single scout dismounts, he should never move out of supporting distance of the vehicle.

Advantages and disadvantages

Dismounted reconnaissance is the preferred method when stealthy movement is desired. Scouts on foot benefit from the concealment offered by folds in the terrain; in addition, they do not emit a significant visual or audio signature. Dismounted reconnaissance techniques allow the scout platoon to observe

enemy vehicles and soldiers at close range without being detected. Scouts conducting dismounted reconnaissance can also quickly transition to a stationary OP for a short period of time without suffering any loss of effectiveness.

Disadvantages of dismounted reconnaissance include a relatively slow rate of movement for personnel on foot, extensive requirements for detailed preliminary planning and coordination, and considerable risk to scouts who are conducting dismounted operations. Unless they establish a radio relay, scouts cannot conduct dismounted reconnaissance in depth because of the relatively short range of FM manportable communications systems. When dismounted reconnaissance takes place during hours of darkness, target acquisition depends largely on hand-held night vision devices, whose capabilities can be degraded.

Tools for dismounted reconnaissance

Dismounted scouts employ a variety of equipment and other tactical tools to enhance their capability to report information accurately and to call for and adjust indirect fires. At a minimum, they carry the following items:

- SOPs.
- Personal weapons.
- Communications equipment.
- SOI extracts.
- Maps.
- A compass.
- Binoculars (and night vision devices, if necessary).

RECONNAISSANCE BY FIRE

In reconnaissance by fire, scouts place direct and/or indirect fire on positions where there is a reasonable suspicion of enemy occupation; the goal is to cause the enemy to disclose his presence by moving or by returning fire. Scouts use this reconnaissance method when enemy contact is expected and time is limited or when the scouts cannot maneuver to develop the situation.

Employment considerations

Examples of enemy locations and/or contact situations in which reconnaissance by fire may be employed include the following:

- Contact with a natural or man-made obstacle.
- Detection of an obvious kill zone.
- A suspected enemy position that fits the situational template.
- Signs of recent activity (such as track marks or trash).
- Bunker complexes that may or may not be occupied.

When such evidence exists, the scouts should maneuver to observe from different directions. When the decision is finally made to use reconnaissance by fire, weapons should be used in the following priority:

- Indirect fire.

- Loose machine gun.
- 25-mm chain gun, MK-19, or mounted machine gun.
- TOW.

Reconnaissance by fire eliminates any element of surprise the scouts may have had, and it is likely to give the enemy detailed knowledge of their location. It may, however, reduce the chance of scouts being ambushed within established kill zones.

Reconnaissance by fire does not work in all cases. For example, disciplined troops in prepared positions will not react to the scouts' fires. As a result, reconnaissance by fire must not entail the indiscriminate use of direct and indirect fires at all wood lines and hilltops in the hopes of causing the enemy to react. The enemy will recognize this for what it is; he will not react to it. This also wastes valuable ammunition.

Types of reconnaissance by fire

Scouts can conduct reconnaissance by fire either by calling for and adjusting indirect fire or by employing their own direct fire systems.

Indirect fire. Reconnaissance by indirect fire provides security for the scouts because it does not disclose their exact position; in addition, all scouts are available to observe the effects of the fire.

Reconnaissance by indirect fire has disadvantages as well. Indirect fire requires more coordination and communication than direct fire; it is less responsive and may be less accurate than direct fire. Indirect fire is subject to factors beyond the control of the scout platoon, such as the supporting unit's Class V supply status, counterbattery threats, and command approval. Additionally, the effects of indirect fire may obscure the scout's vision.

Direct fire. Scouts can use their organic weapons to place accurate direct fires on suspected enemy positions. This technique is likely to provoke a rapid enemy response, but it discloses the scouts' position. Direct fire is limited by the maximum effective range of the weapon used and by the scouts' limited supply of ammunition.

Scouts must work together when employing direct fire. The scout who fires is not in the best position to observe because of obscuration and the necessity to move to a covered position after firing. Another scout, in another position, must observe for an enemy reaction. The observing scout remains undetected and can accurately report enemy information. When using direct fire, the scout platoon leader should also plan to place indirect fires on suspected positions for use as suppression if the enemy responds in strength.

AERIAL RECONNAISSANCE

When available, aerial reconnaissance can be employed to complement ground reconnaissance. Aerial assets are an integral part of reconnaissance operations in division and regimental cavalry organizations; ground scouts must synchronize their reconnaissance effort with that of the air cavalry assets in the squadron or regiment. Ground scouts in the armor or mechanized battalion task force may also conduct reconnaissance with aviation assets. In this case, helicopters from the attack helicopter battalion or the divisional cavalry squadron may conduct the aerial reconnaissance.

In each type of organization, the ground scout must understand the capabilities and limitations of aerial reconnaissance. Air-ground coordination is vital to mission success and fratricide reduction. If possible, the scout platoon leader should arrange to conduct face-to-face coordination with the air troop commander or platoon leader. If this is not practical, radio coordination becomes essential.

When operating together, aerial and ground reconnaissance assets can compensate for each other's limitations and significantly increase the effectiveness of their combined reconnaissance effort. Aerial reconnaissance, as conducted by air cavalry elements, is the fastest form of reconnaissance. It is also terrain-independent; air assets can reconnoiter areas that may be difficult or impossible for ground scouts to reach.

On the other hand, aerial reconnaissance is limited by weather conditions, the night-vision capability of the particular aircraft's sensors, fuel requirements, ADA threats, and the detail with which terrain can be observed. Generally, aerial reconnaissance will not identify stationary enemy elements smaller than platoon size or moving elements of squad size or smaller, although this can vary widely depending on the terrain and available equipment.

NOTE: Refer to [Chapter 6](#) of this manual for further details on air/ground reconnaissance integration.

SECTION 3 — ROUTE RECONNAISSANCE

The scout platoon conducts a route reconnaissance to gain detailed information about a specific route or axis and the terrain on both sides of the route that the enemy could use to influence movement on the route. It is usually tasked with this type of reconnaissance when the commander wants to use a certain route, but first wants to make sure the route is free of obstacles and enemy forces and will support the movement of his vehicles.

CRITICAL TASKS

During a route reconnaissance, the scout platoon must be prepared to accomplish a wide range of reconnaissance tasks. Based on the time available and the commander's intent, however, the platoon may be directed to conduct the reconnaissance to acquire specific information only. To be ready for either type of situation, the scout platoon leader must clearly understand these critical tasks that may have to be accomplished in route reconnaissance:

- Determine the trafficability of the route.
- Reconnoiter, to the limit of direct fire range, terrain that dominates the route.
- Reconnoiter all built-up areas along the route.
- Reconnoiter, to the limit of direct fire range, all lateral routes.
- Inspect and classify all bridges on the route.
- Locate fords or crossing sites near all bridges on the route.
- Inspect and classify all overpasses, underpasses, and culverts.
- Reconnoiter all defiles along the route.
- Locate minefields, and other obstacles, along the route.

- Locate a bypass around built-up areas, obstacles, restrictions, and contaminated areas.
- Report route information.
- Find and report all enemy forces that can influence movement along the route.

TECHNIQUES

Because of the number of critical tasks that must be accomplished, a cavalry scout platoon can conduct a detailed reconnaissance of only one route. A battalion scout platoon may be able to handle two routes if the reconnaissance is limited to trafficability only. A scout platoon can reconnoiter a route by itself or may operate as part of a larger force such as a cavalry troop. The following discussion outlines one technique of getting all the tasks accomplished as rapidly and securely as possible.

The order the platoon leader receives specifies the route the platoon must reconnoiter and defines the route from SP to RP. Additionally, the order may specify platoon boundaries, phase lines, an LD, and a limit of advance (LOA) or reconnaissance objective. These control measures specify how much terrain on both sides of the route the platoon must reconnoiter and where the operation must begin and end.

The boundaries are drawn on both sides. They include the terrain that dominates the route, usually extending out about 2.5 to 3 kilometers. This ensures that the scouts reconnoiter all terrain the enemy could use to influence movement along the route. The LD is drawn from one boundary to the other behind the SP. This allows the platoon to cross the LD and be fully deployed before reaching the route. The LOA or objective is placed beyond the RP on the last terrain feature that dominates the route or at a location out to about 3 kilometers.

NOTE: Refer to [Figure 3-6](#) for an illustration of control measures for the route reconnaissance operation.

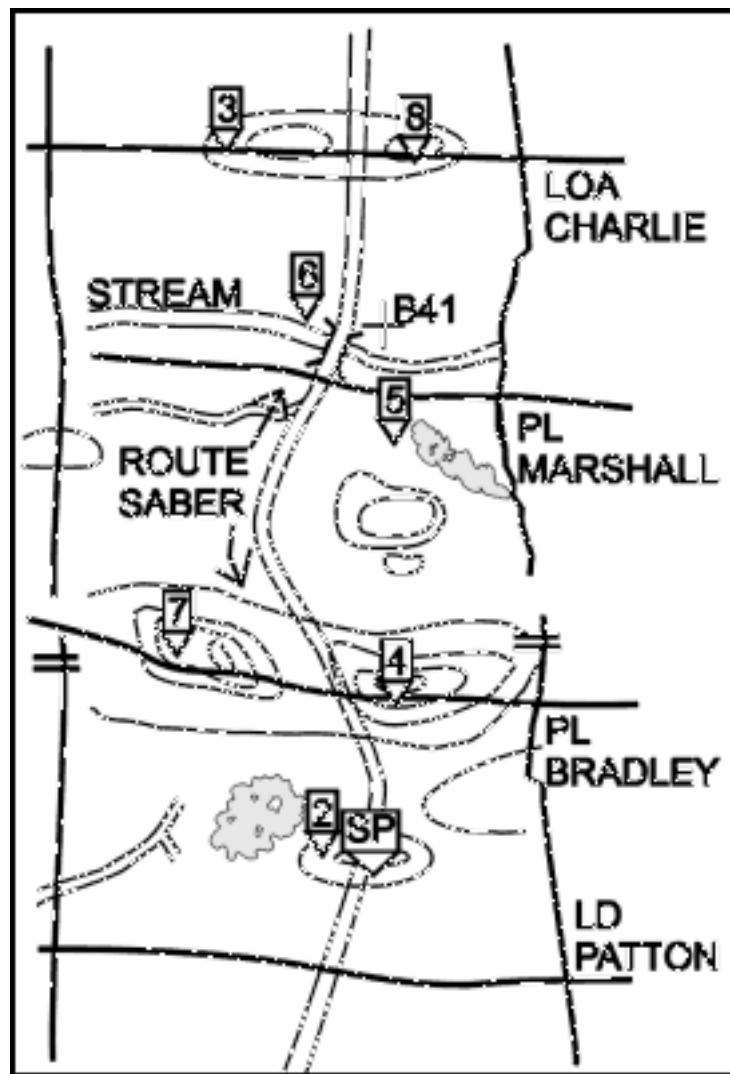

Figure 3-6. Control measures.

The platoon leader may add additional phase lines, contact points, and checkpoints to the graphics he receives from his commander. Phase lines are used to help control the maneuver of the platoon. The contact points ensure that the sections or squads maintain contact at particular critical points. Checkpoints are used along the route or on specific terrain to control movement or to designate areas that must be reconnoitered.

In coordination with the FSO, the platoon leader plans artillery targets on known or suspected enemy positions and on dominant terrain throughout the area of operations. The platoon leader evaluates the factors of METT-TC to select a platoon organization. He must ensure that at least one section has responsibility for reconnoitering the route.

The three-section organization is usually the type best suited for reconnaissance of one route. One section reconnoiters the terrain left of the route, another covers the terrain on the right side of the route, and the third section reconnoiters the route and controls the movement of the other two. In this organization, the platoon leader's section has specific responsibility to reconnoiter the route. (See [Figure 3-7.](#))

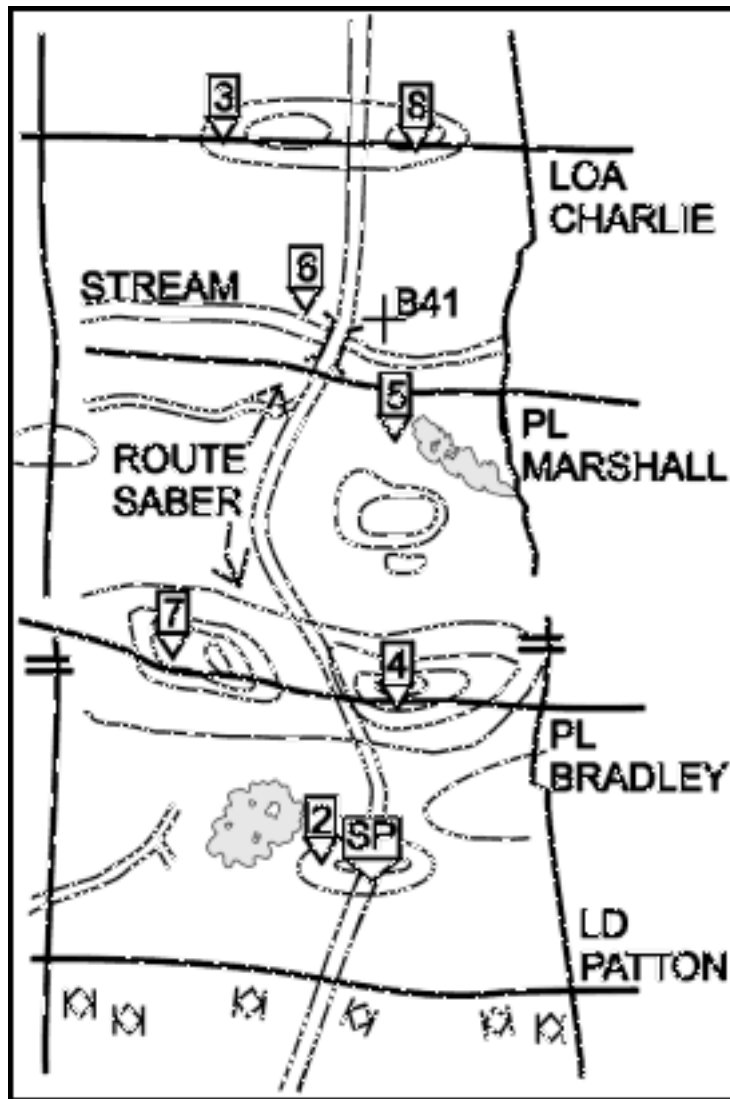

Figure 3-7. Three-section reconnaissance organization.

EXAMPLE OF A ROUTE RECONNAISSANCE

The following example of route reconnaissance is for a cavalry scout platoon. [Figure 3-8](#) illustrates this situation.

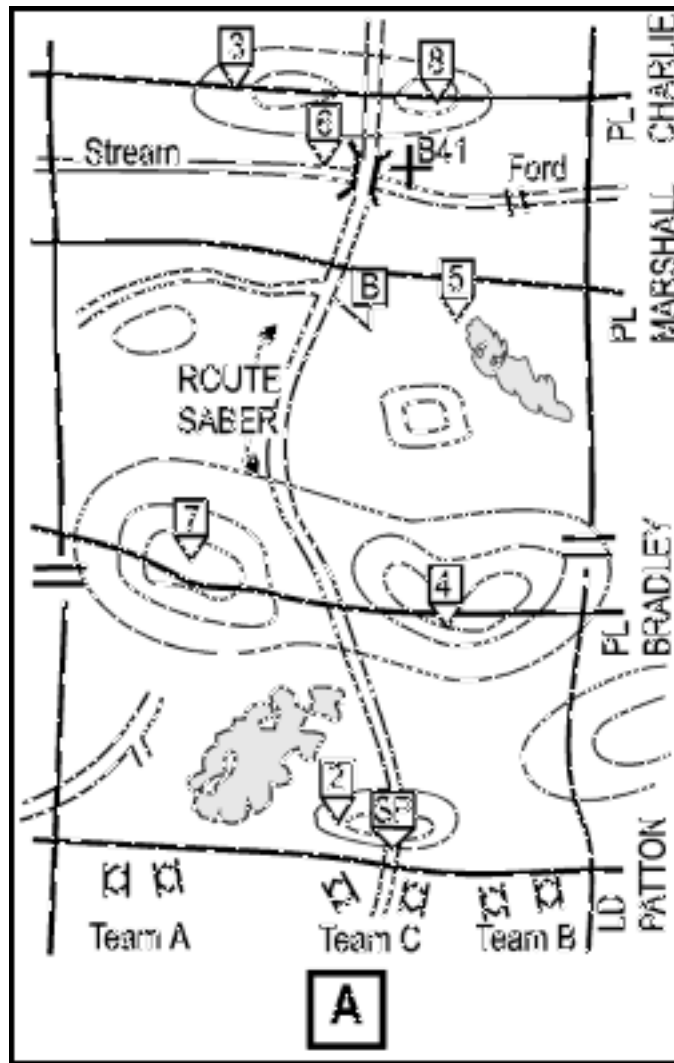

Figure 3-8A. Route reconnaissance.

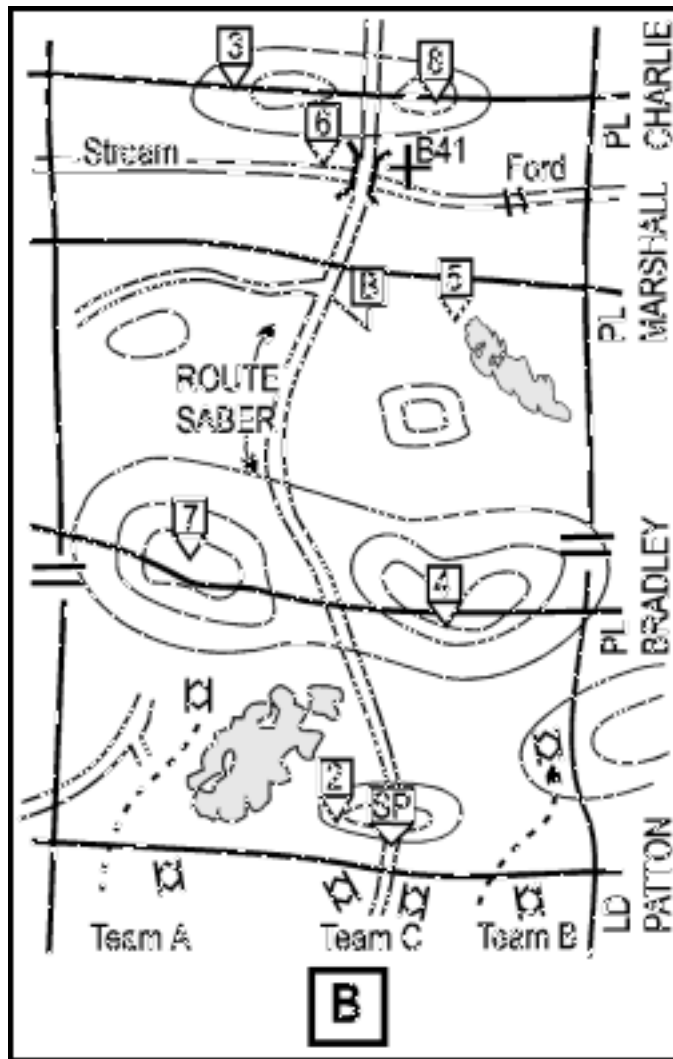

Figure 3-8B. Route reconnaissance (continued).

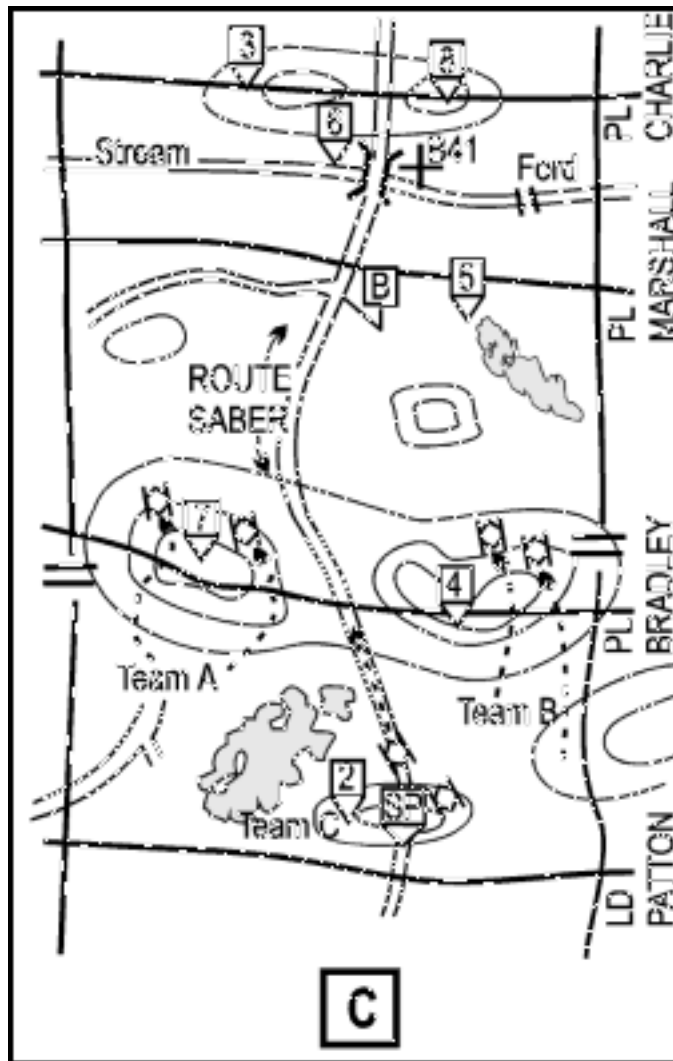

Figure 3-8C. Route reconnaissance (continued).

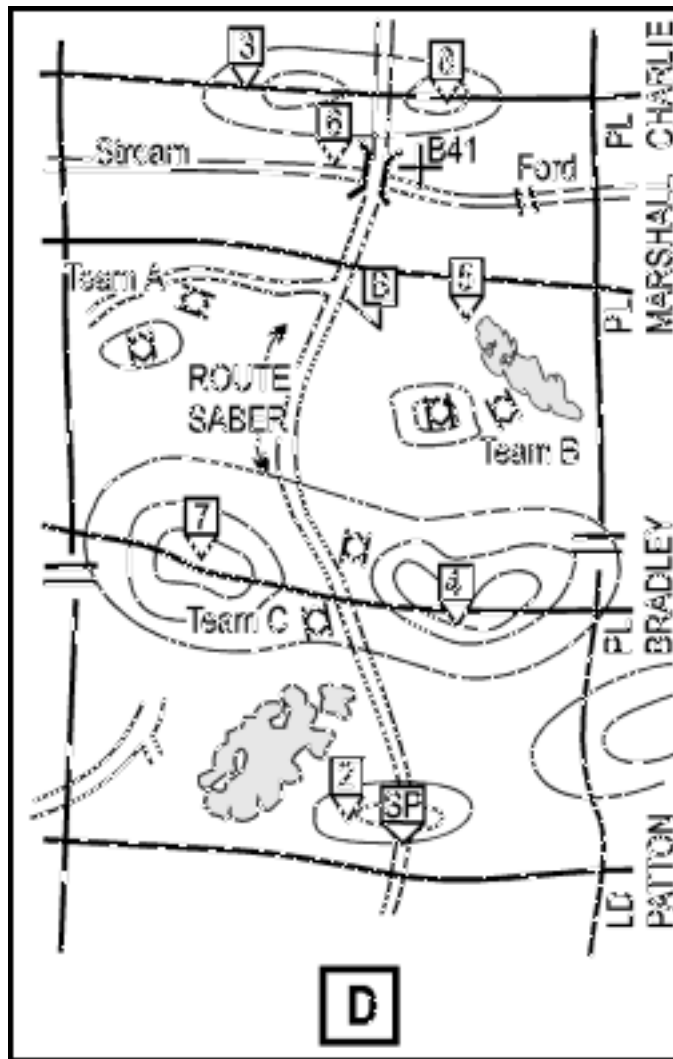

Figure 3-8D. Route reconnaissance (continued).

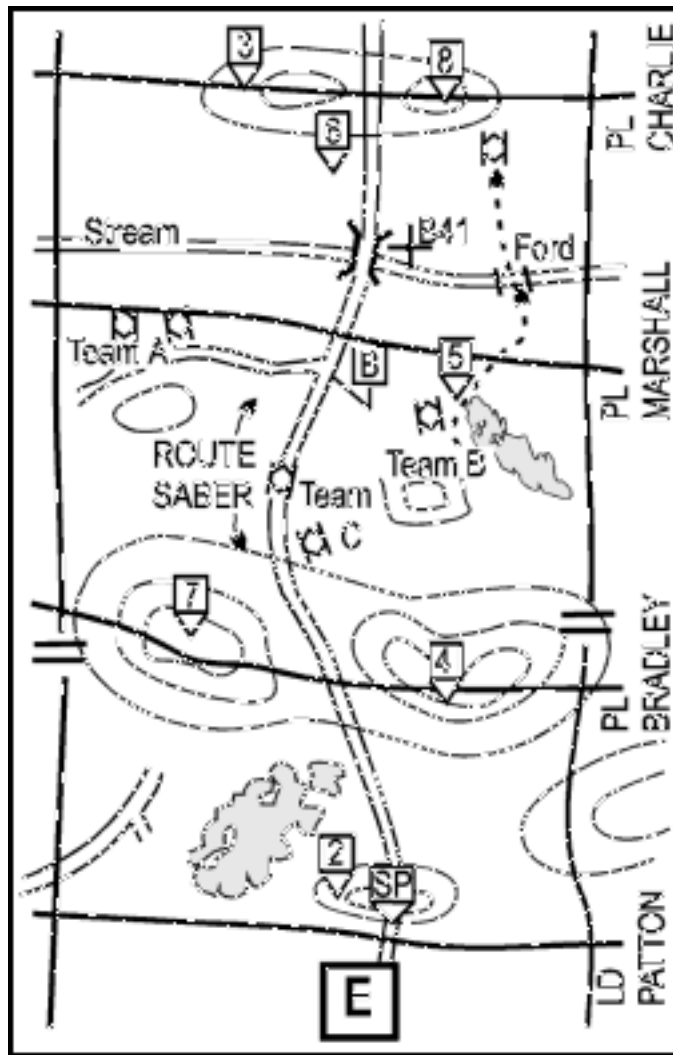

Figure 3-8E. Route reconnaissance (continued).

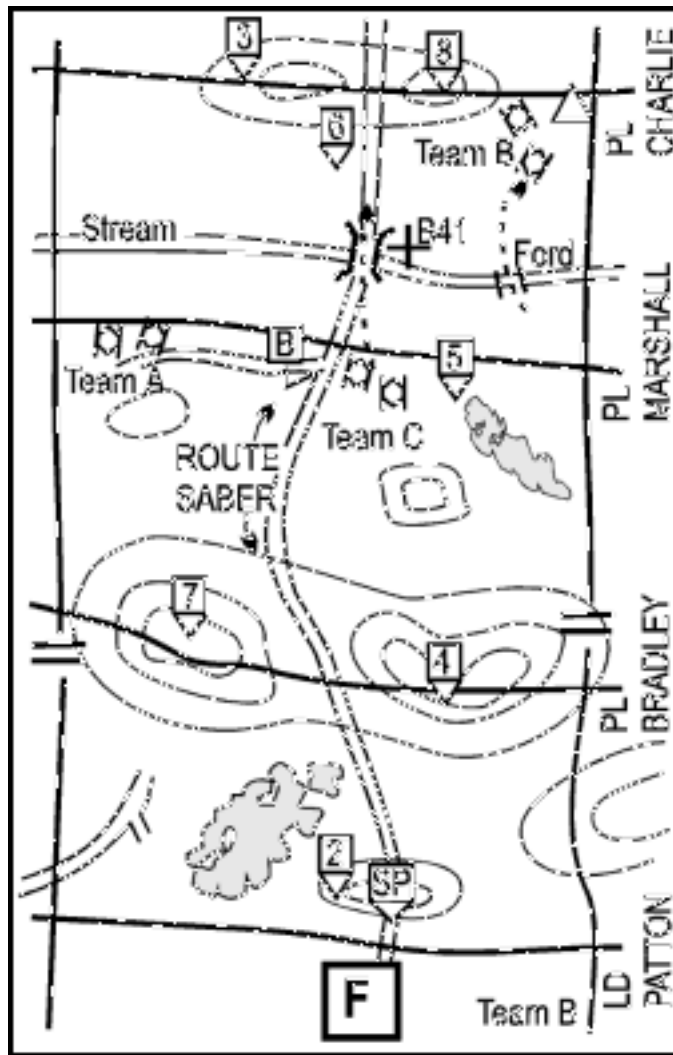

Figure 3-8F. Route reconnaissance (continued).

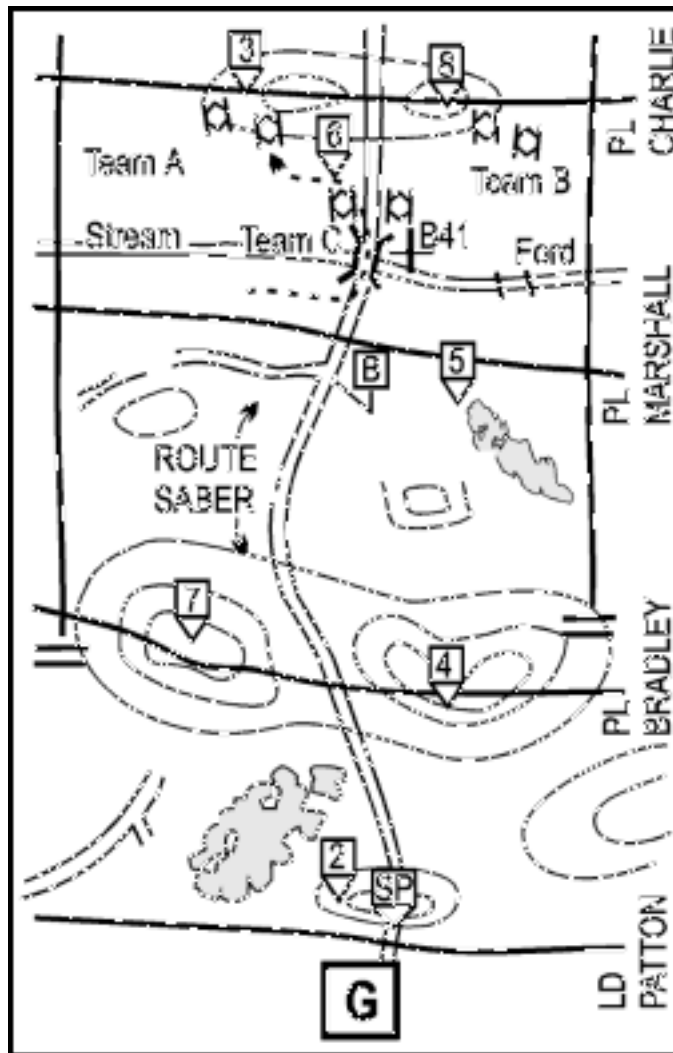

Figure 3-8G. Route reconnaissance (continued).

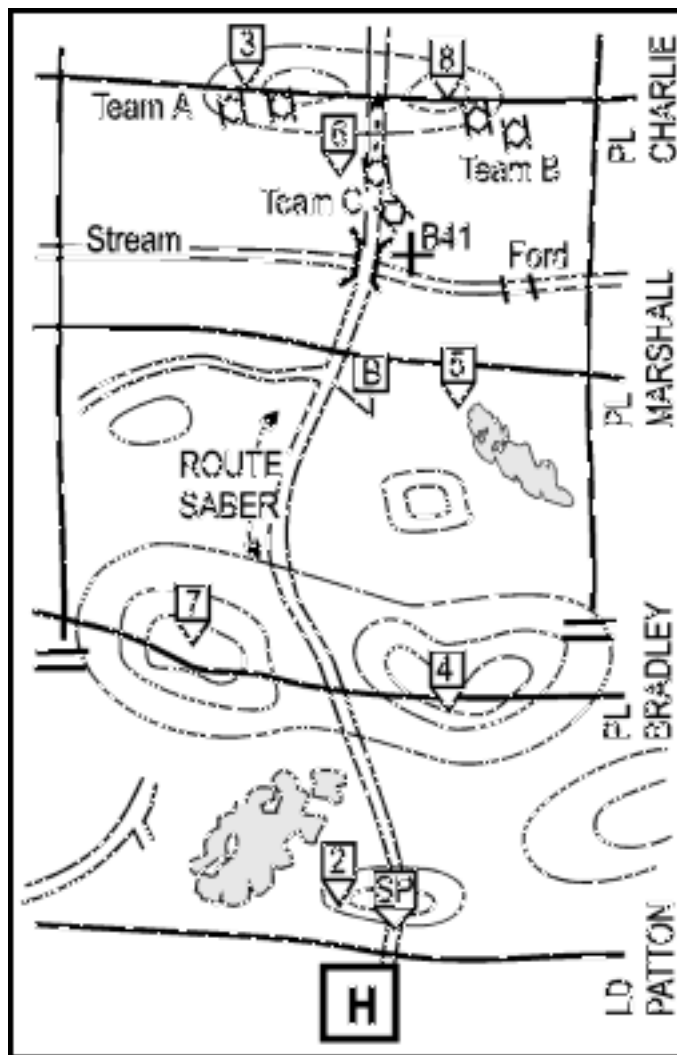

Figure 3-8H. Route reconnaissance (continued).

When the scout platoon conducts a route reconnaissance, it often deploys in a vee formation because of the very focused nature of this mission. Section A is positioned to the left of the route, Section B to the right, and Section C in the center of the zone along Route SABER. The platoon should deploy into formation before reaching LD PATTON so that it crosses the LD at the specified time. The platoon leader reports crossing the LD when the first element crosses it (see [Figure 3-8A](#)).

The platoon leader is responsible for the scout platoon's movement through the sector. He uses checkpoints to control the movement and to focus on key terrain or features that may influence movement along the route.

Section C should be positioned along the route so it can observe the route, and one element of the section must physically drive the entire route. Unless the sector is very small or very open, the platoon will move as individual sections. As the sections move to the checkpoints, they maneuver in a zigzag pattern to reconnoiter the sector and accomplish all critical tasks of a route reconnaissance. The lead sections, on the flanks, must observe the route and report any restrictions or obstacles that may restrict movement along the route. Visually clearing the route before Section C travels it provides for better security and allows Section C to concentrate on the critical reconnaissance tasks. As the sections maneuver toward the checkpoints, they maintain visual contact with the route (see [Figure 3-8B](#)).

After both lead sections report "SET" and are in overwatch positions, Section C begins the route reconnaissance (see [Figure 3-8C](#)). As the section leader moves along Route SABER, his wingman maneuvers to provide overwatch for the section leader. During the reconnaissance, the platoon leader normally must send a route classification of the trafficability at intervals designated by the commander. A route report may be required only if there is a significant or unexpected change in the route's makeup.

As Section C reconnoiters the route, the other sections move ahead, reconnoitering critical and dominant terrain. The platoon leader controls and coordinates the movement of all three sections. He must ensure that the flank sections remain far enough forward of Section C to provide security. The flank sections have also been assigned responsibility for covering lateral routes. Section A is executing a lateral route and will use contact point B to tie in with Section C on Route SABER (see [Figure 3-8D](#)).

The platoon order must address actions on the approach to the stream. In this case, the two flank sections have been given the task of locating bypasses in the form of fords or unmapped bridges. Section B is successful in locating a ford; Section A is not. Section B conducts a ford reconnaissance, following the steps used for obstacle and restriction reconnaissance, and then continues its mission (see [Figure 3-8E](#)).

Section C continues its route reconnaissance along the route until it approaches the bridge site. It then executes a bridge reconnaissance to establish trafficability of the bridge. Section A occupies an overwatch position while Section C reconnoiters the bridge. Section B continues its reconnaissance one terrain feature beyond the stream and then occupies a short-duration OP (see [Figure 3-8F](#)).

Section C completes its bridge reconnaissance and establishes local security on the approaches to the far side of the bridge. Once this is complete, Section A passes across the bridge and through Section C, continuing its reconnaissance of the dominant terrain on the left flank of the route (see [Figure 3-8G](#)). Once Section A is set in sector, the platoon resumes its route reconnaissance to the LOA (see [Figure 3-8H](#)).

SECTION 4 — ZONE RECONNAISSANCE

Commanders normally assign a zone reconnaissance or infiltration mission to the scout platoon when they need detailed information before maneuvering their forces through the zone. The reconnaissance provides the commander with a detailed picture of how the enemy plans to defend the zone, enabling him to choose the appropriate COA. There are two types of zone reconnaissance: terrain-oriented and force-oriented.

The scout platoon conducts terrain-orientated zone reconnaissance to gain detailed information about routes, terrain, and resources within the assigned zone. This is the most thorough and complete reconnaissance mission and therefore is very time-intensive. It is common for scouts executing a zone reconnaissance in terrain with heavy vegetation to advance at only about 1.5 kilometers per hour.

The scout platoon conducts force-oriented zone reconnaissance to gain detailed information about enemy forces within the zone. As the platoon conducts this type of zone reconnaissance, its emphasis is on determining the enemy's locations, strengths, and weaknesses.

Terrain- and force-oriented missions are not mutually exclusive. METT-TC factors will dictate if these types of reconnaissance are conducted separately or in conjunction with each other.

CRITICAL TASKS

Scouts must accomplish numerous critical tasks during the zone reconnaissance. Their primary critical tasks include the following:

- Find and report all enemy forces within the zone.
- Reconnoiter specific terrain within the zone.
- Report reconnaissance information.

In addition to their primary tasks, the scouts must be prepared to conduct other tasks as directed by the higher commander. These additional tasks may include the following:

- Reconnoiter all terrain within the zone.
- Inspect and classify all bridges within the zone.
- Locate fords or crossing sites near all bridges in the zone.
- Inspect and classify all overpasses, underpasses, and culverts.
- Within capability, locate all minefields and other obstacles in the zone, reduce or breach them, and clear and mark lanes.
- Locate bypasses around built-up areas, obstacles, and contaminated areas.

TECHNIQUES

Zone reconnaissance is very time-consuming. Unless the orders specify otherwise, all critical tasks listed in the previous discussion are implied in the zone reconnaissance mission statement. When speed is the primary concern, commanders must modify the mission statement or prioritize the critical tasks for the platoon leader. The width of the zone is determined by the road network, terrain features, anticipated enemy activity, and time available to accomplish the mission. A scout platoon can effectively reconnoiter a zone that is 3 to 5 kilometers wide. If the platoon is stretched any farther than this, it quickly loses the capability to accomplish critical tasks and move securely.

When a scout platoon leader receives a zone reconnaissance mission, the order will define the zone by lateral boundaries, an LD, and an LOA or objective. The parent unit may include additional phase lines or other graphic control measures within the zone to help control the maneuver of the units.

The platoon leader analyzes the mission to determine what must be accomplished. He evaluates any information he has received about the enemy in the IPB to determine what enemy activity he should expect to encounter. He then analyzes the terrain by conducting a map reconnaissance and by examining any aerial photographs or information from other units to determine what types of terrain the platoon must operate over. This reconnaissance is important in identifying areas the enemy could occupy based on observation capability, fields of fire, and natural obstacles.

The platoon leader completes troop-leading procedures and comes up with a COA to accomplish his assigned mission. He may add phase lines on easily identifiable terrain through the zone to help control the maneuver. He places checkpoints in specific areas that must be reconnoitered or where they will aid in controlling the operation. If the terrain is mixed, with both extensive dead space and easily identifiable features, he may use boundaries to designate areas of responsibility for each section. He will place

contact points at critical areas where he wants to ensure that sections maintain contact.

The platoon leader works with the FSO to plan indirect fire targets to support the platoon's scheme of maneuver. As a minimum, they should plan targets on known or suspected enemy positions.

Depending on the type of scout platoon and applicable METT-TC considerations, the platoon can conduct the zone reconnaissance using a two- or three-section organization. It must deploy to cover the entire zone. It usually operates in a zone it knows very little about, so the COA must allow for flexibility, responsiveness, and security as it moves.

The platoon leader deploys the scout sections on line across the LD and assigns each section a zone within the platoon zone for which it is responsible. He uses phase lines, checkpoints, contact points, or TIRS to ensure that the platoon reconnoiters the entire zone. He ensures that the scout sections remain generally on line; this prevents development of significant gaps that a moving enemy could exploit. Scouts dismount as necessary to gather detailed information, reconnoiter danger areas, or move through areas that are not accessible to the vehicles. The platoon continues to reconnoiter the zone until it reaches the LOA or the final reconnaissance objective.

EXAMPLE OF A ZONE RECONNAISSANCE

The following example of zone reconnaissance is for a battalion scout platoon. [Figure 3-9](#) illustrates this situation.



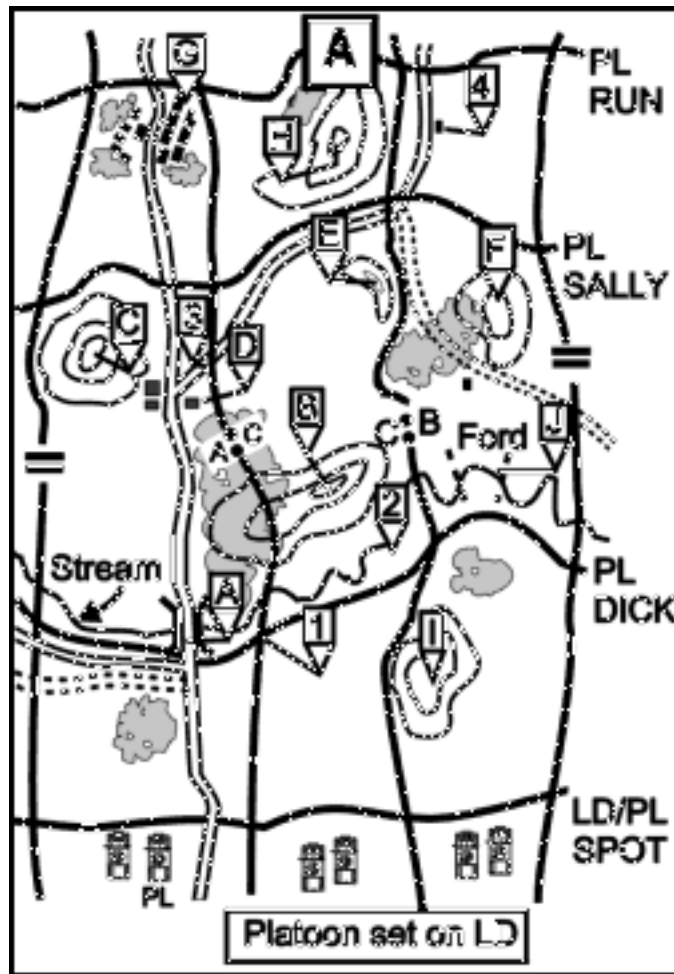

Figure 3-9A. Zone reconnaissance.

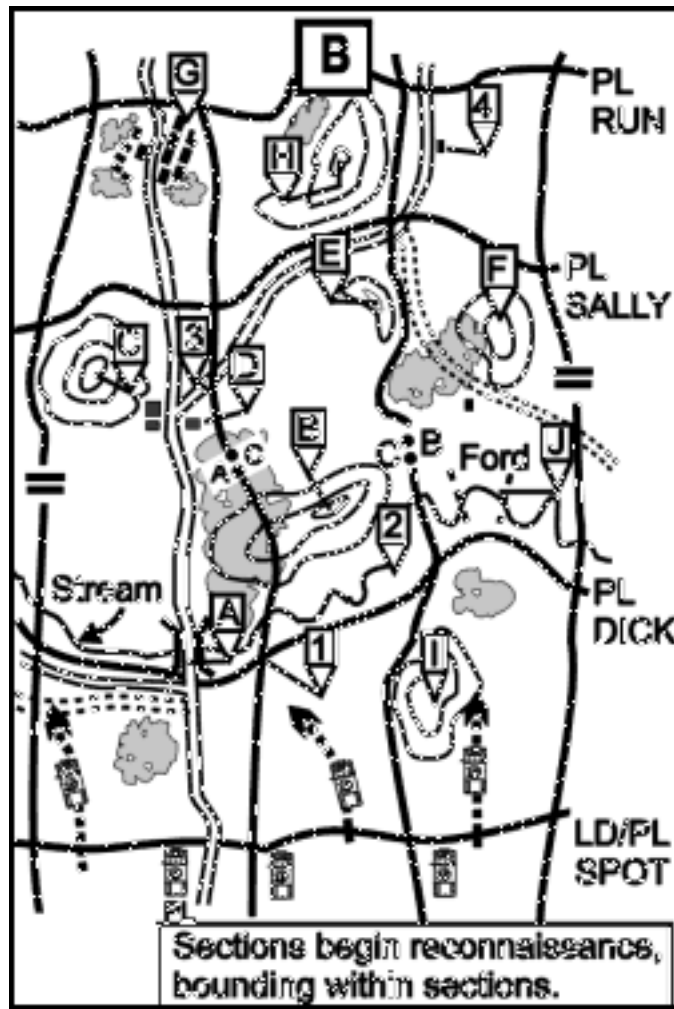

Figure 3-9B. Zone reconnaissance (continued).

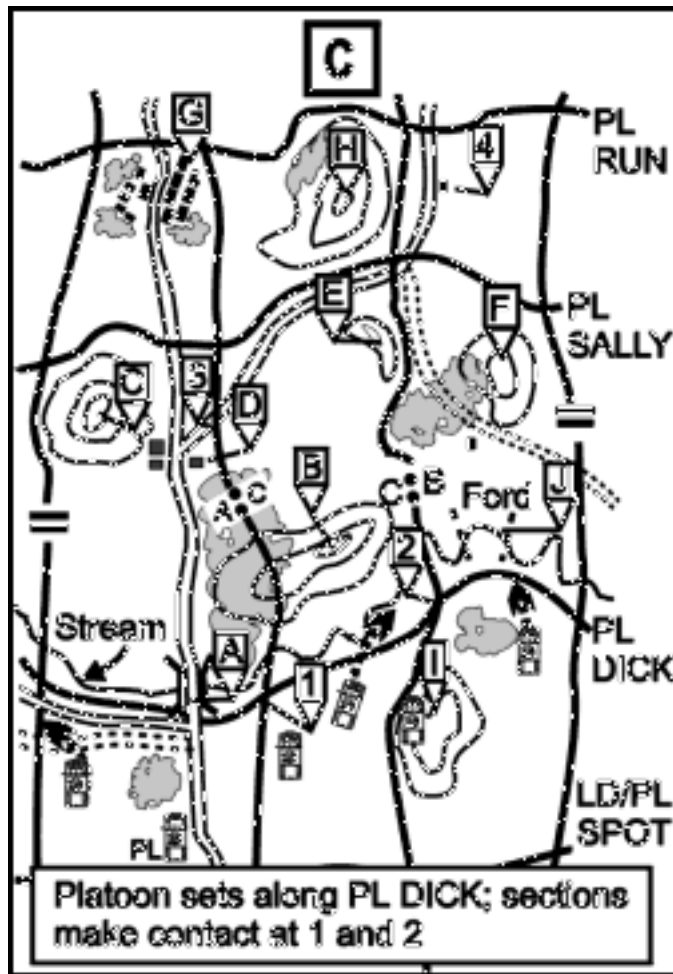

Figure 3-9C. Zone reconnaissance (continued).

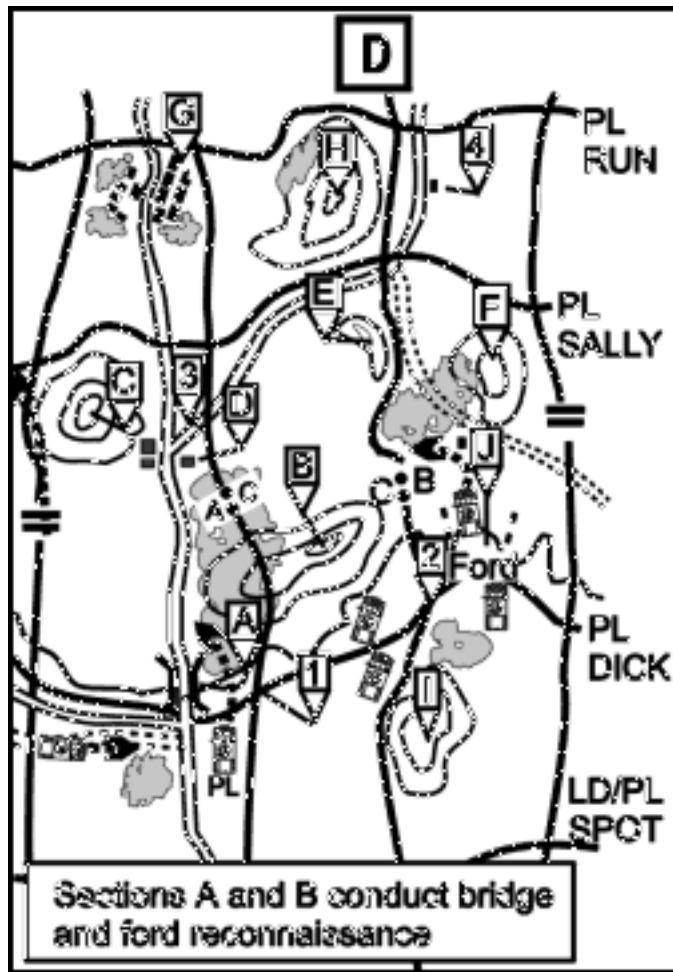

Figure 3-9D. Zone reconnaissance (continued).

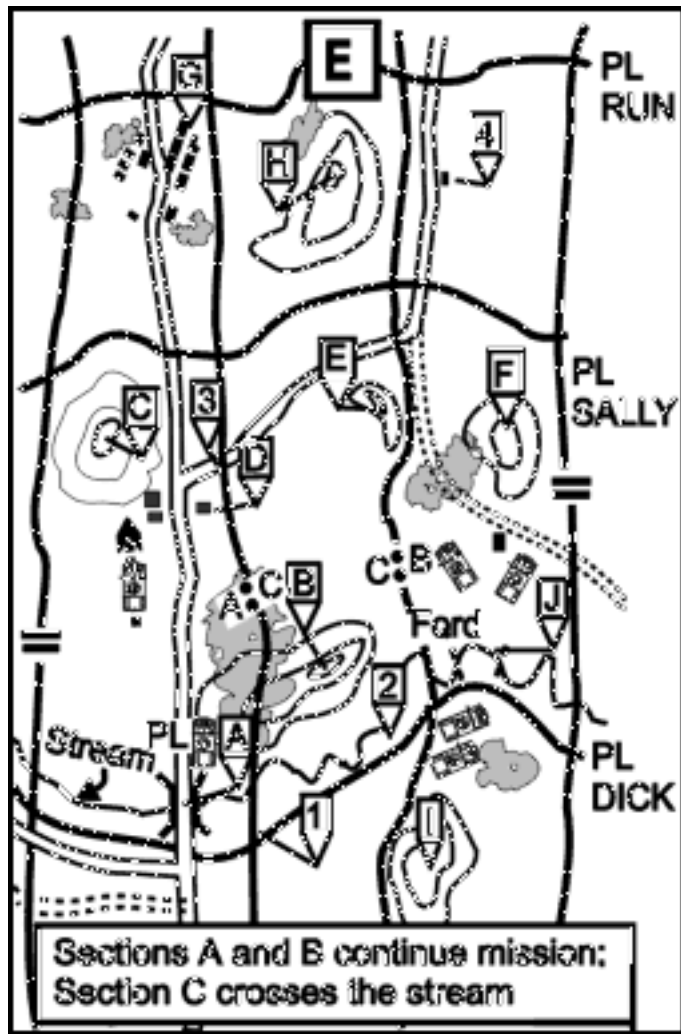

Figure 3-9E. Zone reconnaissance (continued).

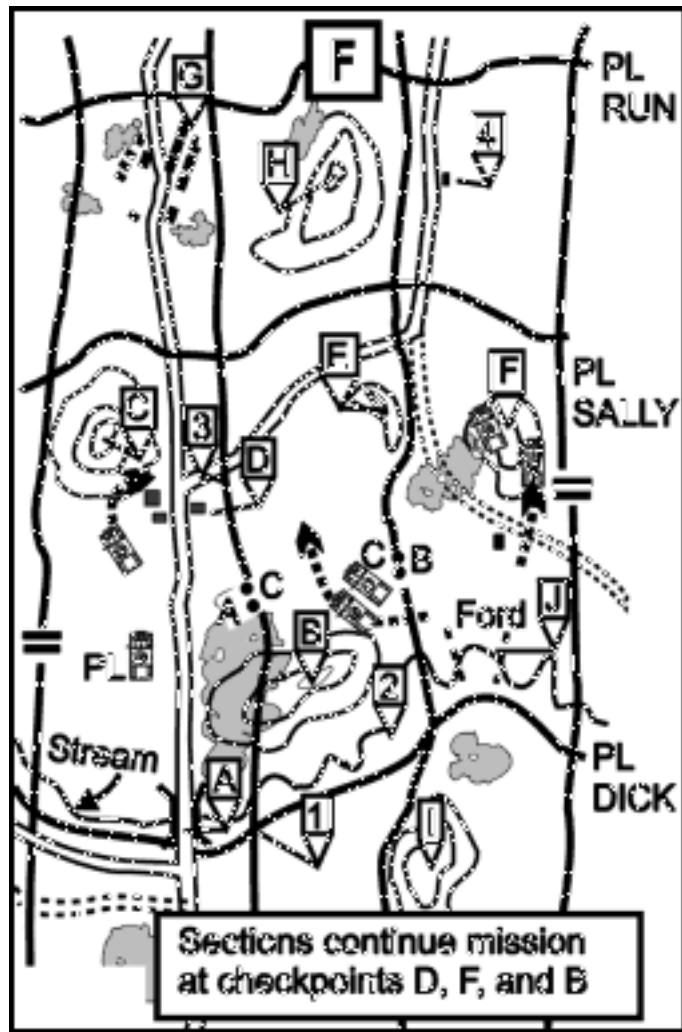

Figure 3-9F. Zone reconnaissance (continued).

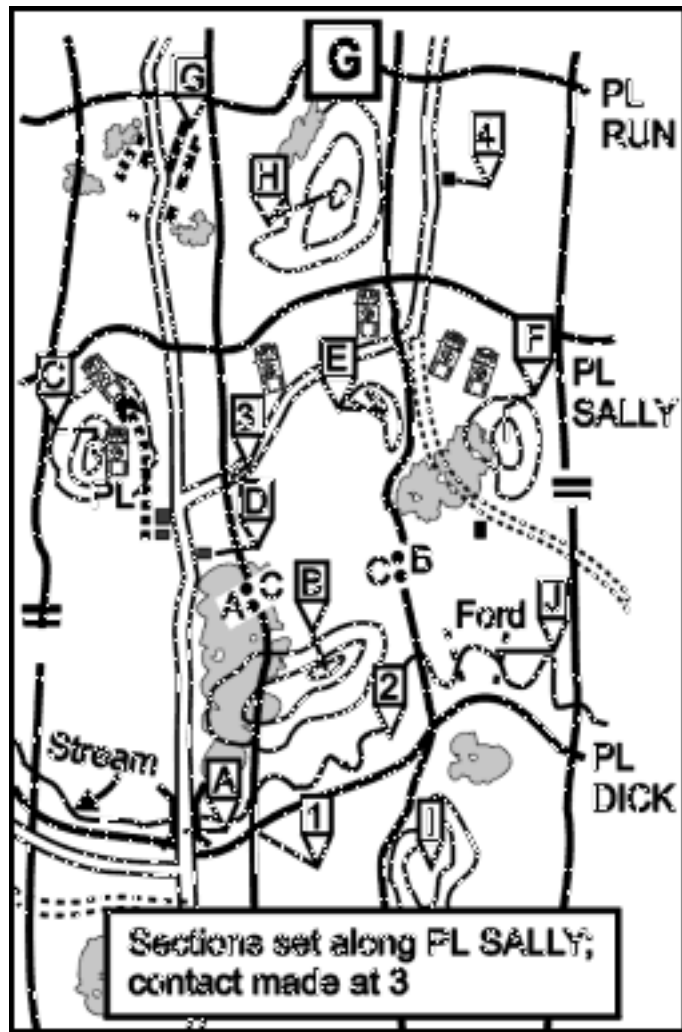

Figure 3-9G. Zone reconnaissance (continued).

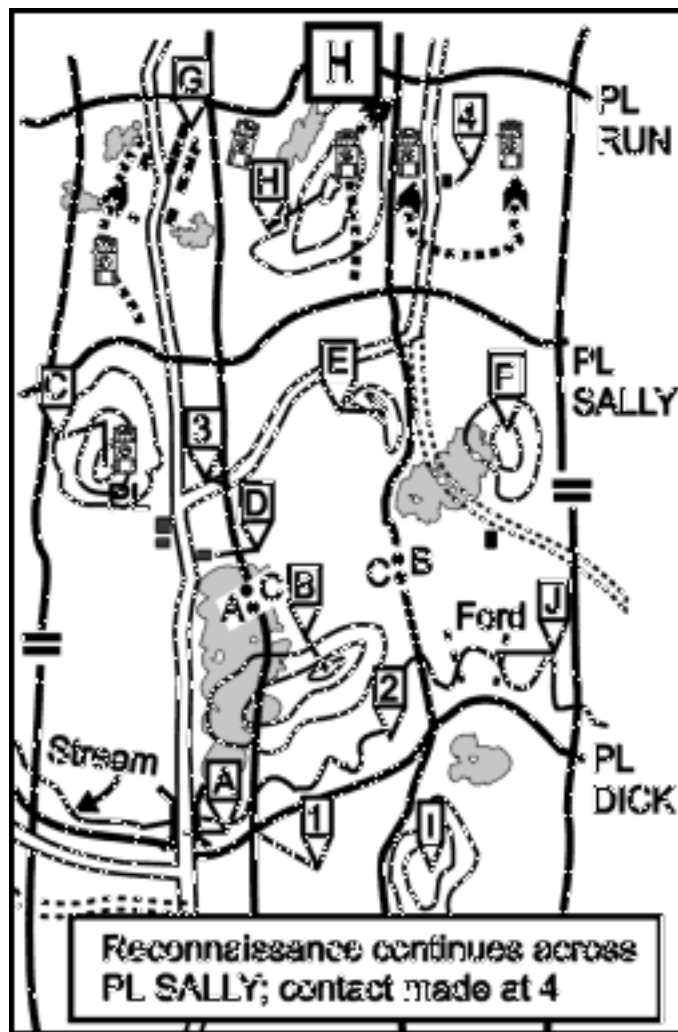

Figure 3-9H. Zone reconnaissance (continued).

Although scout platoons generally will not use strict formations forward of the FEBA, the platoon leader in this example starts out with his platoon on line. The platoon leader will attempt to generally maintain this relationship even though the sections will not be mutually supporting much of the time. The platoon should deploy into formation prior to crossing the LD, with Section A on the left, Section B on the right, and Section C in the center of the zone (see [Figure 3-9A](#)).

The platoon crosses the LD at the time prescribed in the commander's OPORD, using the bounding overwatch technique of movement within sections. In this mission, the platoon leader has chosen to position himself with Section A because of the importance of the route and bridge in Section A's area of operations. The sections maneuver through the zone in a zigzag pattern to ensure the zone is properly reconnoitered and to accomplish all critical tasks of a zone reconnaissance. Security is maintained within sections because the width and terrain of the zone prevent the sections from providing mutual support (see [Figure 3-9B](#)).

Depending on the factors of METT-TC, the platoon leader chooses the movement technique best suited for command and control. He may choose to have the sections secure the area and set at all checkpoints. As an alternative, he may have the sections bound through the checkpoints, report when they have been secured, and then set at the phase lines. If the platoon leader has not assigned sections a particular checkpoint on which to orient, the section leaders must plan their own measures to control the movement. They move section elements to contact points to ensure that the move is tied in with that of

the other sections. The platoon leader does not allow any element to cross PL DICK until all elements have reported set (see [Figure 3-9C](#)).

When the platoon is set on PL DICK, the leader gives the sections permission to execute DICK and move to PL SALLY. The sections immediately begin reconnaissance of natural and man-made obstacles, including the stream to their front. Section A must execute a bridge reconnaissance and reconnoiter the stream for possible unmarked fords as well. Section C reconnoiters the stream for possible unmarked fords. Section B reconnoiters the stream for possible unmarked fords and conducts a ford reconnaissance at the known ford in the zone.

Once Section C completes its reconnaissance of the stream and reports negative results, it moves to the vicinity of contact point 2 and awaits permission to cross the stream at Section B's ford. Section C is also prepared to cross at Section A's bridge, if necessary (see [Figure 3-9D](#)).

As Sections A and B complete their reconnaissance tasks at the bridge and ford, they revert to the bounding overwatch movement technique and continue reconnaissance. Section C moves across the section boundary and prepares to cross the stream at the ford (see [Figure 3-9E](#)).

The zone reconnaissance continues with Sections A and B securing checkpoints D and F. The platoon leader holds the sections at those control measures to allow time for Section C to secure checkpoint B and get on line with the other sections at checkpoint E. This prevents dangerous gaps from developing between the sections (see [Figure 3-9F](#)).

Once Section C sets at checkpoint E, the platoon leader has all elements on line and set along PL SALLY. Sections A and C ensure that they make contact at contact point 3. The platoon leader gives permission for all elements to execute PL SALLY, then move to and set at PL RUN (see [Figure 3-9G](#)).

As the sections move across PL SALLY, Sections C and B make contact at contact point 4. The platoon uses bounding overwatch within each section as the movement technique. The sections continue the zone reconnaissance in this manner, accomplishing all critical tasks and reporting all control measures and other reconnaissance information, until they reach the LOA or reconnaissance objective (see [Figure 3-9H](#)).

SECTION 5 — AREA RECONNAISSANCE

Before moving forces into or near a specified area, commanders call on their scouts to conduct an area reconnaissance to avoid being surprised by unsuitable terrain conditions or unexpected enemy forces. The area could be a town, ridgeline, woods, or another feature that friendly forces intend to occupy, pass through, or avoid.

Area reconnaissance is frequently employed to gain information on objective areas as well as to confirm the IPB templates and provide detailed information regarding enemy dispositions. Within a zone of operations, area reconnaissance can be used to focus the scouts on the specific area that is critical to the commander. This technique of focusing the reconnaissance also permits the mission to be accomplished more quickly. Area reconnaissance can thus be a stand-alone mission or a task to a section or platoon within the larger context of a platoon or troop reconnaissance mission.

Like zone reconnaissance, area reconnaissance can be either terrain- or force-oriented. The commander analyzes the mission using METT-TC to determine whether these types of reconnaissance will be conducted separately or in conjunction with each other.

CRITICAL TASKS

Scouts must accomplish numerous critical tasks during the area reconnaissance. Their primary critical tasks include the following:

- Find and report all enemy forces within the area.
- Reconnoiter specific terrain within the area.
- Report reconnaissance information.

In addition to their primary tasks, the scouts must be prepared to conduct other tasks as directed by the higher commander. Additional tasks for the area reconnaissance include the following:

- Reconnoiter all terrain within the area.
- Inspect and classify all bridges within the area.
- Locate fords or crossing sites near all bridges in the area.
- Inspect and classify all overpasses, underpasses, and culverts.
- Within capability, locate all minefields and other obstacles in the area, reduce or breach them, and clear and mark lanes.
- Locate bypasses around built-up areas, obstacles, and contaminated areas.

TECHNIQUES

The order to conduct an area reconnaissance mission identifies the area to be reconnoitered within a continuous boundary. The platoon leader analyzes the mission, enemy, and terrain and completes his troop-leading procedures. He also plans the movement to and, if necessary, from the area, following the basic rule of using different routes to and from the area. The routes are specified for the platoon when it works as part of a larger unit, such as a cavalry troop.

The platoon's primary concern during movement to the area is security rather than reconnaissance. If the platoon leader feels there may be enemy forces along the route to the area to be reconnoitered, the platoon should employ the principles of tactical movement based on METT-TC factors. During movement to the area, it may be appropriate (depending on the commander's intent) for the platoon to avoid contact. The platoon leader may also choose to orient and focus sections or squads on checkpoints as the platoon moves to the area.

The platoon leader encloses the given area within a platoon zone; he uses boundaries, a LD, and an LOA. He can divide the area into section zones by placing boundaries on identifiable terrain; this ensures that each section has responsibility for specific pieces of terrain.

The platoon leader places contact points at the intersections of phase lines and boundaries and any other places he wants physical contact and coordination between his scout sections. He uses TIRS as necessary. He works with the FSO to plan indirect fires to support the platoon's scheme of maneuver.

The platoon can conduct area reconnaissance using any of the platoon organizations. The platoon leader deploys his sections abreast across the LD to accomplish their reconnaissance tasks. Formations are often not appropriate to the area reconnaissance mission because the area may be irregular in shape and because of the wide variety of METT-TC considerations the platoon may encounter.

EXAMPLE OF AN AREA RECONNAISSANCE

The following example of area reconnaissance is for a battalion scout platoon. [Figure 3-10](#) illustrates this situation.

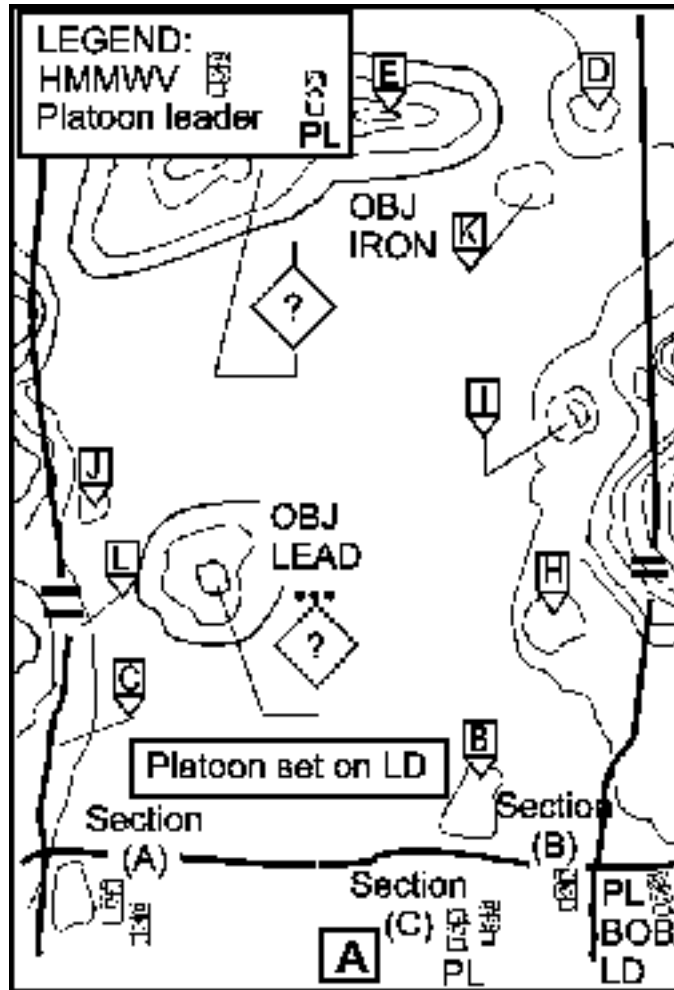

Figure 3-10A. Area reconnaissance.

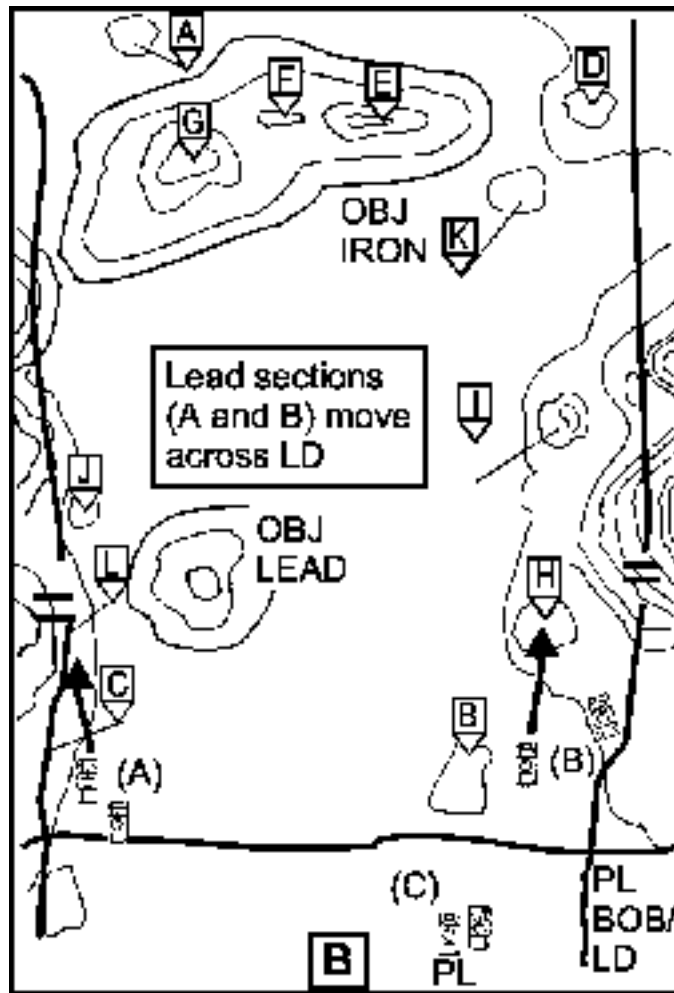

Figure 3-10B. Area reconnaissance (continued).

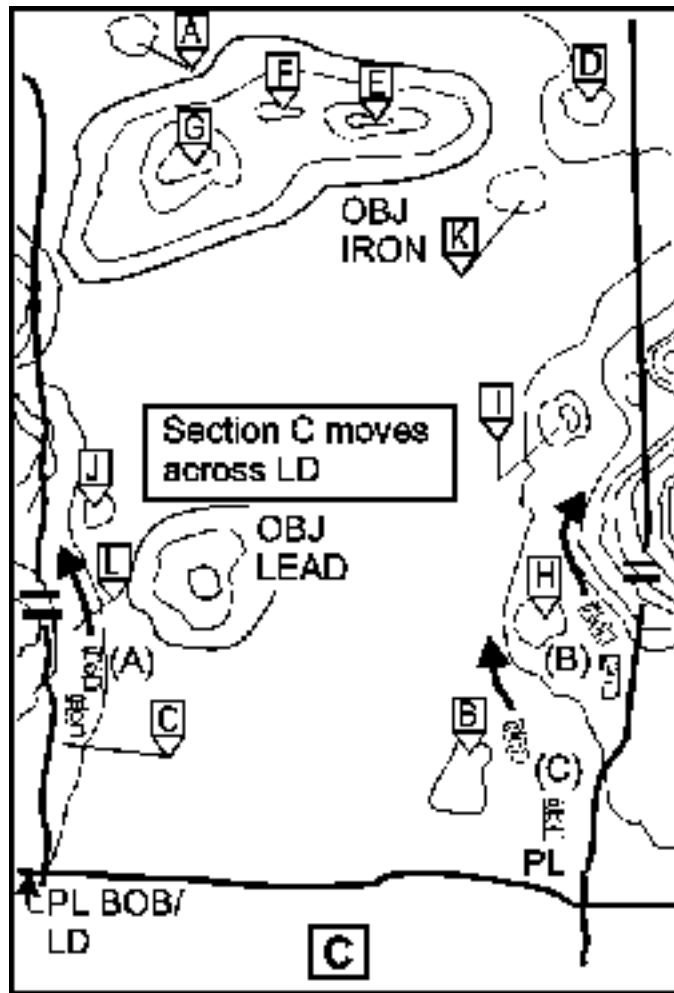

Figure 3-10C. Area reconnaissance (continued).

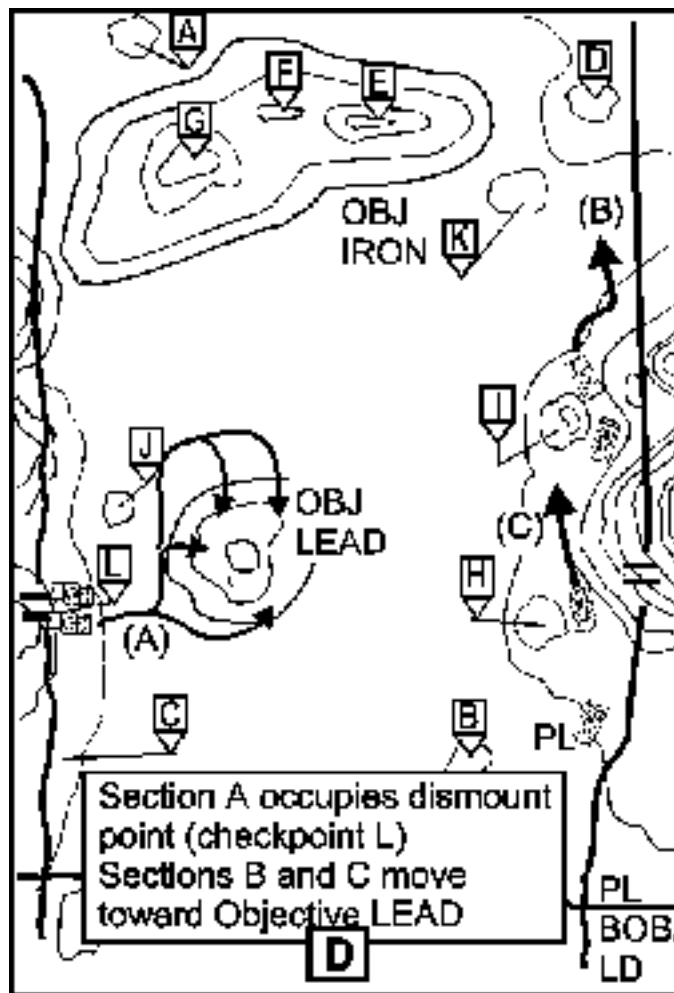

Figure 3-10D. Area reconnaissance (continued).

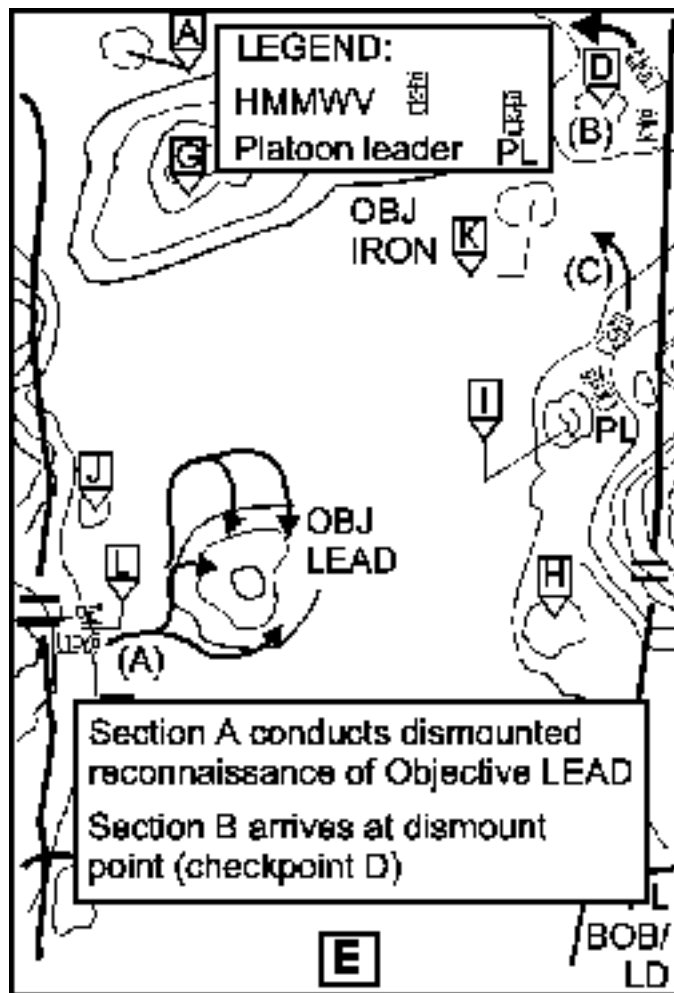

Figure 3-10E. Area reconnaissance (continued).

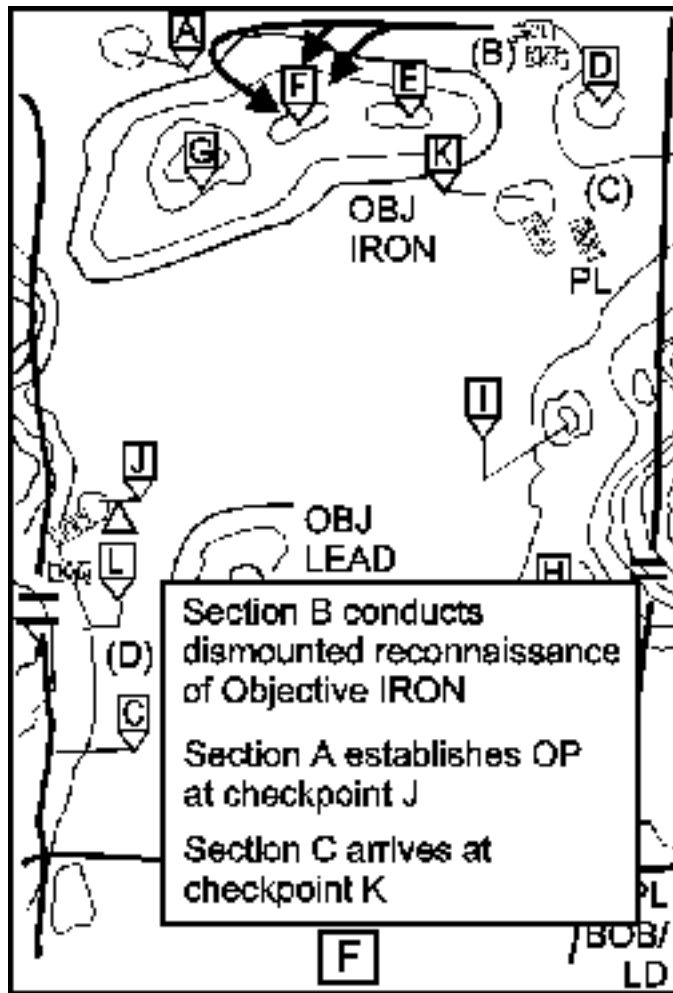

Figure 3-10F. Area reconnaissance (continued).

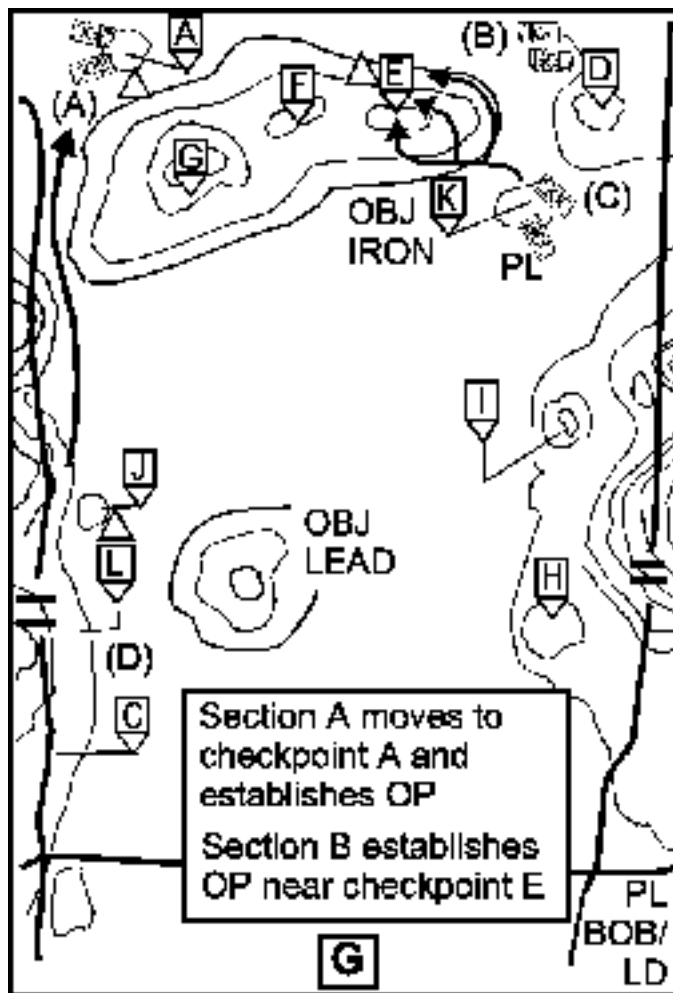

Figure 3-10G. Area reconnaissance (continued).

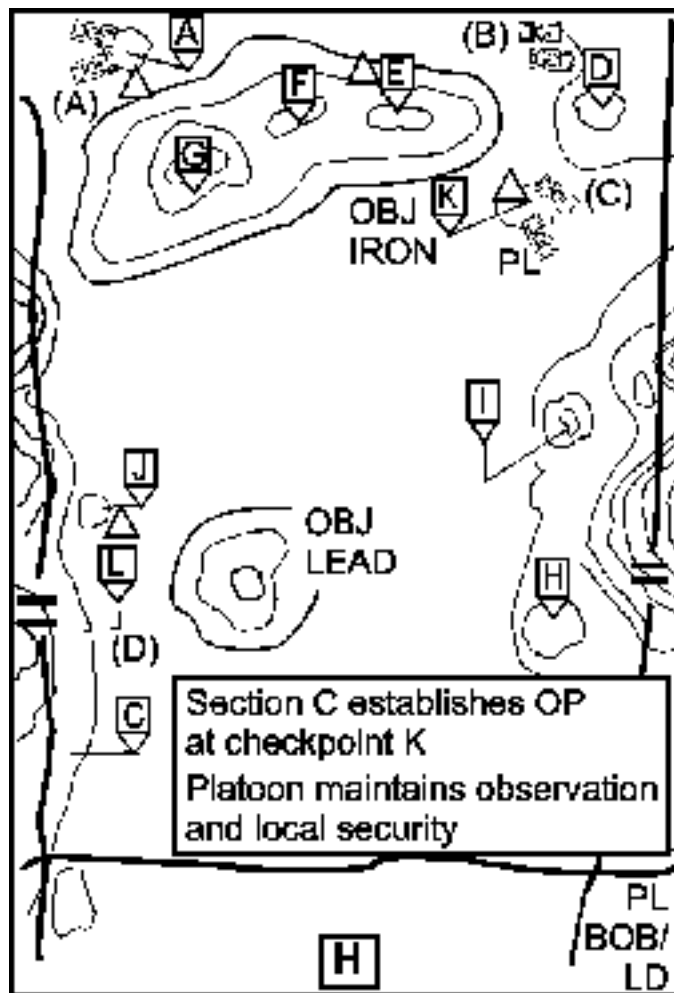

Figure 3-10H. Area reconnaissance (continued).

In this example, the battalion scout platoon has been given the mission of performing an area reconnaissance of Objective LEAD and Objective IRON. The platoon has not been assigned a specific route, and enemy dispositions are vague. The platoon leader decides, after analyzing the factors of METT-TC, to deploy his platoon to maximize security.

The platoon leader analyzes the terrain and his mission requirements and decides to use the three-section organization. He assigns Sections B and C respective checkpoints on Objective IRON. Because of Objective LEAD's smaller size, he assigns only Section A to reconnoiter it.

The platoon leader decides that he will move with Section C and thus provide close control of the reconnaissance of Objective IRON. The PSG will move with Section A to control the reconnaissance of Objective LEAD. The platoon leader decides to move the platoon using checkpoints that make maximum use of cover and concealment between the LD and the objectives (see [Figure 3-10A](#)).

Using the three-section organization, the platoon crosses PL BOB at the time specified in the commander's OPORD. The platoon crosses in sequence, with the two lead sections (A and B) executing and Section C waiting until initial checkpoints are secured before proceeding. No platoon formation is used. The lead sections, which have the longest distance to move to their reconnaissance objectives, use bounding overwatch to ensure maximum security (see [Figure 3-10B](#)).

As the lead sections execute Checkpoints C and H, Section C crosses the LD. The movement technique

is bounding overwatch within sections (see [Figure 3-10C](#)).

The scout sections continue their move to the designated dismount points. Section A occupies its dismount point, Checkpoint L. The section sets its vehicles in hide positions, organizes a patrol, and deploys local security (see [Figure 3-10D](#)).

Section A's patrol moves on covered and concealed dismounted routes to Objective LEAD and conducts a dismounted reconnaissance. The patrol uses the fan dismounted reconnaissance technique to thoroughly reconnoiter the objective. Section B occupies its dismount point (Checkpoint D), while Section C continues to move (see [Figure 3-10E](#)).

Section A's patrol completes its reconnaissance of Objective LEAD. The section submits its report and establishes an OP in the vicinity of checkpoint J from which it can observe the objective area. Section B dispatches a patrol to conduct dismounted reconnaissance on Objective IRON. The platoon leader has designated checkpoints on the objective to focus the patrol, which concentrates on the terrain around checkpoint F. Section C occupies its dismount point in the vicinity of checkpoint K (see [Figure 3-10F](#)).

Section B completes the reconnaissance of Objective IRON; it then establishes an OP near checkpoint E from which it can observe the objective area and monitor any changes in the enemy situation. The section also submits its reports on enemy dispositions through the platoon leader to the commander. Section C conducts a dismounted patrol to reconnoiter the area around checkpoint E, its portion of Objective IRON. Section A moves to checkpoint A, where it establishes an OP to observe its portion of Objective IRON (see [Figure 3-10G](#)).

Section C completes its reconnaissance of Objective IRON, submits detailed reports to the platoon leader and commander as necessary, and establishes an OP at checkpoint K. All sections reconnoiter the objective area from their OPs and send updated spot reports as necessary. The platoon continues to observe the objective until relieved or assigned subsequent tasks by its higher headquarters (see [Figure 3-10H](#)).

SECTION 6 — OBSTACLE/RESTRICTION RECONNAISSANCE

One of the common tasks associated with reconnaissance missions is location and reconnaissance of obstacles and restrictions that may affect the trafficability of a particular route or axis. Obstacles and restrictions can be either natural or man-made. Current threat doctrine emphasizes the use of man-made obstacles to reinforce natural obstacles and of restrictions to slow, impede, and canalize friendly forces. These obstacles and restrictions include the following:

- Minefields.
- Bridges.
- Log obstacles such as abatisses, log cribs, stumps, and posts.
- AT ditches.
- Wire entanglements.
- Defiles.
- Persistent agent contamination.

The scout platoon's ability to deal with an obstacle or restriction is extensive in certain areas and, at the same time, somewhat limited in others. The scouts' most important function is reconnaissance of deliberate obstacles, including supporting enemy positions and possible breach sites. Another important reconnaissance task for the scouts is to locate bypasses around obstacles and restrictions. Engineer reconnaissance teams may be task organized to the scout platoon to assist in obstacle reconnaissance.

The scout platoon has the capability to reduce or breach small obstacles; however, this is generally limited to point obstacles that are not integrated into the enemy defense and are not covered by enemy fire and observation. When the scouts encounter obstacles that support an enemy defense, they have the capability to assist in breaching.

NOTE: An engineer squad is often attached to the scout platoon to assist in obstacle/restriction reconnaissance. This squad provides expertise in collecting OBSTINTEL; it also provides extremely limited breaching capability.

THE STEPS OF OBSTACLE/RESTRICTION RECONNAISSANCE

How the scout approaches obstacle and restriction reconnaissance is highly dependent on METT-TC factors. In general, however, the process of conducting this type of reconnaissance can be covered in five steps that under most METT-TC conditions will ensure an organized and efficient operation:

- Detection.
- Area security and reconnaissance.
- Obstacle reconnaissance.
- Selection of a COA.
- Recommendation/execution of a COA.

Detection

During reconnaissance operations, scouts must locate and evaluate man-made and natural obstacles and restrictions to support the movement of their parent unit. Detection of obstacles and restrictions begins in the planning phase of an operation when the S2 conducts IPB. The scouts combine the S2's work with the reconnaissance conducted during the troop-leading process (normally a map reconnaissance only) to identify all possible obstacles and restrictions within their area of operations. The scouts then plan their reconnaissance based on the orders they receive, the S2's IPB, and their own map reconnaissance.

The scouts use visual and physical means to detect mines and obstacles while conducting their mission. They visually inspect terrain for signs of mine emplacement and other reinforcing obstacles. They also must be alert to dangerous battlefield debris such as bomblets from cluster bomb units (CBU) or dual-purpose improved conventional munitions (DPICM).

Mines and other types of obstacles can be difficult for mounted elements to detect; therefore, scouts must also conduct obstacle detection while dismounted. They may need to dismount their vehicles several hundred meters short of a suspected obstacle and approach the obstacle on foot to conduct reconnaissance. They look for disturbed earth, unusual or out-of-place features, surface-laid mines, tilt rods, and tripwires. They can incorporate vehicle-mounted thermal sights into the search to help detect surface-laid mines.

Physical detection methods include detonating, probing, and using a mine detector. Detection occurs when a vehicle, soldier, or countermine system physically encounters a mine. This method does not indicate the boundaries of the obstacle. The scouts must probe or conduct additional visual inspection to define the extent of the minefield.

Area security and reconnaissance

Enemy forces often cover their obstacles with observation and fire. Whenever scouts encounter an obstacle, they must proceed with their reconnaissance assuming the enemy can observe and engage them. The scout element that detects the obstacle establishes overwatch before it proceeds with the reconnaissance. The scouts in overwatch look for signs of enemy forces in and around the obstacle or in positions that allow observation of the obstacle. They visually search the dominant terrain on the far side of the obstacle for evidence of enemy positions or ambushes.

Once they confirm the enemy situation from the near side, the scouts not in overwatch move mounted and/or dismounted to find bypasses around the obstacle. If they find a bypass, they move around the obstacle and establish OPs on the far side to provide 360-degree security of the obstacle. If the scouts are unable to find a bypass, they must conduct their reconnaissance from the near side under the security of the overwatch elements.

Obstacle reconnaissance

Once security is established, scouts then move dismounted to the obstacle. The scouts must be cautious when reconnoitering the obstacle. Tripwires or other signs may indicate the enemy is using booby traps or command-detonated mines to prevent friendly forces from determining pertinent information about the obstacle, known as OBSTINTEL. The scout platoon must collect all information that may be critical to the commander in such areas as planning a breach and verifying the enemy template. Examples of OBSTINTEL include:

- Obstacle location.
- Obstacle orientation.
- Soil conditions.
- Presence of wire, gaps, and bypasses.
- Composition of complex obstacles.
- Minefield composition, including types of mines.
- Breaching requirements.
- Gaps between successive obstacle belts.
- Location of enemy direct fire weapons.

The scout element reconnoitering the obstacle prepares an obstacle report with this information and forwards the report through the platoon leader or PSG to the commander.

Choosing a course of action

The scout platoon leader analyzes the situation and the factors of METT-TC to determine what COA to select. He has a choice of four COAs:

- Bypass the obstacle/restriction.

- Conduct obstacle reduction.
- Support a breaching operation.
- Continue the mission.

Bypass. A bypass is the preferred method when it offers a quick, easy, and tactically sound means of avoiding the obstacle. A good bypass must allow the entire force to avoid the primary obstacle without risking further exposure to enemy ambush and without diverting the force from its objective. Bypassing conserves reduction assets and maintains the momentum of the moving unit. If the platoon leader decides to bypass and his commander approves, the scouts must mark the bypass and report it to the commander. They may be required to provide guides for the main body if the bypass is difficult to locate or visibility conditions are poor.

NOTE: In some cases, bypassing is not possible, with breaching the best, or only, tactical solution. Such situations may include the following:

- The obstacle is integrated into a prepared defensive position and the only available bypass canalizes friendly forces into a fire sack or ambush.
- The scout platoon mission specifically tasks the platoon to reconnoiter and reduce any obstacle or to eliminate any enemy forces located on the original route, allowing follow-on forces to maintain freedom of movement.
- The best available bypass route will not allow follow-on forces to maintain their desired rate of movement.
- Improving the bypass may require more time and assets than breaching the primary obstacle(s).

Conduct obstacle reduction. Obstacle reduction significantly degrades the platoon's ability to maintain momentum either, for its own reconnaissance effort or for follow-on forces. Obstacles within the scouts' breaching capability include small minefields, simple wire obstacles, small roadblocks, craters, and similar point-type obstacles. For other types of obstacles, the scouts can support the breaching effort.

Support a breaching operation. When the scout platoon locates a large obstacle that cannot be easily bypassed, its primary option is to support a breaching operation. The scouts perform additional reconnaissance and security tasks as necessary; these may include determining the amount of time and resources required to reduce the obstacle and locating the best available reduction site. (**NOTE:** If he expects to encounter large obstacles during an operation, the commander may direct engineer reconnaissance teams to move with the scouts to determine much of this information.) The scout reconnaissance effort focuses on the following features:

- Fighting positions for support force weapons on the near side of the obstacle.
- Trafficable routes to the reduction site and routes from the far side leading to the objective.
- Dispersed covered and concealed areas near the reduction site.
- Work areas on the near side for reduction assets of the breach force.
- Fighting positions on the far side once a foothold is established.
- Positions on both sides of the obstacle that could facilitate enemy observation of the reduction site.
- Trafficability and soil conditions near the reduction site. This is especially important for minefield reduction because mine-clearing blades will not work properly in all soil conditions.

- Width, depth, and bottom condition of wet and dry gaps.
- Bank height and slope, soil stability of wet and dry gaps.
- Water velocity of wet gaps.
- Wind direction for obscuration of the obstacle.

Gathering the OBSTINTEL necessary for a breaching operation can be made much easier if engineers work closely with the scouts. If he expects to encounter large obstacles during a mission, the scout platoon leader should request an attached engineer reconnaissance team or, as a minimum, an engineer NCO to serve as a technical advisor.

After the scouts report the necessary information to the commander, they maintain security of the obstacle and serve as guides, if necessary, for the breach force. The information they provide is used by the commander and his engineers to prepare the suppression, obscuration, security, and reduction (SOSR) plans for the breach. The scouts maintain security during the breaching operation and call for and adjust indirect fires, as necessary, in support of the breaching operation. The scouts must be in position to move rapidly through the obstacle once a lane is created so they can continue their mission.

Continue the mission. When the scouts encounter a restriction, such as a bridge or defile, they may find that the restriction is not an obstacle to movement and is not covered by enemy fire or observation. Scouts may also discover dummy minefields or obstacles that are incomplete and easily passed through. Under these conditions, the scouts' COA may be to report, then continue their reconnaissance mission.

Recommending/executing a course of action

Once the scout has determined the COA best suited to the situation, he either executes it or recommends it to his higher headquarters for approval. Generally, the scout will execute a particular COA without specific approval if it was addressed in the OPORD he received from higher or is covered in his unit SOP. In such a case, the scout will execute the COA and then inform the commander of his actions. If the situation the scout discovered is not covered by previous guidance, he determines the best COA and recommends it to his commander. He then executes the COA specified by the commander.

EXAMPLES OF OBSTACLE/RESTRICTION RECONNAISSANCE

These examples illustrate reconnaissance of obstacles and restrictions in two tactical situations. They are organized using the five-step process.

Reconnaissance of a restriction (not covered by fire or observation)

[Figure 3-11](#) illustrates this situation.

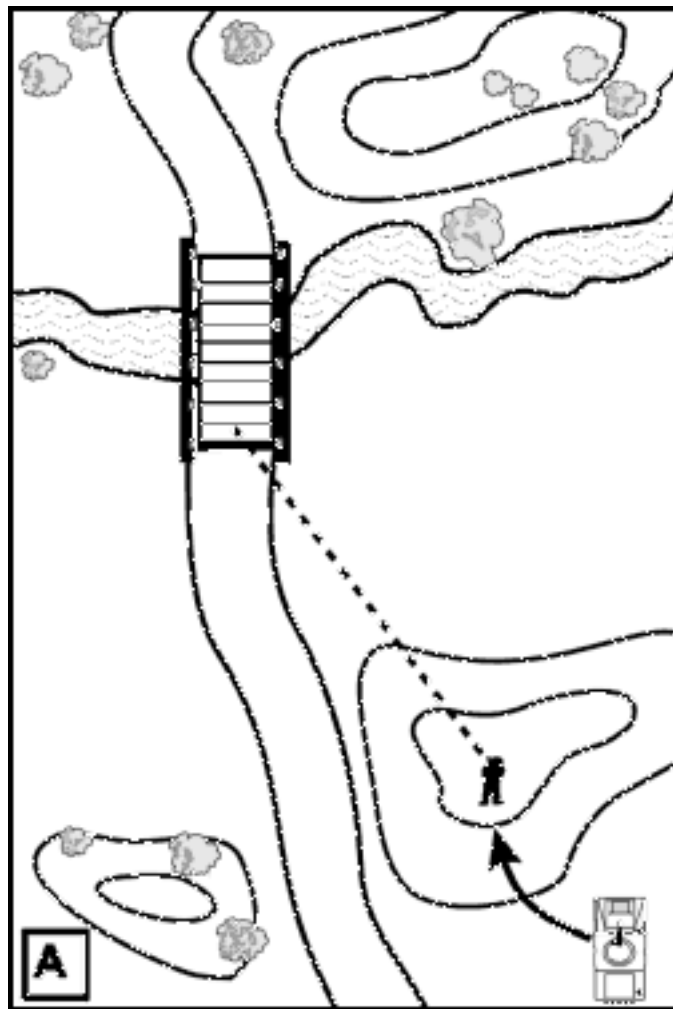

Figure 3-11A. Reconnaissance of a restriction.

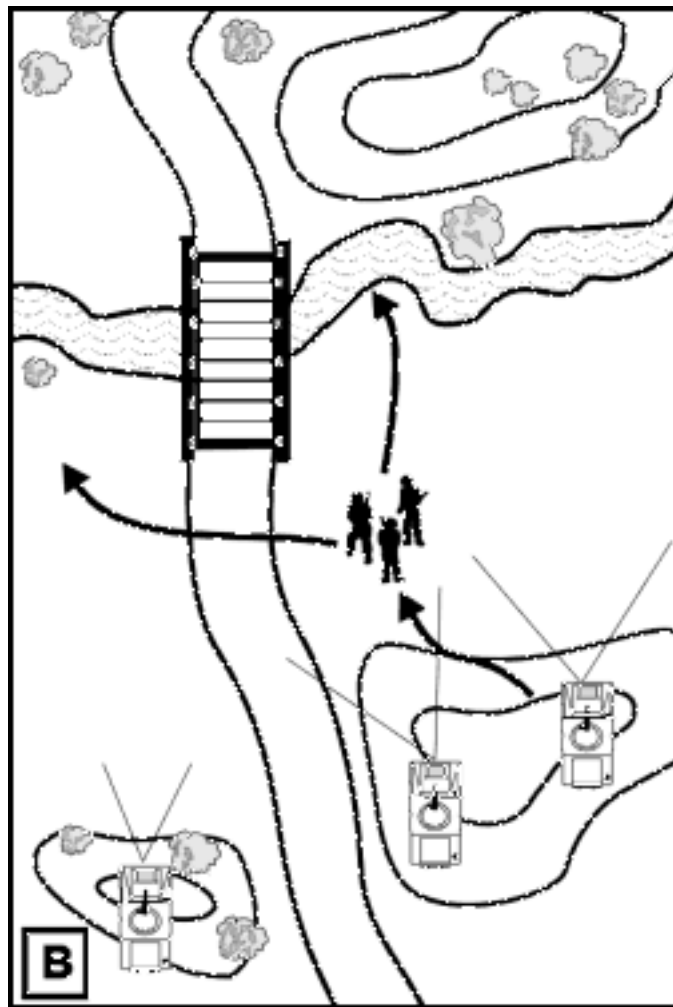

Figure 3-11B. Reconnaissance of a restriction (continued).

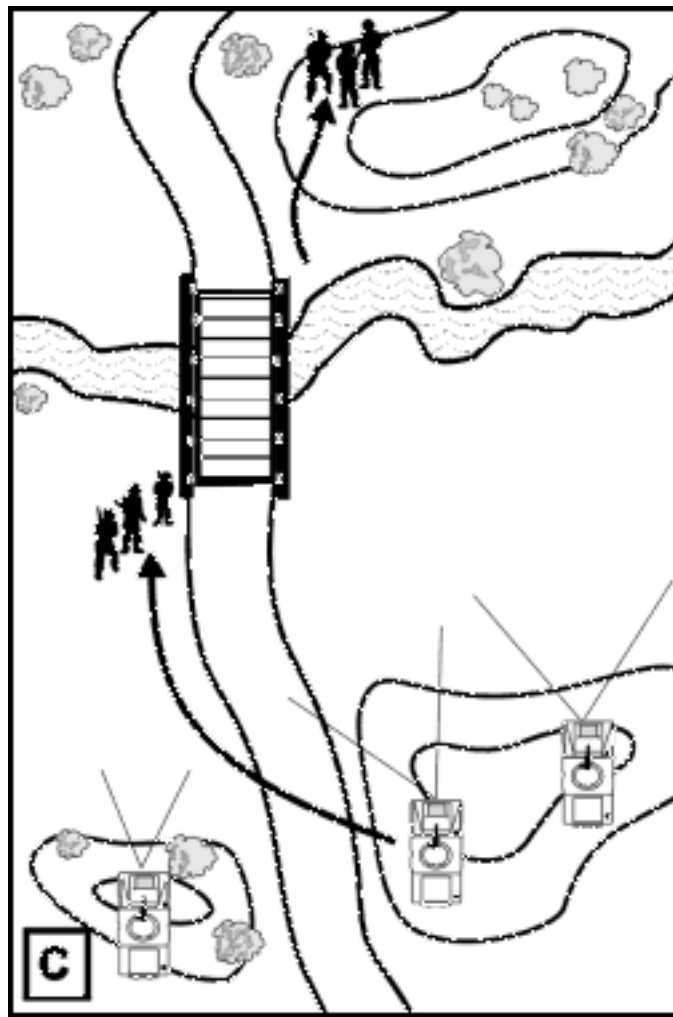

Figure 3-11C. Reconnaissance of a restriction (continued).

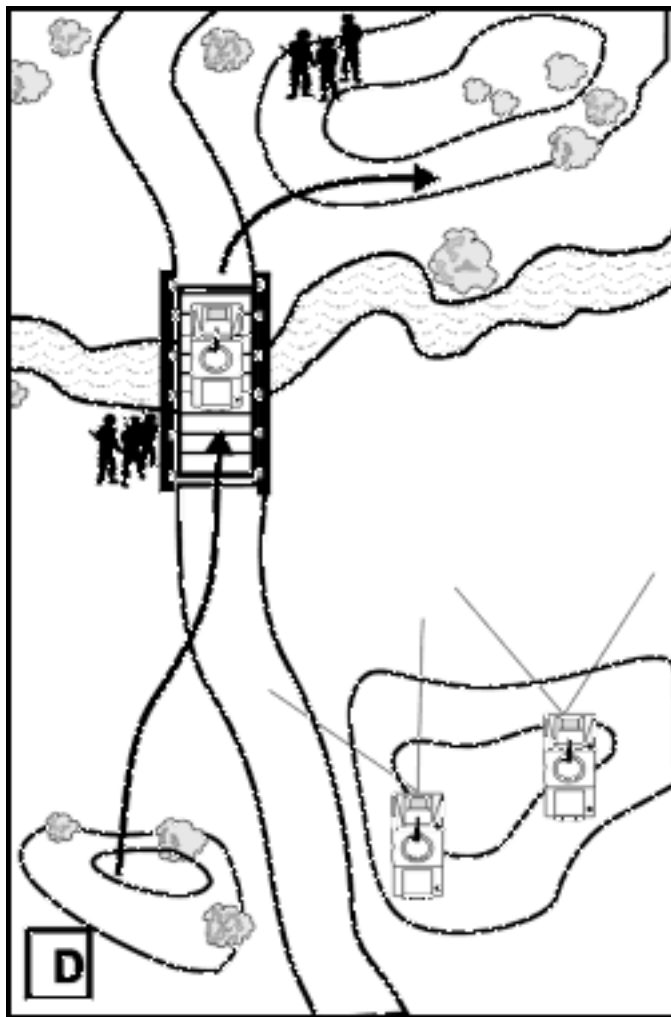

Figure 3-11D. Reconnaissance of a restriction (continued).

Detection. A scout section detects a bridge when a dismounted element observes it from an overwatch position (see [Figure 3-11A](#)). The bridge was expected because it was also identified during the scout's map reconnaissance. The dismounted scouts confirm the bridge's location and report that it appears to be intact.

Area security and reconnaissance. The dismounted scouts bring the section's vehicles into covered and concealed overwatch positions; the section establishes near-side security of the bridge. A dismounted patrol is organized to conduct reconnaissance up to the bridge, overwatched by the vehicles (see [Figure 3-11B](#)). The dismounted element reconnoiters for both mounted and dismounted bypasses. The dismounts must determine quickly if it is possible to bypass the bridge through the use of a ford in the local area. The platoon leader monitors the situation and, if necessary, may direct other sections to assume the mission of locating other bridges or fords to serve as bypasses.

If the water obstacle can be forded, the dismounts use the ford to move to the far side. On the far side, they reconnoiter the terrain that dominates the bridge. They establish far-side security on terrain where they can observe enemy approach routes to the bridge. Once the far side is secure, the section is ready to reconnoiter the bridge itself.

If the water obstacle cannot be easily forded in the local area, the scouts may have to cross on the bridge itself. Before attempting to cross, the dismounted scouts visually examine the bridge for structural

damage and rigged explosives. Because the bridge appears intact, the dismantled element then crosses the bridge one scout at a time. The scouts move quickly to the far side and take up covered and concealed positions that provide local security on the opposite approach to the bridge. Once the entire dismantled element is secure on the opposite side, it continues beyond the immediate bank area to secure the far side.

Obstacle reconnaissance. Once the area has been reconnoitered and secured, a dismantled element moves to the bridge under the supervision of the senior scout and conducts a detailed examination of the bridge (see [Figure 3-11C](#)). The scouts examine the bridge for the following purposes:

- Ensure that the bridge is free of demolitions. This requires examination of underwater pilings and the underside of the bridge for hidden explosives. In addition, the scouts should take a detailed look at the far side to find any electrical cables or wires connecting the bridge to the shore.
- Find any structural damage. The scouts look for obvious signs of enemy destruction efforts as well as for less obvious signs of structural damage, including cracks or fractures in stringers or supports and twisted or untrue alignments of stringers or supports.
- Conduct a hasty classification of the bridge. The scouts determine if it will support the largest vehicle in the unit.

The section leader consolidates all appropriate and relevant reports (for example, the bridge, ford, and bypass reports) and sends them higher.

Choosing a course of action. Based on the results of the bridge reconnaissance, the section leader determines that the restriction is secure, that he can safely move the section across it, and that he can continue his mission.

Recommending/executing a course of action. In accordance with the platoon SOP, the scout section leader now moves the remainder of his element across the bridge. The lead scout vehicle moves across the bridge, overwatched by the other vehicles (see [Figure 3-11D](#)). The vehicle crosses with only the driver on board. As he observes the crossing, the section leader watches for any signs of damage or stress on the bridge.

Once the lead vehicle is across, it moves to link up with the dismantled element and assists in providing far-side security. At this point, the overwatch vehicles can cross the bridge, and the section can continue its mission. The section leader also advises his platoon leader that he is continuing his mission.

Reconnaissance of a deliberate obstacle (covered by fire)

[Figure 3-12](#) illustrates this situation.

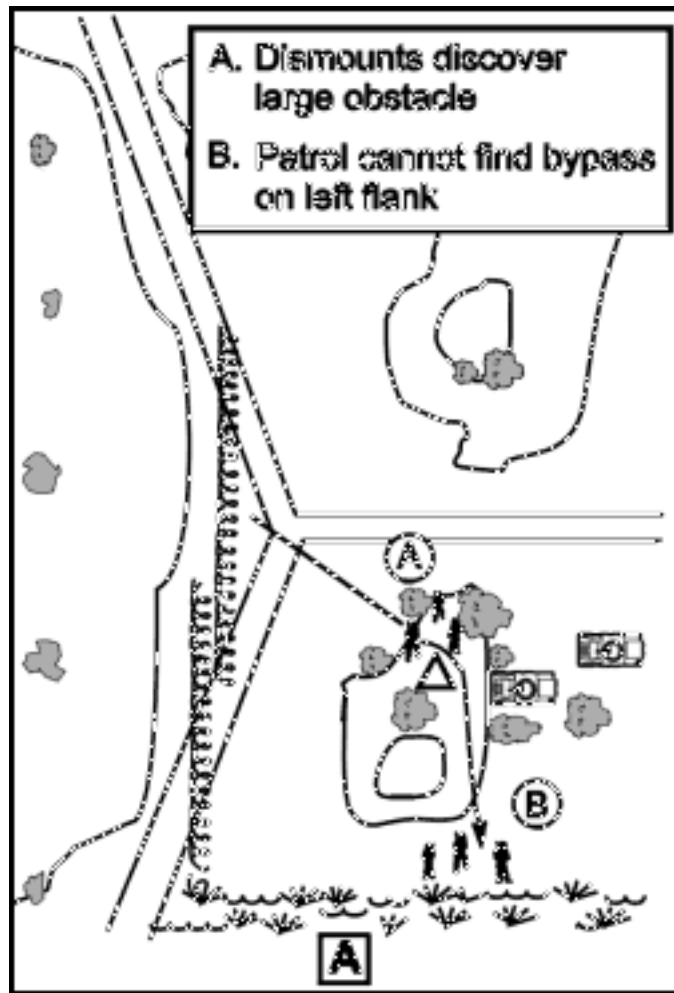

Figure 3-12A. Reconnaissance of an obstacle.

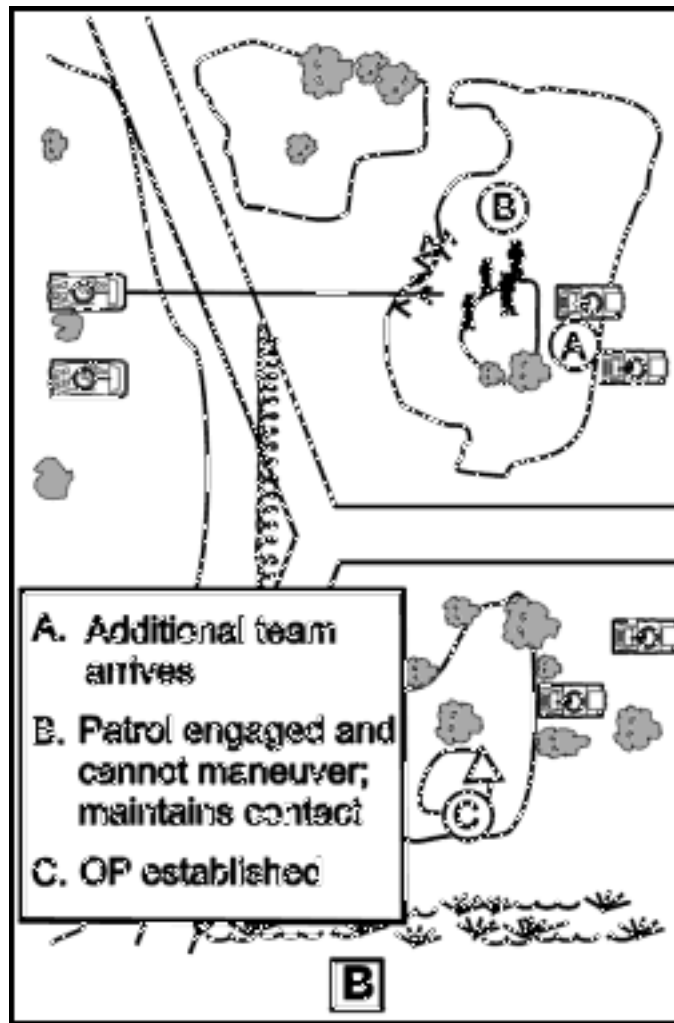

Figure 3-12B. Reconnaissance of an obstacle (continued).

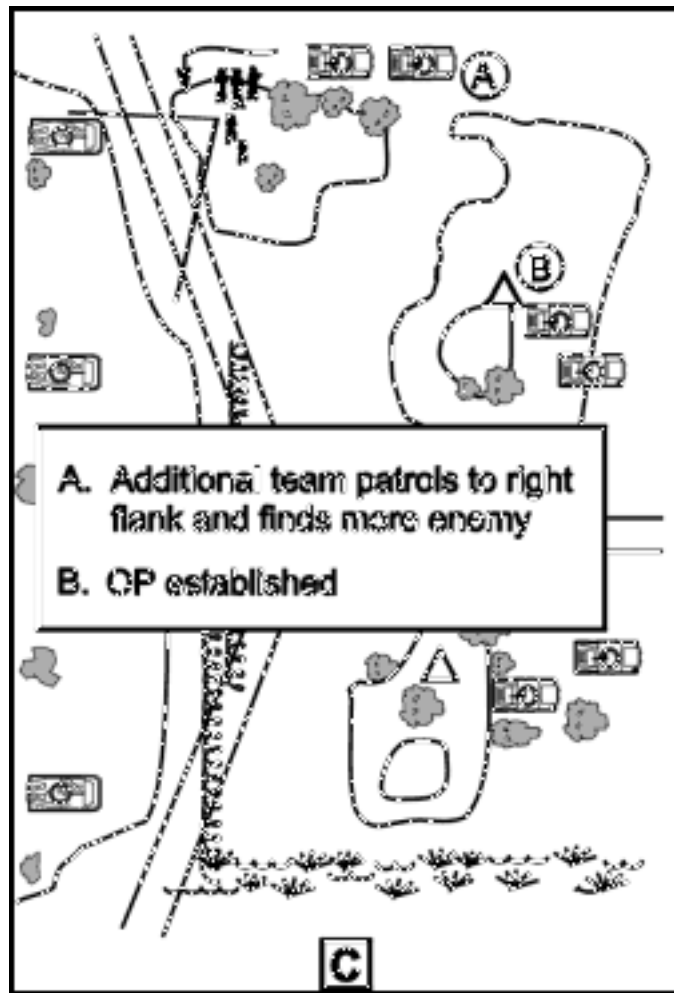

Figure 3-12C. Reconnaissance of an obstacle (continued).

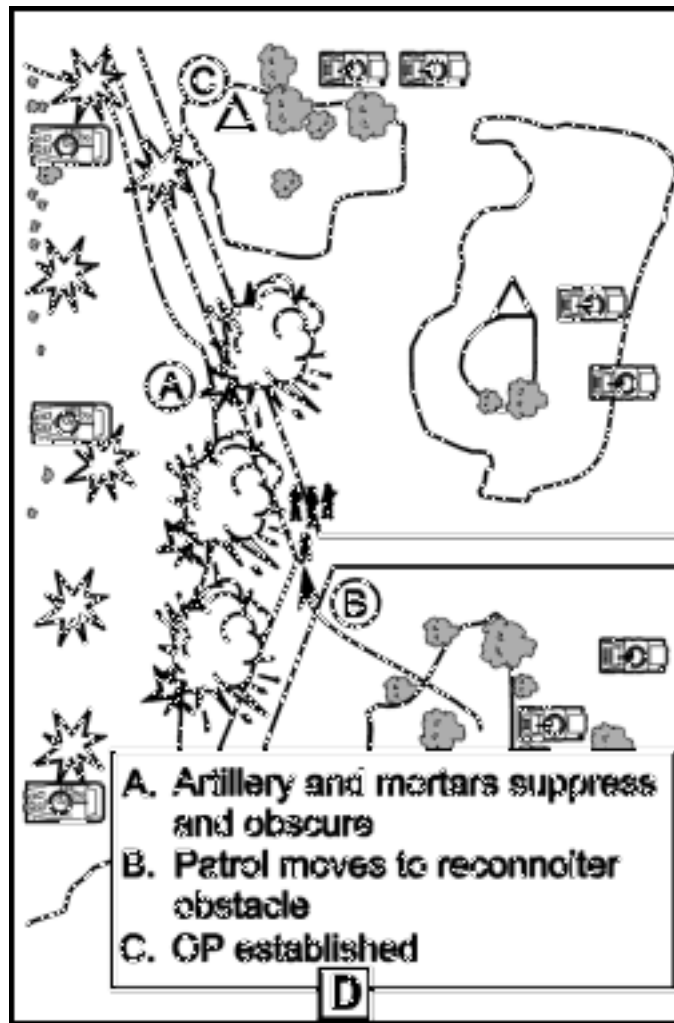

Figure 3-12D. Reconnaissance of an obstacle (continued).

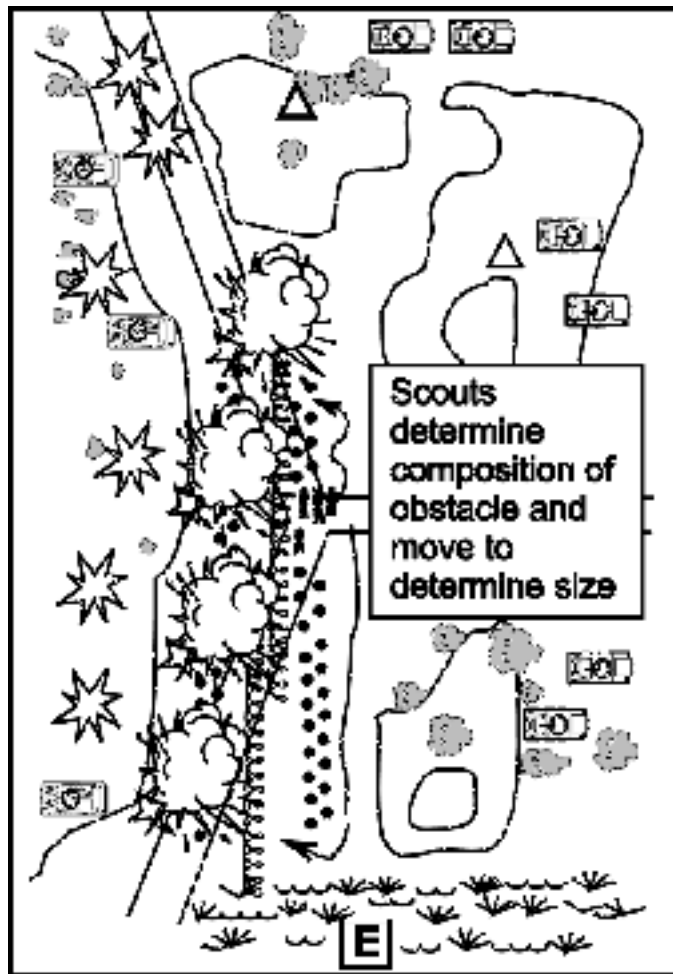

Figure 3-12E. Reconnaissance of an obstacle (continued).

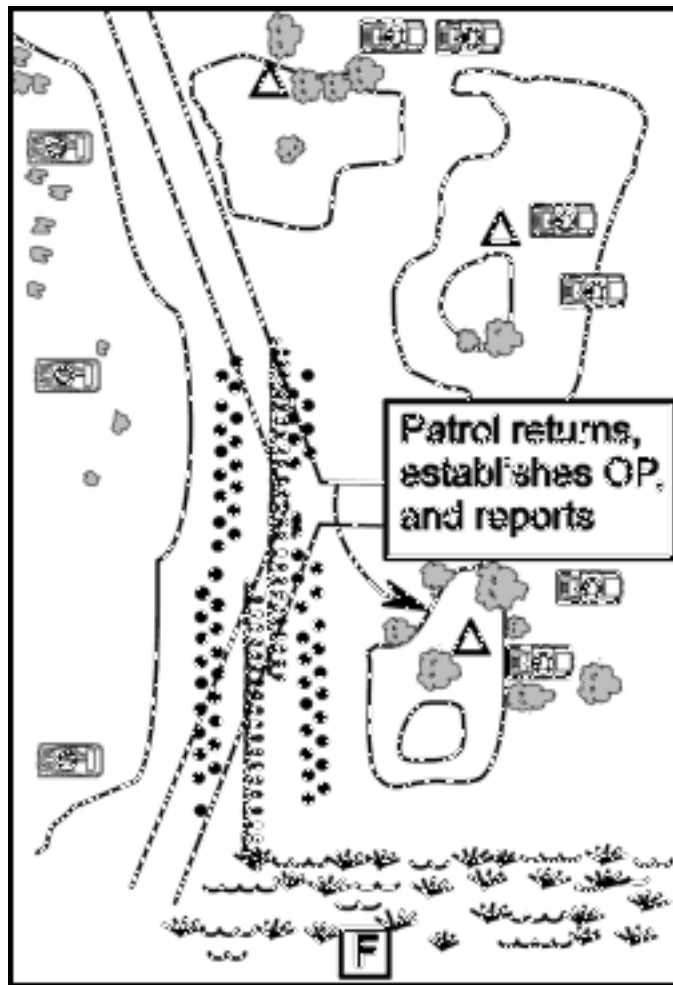

Figure 3-12F. Reconnaissance of an obstacle (continued).

Detection. Dismounted scouts detect an extensive wire obstacle from a covered and concealed position. From its vantage point, the scout section cannot determine any additional details.

Area security and reconnaissance. The scout section brings vehicles up to covered and concealed positions to overwatch the obstacle. It organizes a dismounted element to attempt to locate a bypass and secure the far side. Because of the obstacle's size, the section also informs the platoon leader that it will take considerable time for the section to reconnoiter the obstacle by itself. In the process of executing the patrol, the section discovers that the left flank of the obstacle is tied into an impassable swamp (see [Figure 3-12A](#)).

Based on this initial evaluation, the platoon leader attempts to increase the speed of the reconnaissance by sending two additional sections to find a bypass around the right flank of the obstacle. One section moves to a dismount point and sends a patrol around the right flank. The patrol is engaged by enemy machine guns. The overwatch vehicles suppress the machine guns and then are engaged by enemy vehicles in defensive positions. The section reports that it can maintain contact with the enemy but can no longer maneuver (see [Figure 3-12B](#)). The other section, positioned where it can observe the enemy from the rear, reports a company-size unit in defensive positions overwatching the obstacle. It also reports that there are no trafficable routes around the enemy's right flank (see [Figure 3-12C](#)).

At this point, the platoon leader determines that he does not have the combat power to secure the far side of the objective. He also determines that the only trafficable bypass is covered by enemy direct fires. He

now must conduct a detailed reconnaissance of the obstacle before he can recommend a COA to his commander.

Obstacle reconnaissance. The scout section that originally detected the obstacle is in the best position to reconnoiter it. It organizes a dismounted element to move to the obstacle. Because there is enough light for the enemy to visually cover the obstacle, the platoon leader coordinates indirect fire to support the patrol. As the patrol moves out, mortars lay suppressive fires on the known enemy positions, and artillery fires smoke into the area between the enemy positions and the obstacle (see [Figure 3-12D](#)).

The scouts move by covered and concealed dismounted routes to the obstacle; through probing and visual observation, they determine that the wire obstacle is reinforced with buried mines. They are able to determine that there is a mix of AT and AP mines with antihandling devices, emplaced in 30-meter belts on both the near side and the far side of the wire. Once they acquire this information, the scouts move laterally along the obstacle to determine its length and to find out if its composition is uniform. They look for the most favorable breaching location (see [Figure 3-12E](#)).

Choosing a course of action. The platoon leader evaluates the situation and determines that he cannot bypass the obstacle and does not have the capability to breach it. He decides to recommend a deliberate breach.

Recommending/executing a course of action. The platoon leader recommends to his commander that the platoon prepare to support a deliberate breach. With higher approval, he orders the platoon to continue the reconnaissance and security tasks necessary to support a deliberate breach operation. He also begins coordinating with, and passing information to, the element responsible for conducting the deliberate breach (see [Figure 3-12F](#)).

SECTION 7 — INFILTRATION AND EXFILTRATION

INFILTRATION

Infiltration is a form of maneuver that the scout platoon can use to penetrate the enemy security zone or main battle area to accomplish a specific task. It is most commonly used by ground reconnaissance assets, although aerial platforms may also employ tactics based on infiltration techniques.

During infiltration, the platoon's elements use predesignated lanes to reach their objective without being detected or engaged by the enemy. The infiltrating elements employ cover, concealment, and stealth to move through identified or templated gaps in the enemy array. Purposes of infiltration include the following:

- Reconnoiter a specified area and establish OPs.
- Emplace remote sensors.
- Establish communications relay capability for a specific period in support of other reconnaissance operations.
- Determine enemy strengths and weaknesses.
- Locate unobserved routes through enemy positions.
- Determine the location of high-payoff enemy assets.

The scout platoon can infiltrate by squads, by sections, or as a complete platoon. [Figures 3-13A through 3-13C](#) illustrate an infiltration operation.

Planning and coordination

The amount of intelligence information available to the scout platoon leader during the planning process will determine the risk involved in conducting the infiltration. As he plans the operation, the platoon leader must select appropriate routes and movement techniques based on the mission, terrain and weather, likelihood of enemy contact, speed of movement, and the depth to which the platoon's elements must penetrate. Once these factors have been considered, the platoon leader must make the decision to infiltrate either mounted or dismounted. Even if he decides the platoon can conduct a mounted infiltration, his plan must take into account that the situation may require scouts to dismount and reconnoiter an area before the vehicles move forward. The platoon leader's infiltration plan must provide platoon elements with enough time for preparation and initial movement.

The platoon leader must conduct detailed coordination with any friendly elements through which the platoon will pass when executing infiltration tactics; this includes integration of communications, fires, and CSS activities. In addition, the platoon's higher headquarters must coordinate the activities of adjacent friendly units to ensure they do not compromise the scout platoon and its elements as they conduct the infiltration.

Size of infiltrating elements

The size of the elements depends on several factors: the assigned mission, time available, cover and concealment, the target acquisition capabilities of both friendly and enemy forces, available communications assets, and navigation capabilities and limitations. If the platoon is tasked to gather

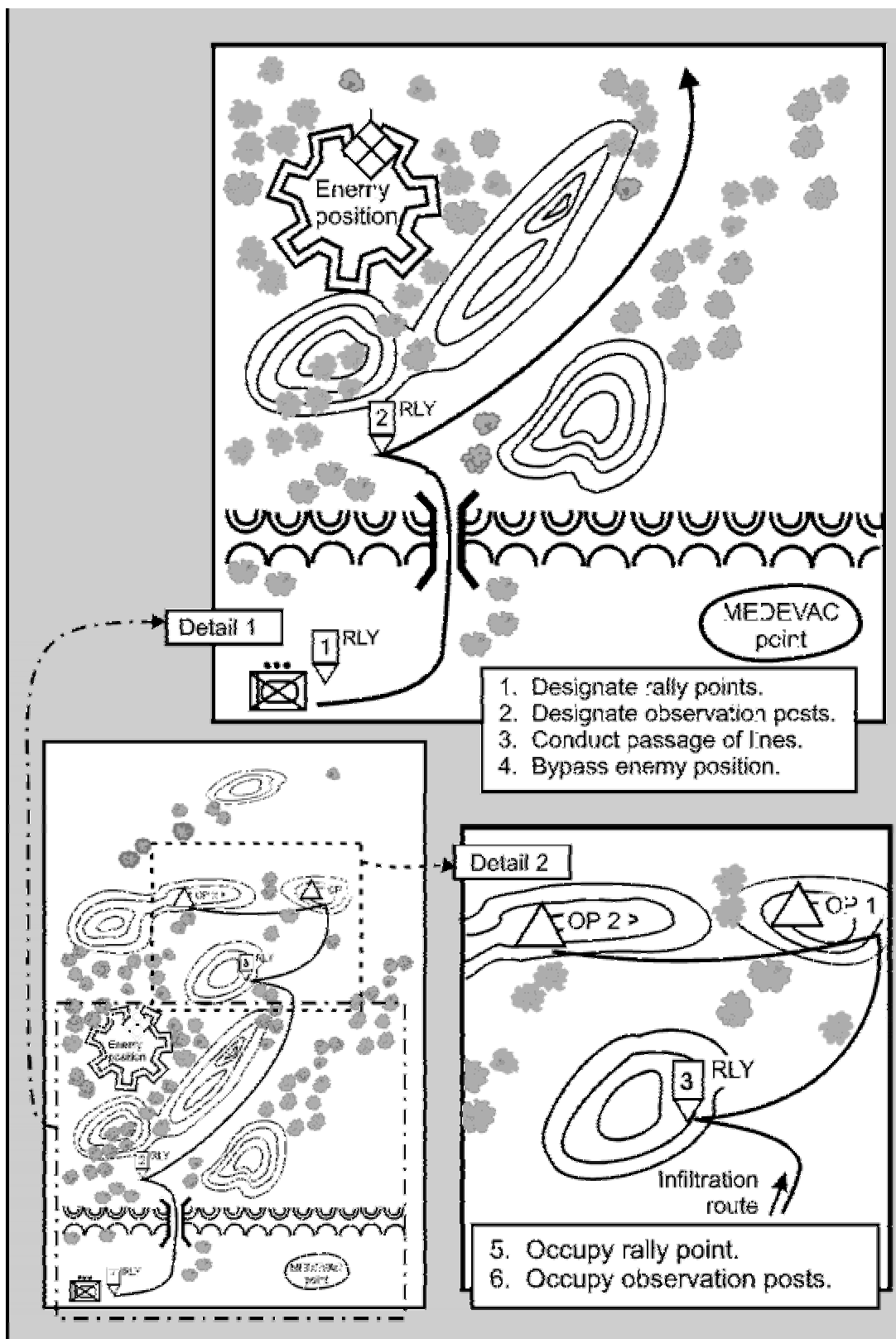

Figure 3-13A. Infiltration scheme of maneuver.

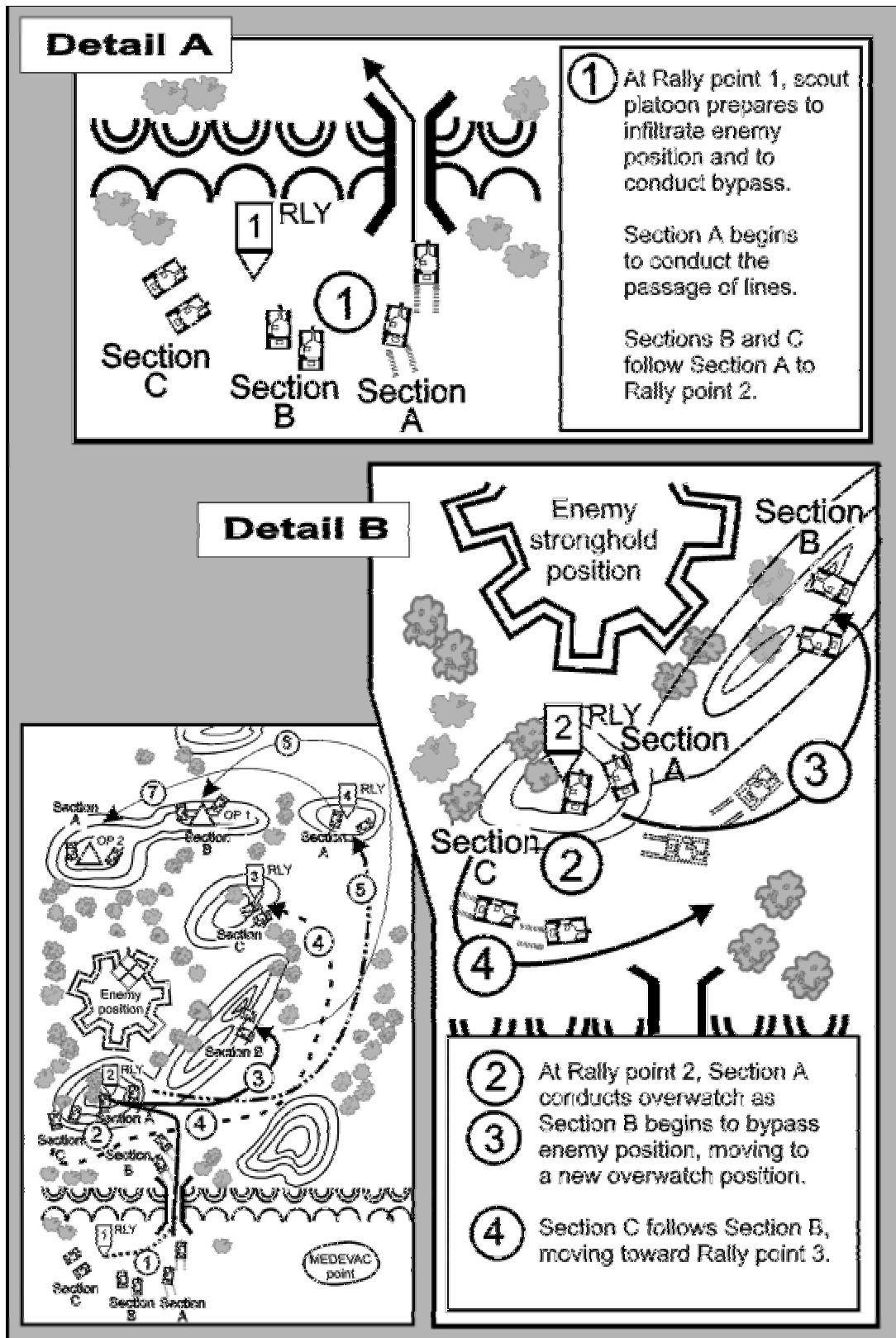

Figure 3-13B. Bypass of the enemy position.

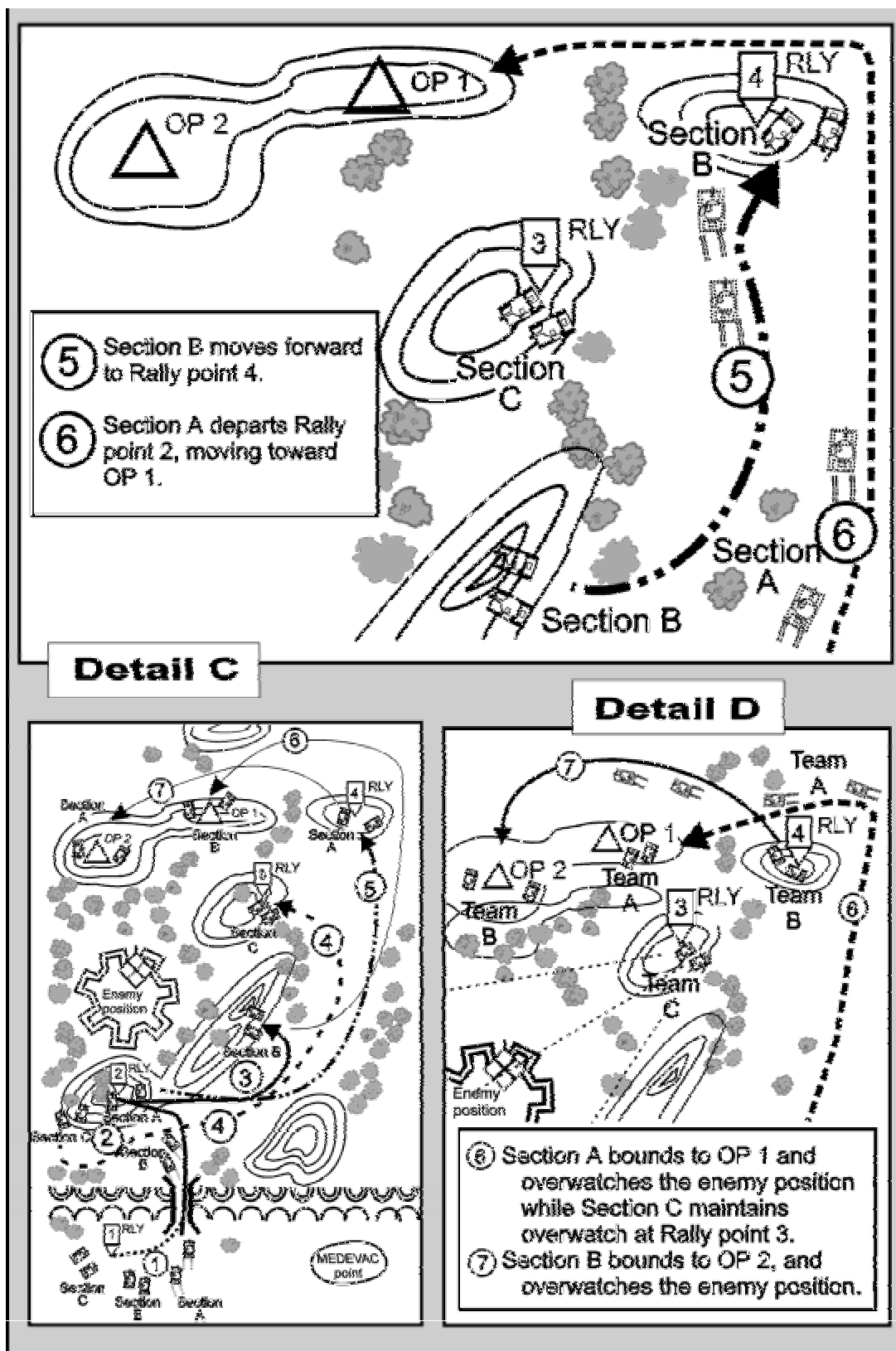

Figure 3-13C. Movement to OPs and reconnaissance of the enemy position.

information over a wide area, it may employ several small teams to cover the complete sector. In most situations, smaller elements are better able to take advantage of available cover and concealment.

Infiltration lanes or routes

The scout platoon's higher headquarters will assign the platoon an infiltration lane or zone, requiring the platoon leader to gather the necessary information and intelligence to prepare for the mission. The platoon leader must decide whether to move the entire platoon along a single lane or assign separate lanes for each section or squad.

Each alternative presents both advantages and disadvantages. Moving the entire platoon on a single lane makes navigation and movement easier to control, but it can increase the chance of the platoon being detected by enemy forces. Moving on multiple lanes may require development of additional control measures, make command and control more difficult, and create navigation problems. On the other hand, it can reduce the chances of detection by the enemy.

In choosing infiltration lanes, the platoon leader must ensure that lanes afford sufficient width to allow each element to change its planned route to avoid unexpected enemy contact. He must also consider civilian activity along each lane and within the infiltration zone as a whole.

Communications

In general, infiltrating elements should maintain radio listening silence except to send critical information that the commander has directed to be reported immediately or to report contact with enemy forces. When operating out of range of normal radio communications, an infiltrating element that must transmit required information should move to high ground or set up a long-range expedient antenna. (**NOTE:** Refer to [Chapter 9](#) of this manual for information on construction of field expedient antennas.)

Fire support

Infiltration plans always cover employment of indirect fires, although they are used only in limited circumstances. The most common use is when the infiltrating unit makes enemy contact. The commander or platoon leader may employ indirect fires in another sector to divert attention from the infiltration lane. Indirect fires can also be useful in degrading the enemy's acquisition and observation capabilities by forcing him to seek cover.

Actions on contact

Each infiltrating element must develop and rehearse a plan that clearly defines its actions in case of contact with enemy security forces. If detected, an infiltrating element will return fire, break contact, and report. Fighting through the enemy force, however, is the least preferred COA. Direct fire engagements are normally limited to whatever actions are required to break contact.

During infiltration using multiple lanes, the detection of one platoon's elements may alert the enemy and compromise other units in the infiltration zone. The OPORD must clearly state whether the element will continue the mission or return to friendly lines if it is detected by the enemy. If the element makes visual contact but is not detected, it should continue the mission.

EXFILTRATION

The scout platoon and its elements may have to conduct exfiltration in several types of tactical situations. For example, reconnaissance forces that infiltrate the enemy main battle area or rear area must exfiltrate once they gather the required information. In another instance, the platoon may be deliberately employed in a stay-behind mode during defensive operations, forcing it to use exfiltration to return to friendly lines.

Planning considerations

In all situations, exfiltration must be planned as carefully as infiltration. An effective exfiltration plan is essential in terms of mission accomplishment and morale. In most cases, planning for an exfiltration operation begins at the same time as planning for the infiltration (or other tactical operation) that precedes it. For example, the scout platoon leader must anticipate contingency measures that may be required if his elements must conduct an unplanned exfiltration during a reconnaissance operation. His exfiltration plan should factor in additional time that the platoon may need to react to unforeseen circumstances, such as inadvertent contact with enemy forces or unexpected restrictive terrain. Whether the platoon plans to exfiltrate on foot or by another transport method (ground vehicles, aircraft, or watercraft), detailed planning is required to establish criteria for a passage of lines to minimize the chances of fratricide. The exfiltrating force must also be prepared to conduct additional planning once the operation is under way, particularly if enemy contact occurs.

The exfiltration plan should also cover other types of contingencies that will not require the platoon to exfiltrate. For example, when a section or squad repeatedly misses mandatory radio contact, it must be assumed that the element has a communications problem, is in trouble, or both. The exfiltration plan might address this situation by calling for a resupply drop of new batteries and another means of communication at a predetermined location. The plan would mandate that the resupply location be specially marked to ensure that the equipment does not fall into enemy hands.

Movement considerations

The principles of route selection, movement formations, and movement security are critical to the success of the exfiltration operation. Plans for extraction by applicable means (ground, air, or water) must be developed before the operation, covering procedural contingencies such as the loss of vehicles, evacuation of sick and wounded personnel, and disruption of communications. These plans should address various contingencies for movement, such as the possibility that the platoon may be able to exfiltrate intact or the option of breaking into smaller groups to avoid detection.

Terrain factors and pickup points

The scout platoon uses terrain features to its advantage during the exfiltration. It employs movement routes that put ridge lines, rivers, and other restrictive terrain between the platoon and enemy security forces. The platoon leader ensures that primary and alternate linkup points are not on a single azimuth leading away from the OP or exfiltration route.

Exfiltration pickup points for dismounted personnel should be far enough away from the OP to ensure the enemy does not hear vehicle or helicopter noises. The exfiltrating force should use mountains, dense foliage, and other terrain features to screen these noises. Under normal conditions in flat, open terrain on a clear night, rotary-wing aircraft lose most of their audio signature at a distance of approximately 5

kilometers.

Methods of exfiltration

Exfiltration can be conducted by air, water, or land. Each alternative presents the scout platoon with specific operational considerations as well as tactical advantages and disadvantages. The exfiltration plan and the OPORD must address these factors as well as operational contingencies such as actions the reconnaissance unit will take if an unplanned exfiltration becomes necessary.

Extraction by air or water means is favored when the resources are available and their use will not compromise the mission. These methods are used when long distances must be covered, time of return is essential, the exfiltration zone lacks adequate cover and concealment, the enemy does not have air or naval superiority, or heavily populated hostile areas obstruct ground exfiltration.

Reconnaissance forces normally conduct exfiltration via land routes when friendly lines are close or no other extraction method is feasible. Ground exfiltration is preferred when areas along the route are largely uninhabited, when enemy forces are widely dispersed or under such pressure that they cannot conduct counterreconnaissance and security operations, or when terrain is sufficiently restrictive to degrade enemy efforts to use mobile forces against the exfiltrating reconnaissance unit.

Emergency exfiltration

The scout platoon may have to conduct emergency exfiltration if it is detected or engaged by an enemy force. This type of operation requires activation of an escape and evasion plan or deployment of a reaction or support force to assist with the extraction of friendly elements. Employment of the reaction force and supporting fires must be carefully coordinated and rehearsed before the infiltration (or other tactical mission, if applicable) is initiated.

CHAPTER 4

Security Operations

In security operations, security forces protect the main body from enemy observation and surprise attack. They provide the main body commander with early warning, allowing him to concentrate his combat power at the right place and time to defeat the enemy. There are four types of security missions: screen, guard, cover, and area security.

CONTENTS

<u>Section 1</u>	<u>Purpose and Fundamentals</u>
<u>Section 2</u>	<u>Screening Missions</u>
<u>Section 3</u>	<u>Area Security Operations</u>

SECTION 1 — PURPOSE AND FUNDAMENTALS

PURPOSE

All security missions serve the same general purpose: they prevent the main body from being observed or attacked unexpectedly by the enemy. These operations are conducted forward, to the flanks, or to the rear of the main body. The scout platoon may operate at considerable distances from the main body it is screening (limited only by communications capabilities and the range of indirect fire support). This provides the main body with time and space to react and to position forces to fight the enemy.

The scout platoon can conduct screening and area security operations independently or as part of a larger force such as a cavalry troop or a company team. In conducting guard and cover missions, the scout platoon works as part of a larger unit such as a battalion or squadron; in addition, the platoon may be tasked to conduct screening or reconnaissance missions in support of the larger unit's guard or cover mission.

Screen

A screening force provides early warning to the main body and impedes and harasses the enemy with direct and indirect fires. Within its capabilities and based on the commander's guidance, it destroys enemy reconnaissance units in coordination with other combat elements.

Screening missions, which are defensive in nature, provide the protected force with the lowest level of protection of any security mission. They are conducted to the front, flanks, and rear of a stationary force

and to the flanks and rear of a moving force. The screening force normally operates within the range of the supporting artillery. The scout platoon generally accomplishes a screening mission by establishing a series of OPs and conducting patrols to ensure adequate surveillance of the assigned sector.

Guard

A guard force is deployed over a narrower front than is a screening force. It accomplishes all the tasks of a screening force, with the additional task of preventing enemy ground observation of and direct fire against the main body. A guard force reconnoiters, attacks, defends, and delays as necessary to accomplish its mission. It normally operates within the range of the supporting artillery. Guard operations are not conducted below task force or squadron level.

Cover

A covering force accomplishes all the tasks of screening and guard forces to deceive, disrupt, and destroy enemy forces. The key distinction of the cover mission is that the force operates apart from the main body to allow early development of the situation. Unlike screening or guard forces, a covering force is tactically self-contained; it is normally a reinforced separate brigade or cavalry regiment. It is organized with sufficient CS and CSS assets to operate independent of the main body. Because the covering force (or a portion of it) can be decisively engaged by an enemy force, it must have sufficient combat power to effectively engage the enemy.

Area security

Area security missions are conducted to provide reconnaissance and security in support of designated personnel, facilities (including airfields), unit convoys, main supply routes, lines of communications, equipment, and critical points.

FUNDAMENTALS

Five fundamentals, described in the following paragraphs, are common to all security missions. The scout platoon leader's plans must adhere to these fundamentals as the scouts execute their mission.

Orient on the main body

If the main body moves, the scouts must be aware of its move and must reposition their forces accordingly. Scouts must understand the main body commander's scheme of maneuver and where he wants his screening force in relation to his movement. The screen must be positioned where it can provide the needed security.

Perform continuous reconnaissance

The scout platoon conducts continuous reconnaissance during security operations to gain as much information as possible about the area of operations and the enemy.

Provide early and accurate warnings

Early and accurate warning of enemy approach is essential to successful operations. The main body commander needs this information to shift and concentrate his forces to meet and defeat the enemy. Scouts occupy OPs and conduct patrols to provide long-range observation, to observe enemy movement,

and to report the enemy's size, location, and activity to the main body commander.

Provide reaction time and maneuver space

The scout platoon works at sufficient distance from the main body to identify and report on the enemy so the main body commander can react accordingly. The platoon provides additional reaction time and/or maneuver space by employing indirect fires to slow the enemy's rate of advance.

Maintain enemy contact

Scouts gain and maintain contact with the enemy to provide the commander with continuous information. If they lose contact, they take steps to regain it. They then maintain contact until ordered to do otherwise.

SECTION 2 — SCREENING MISSIONS

Scouts conduct screen missions for their parent unit or other combined arms forces to provide early warning of enemy approach and to provide real-time information, reaction time, and maneuver space for the main body. A commander calls on scouts to screen for him when he needs advance warning of when and where the enemy is attacking. Operating over an extended area, the platoon fights only for self-protection and remains within its capabilities. It denies enemy reconnaissance units close-in observation of the main body.

CRITICAL TASKS

During a screening mission, the scout platoon must accomplish the following critical tasks:

- Maintain continuous surveillance of all assigned NAIs or high-speed avenues of approach into the sector.
- Provide early warning of enemy approach.
- Within capability and based on the commander's guidance, identify enemy reconnaissance units and, in coordination with other combat elements, destroy them.
- Gain and maintain contact with the enemy main body and report its activity.
- Impede and harass the enemy main body by controlled use of indirect fires.

Scouts maintain surveillance from a series of OPs along a screen line or in depth. The screen line, normally a phase line on a map, designates the most forward location of the OPs. Commanders must carefully weigh time and distance factors when choosing where to place this line. If the scout platoon leader does not receive a screen line location from his commander, he should ask for it. In executing a screen mission, scouts conduct active patrolling to extend their observation range or to cover dead space and the area between OPs. Unless they have to, they do not fight with their direct fire weapons. Indirect fire is their primary means of engaging the enemy. They use direct fire primarily for self-defense.

When planning a screen mission, the scout platoon leader uses the critical task requirements covered in the following discussion as a guide to prioritizing and sequencing the mission. He must address each requirement.

Conduct surveillance of assigned areas

The first task that must be accomplished is to provide surveillance of the assigned area of operations.

Surveillance requirements. Generally, scouts are assigned to screen along a lateral line (the screen line). This can be misleading, however. The scout screen is actually set to observe specific avenues of approach or, more specifically, NAIs. The screen line merely indicates the limit of the forward positioning of the scouts. Along with the screen line graphic, the scout platoon leader must have an event template/matrix; he may also have a decision support template.

The areas the platoon is tasked to observe should be identified in either the reconnaissance and security plan the platoon leader receives or in the OPORD from higher headquarters. If the platoon does not receive an IPB product, the higher OPORD must specifically state where it must focus the screening operation. If the platoon is assigned multiple requirements, the higher headquarters must prioritize them.

In a task force, the scout's understanding of his commander's intent and guidance is the most critical aspect of planning the screen mission. More important than the specifics of where to orient is the focus on what to look for. There are three choices for this focus: the enemy main body, the enemy reconnaissance effort, or both. The intent should specify which one the scout will focus on or, if both are required (as is often the case), which has priority.

This guidance will then determine where the platoon will orient and how it will allocate resources. If the commander's priority is locating the main body, the scout will focus most of his assets on the main avenues of approach and accept risk on the reconnaissance avenues of approach (RAA). If the commander's priority is on counterreconnaissance, the scout will put priority on the RAA and accept some risk on the main avenue. If the commander wants both, with equal priority, the scout must plan to transition from the RAA to the main avenue at a designated point in the battle. The commander will usually order this transition based on the enemy situation.

NOTE: An enemy RAA may mirror or parallel the intended route of an enemy maneuver force, or it may follow a route that facilitates observation of key terrain or friendly forces but is unrelated to the enemy scheme of maneuver.

Surveillance assets. Once the scout platoon leader has a thorough understanding of what his surveillance requirements are, he must next determine what assets he has available to execute these requirements. Availability of assets is dependent on how long the screen must remain in place and how the platoon is task organized. Among the assets that can enhance the platoon's surveillance capability are GSR, infantry squads, tank platoons or companies, engineer reconnaissance teams, artillery forward observers (FO), and aviation assets. If the screen will be of short duration (less than 12 hours), individual scout squads can emplace and man separate OPs. If the duration of the screen is unknown or longer than 12 hours, the platoon leader must consider assigning a two-vehicle section (CFV scout platoon) or three-vehicle section (HMMWV scout platoon) for each OP to facilitate continuous operations. Refer to [Chapter 6](#) of this manual for further details on air/ground reconnaissance integration.

Surveillance techniques. To ensure that the critical task of surveillance of assigned reconnaissance objectives is accomplished, the platoon leader and his higher headquarters apply a combination of techniques to make the most efficient use of their assets. (**NOTE:** Refer to [Chapter 8](#) of this manual for a discussion of surveillance methods, including OPs, patrols, and use of electronic and mechanical assets.)

Task organization. The platoon leader will task organize the platoon and any other assigned assets to achieve the most effective surveillance of an NAI or avenue. He may also employ assets not under his direct control, but rather under the command of the troop or battalion. As noted, these assets could be tank elements, engineer or infantry squads, GSR, artillery observers, and aviation assets. (**NOTE:** When the platoon leader does not control the assets directly, he must ensure that his dispositions complement those of the other forces in the screen and do not duplicate them unnecessarily. In addition, he must ensure that all scouts understand where these forces are and what role they are playing.)

The platoon leader may employ these surveillance assets in a number of ways. These may include adjusting the number of scout sections or squads in a particular surveillance team; mixing scouts and other assets such as engineers, artillery, GSR, or infantry into the same team; or maintaining elements in pure teams under the platoon leader's control. The platoon leader must consider the characteristics of the NAI or avenue when task organizing for surveillance. These considerations will determine whether the platoon will need to call for fire or conduct dismounted patrols; they will also affect the field of view and applicability of GSR.

[Figure 4-1](#) illustrates how the scout platoon might be task organized for surveillance operations. [Figure 4-2](#) shows employment of a tank company team to supplement the platoon.

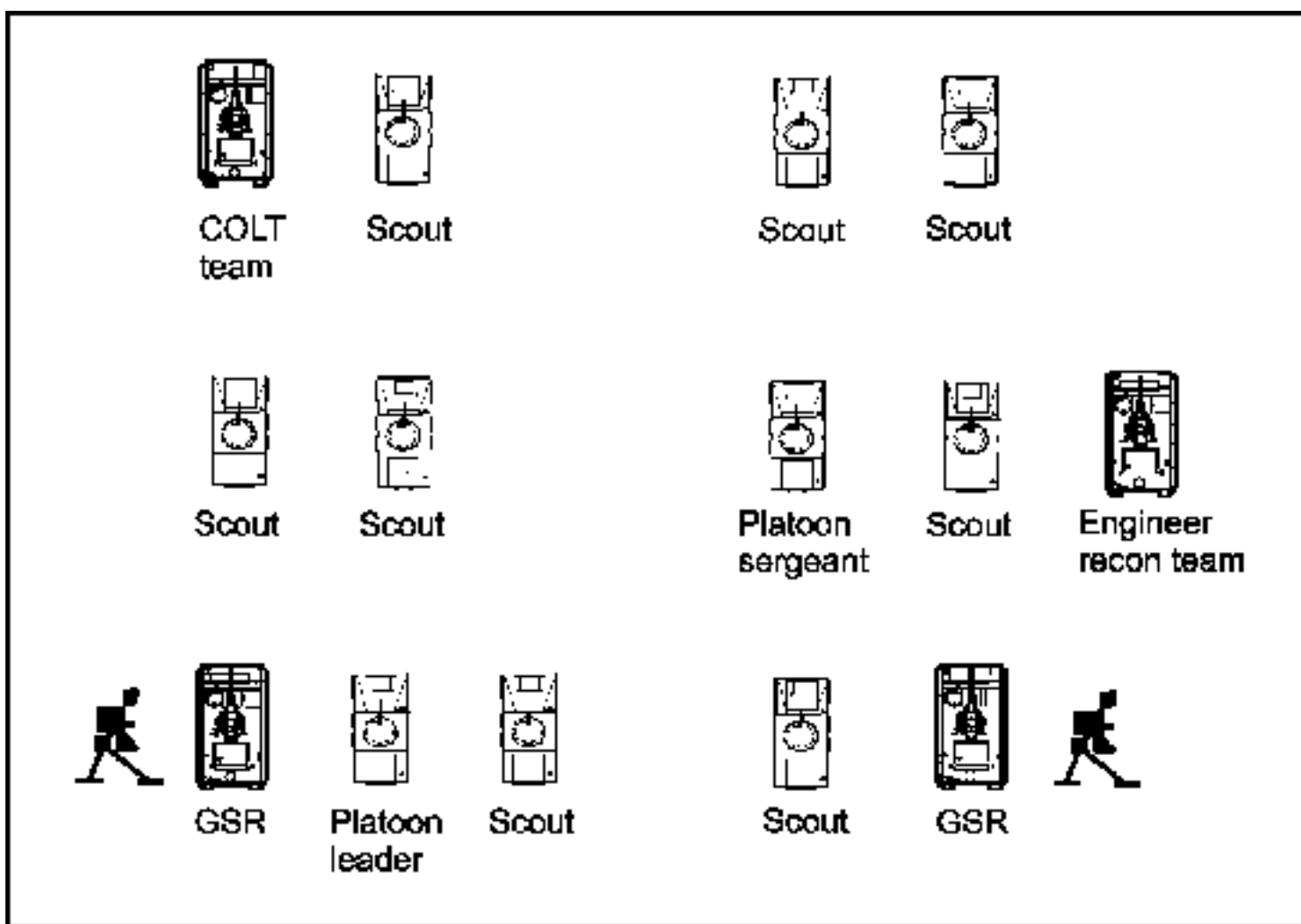

Figure 4-1. Sample scout platoon task organization.

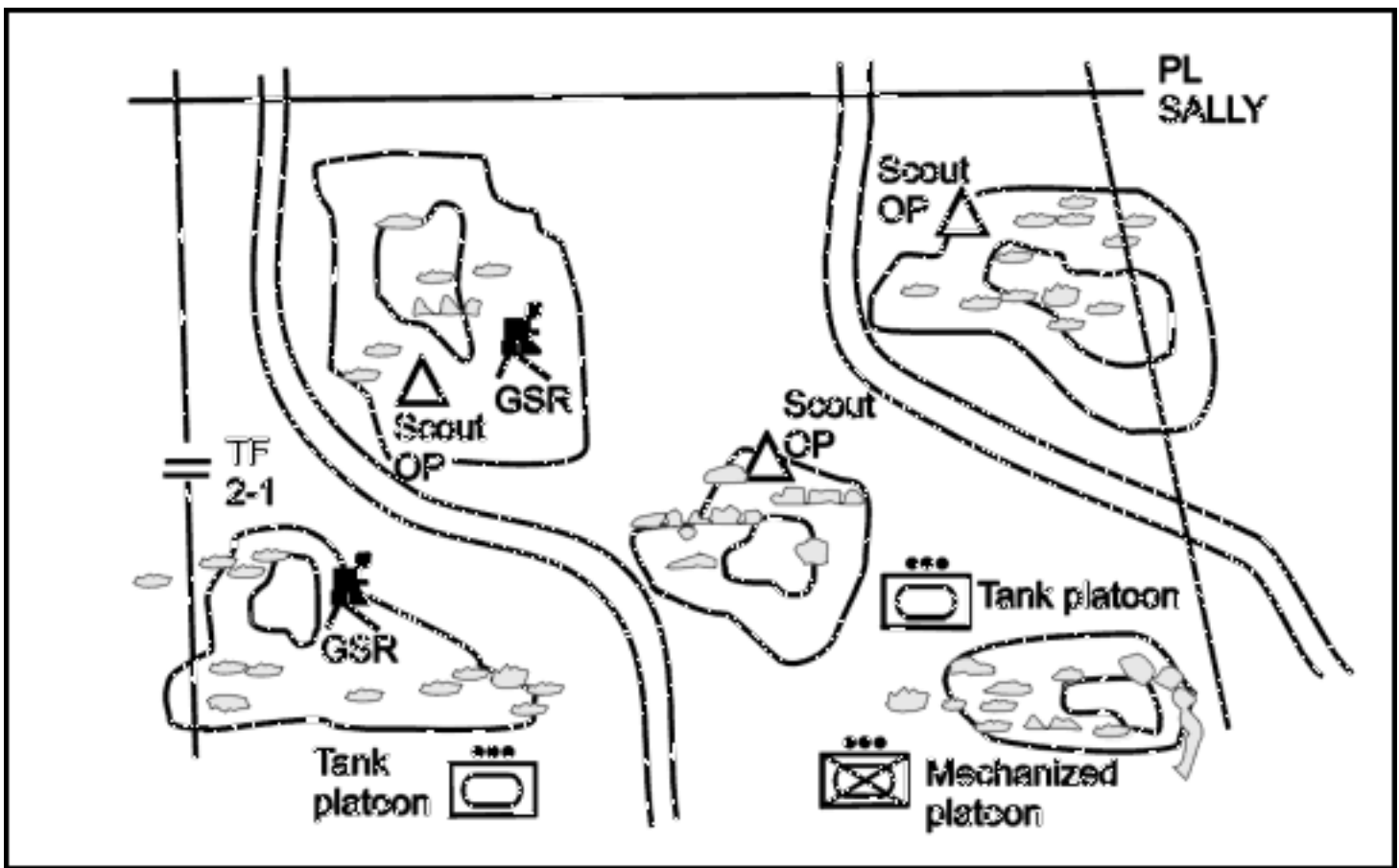

Figure 4-2. Tank company team employed to supplement a scout screen.

Redundancy. The platoon leader may task more than one element to observe a particular assigned NAI or avenue. He does this based on the nature of the NAI or avenue in terms of size, terrain, or importance. For example, a very large avenue may require multiple observation assets to ensure all aspects of the avenue are covered. Terrain that is very broken or mixed with areas of thick vegetation may require more than one asset to ensure that adequate continuous coverage is achieved. Finally, if a particular NAI is assigned significant priority by the commander, the scout platoon leader may assign multiple elements to cover it. Redundancy not only ensures that an NAI or avenue is adequately observed, but also enables the unit to accomplish the mission even if some assets are compromised by enemy forces. [Figure 4-3](#) illustrates redundancy of observation assets.

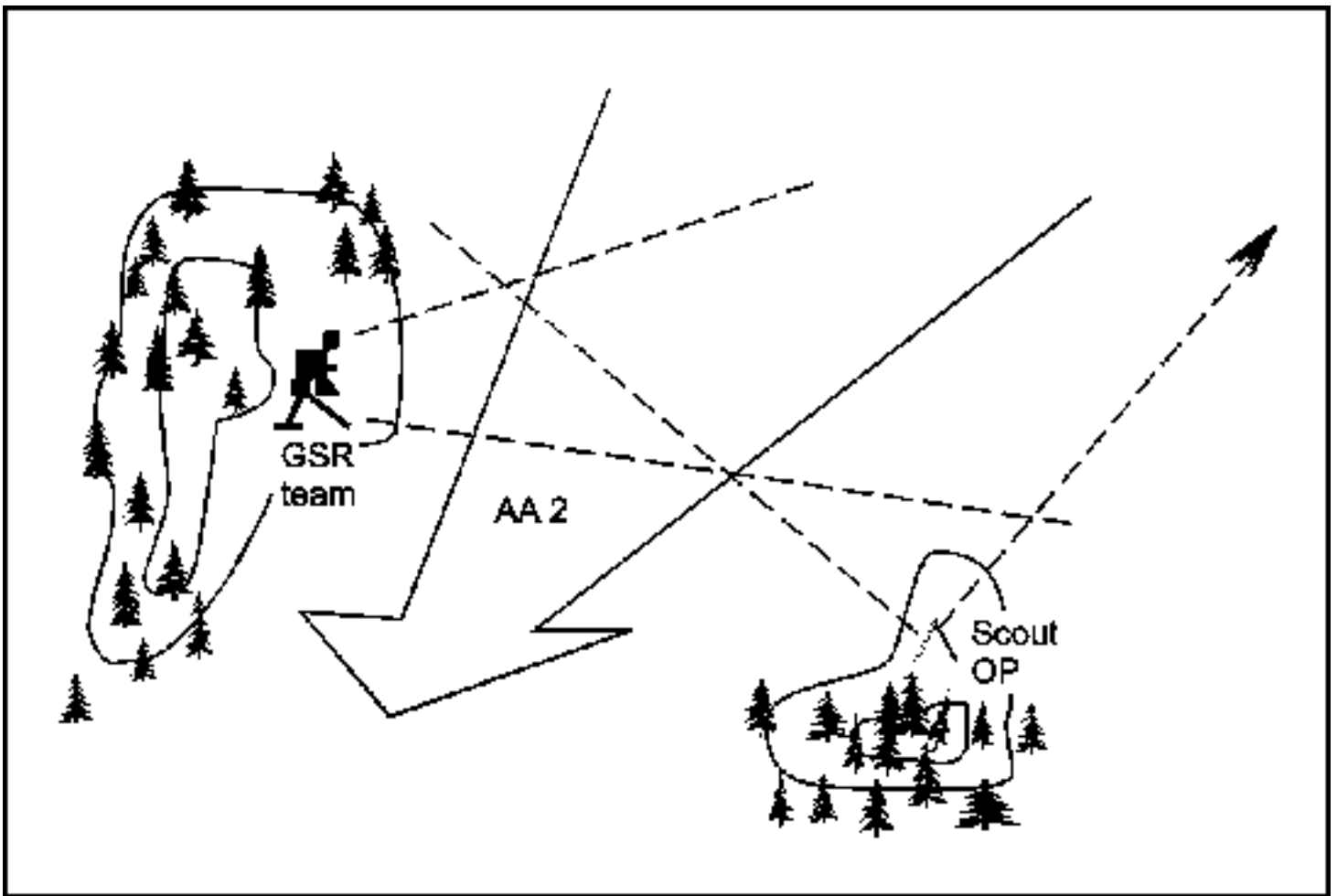

Figure 4-3. Redundant coverage of an avenue of approach.

Cueing. Cueing is a technique the scout platoon leader can use to cover an NAI or avenue when assets are limited and he lacks the capability for redundancy. He plans contingency tasks that will increase surveillance on a particular NAI; his surveillance teams execute the tasks when "cued" by activity at that NAI.

The NAI or avenue is covered initially either by a single surveillance team or by a remote or electronic signaling device such as a trip flare or the platoon early warning system (PEWS). When activity is detected, other teams move into preselected positions to add their capabilities to the surveillance of the NAI or avenue. Refer to [Figure 4-4](#).

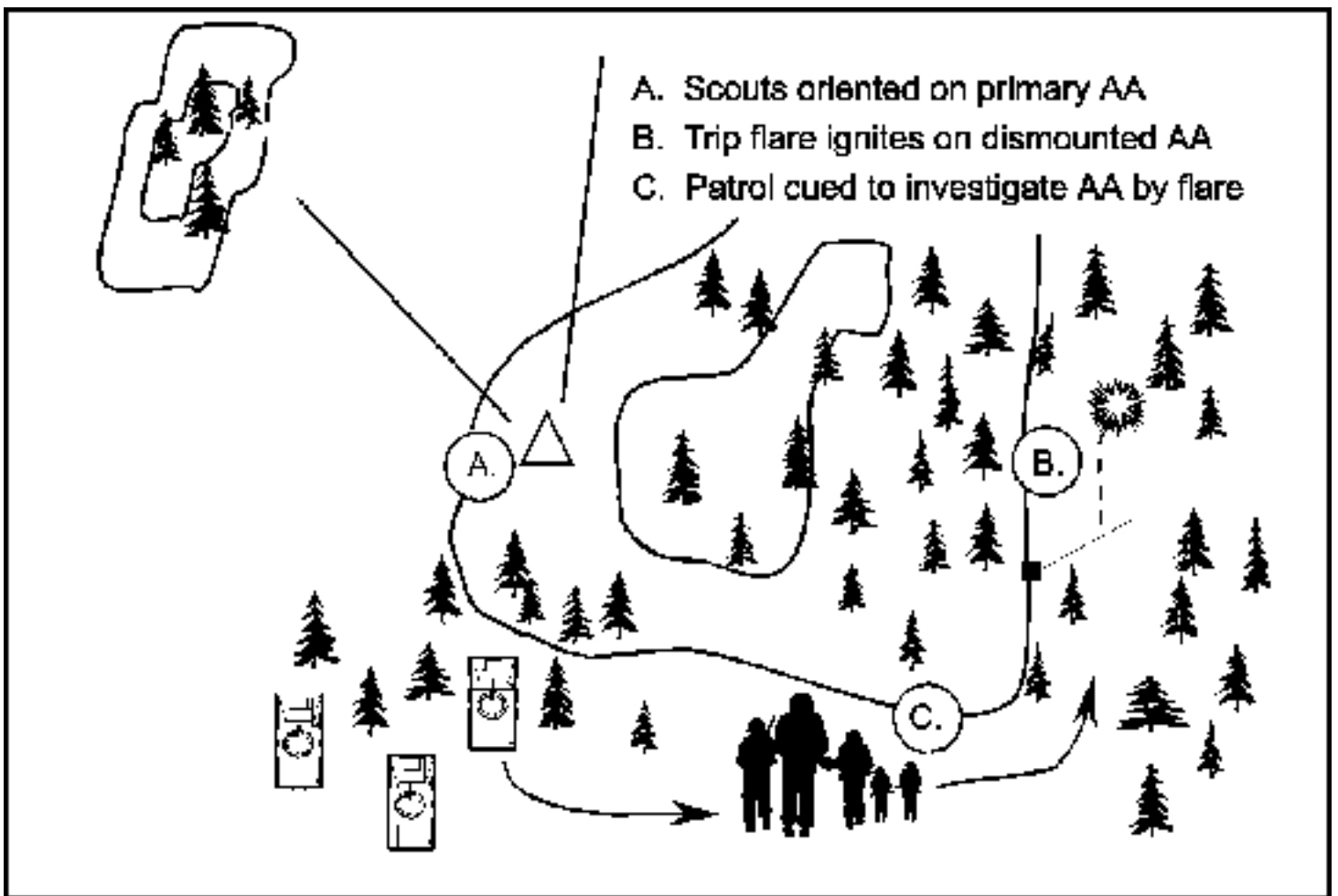

Figure 4-4. Use of trip flare to cue a patrol.

Provide early warning

The scout platoon's second critical task is to provide early warning of an enemy approach. Effective early warning requires planning for communications in detail. The platoon leader looks at communications distances and significant terrain features to identify potential FM communications problems. If he anticipates problems, he can address them by requesting support from higher (in the form of battalion retrans) or by planning for radio relays and directional antennas. See [Figure 4-5](#).

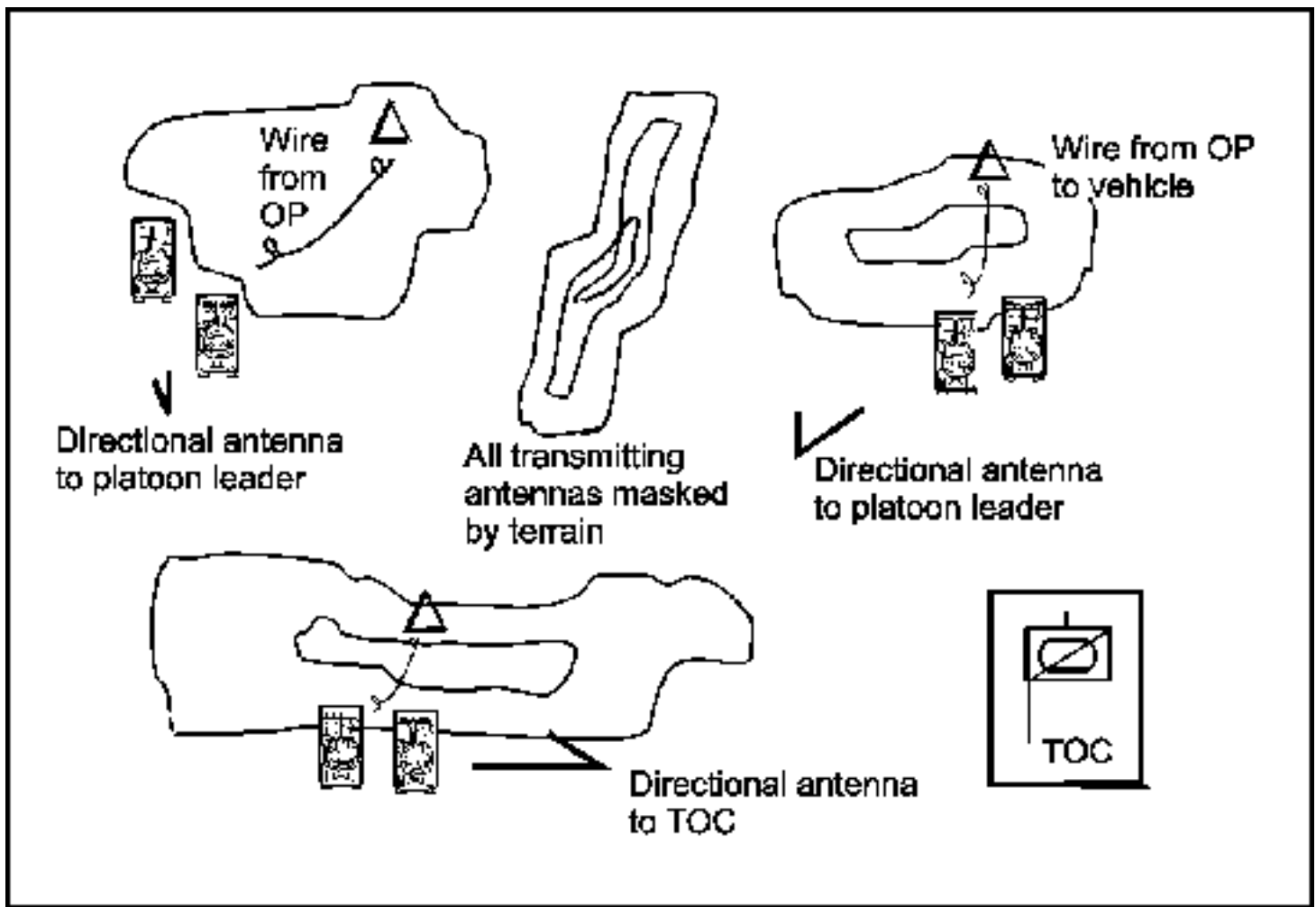

Figure 4-5. Platoon communications setup.

Perform counterreconnaissance

Once the platoon leader has planned surveillance of assigned reconnaissance objectives and has ensured that he can provide early warning, he must next evaluate the enemy's reconnaissance effort and the platoon's assigned role in the conduct of counterreconnaissance operations. These operations consist of two elements: acquiring and killing. The most appropriate role for the scout platoon in counterreconnaissance is acquiring enemy reconnaissance assets rather than killing them, although it does have limited killing capability.

The commander's guidance must specifically define the role of the scout in counterreconnaissance operations. Once he has a thorough understanding of his commander's intent, the scout platoon leader must consider four factors when planning to acquire enemy reconnaissance elements: enemy reconnaissance avenues of approach (RAA); when and under what conditions enemy reconnaissance forces are likely to be encountered; the likely composition of the enemy reconnaissance in terms of size, organization, and equipment; and the identity and location of friendly reconnaissance-killing forces.

Enemy reconnaissance forces are not likely to use primary RAAs to execute their mission. To acquire their assigned reconnaissance objectives, the scouts must be oriented on trails, rough terrain, and dead space that allow mounted movement, but only for small teams of vehicles. They must also realize that enemy reconnaissance is most likely to move during darkness and periods of limited visibility. A thorough understanding of the composition of enemy reconnaissance elements will allow the scout to

more accurately determine what their likely RAAs are and how best to acquire them.

Other assets in the troop or battalion will be given the specific mission of killing enemy reconnaissance behind the screen line where initial acquisition occurs. Once the scouts locate enemy reconnaissance elements, they must use their thorough knowledge of the terrain and of the location and capabilities of the friendly killing force to coordinate battle handover of the enemy forces.

The counterreconnaissance task is extremely resource-intensive. It is generally most effective when conducted by an element larger than a single scout platoon. Most often, the scout platoon by itself does not have sufficient assets to both acquire and kill the enemy. In addition, it may not be able to cover all RAAs and still maintain surveillance on the enemy's main avenues of approach. The commander's intent is critical to resolving this dilemma.

When the scout platoon must acquire both enemy reconnaissance elements and the main body, the priority in the early stages of the mission will be on the reconnaissance forces, focusing on the RAAs. The platoon will then track the echeloned arrival of enemy elements on the battlefield and shift priority to the main avenues of approach at the appropriate time. This technique permits the platoon to time-phase its priorities based on battlefield conditions. The platoon leader, however, must recognize when to change priority to the main avenue and then execute the change successfully. See [Figures 4-6A](#) and [4-6B](#).

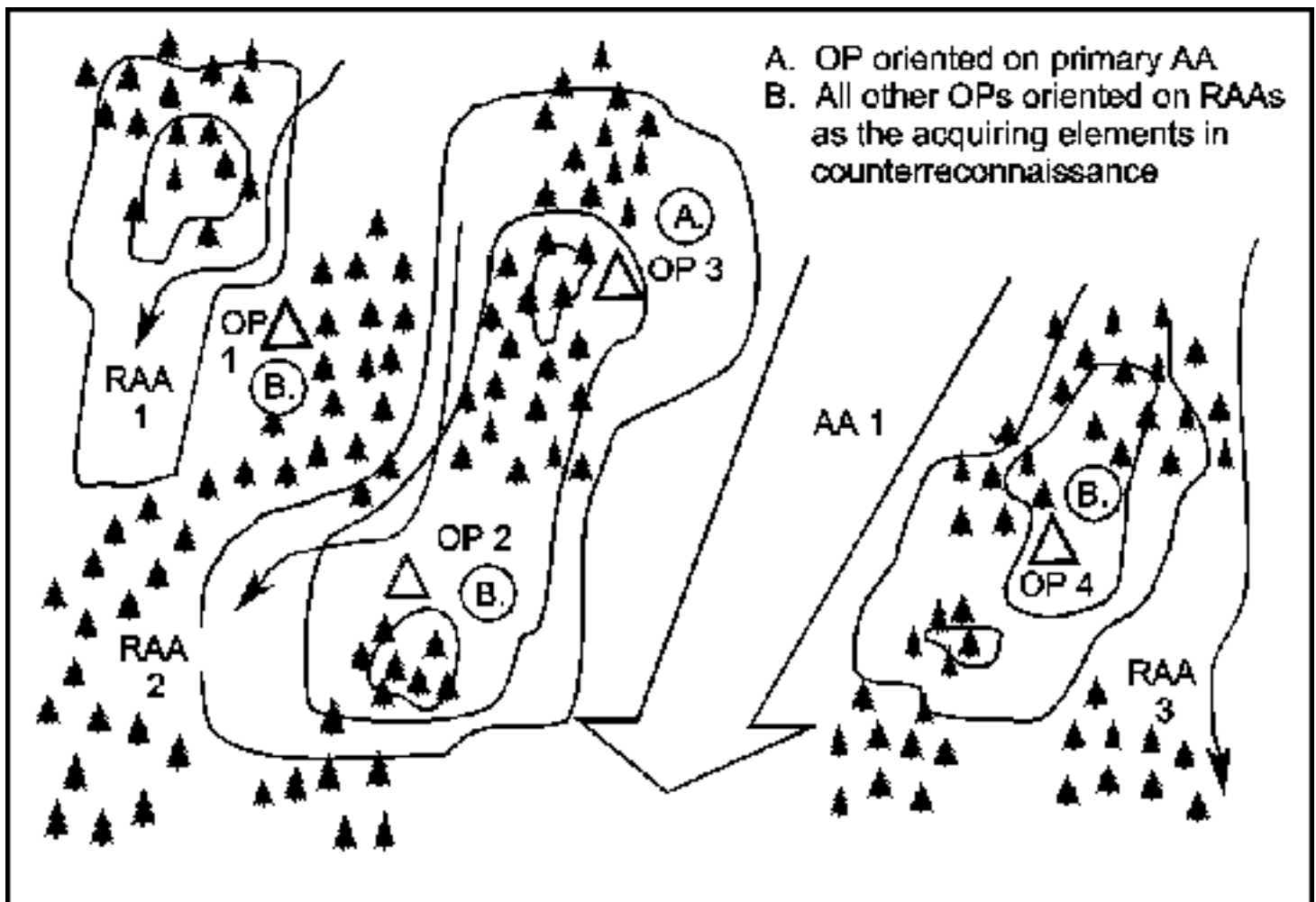

Figure 4-6a. Changing the screen priority (initial priority to counterreconnaissance).

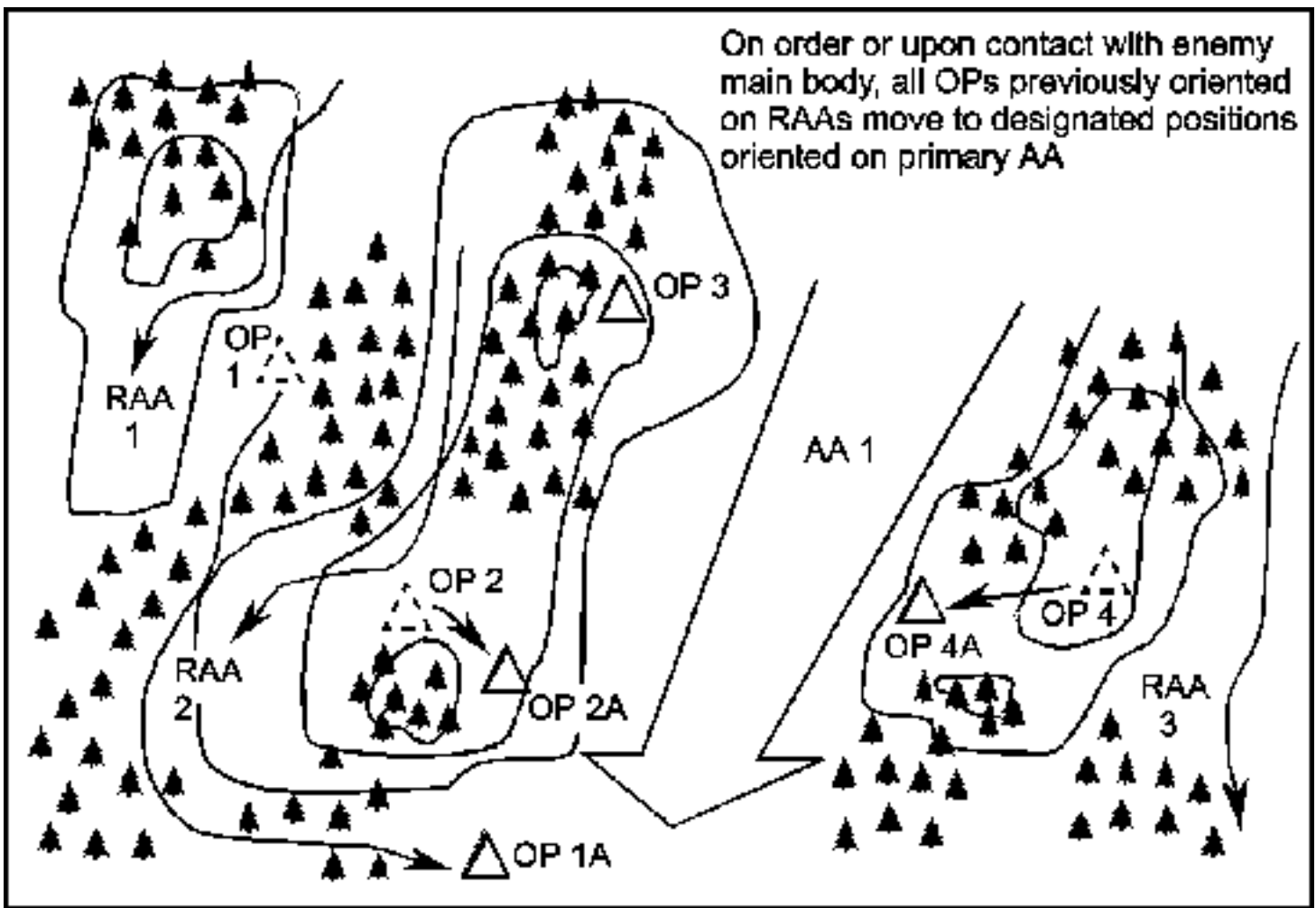

Figure 4-6B. Changing the screen priority (priority changed to main avenue of approach) (continued).

Maintain contact

After locating the main body of the enemy, the scout platoon must maintain contact with it until authorized to hand over contact to another friendly element. This is one of the most difficult tasks for the individual scout section or squad to accomplish and therefore is best accomplished through a platoon effort.

The preferred method of maintaining contact with a moving enemy main body is to position echeloned OPs in depth along the avenue of approach. This allows contact to be handed off from one OP to another without the requirement for the OPs to physically displace. This technique requires that the scout platoon have enough assets to pre-position the OPs in depth. See [Figure 4-7](#).

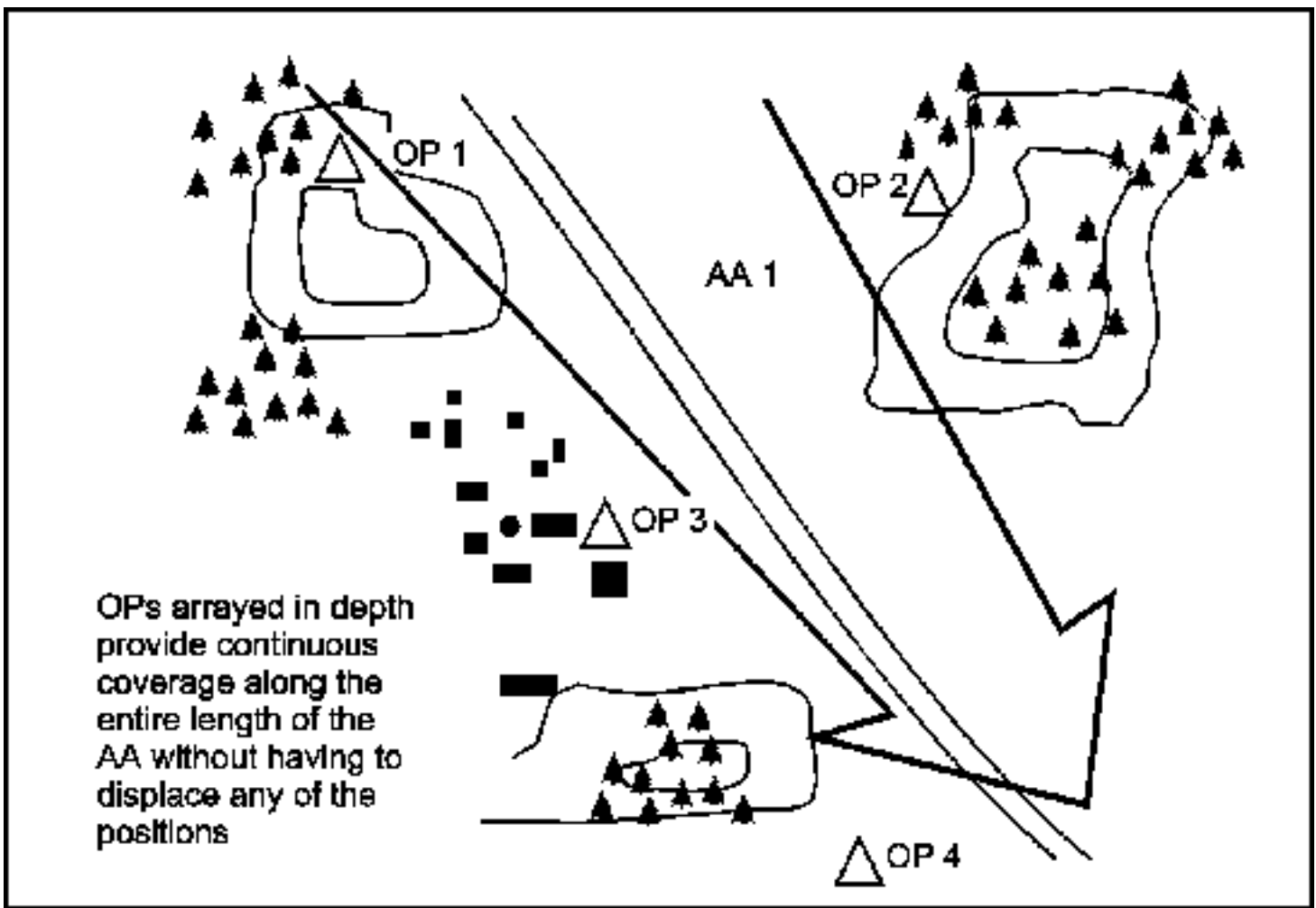

Figure 4-7. Positioning OPs in depth.

Another technique used to maintain contact is to displace in front of a moving enemy. This technique is very difficult because the scouts must move to the rear faster than the enemy is moving forward. This often exposes the scouts to enemy fire. Additionally, if they attempt to use covered and concealed routes only, they risk moving too slowly, being overrun or outrun by the enemy, and losing contact. See [Figure 4-8](#).

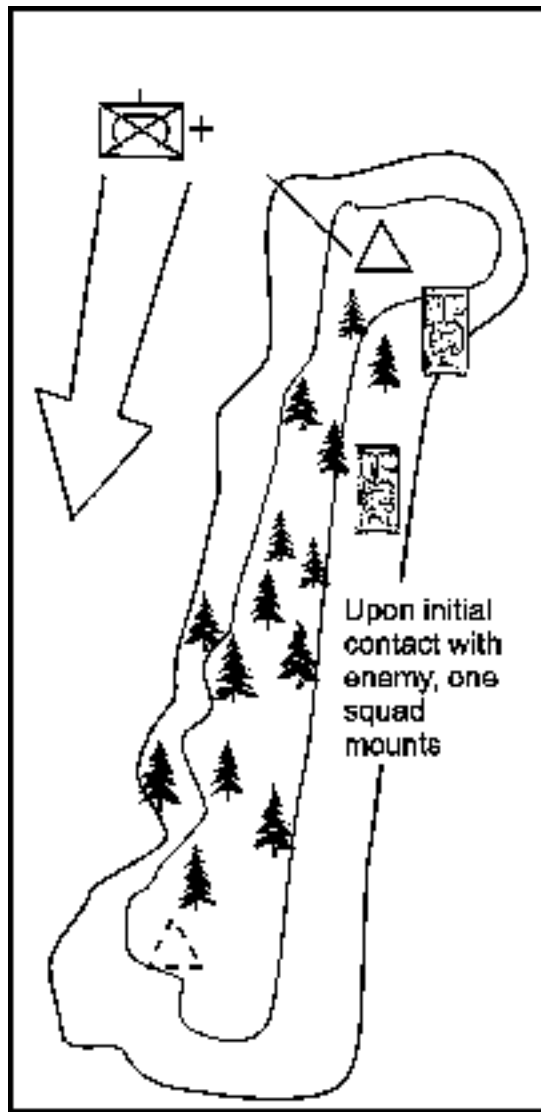

Figure 4-8A. Displacement while in contact.

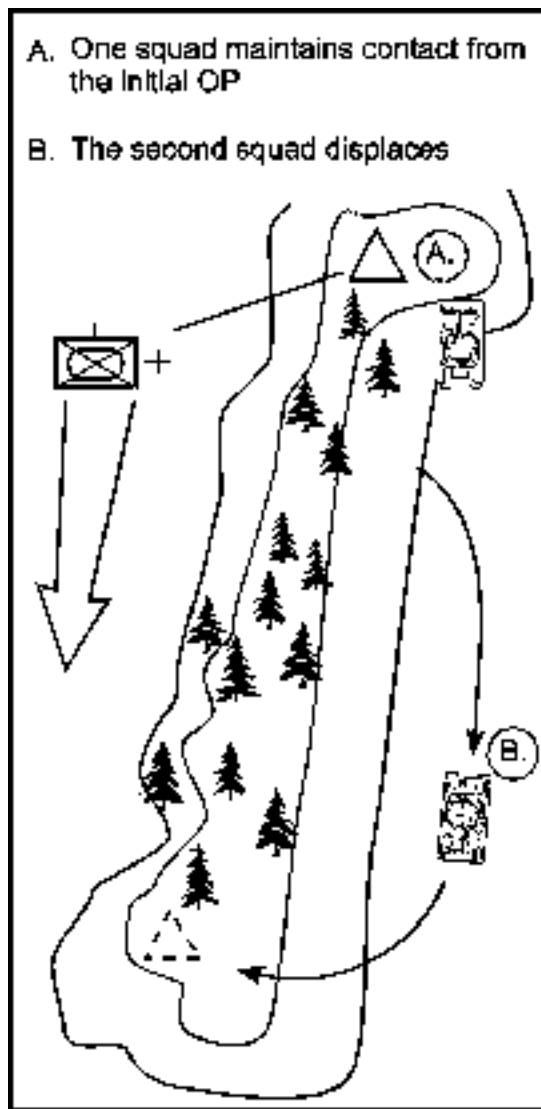

Figure 4-8B. Displacement while in contact (continued).

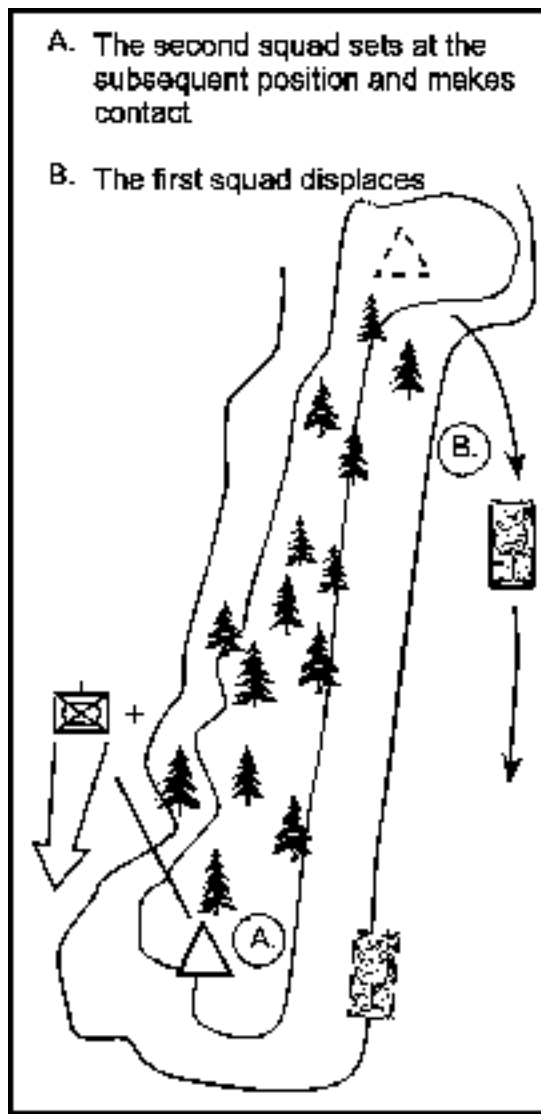

Figure 4-8C. Displacement while in contact (continued).

A third technique is a combination of the two discussed earlier. Leaving the original dismounted OP in position (with a vehicle in support, if possible), the scouts detach a vehicle or vehicle section and reposition it in depth as either a mounted or dismounted OP. This OP can be established or reoriented to maintain contact until the enemy force can be handed off to a maneuver element. This technique reduces both the time associated with moving OPs and the likelihood that any scout element will be compromised. Refer to [Figure 4-9A](#) and [4-9B](#)).

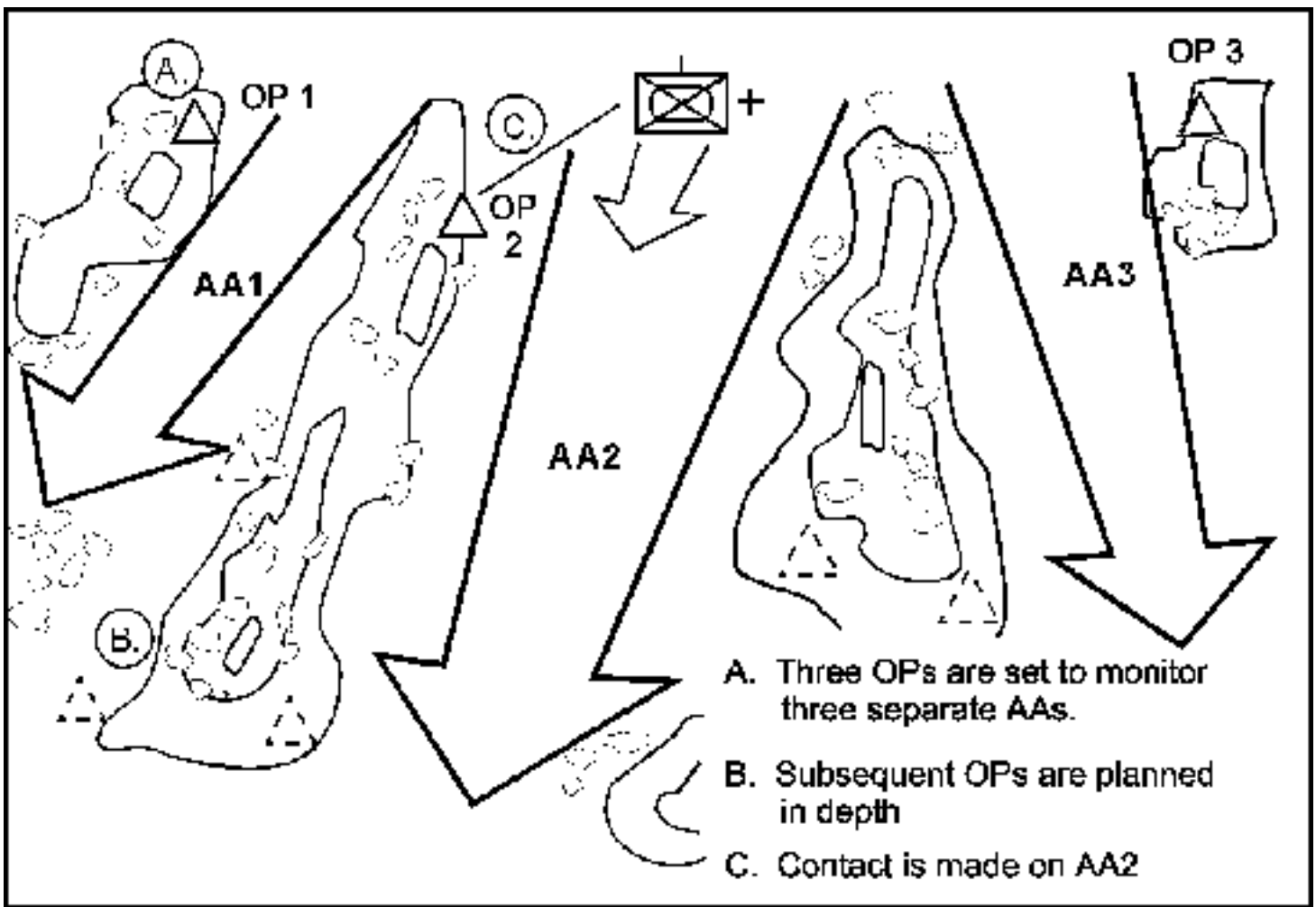

Figure 4-9a. Repositioning OPs in depth.

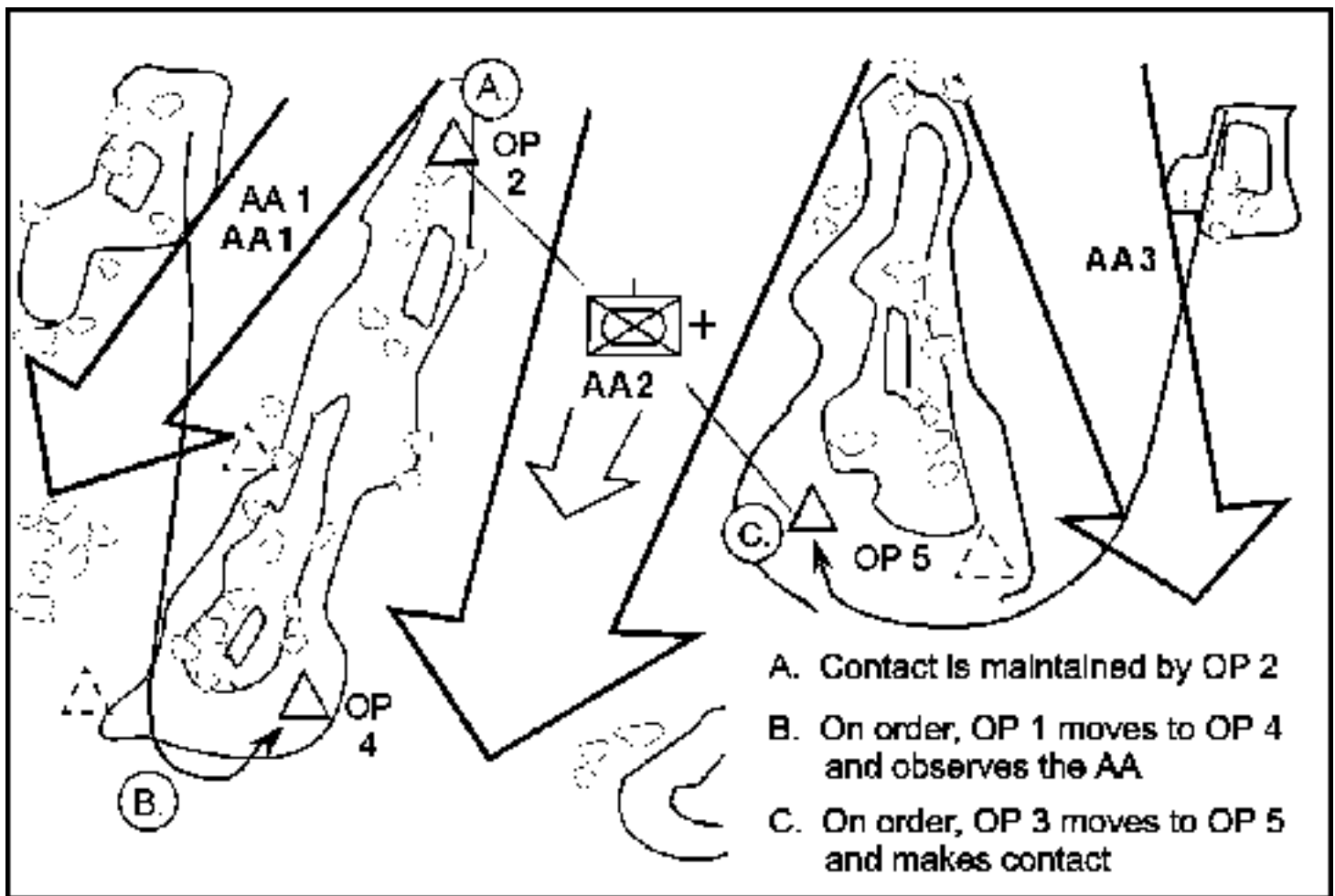

Figure 4-9b. Repositioning OPs in depth (continued).

Harass and impede

Scouts should attempt to harass and impede the enemy using indirect fire. It is difficult, however, to effectively engage a moving armored element with indirect fire. Through careful planning that focuses on expected avenues of approach, choke points, the enemy rate of march, and artillery time of flight, the platoon leader can determine trigger lines (or points) that allow the enemy to be accurately engaged.

Accurate artillery fire will have an immediate effect on the enemy main body. Formations will be disrupted as individual vehicles change speed, button up, or are destroyed or disabled. Command and control will deteriorate as vision is restricted and antennas are lost; this loss of vision and command and control will restrict the enemy's ability to spot displacing friendly forces. The enemy may also compromise his momentum and combat power if he attempts to locate the element directing the fire.

COUNTERRECONNAISSANCE TECHNIQUES

Counterreconnaissance is a directed effort to prevent visual observation or infiltration of friendly forces by enemy reconnaissance elements. It is a critical task of all cavalry or battalion scout platoon security missions. Countering the enemy's mounted reconnaissance is the first and possibly most important step in ensuring the main body can successfully execute its mission. This task is most successfully executed when it is approached as a combined arms effort at troop and battalion level.

The scout platoon plays a vital role in the battalion task force and cavalry troop counterreconnaissance fight. Although counterreconnaissance is mostly discussed in terms of battalion operations, it is equally applicable to the cavalry troop and squadron.

Planning considerations

The task force or troop concept of executing counterreconnaissance must address how the unit will accomplish the two aspects of counterreconnaissance: acquiring the enemy and then killing him. At squadron and battalion level, the S2 provides key input in this determination. He identifies where RAAs into the unit sector are located, what type of enemy reconnaissance elements might be used in the sector, and when they are most likely to move into the sector. This information is integrated into the R&S plan and is part of the unit's IPB.

At the same time, the R&S plan is not normally sufficient to provide detailed guidance for the conduct of counterreconnaissance. The commander or S3 should supplement it with a FRAGO indicating in tactical terms how elements will organize and conduct counterreconnaissance operations throughout the depth of the task force area of operations. This information should include planning considerations for the operation, including the following:

- Direct fire planning and coordination.
- Observation planning and coordination.
- Command and control.
- Battle handover.

In all counterreconnaissance operations, the goal is to kill the enemy reconnaissance forces after they have penetrated the initial screen line. The scout platoon's role in these operations will usually be to conduct a screen mission to acquire and identify enemy reconnaissance forces. This requires that the acquiring elements of the platoon be well hidden to prevent the enemy from detecting the screen line. The S3 may also task maneuver units to conduct patrols to find the enemy. In most cases, the scout platoon cannot be expected to have the capability to acquire, identify, and defeat the enemy reconnaissance by itself. Other combat elements will be tasked to fight and kill the enemy reconnaissance elements.

Organization

Several organizational options, which are described in the following paragraphs, are available to the commander or S3 to counter the enemy reconnaissance effort.

Scout platoon. This technique puts the entire burden for counterreconnaissance on the scout platoon and attached CS assets. It requires maximum use of the CS assets to acquire the enemy, freeing the scouts to perform the killing function of counterreconnaissance. The scout platoon leader places acquiring assets along the screen line and positions his designated killing teams in depth. The killing assets of the platoon occupy positions on likely enemy reconnaissance routes; however, they must be flexible to respond to enemy elements moving on other routes.

This technique requires that the platoon's sections or squads reconnoiter alternate positions and routes that permit quick repositioning once contact is made by the acquiring elements. When it is used, counterreconnaissance tasks must be prioritized in the early stages of the screen mission.

Scout and tank team. The team technique requires the close integration of a scout platoon and a tank platoon to execute counterreconnaissance tasks. The scout platoon is the acquiring element, and the tank platoon is the killing element. The scout platoon leader, as the element that makes first contact, commands the counterreconnaissance effort; the tank platoon is placed OPCON to the scout platoon. In the cavalry troop, the troop commander may control and coordinate the effort. The scouts acquire the enemy through the use of surveillance techniques. The tanks occupy a BP along likely reconnaissance avenues, but they are prepared to move to prereconnoitered alternate positions based on reports coming from the scout platoon.

This organization will be most effective when the two platoons establish a habitual relationship. It is very well suited to cavalry troop and squadron counterreconnaissance operations because it mirrors the regimental cavalry troop organization. It can also be effective for execution by a battalion scout platoon and a designated tank platoon. Refer to [Figure 4-10](#).

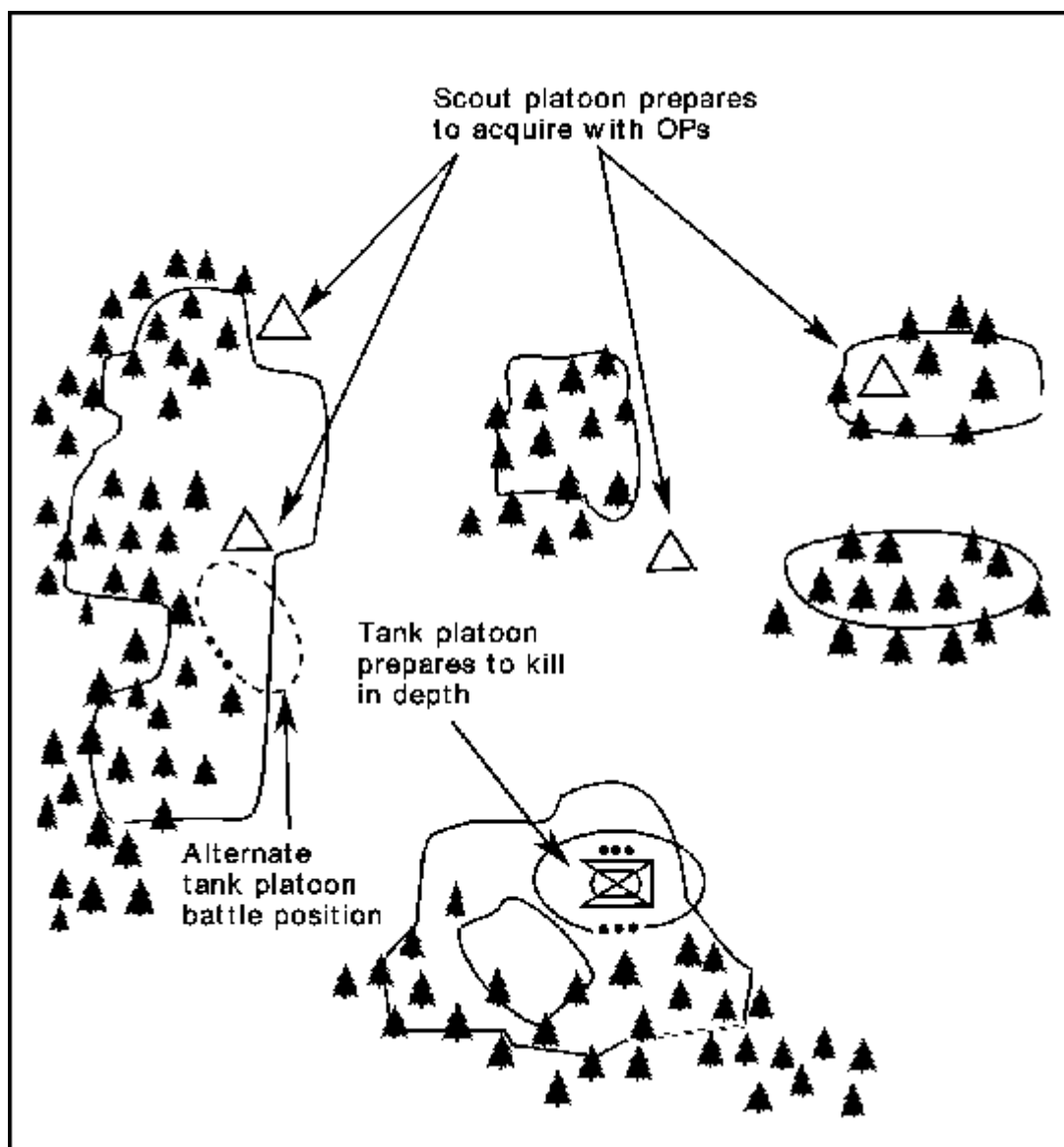

Figure 4-10. Scout and tank team counterreconnaissance array.

Scout and company team. In this technique, a combined arms task force uses a company team with an attached or OPCON scout platoon to execute counterreconnaissance and security operations. The company team commander controls the security effort. The scout platoon is the primary acquiring element, but it can be supplemented with infantry assets from the company team and CS assets from the battalion. The commander uses all other assets as the killing element.

This is the most robust counterreconnaissance technique and has the combat power to be very effective. It also has organic CSS assets, making service support operations quicker and more responsive. Major disadvantages of this technique are the combat power it diverts from the main battle area (MBA) and the execution problems that may result if the scouts and the killing elements have not trained together. See [Figure 4-11](#).

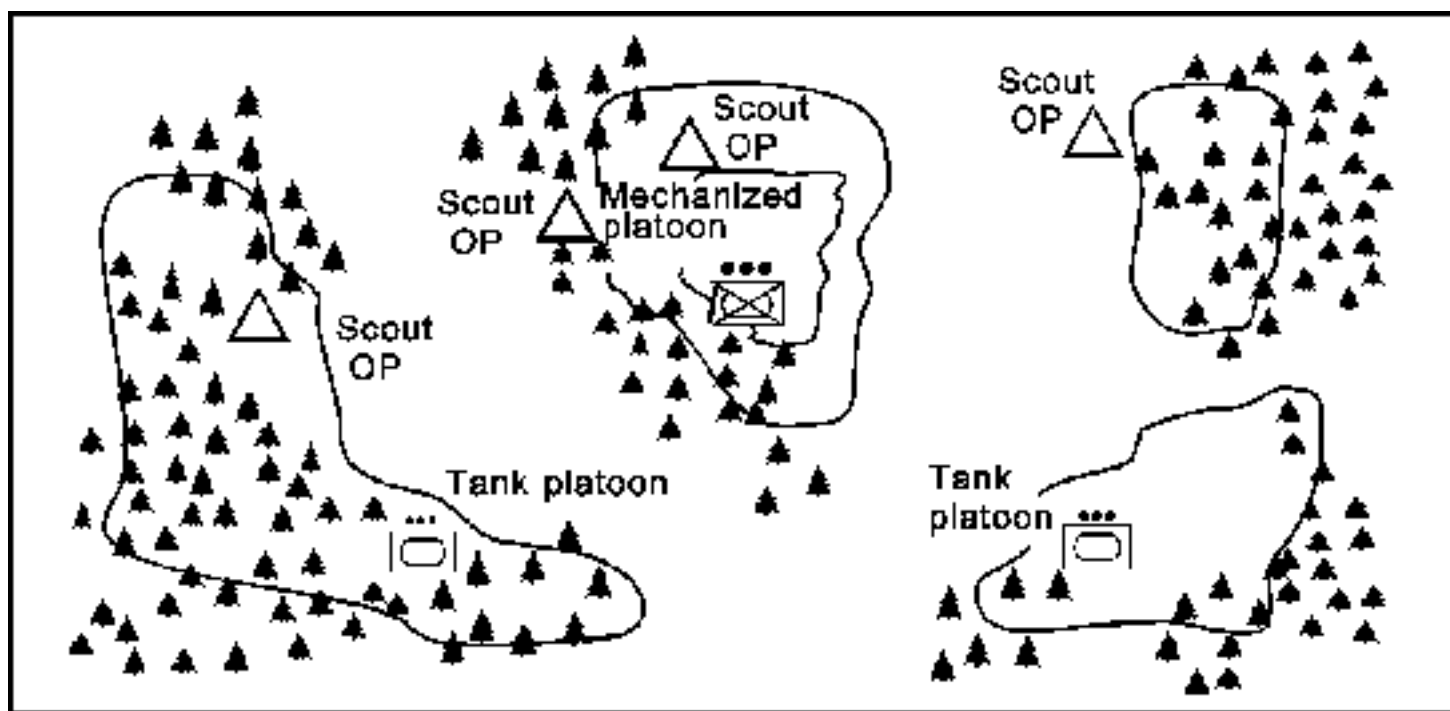

Figure 4-11. Scout and company team counterreconnaissance array.

When using this technique, the company team may eventually conduct a rearward passage of lines and become the task force reserve once the counterreconnaissance effort is complete. The scout platoon, however, will remain on the screen line and revert to task force control.

EXAMPLE OF A CAVALRY SCOUT PLATOON SCREEN OPERATION

The cavalry scout platoon normally screens as part of a troop operation. This example focuses on 1st Platoon, Troop B, operating as part of a regimental cavalry squadron (see [Figure 4-12](#)). The troop commander has been assigned the mission to screen in his sector along PL BOB and between PL BOB

and PL SAM. The troop will hand over enemy contact as the enemy crosses PL SAM. The troop commander decides to screen with his two scout platoons on line and his tank platoons in depth behind the scout platoons.

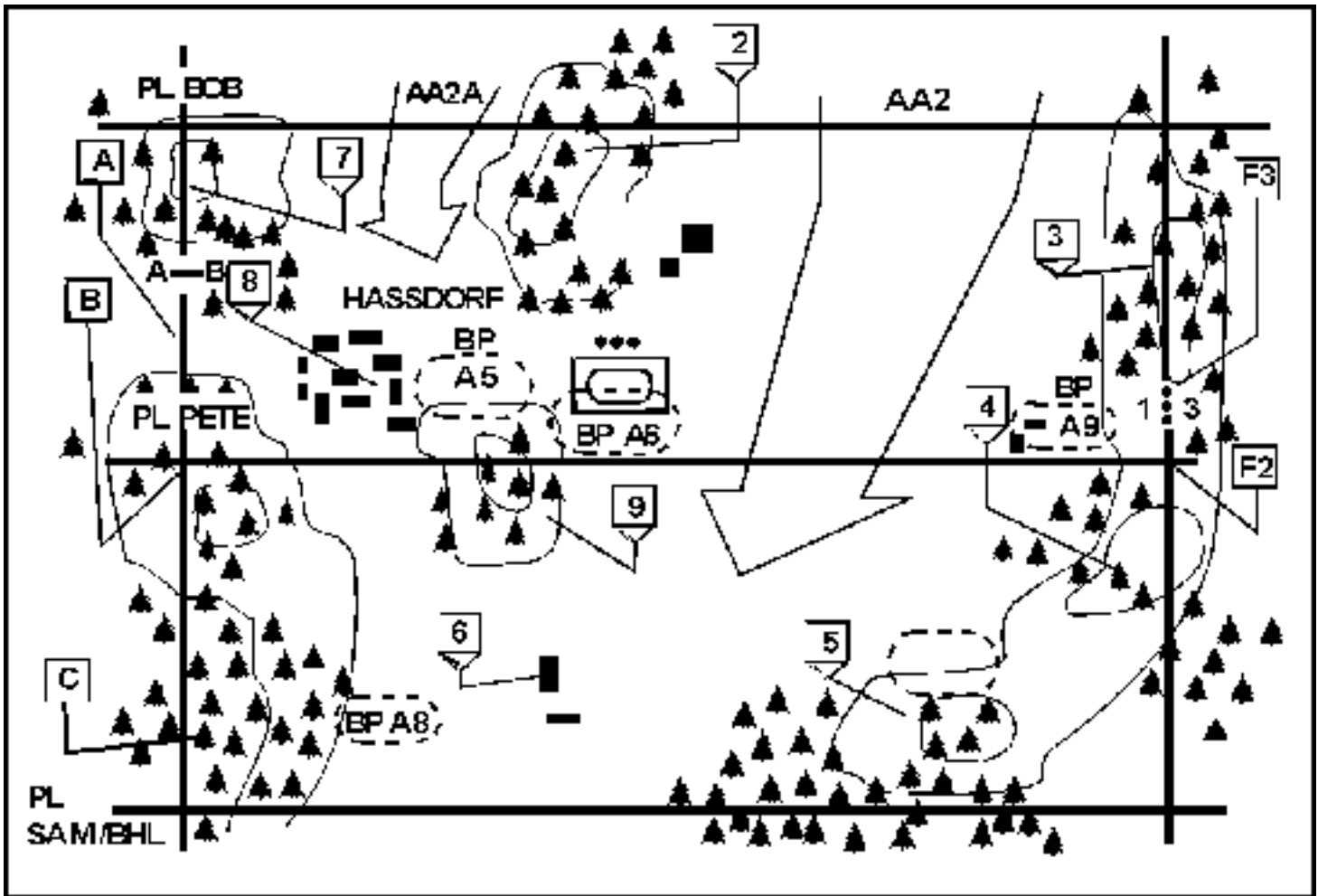

Figure 4-12. Troop screen concept.

The primary focus of the 1st Platoon is on acquiring enemy main body elements moving along avenue of approach 2 or 2A (AA2 and AA2A in the figure). The platoon will also locate as much enemy reconnaissance as possible. Because of the width of the sector, the scout platoons have permission to engage enemy reconnaissance patrols smaller than platoon size, but only under favorable conditions. The tank platoon's primary task is to destroy enemy reconnaissance elements of platoon size or larger. In the 1st Platoon's area of operations, the 2d Platoon (tank) has been positioned in BP A6 and is prepared to occupy any other BP on order.

With his troop commander's guidance, the 1st Platoon leader evaluates the resources available to accomplish his tasks. Because there is no assigned time limit to the mission, he plans for long-duration OPs. This consideration leads him to select a three-section organization. He places one section to observe AA2A from OP A and applies redundancy along the most dangerous avenue, AA2, by positioning sections at OPs C and E (see [Figure 4-13](#)). Positioning of these OPs is critical. A map reconnaissance indicates that RAAs are probably located along the platoon's boundaries and through the wooded area in the center of the platoon screen (in the vicinity of checkpoints 7, 2, and 3).

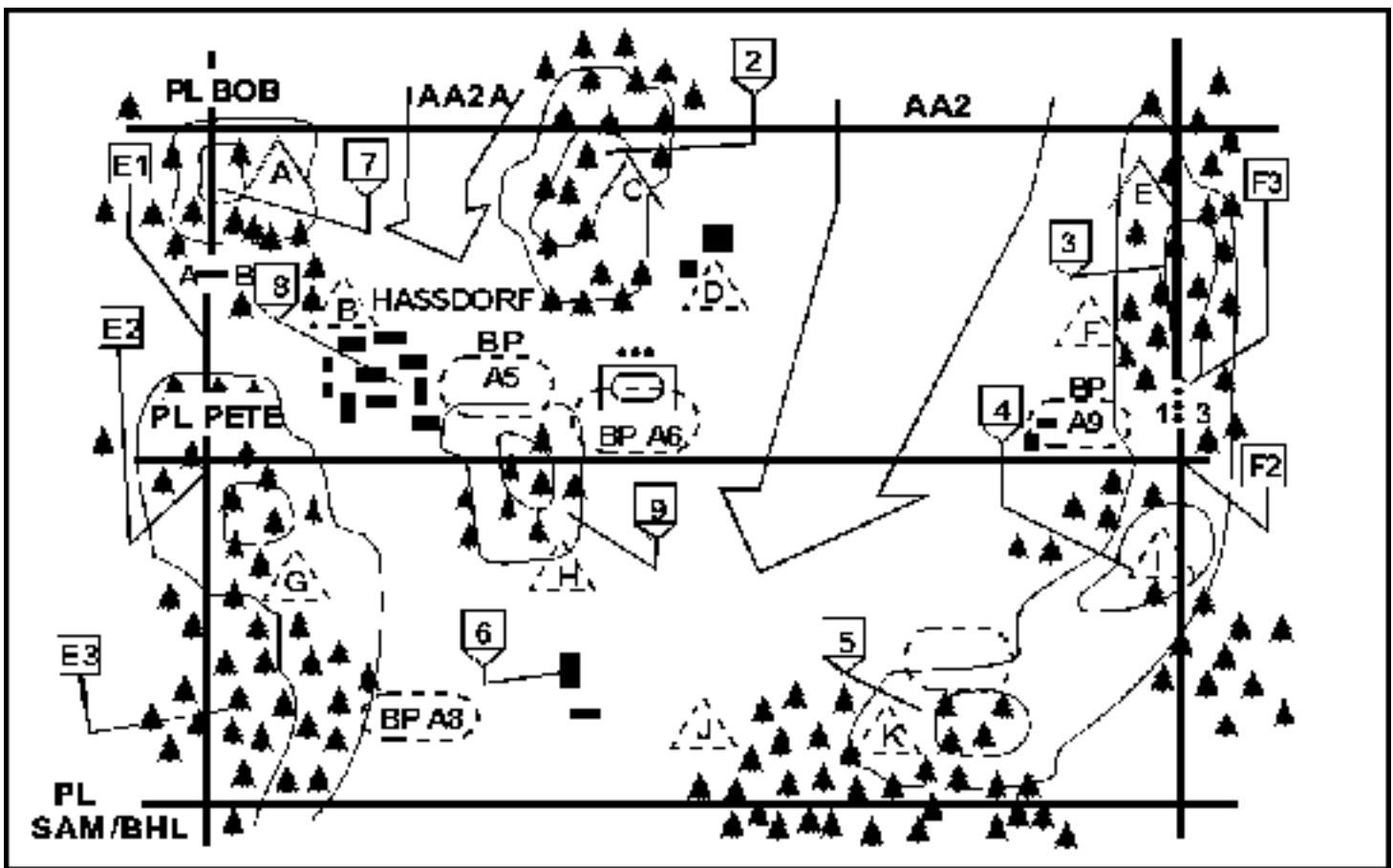

Figure 4-13. Scout dispositions.

Careful positioning of the OPs will allow continuous coverage of AA2 and AA2A and some coverage of the RAAs. The platoon leader plans to conduct patrols for further surveillance of the RAAs. In addition to his primary positions, the platoon leader plans alternate and subsequent OPs throughout the depth of his sector. He selects these positions based on his requirements to reposition if an OP is compromised and to maintain contact with the main body throughout the depth of his sector (see [Figure 4-13](#)).

If time permits, the platoon leader will report all his planned positions to the troop TOC. As a minimum, he will send the exact locations of the initial positions.

As the scout sections arrive at their assigned positions (OPs A, C, and E), they adjust them to best meet the intent of the platoon leader. Upon arriving, the sections report "SET"; after the OP is completely installed, they report "ESTABLISHED." Once established, the scout sections begin executing patrols in accordance with the platoon patrol plan.

After a period of time, OP A reports contact with an enemy reconnaissance patrol consisting of two BRDMs (see [Figure 4-14](#)). Based on the platoon leader's guidance, the CFVs supporting the OP engage and destroy the enemy vehicles. The scouts send the appropriate reports and, with the platoon leader's permission, displace to alternate OP B. Later, scouts at OP C also make contact with an enemy reconnaissance patrol, take the same actions that occurred at OP A, and reposition to their alternate site, OP D.

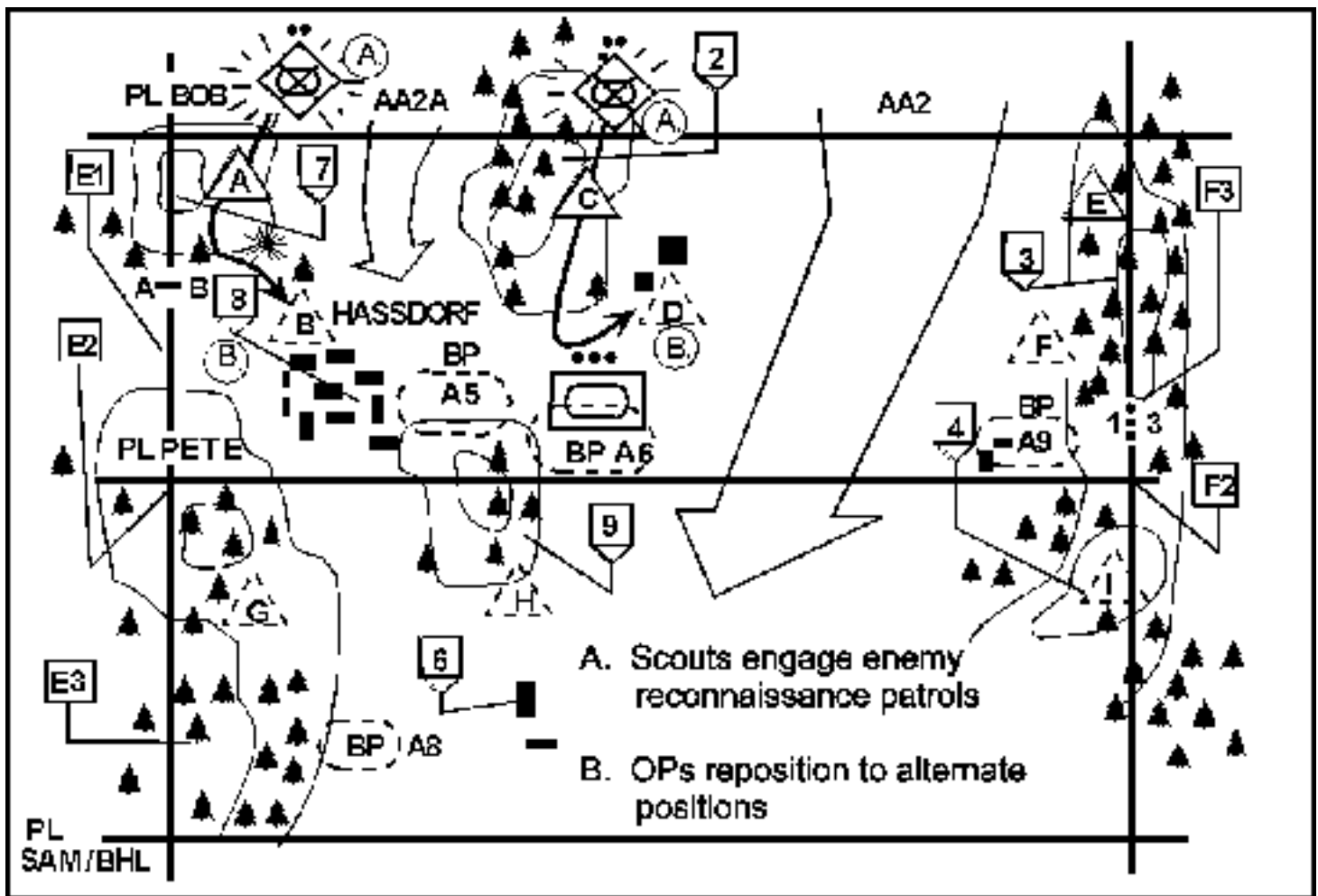

Figure 4-14. Scouts engaging reconnaissance patrols.

The scout sections that repositioned report set and established as they occupy their alternate OPs (B and D). After a period of time, the section at OP D reports contact with three BMPs and a BRDM, moving south just west of AA2 (see [Figure 4-15](#)). It also reports artillery striking in the vicinity of OP C, the position it had vacated. Based on the platoon leader's guidance, the scouts take no action, remain hidden, and continue to report. The platoon leader forwards the report to the troop commander and receives instructions to coordinate target handover with the 2d Platoon in BP A6.

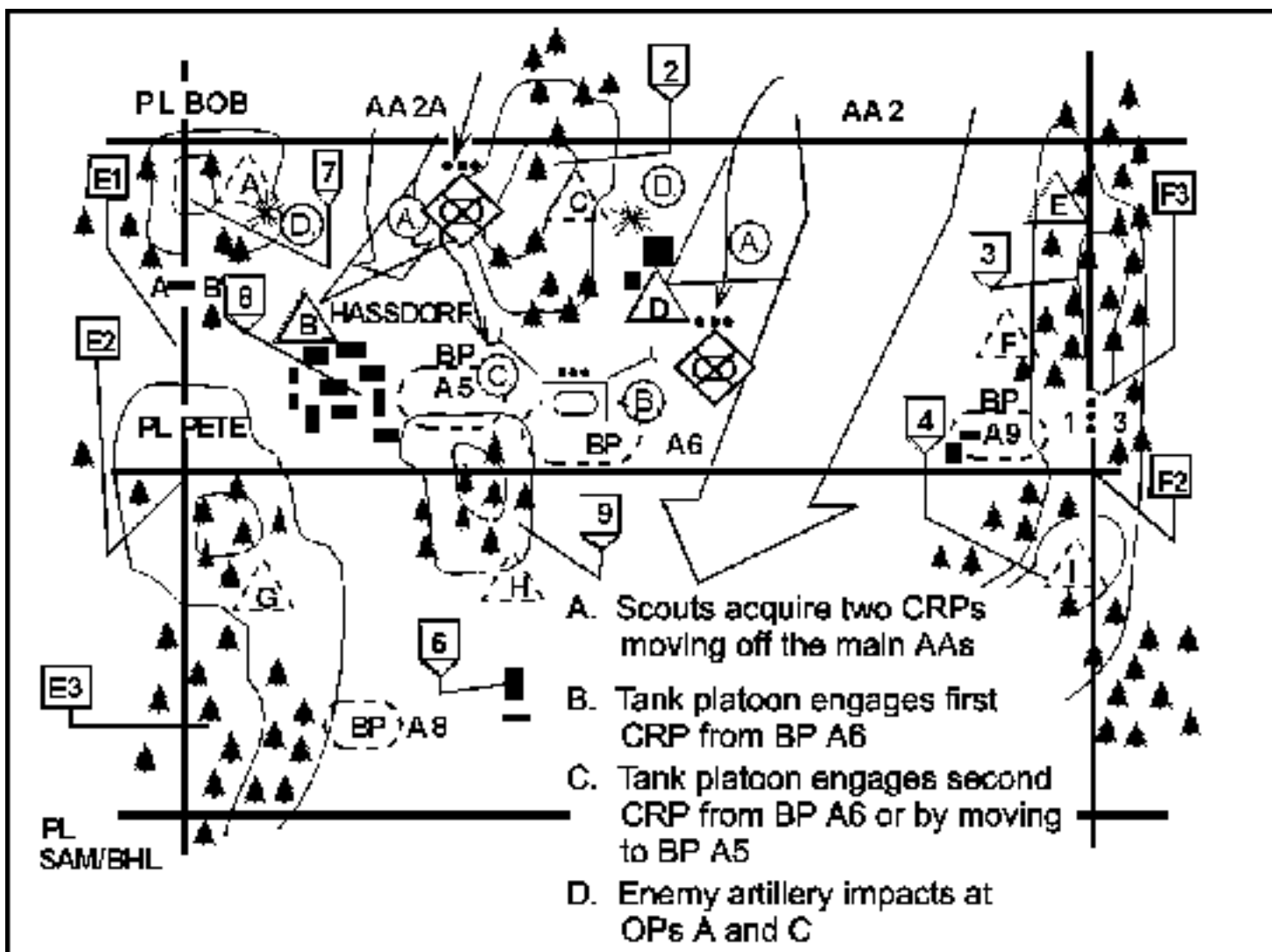

Figure 4-15. Scouts acquiring combat reconnaissance patrols (CRP); tanks killing CRPs.

A short time later, the scouts in OP B report artillery impact in the vicinity of OP A and then contact with two BMPs and a tank, moving south just east of AA2A. The tank platoon engages the first enemy contact from BP A6 and destroys it.

Having monitored the developing enemy situation, the troop commander may order the tank platoon to quickly reposition to BP A5. The tank platoon coordinates with the scout platoon leader, moves to the new BP if necessary, and engages and destroys the second enemy platoon.

Having engaged a significant number of enemy elements from BP A6 and/or BP A5, the tank platoon is ordered by the troop commander to reposition to BP A8. As that occurs, the scout section at OP E identifies the first element of the enemy main body, a company-size element. The platoon leader decides to take a risk along AA2A by ordering the displacement of OP B to OP H. This gives him additional depth along AA2 and will make it easier for the platoon to maintain contact with the enemy main body (see [Figure 4-16](#)).

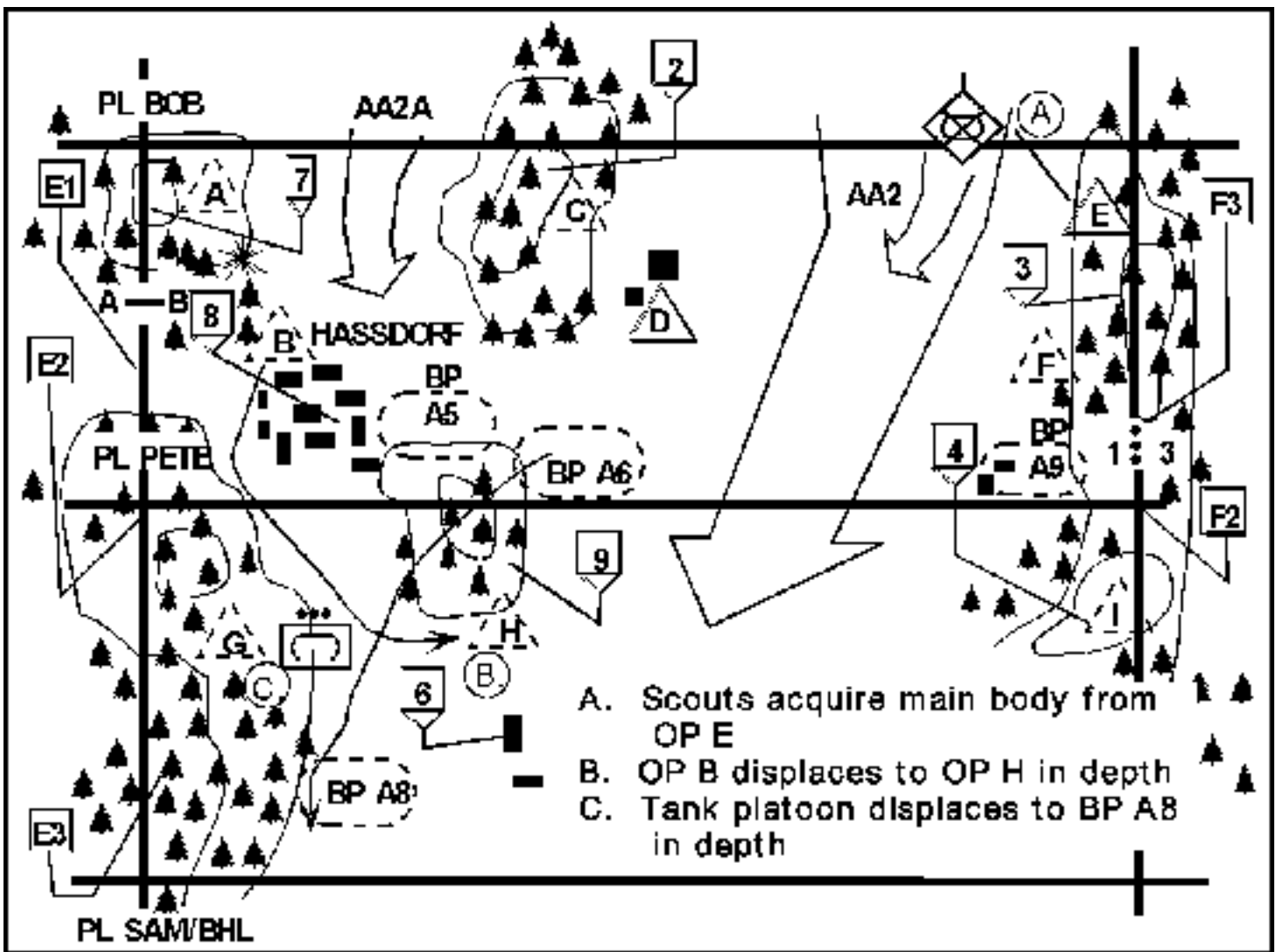

Figure 4-16. Scouts acquiring enemy main body.

The scouts at OP E maintain contact with the enemy main body until it can be observed by the scouts at OP D (see [Figure 4-17](#)). Once that occurs, the two OPs conduct target handoff, and the scouts at OP E begin to displace in depth to OP J. The scouts at OP D begin to harass the enemy main body by calling for indirect fire. This fire not only breaks up the momentum of the main body, but also helps cover the displacement of OP E. OP D also reports enemy artillery impact in the vicinity of BP A6. The section formerly at OP B now reports set at OP H. Eavesdropping on the troop net, the scout platoon learns that 2d Platoon is set at BP A8.

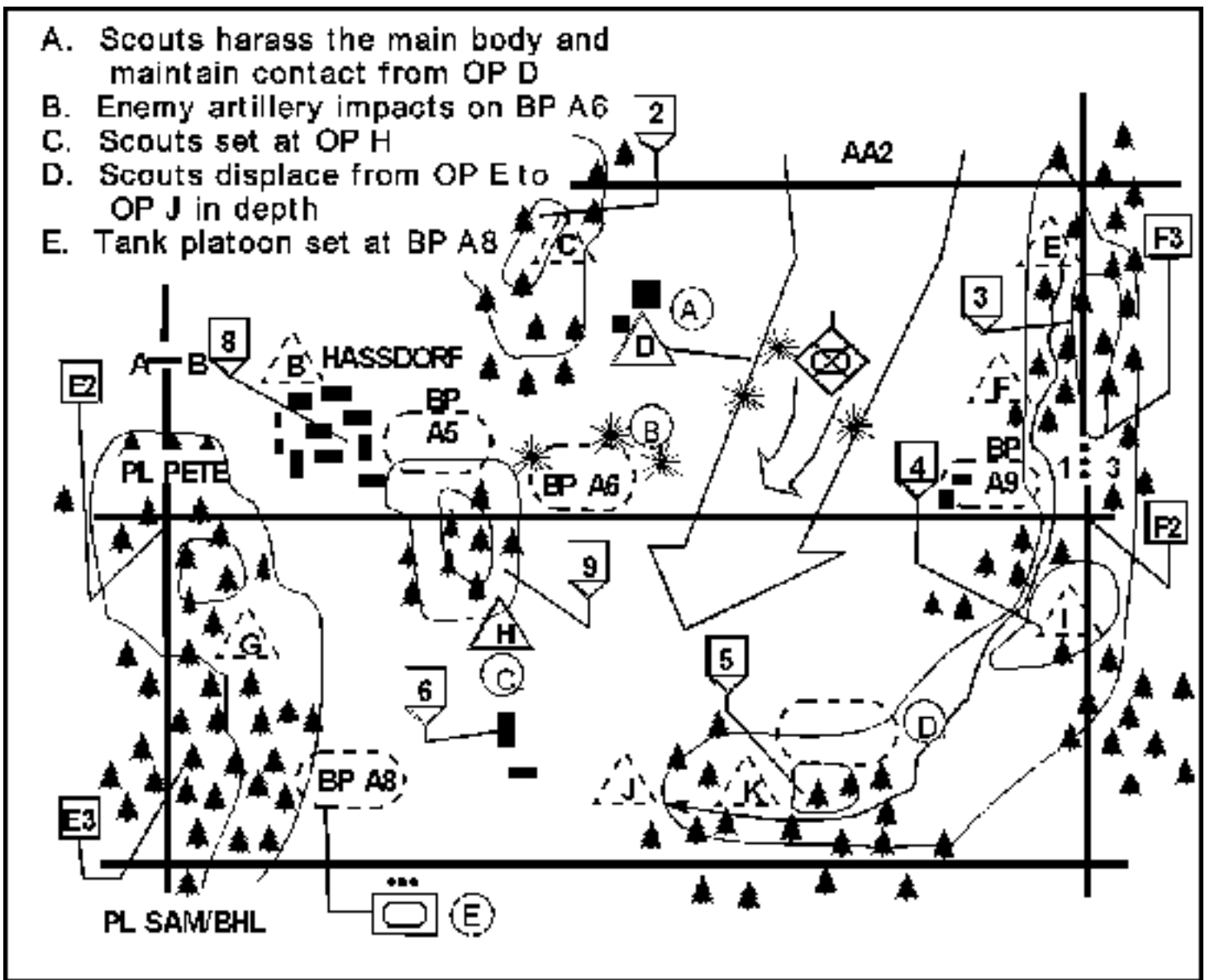

Figure 4-17. Scouts harassing enemy main body.

As the enemy main body moves down AA2, target handover occurs between OP D and OP H (see [Figure 4-18](#)). OP H maintains contact with the enemy and continues to harass him with indirect fire. As the enemy main body continues to move, it is engaged with direct fire by the tank platoon in BP A8. These combined fires disrupt and significantly slow the enemy main body. Meanwhile, the scouts at OP D displace laterally toward the Troop A area to conduct rearward passage. Scouts also report set at OP J and begin coordinating battle handover to the friendly unit south of PL SAM.

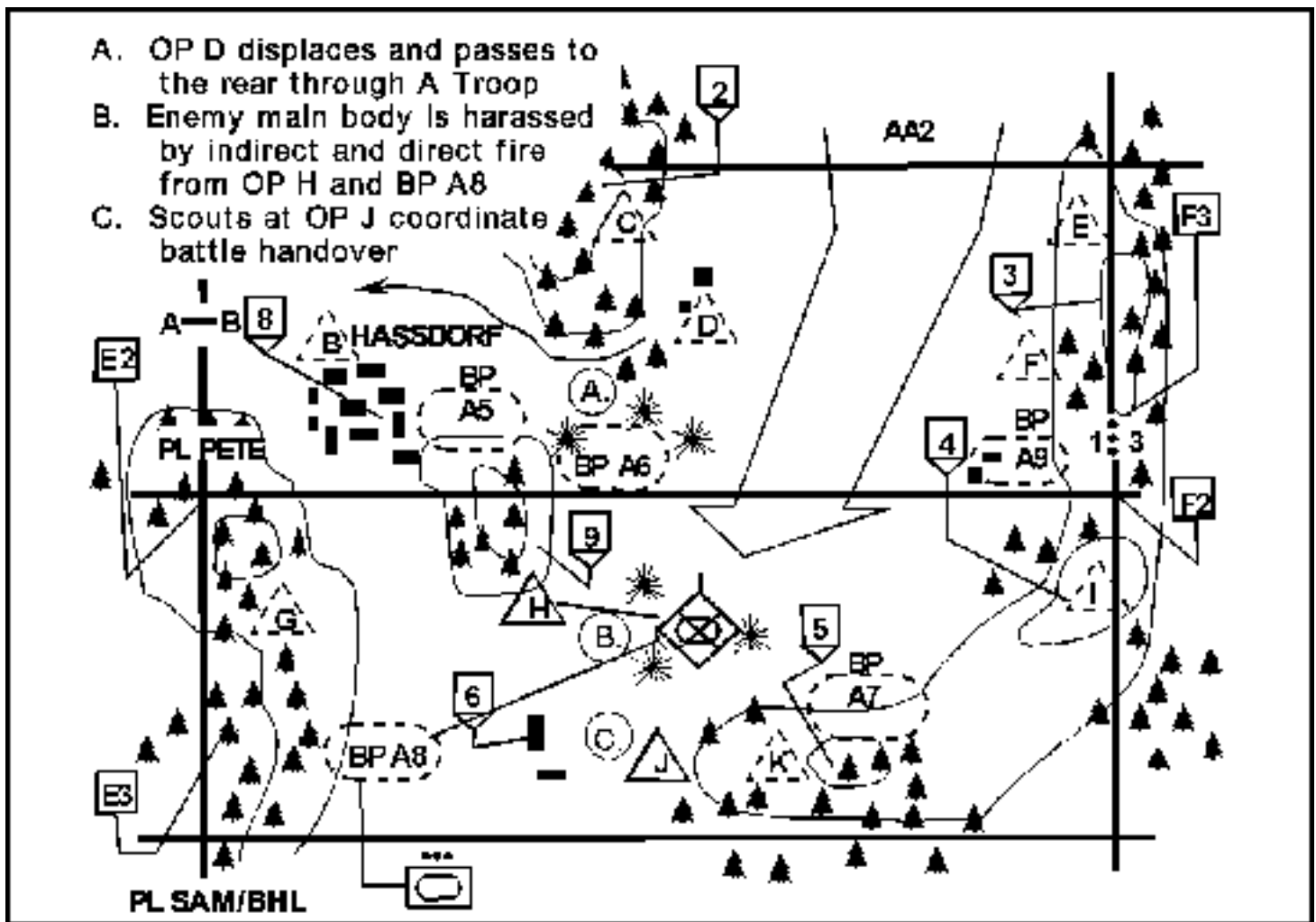

Figure 4-18. Tanks and scouts engaging enemy main body.

After the initial engagement of the enemy main body, the tank platoon displaces laterally toward Troop A to conduct a rearward passage of lines (see [Figure 4-19](#)). OP H conducts target handover with OP J and also moves toward Troop A. OP J maintains contact with the moving enemy main body until battle handover with the friendly unit to the south is complete. The scouts at OP J then moves east to pass to the rear.

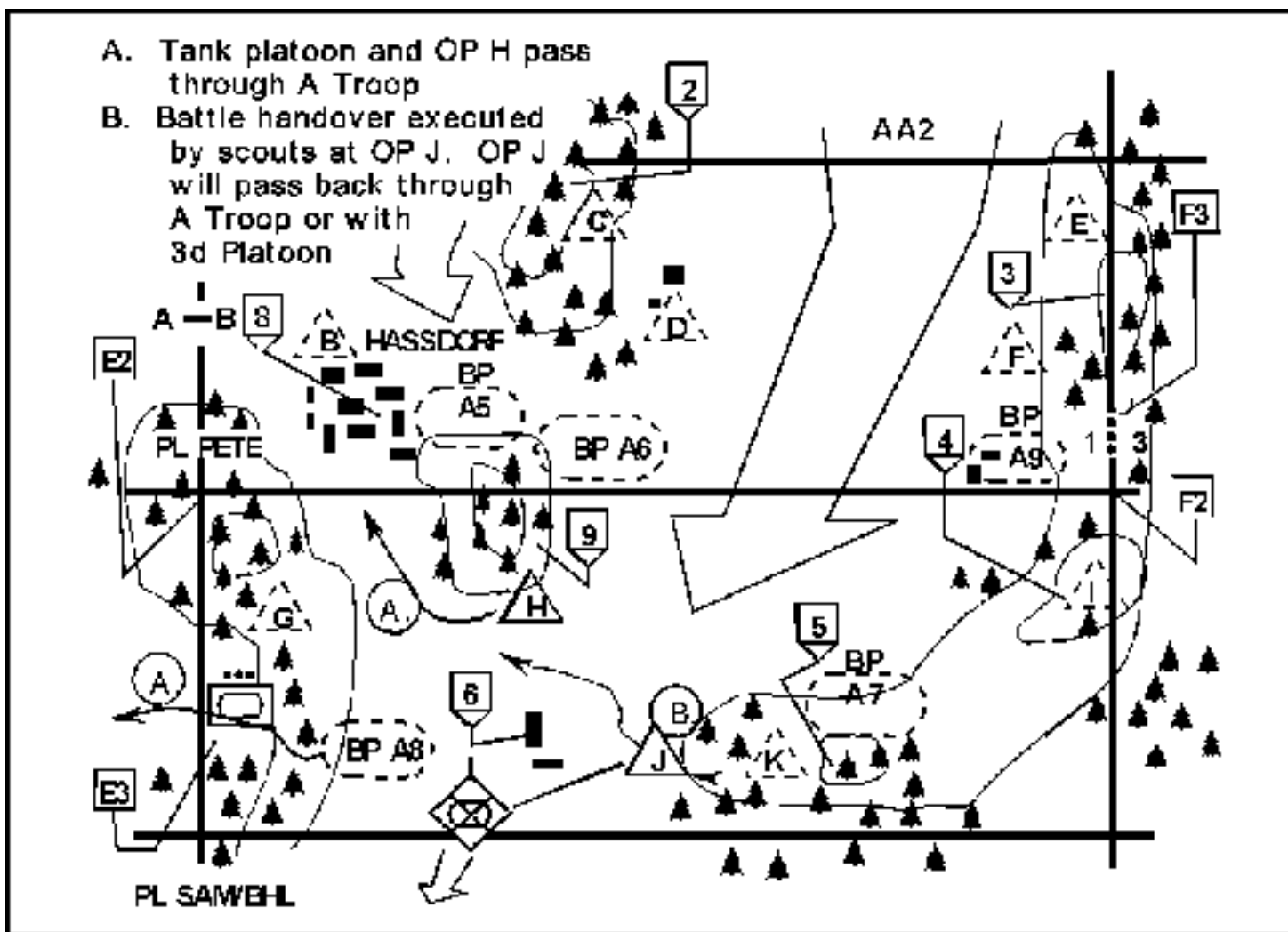

Figure 4-19. Scouts executing battle handover to incoming unit.

SECTION 3 — AREA SECURITY OPERATIONS

Area security operations are designed to protect specific critical and vulnerable assets or terrain from enemy observation and direct fire. They can involve escorting friendly convoys; protecting critical points such as bridges, command and control installations, or other key and vulnerable sites; or participating in protection of large areas such as airfields. They are normally performed when conventional security or combat operations are not appropriate to the situation. The scout platoon may perform area security operations as part of a larger force or as an independent platoon mission.

CONVOY AND ROUTE SECURITY

Convoy or route security missions are performed by company teams, cavalry troops, and larger organizations. Convoy security provides protection for a specific convoy. Route security aims at securing a specific route for a designated period of time, during which multiple convoys may be using the route. These missions include numerous tasks for elements such as escort, reconnaissance, and combat reaction forces (see [Figure 4-20](#)). These tasks become missions for the subordinate units. The scout platoon is particularly well suited for route reconnaissance and outposting missions and may perform convoy escort as well. The size of the unit performing the convoy or route security operation is dependent on a number

of factors, including the size of the convoy, the terrain, and the length of the route.

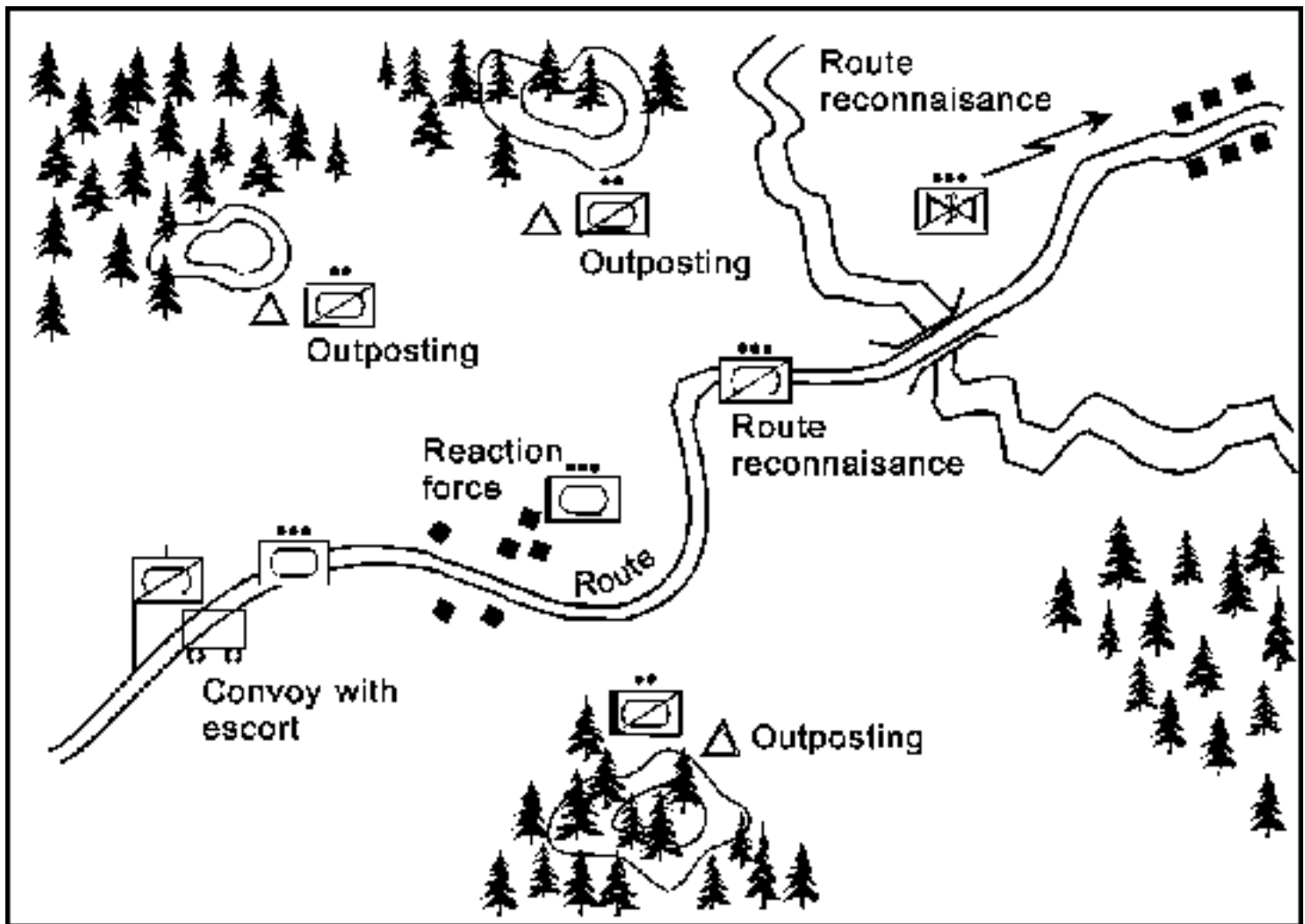

Figure 4-20. Cavalry troop conducting convoy security mission.

Route reconnaissance.

When route reconnaissance is conducted as part of a route security operation, it is done in the same manner as discussed in [Chapter 3](#) of this manual. In this mission, scouts focus on the trafficability of the route and on enemy forces that might influence the route. The scout platoon must plan to call for engineer assets to assist in breaching point-type obstacles. Command-detonated devices are a major threat during route reconnaissance.

Outposting

Outposting is a technique used during route security to screen the route after it has been reconnoitered. Its use is similar to the technique for reconnaissance operations covering lateral and boundary routes discussed in [Chapter 8](#) of this manual. Outposting as part of route security, however, is generally done by all elements of the platoon for the specific purpose of helping to secure a route or convoy. It involves employing OPs on critical portions of the route or on key avenues of approach to the route to provide early warning of enemy elements attempting to interdict the route or convoy.

Outposting differs from a conventional screen in that the outposts are oriented on the route rather than on the friendly main body. Normally, the outposting element follows the element that is executing the route

reconnaissance (see [Figure 4-21](#)). Outposts have a limited ability to destroy small enemy forces attempting to influence the route. Their primary purpose is to acquire the enemy and then to direct the employment of reaction forces or indirect fire to destroy him.

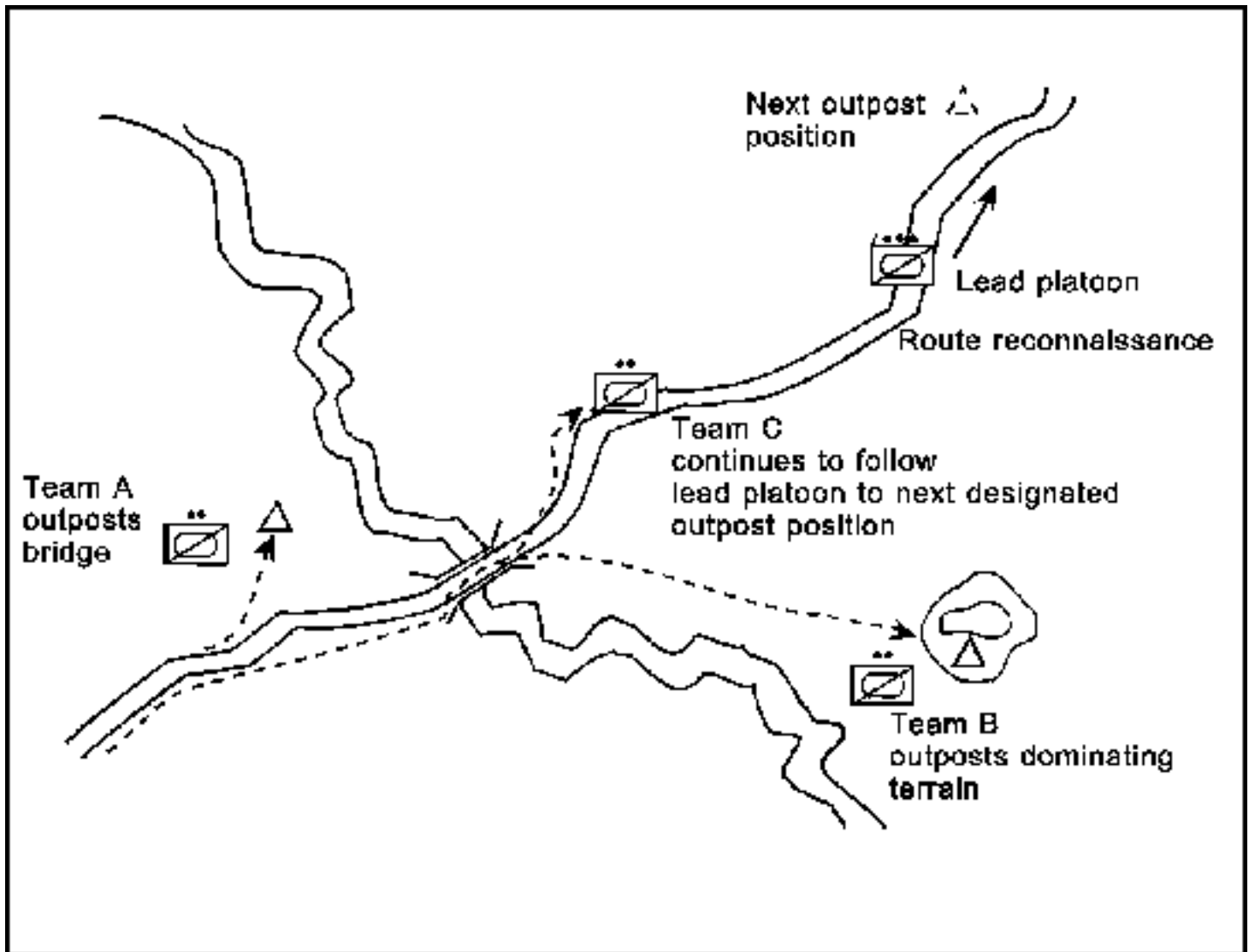

Figure 4-21. Cavalry scout platoon outposting a route.

Convoy escort

The scout platoon may perform a convoy escort mission either independently or as part of a larger unit's convoy security mission. The convoy escort mission requires that the platoon provide a convoy with close-in protection from direct fire. The platoon can protect 5 to 10 convoy vehicles per escort vehicle. These vehicles can be military CSS or command and control vehicles or civilian trucks or buses. CFV-equipped platoons are better suited to this mission than are HMMWV platoons because of their firepower and the armor protection they provide against direct fire, indirect fire, and mines. Leaders must carefully evaluate the threat before assigning a convoy escort mission to HMMWV-equipped scout platoons. The following considerations apply during convoy escort operations.

Command and control. Command and control is especially critical during convoy escort because of the task organization inherent to the mission. When the scout platoon is executing the escort mission, it operates under the control of the convoy commander. The relationship between the scout platoon and the

convoy commander must provide for unity of command and effort if combat operations are required during the course of the mission.

The platoon leader must ensure that a complete OPORD is issued to all vehicle commanders in the convoy prior to execution of the mission. This is vital because the convoy may itself be task organized from a variety of units and because many of the vehicles may not have tactical radios. The order should follow the standard five-paragraph OPORD format, with special emphasis on the following subjects:

- Order of march.
- Actions on contact.
- Chain of command.
- Communications and signals.
- Actions on vehicle breakdown.
- Actions at a halt.
- Route of march (this should include a sketch for each vehicle commander).

Tactical disposition. Security during convoy escort missions must be in all directions and throughout the length of the convoy. This requires that the elements of the scout platoon and any combat or CS attachments be dispersed throughout the convoy formation. Engineer assets should be located toward the front to respond to obstacles; the fire support team (FIST) or COLT should be located near the platoon leader.

The platoon will normally use the column formation due to its inherent speed and ease of movement (see [Figures 4-22](#) and [4-23](#)). If a HMMWV unit is used as the escort, a tracked armored vehicle should be attached to lead the convoy whenever possible because of its superior protection against mines.

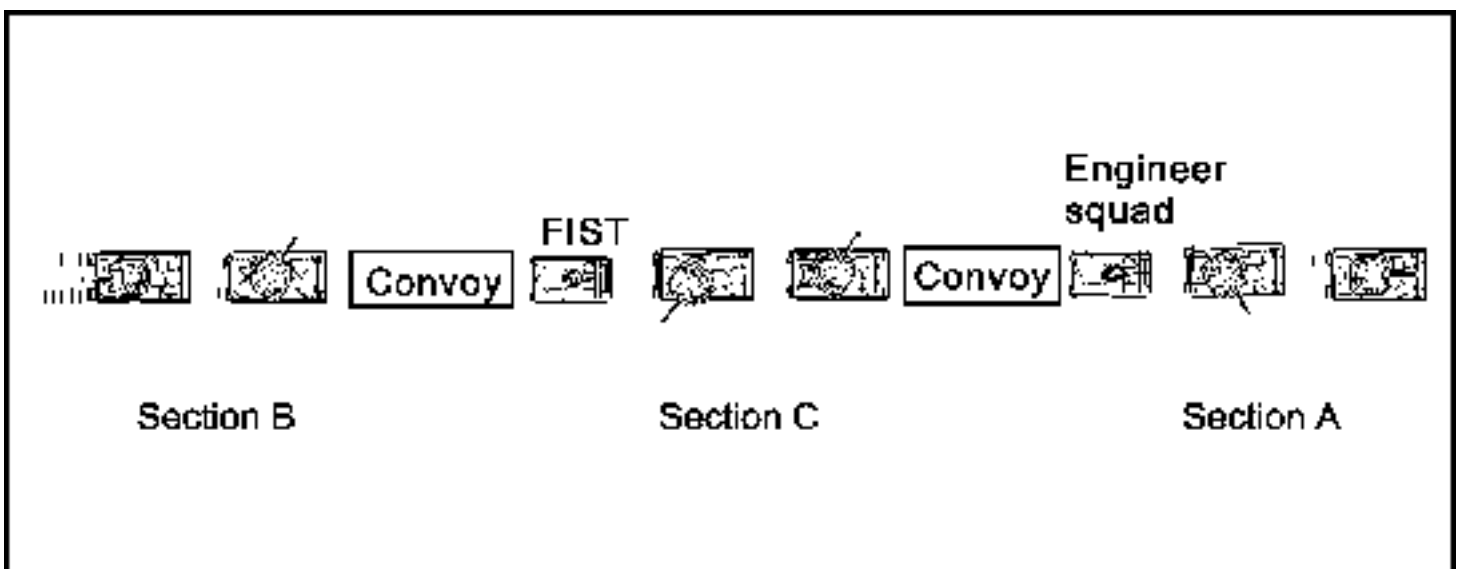

Figure 4-22. CFV scout platoon escorting a convoy.

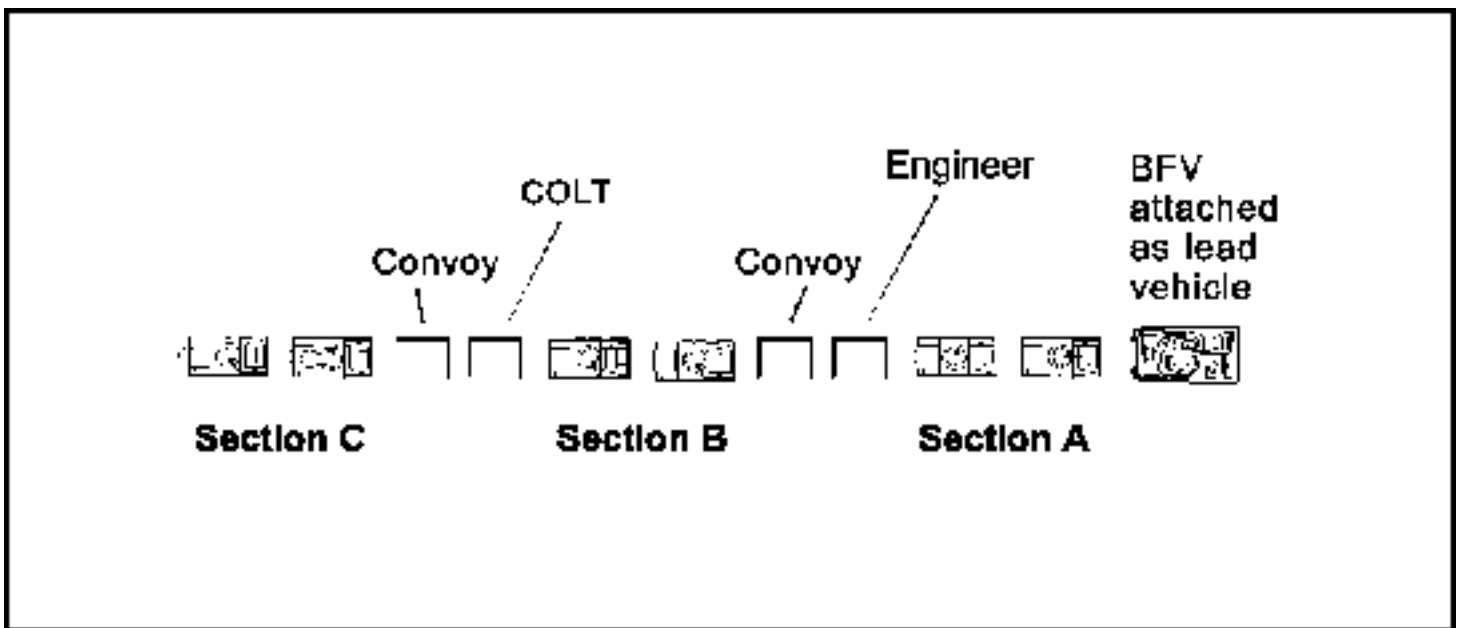

Figure 4-23. HMMWV scout platoon escorting a convoy.

Actions at an ambush. Ambush is one of the most effective ways to interdict a convoy and is therefore a threat the convoy escort must be prepared to counter. Reaction to an ambush must be quick, overwhelming, and decisive. It must be executed as a drill by all escort and convoy elements, with care taken to avoid fratricide. The following actions should be included in the convoy escort drill:

- Upon detection of an enemy force, escort vehicles action toward the enemy. They seek covered positions between the convoy and the enemy and suppress the enemy with the highest possible volume of fire. They send appropriate contact reports to higher headquarters (see [Figure 4-24A](#)).

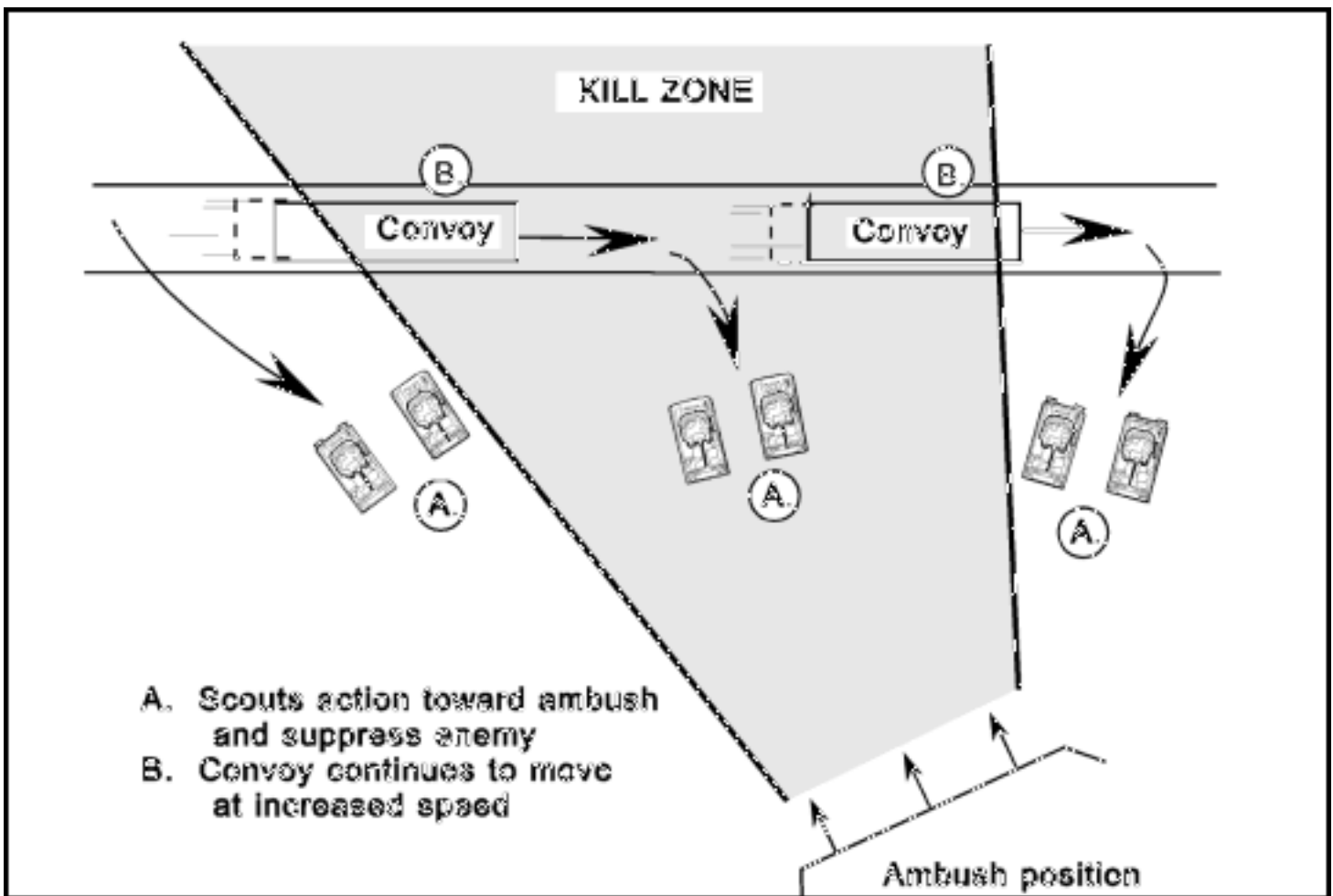

Figure 4-24A. Convoy escort actioning toward ambush.

NOTE: In some situations, elements of the escort force will be required to remain with the convoy main body. This is especially true when the convoy comprises mainly nonmilitary elements, such as nongovernmental organizations (NGO) or local civilian agencies. In addition to being unarmed in most cases, these elements will usually lack communications capabilities, making it difficult for escort elements to link back up with the main body.

- The convoy commander retains control of the convoy vehicles and maintains radio contact with the security force while moving the convoy on the route at the highest possible speed.
- Convoy vehicles, if armed, may return fire only until the escort has imposed itself between the convoy and the enemy.
- Any damaged or disabled vehicles are abandoned and pushed off the route (see [Figure 4-24B](#)).
- The escort leader (scout platoon leader) submits spot reports. If necessary, he requests reinforcement and calls for and directs indirect fires and air support if they are available.
- Once the convoy is clear of the kill zone, the escort chooses one of the following COAs based on the composition of the escort and the strength of the enemy force:
 - Continue to suppress the enemy while combat reaction forces move to support (see [Figure 4-25A](#)).
 - Assault the enemy (see [Figure 4-25B](#)).
 - Break contact and move out of the kill zone (as illustrated in [Figure 4-25C](#)).

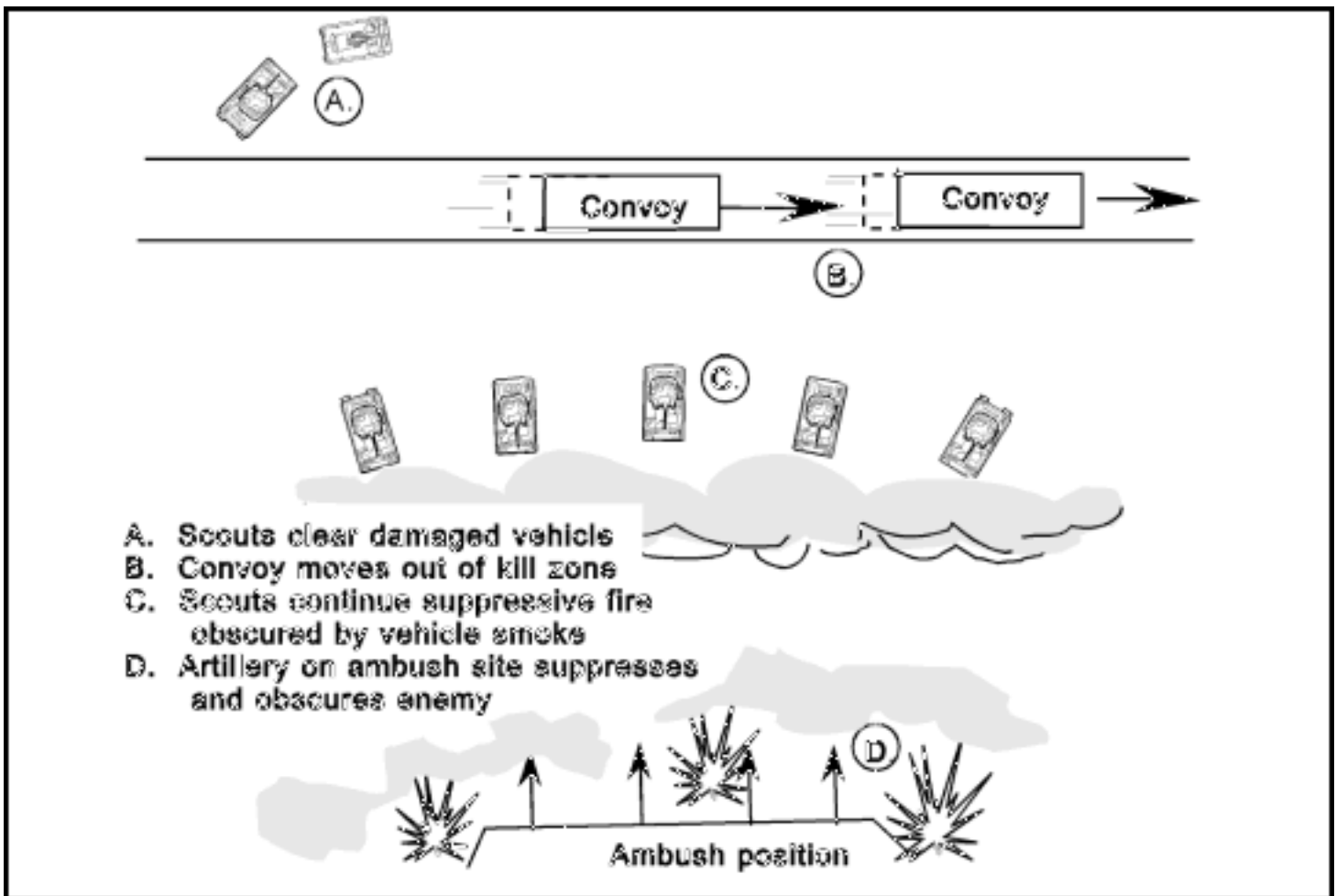

Figure 4-24B. Convoy continuing to move out of kill zone.

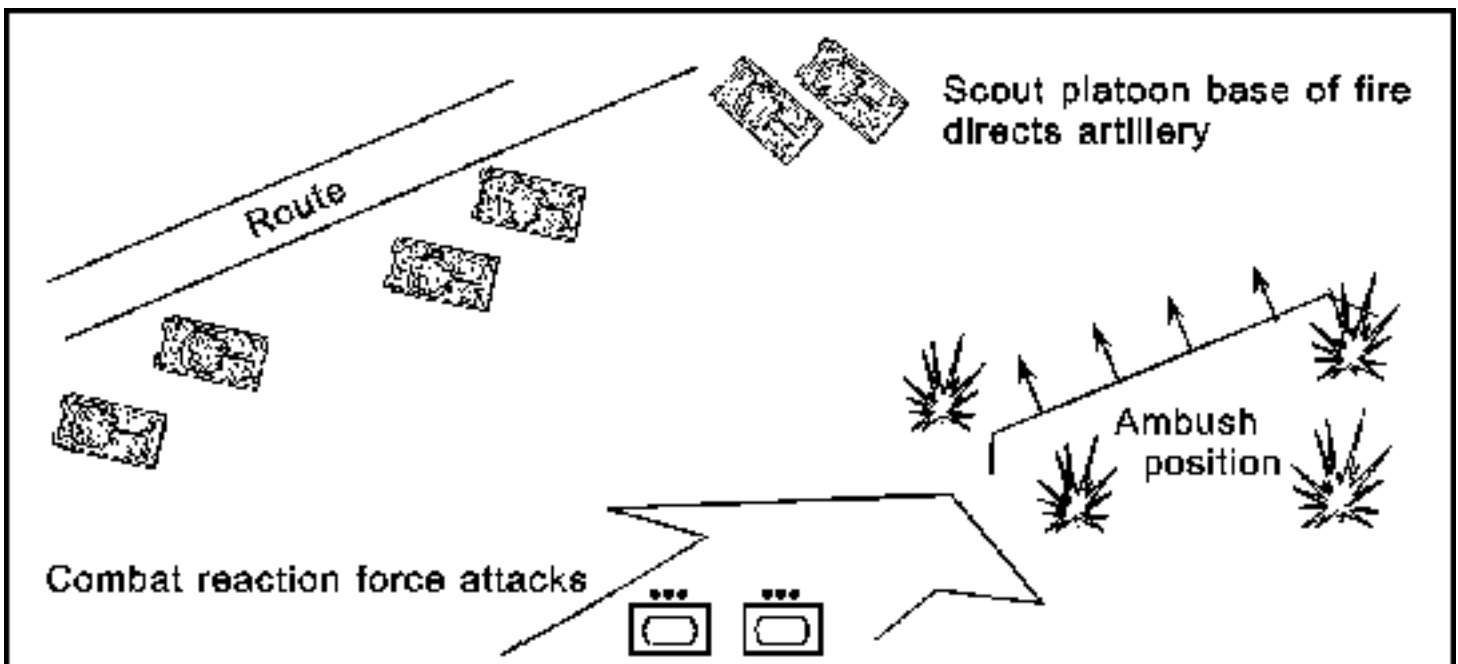

Figure 4-25A. Escort suppressing ambush for reaction force

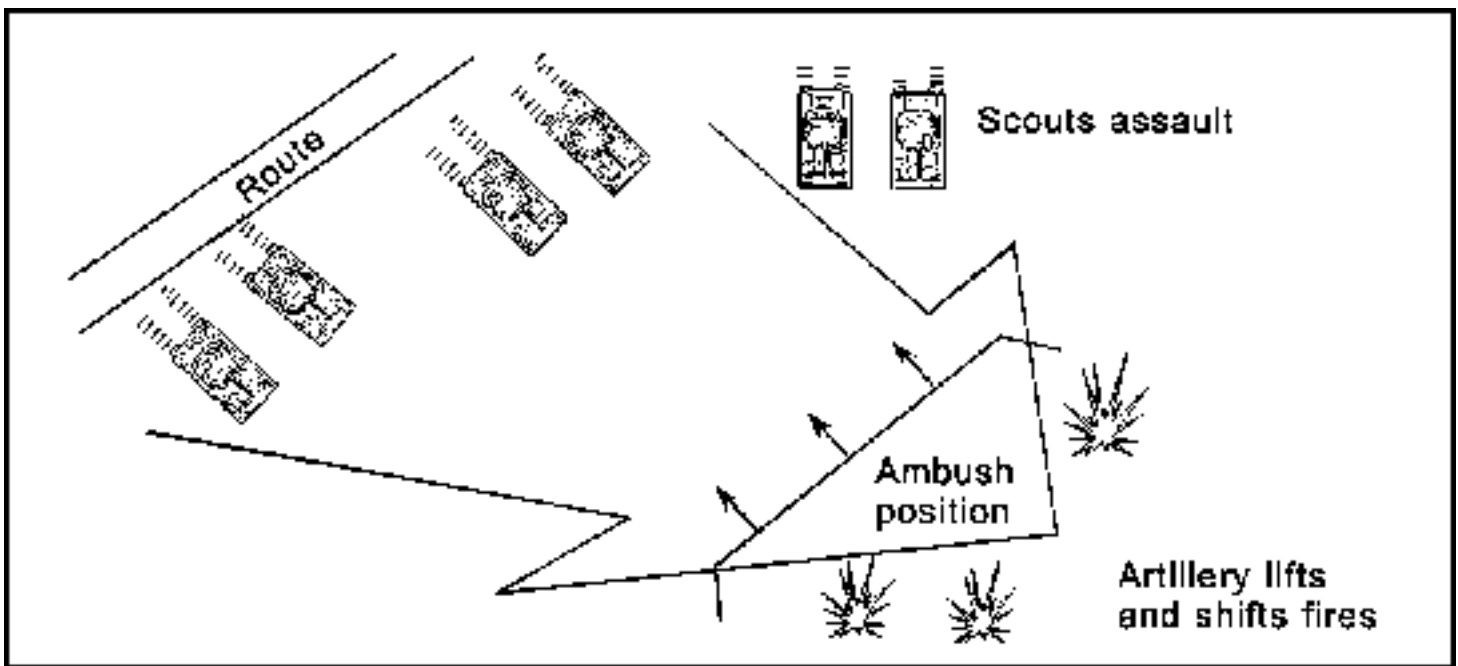

Figure 4-25B. Escort assaulting ambush position.

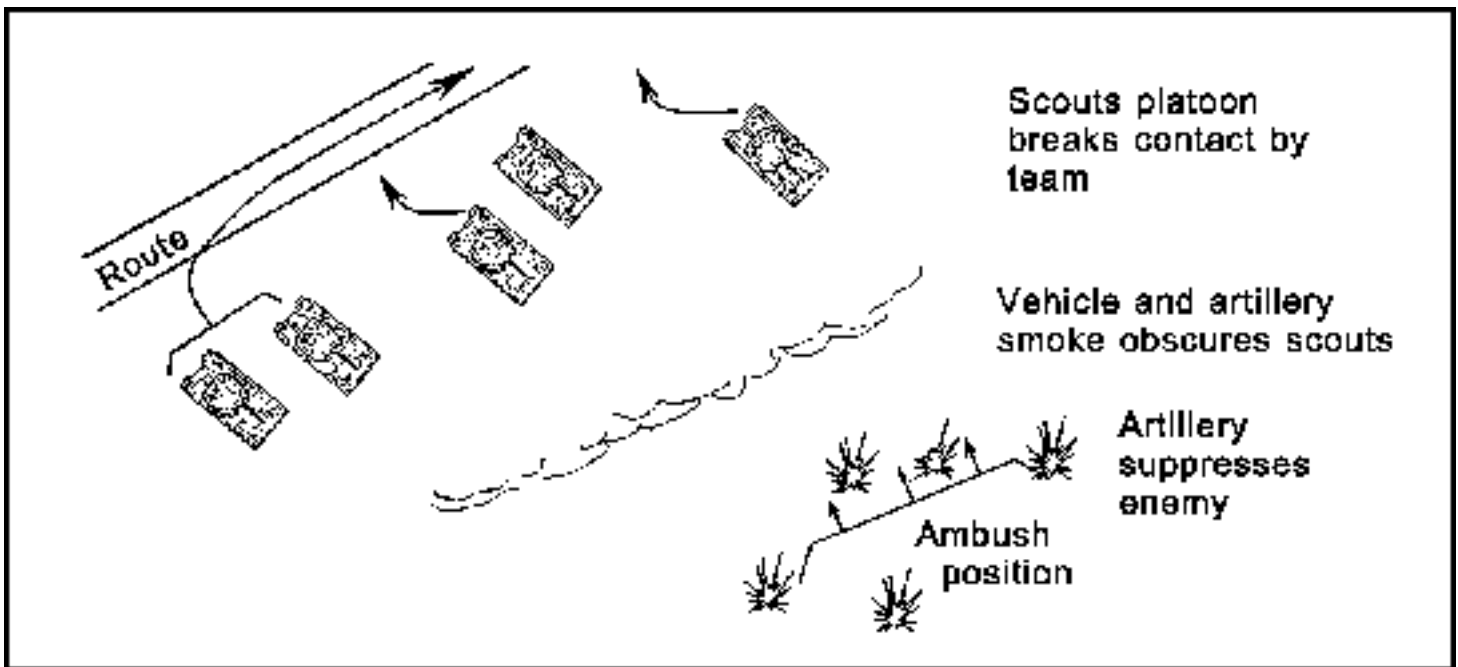

Figure 4-25C. Escort breaking contact.

Generally, CFV-equipped scout platoons will continue to suppress the enemy or execute an assault because of their vehicles' capabilities. HMMWV units are more likely to move out of the kill zone as soon as the convoy is clear. Contact should be broken only with the approval of the scout platoon's higher commander.

Actions during a short halt. The convoy may be required to make a short halt for a number of reasons. During the short halt, the escorting unit is at REDCON-1 regardless of what actions convoy vehicles are taking. If the halt is for any reason other than an obstacle, these actions should be taken:

- The convoy commander signals the short halt and transmits the order via tactical radio.
- The convoy assumes a herringbone formation. Escort vehicles take up protective positions

forward, to the rear, and to the flanks (up to 100 meters beyond the convoy vehicles, as applicable) and orient their weapon systems outward. They remain at REDCON-1, although they establish dismounted local security (see [Figure 4-26A](#)). The vehicles being escorted pull into the protected area in the center of the road, between the escort vehicles. (**NOTE:** Escort vehicles should not leave the roadway if there is a threat of enemy mines.)

- When the order is given to move out, convoy vehicles first reestablish the column formation, leaving space for the escort vehicles (see [Figure 4-26B](#)). Once the convoy is in column, the escort vehicles join the column, leaving local security dismounted (see [Figure 4-26C](#)).
- Once all elements are in column, local security personnel mount, and the convoy continues to move.

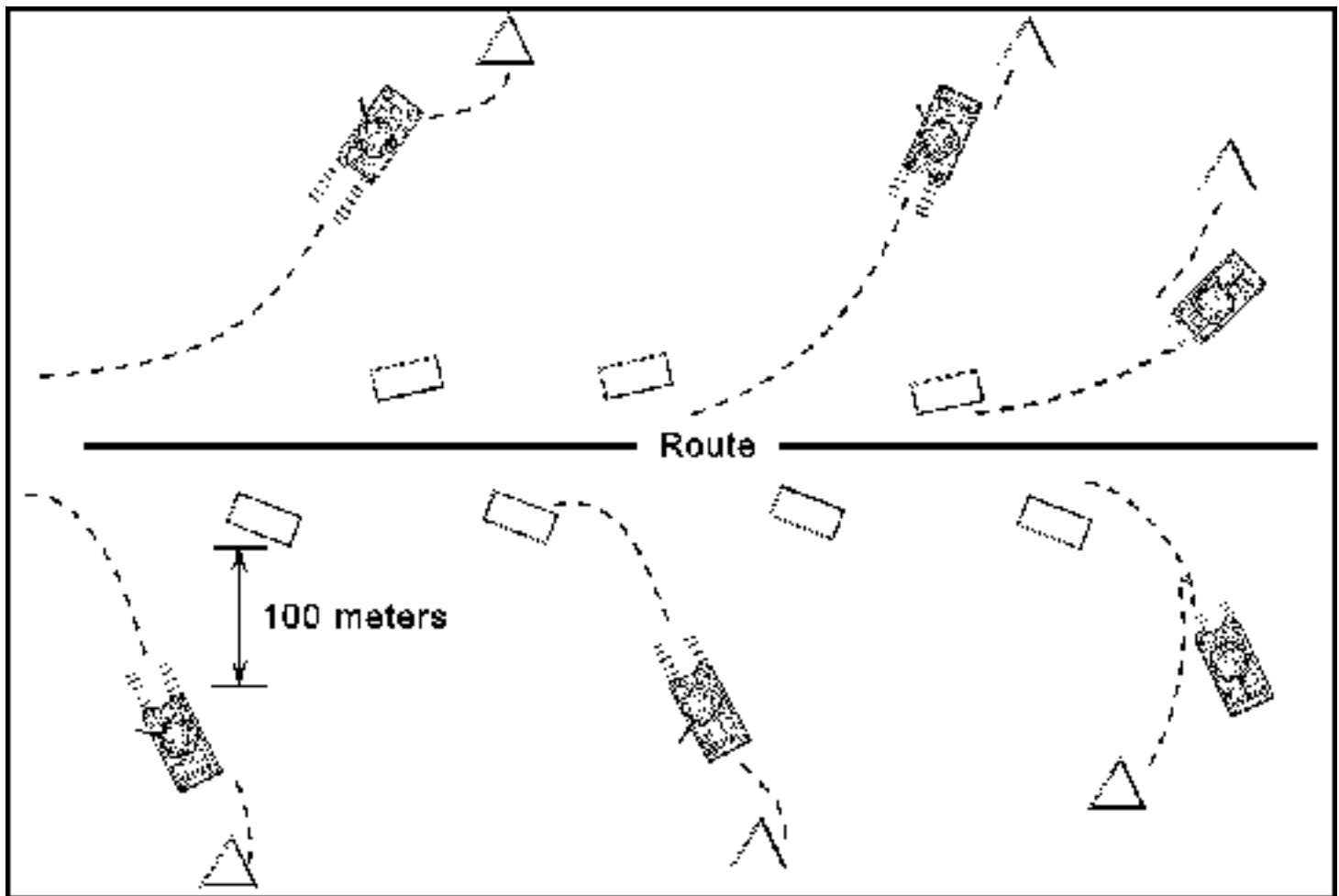

Figure 4-26A. Convoy assuming herringbone formation.

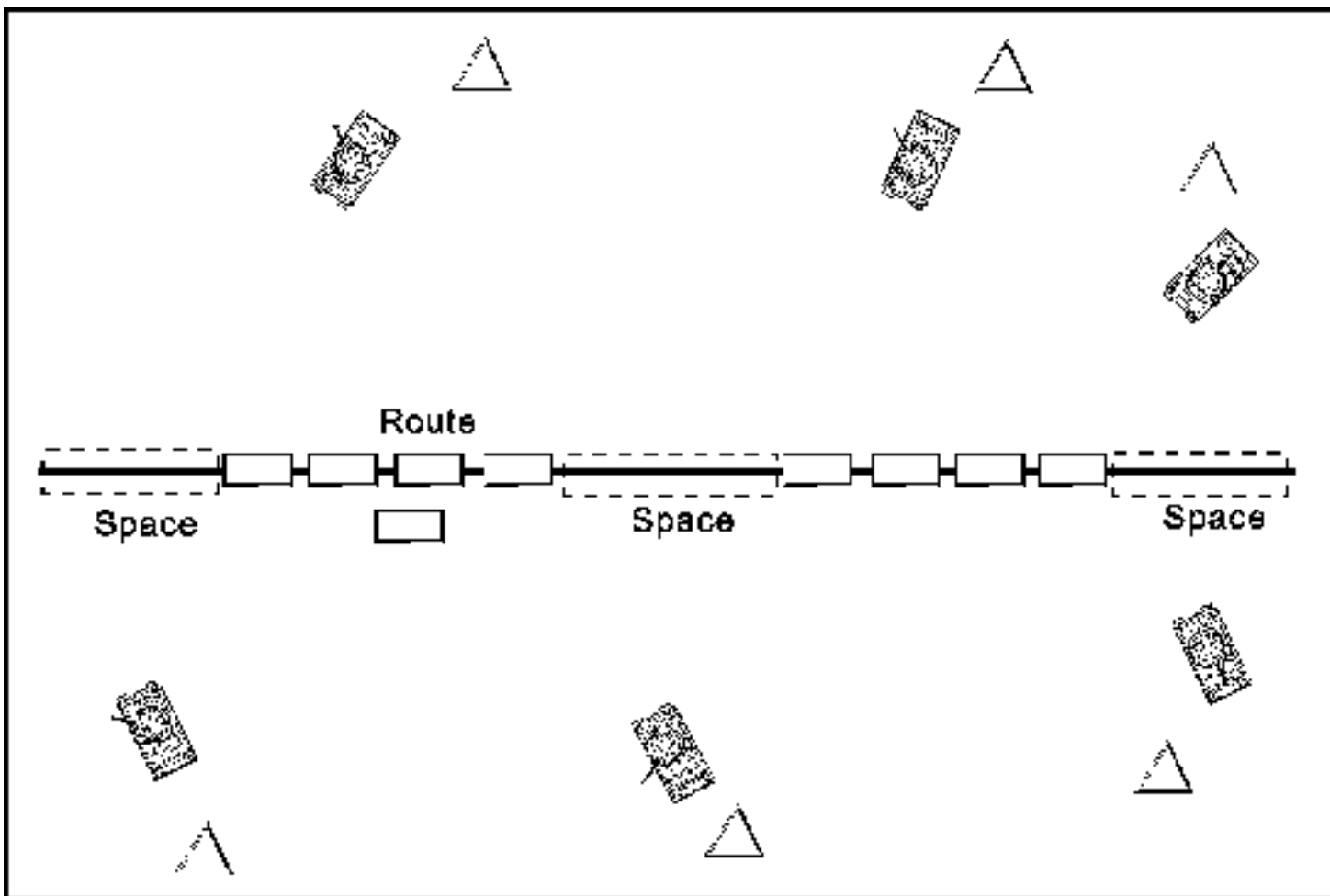

Figure 4-26B. Convoy moving back into column formation.

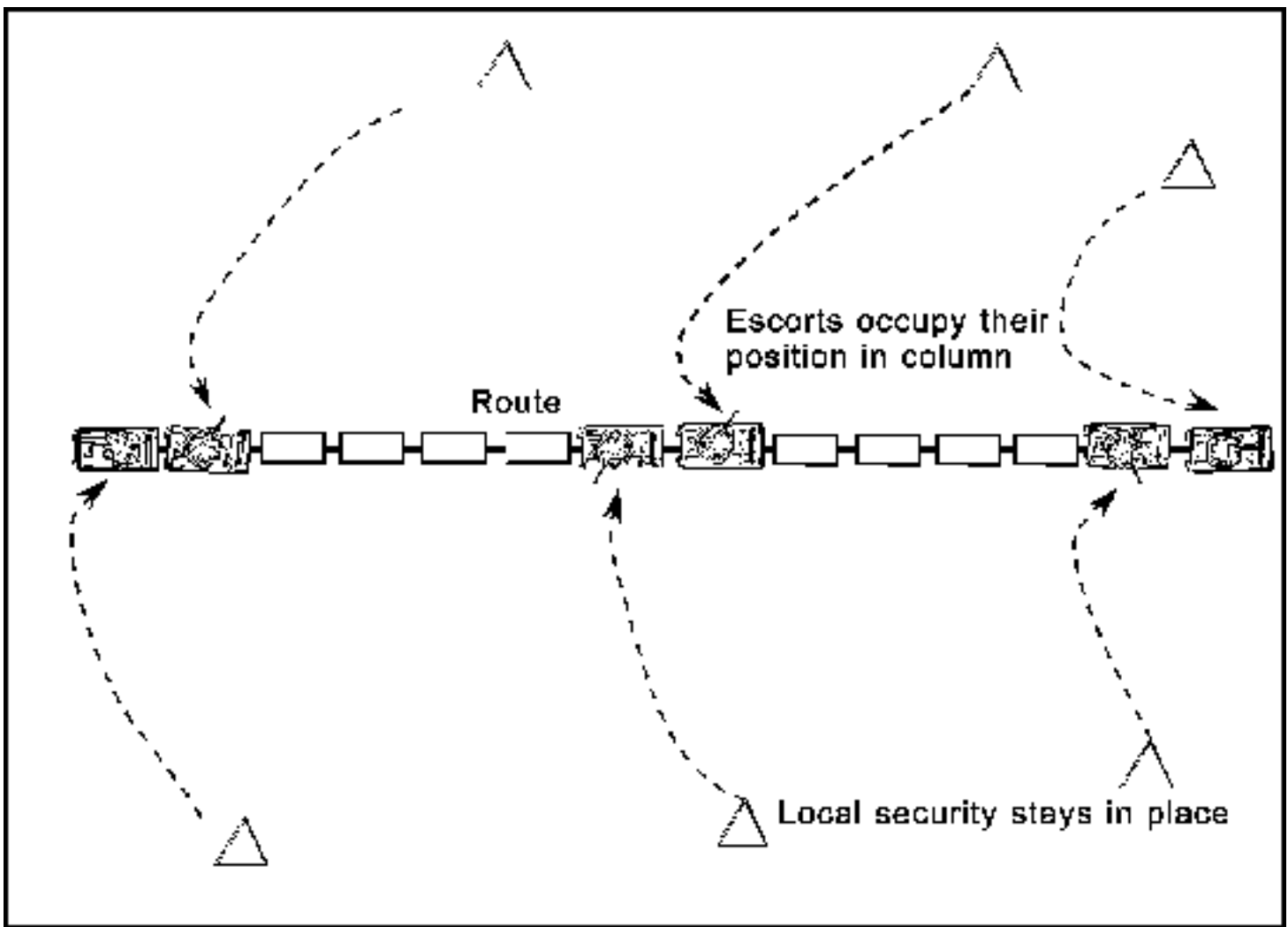

Figure 4-26C. Escort vehicles rejoining column.

Actions at an obstacle. Obstacles are a major threat to convoys. Obstacles can be used to harass the convoy by delaying it; if the terrain is favorable, they may be able to stop the convoy altogether. In addition, an obstacle or series of obstacles can be used to channel or stop the convoy to set up an ambush.

The purpose of the route reconnaissance ahead of the convoy is to identify obstacles and either breach them or find bypasses. In some cases, it is not possible to mount a route reconnaissance ahead of the convoy; in other cases, the reconnaissance element may fail to detect the enemy or its obstacles. In either situation, the convoy must take actions to reduce or bypass the obstacle.

When a convoy is dealing with an obstacle, it faces a two-sided problem: it is more vulnerable because it is stopped, and its escort force is occupied with tasks required to overcome or bypass the obstacle. For these reasons, security becomes critical, and actions at the obstacle must be accomplished very quickly.

The following actions should be taken when the convoy escort encounters a point-type obstacle:

- When the lead security element identifies the obstacle, the convoy commander directs a short halt. He establishes dismounted local security and overwatch of the obstacle. Convoy vehicles remain on the road, with the escort elements moving to the flanks to provide security. (**NOTE:** All convoy vehicles must be aware that the enemy may have buried mines in the area, especially on the flanks of the road.)

- The convoy commander relays a spot report to higher headquarters and requests support by combat reaction forces, engineer assets (if they are not already part of the convoy), and aerial reconnaissance elements. In addition, he alerts artillery units to be prepared to provide fire support. Employment of these assets is designed to reduce the time the convoy is halted and thus to reduce its vulnerability. The convoy commander must always assume that the obstacle is overwatched and covered by the enemy.
- The escort forces form a reconnaissance team and begin reconnaissance for a bypass while maintaining 360-degree security of the convoy (see [Figure 4-27](#)).
- Simultaneously, an additional reconnaissance team made up of escort elements and/or engineers moves forward to conduct an obstacle reconnaissance. Because of limited time and assets, the convoy does not need to establish far-side security prior to reconnaissance of the obstacle (see [Figure 4-27](#)).
- Once all reconnaissance is completed, the convoy commander determines which of the following COAs he will take:
 - Bypass the obstacle.
 - reach the obstacle with the assets on hand.
 - Breach the obstacle with reinforcing assets.
- The convoy commander executes the best COA and continues the mission.

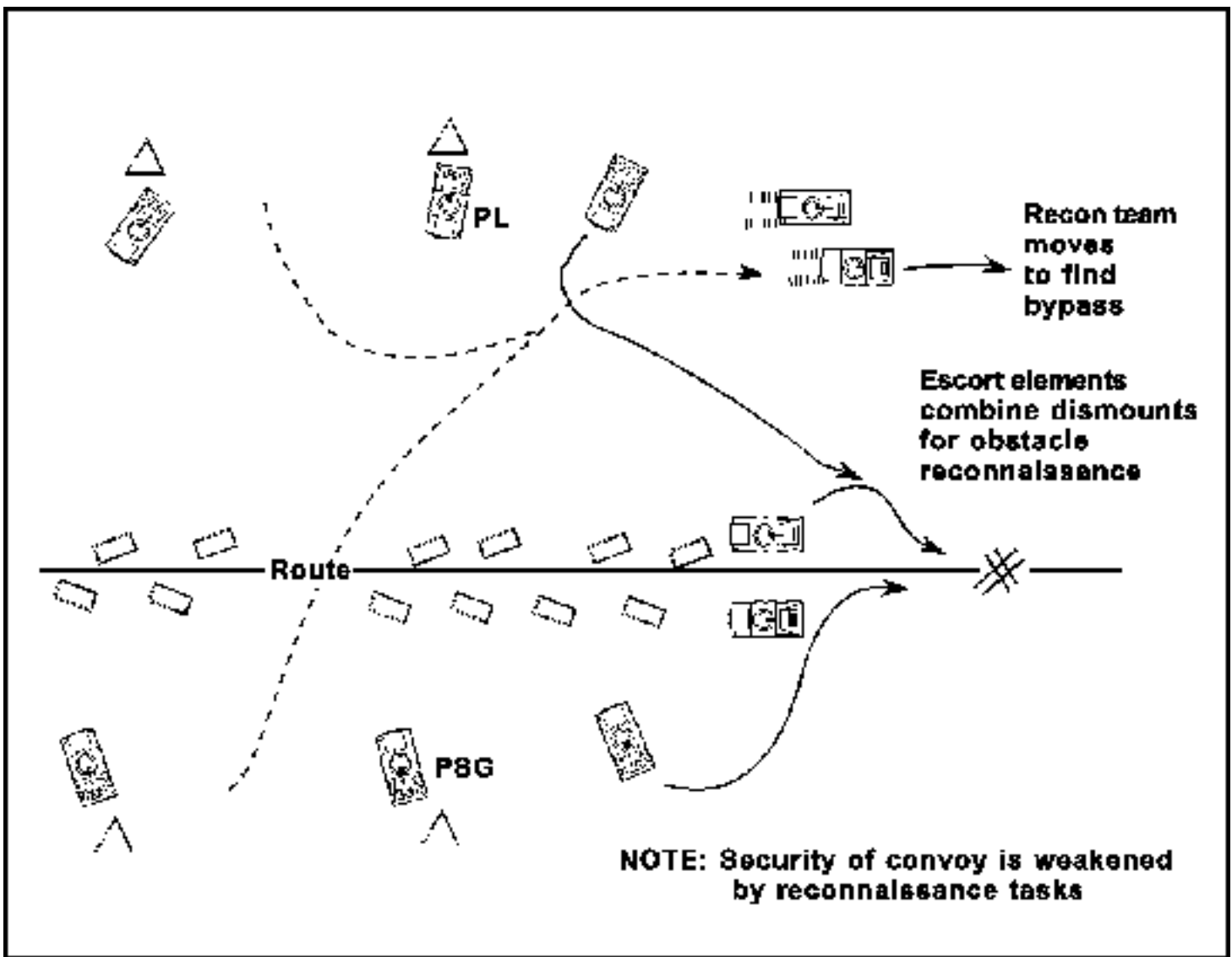

Figure 4-27. Escort teams conducting obstacle reconnaissance and reconnoitering for a bypass.

AREA SECURITY

Scout platoons are normally assigned area security missions to protect high-value targets. The requirement for protection is based on METT-TC. The scout platoon leader must integrate his elements into the overall security plan for the area he is protecting. Area security operations make use of a variety of techniques and may include reconnaissance, security, defensive, and offensive tasks.

When deploying for area security, the platoon generally moves into in a coil formation around the point, area, or asset to be secured. Vehicle positions are adjusted to orient on likely enemy avenues of approach. If engineer support is available, the vehicle positions are dug in; if not, vehicles occupy hasty fighting positions.

To further improve the position, the platoon employs hasty protective minefields and wire and other obstacles as appropriate and available. Wire obstacles should be emplaced outside grenade range of friendly positions. Once vehicle positions and obstacles are established, the platoon develops a fire plan, including integrated indirect fires, and submits it to its higher headquarters.

In addition to setting up the platoon position around the asset to be secured, the platoon also employs patrols and OPs to enhance security (see [Figure 4-28](#)). It employs reconnaissance patrols and combat patrols as needed to become familiar with the area of operations, to gain information on enemy forces, and to destroy small enemy dismounted reconnaissance elements. OPs are deployed to observe likely avenues of approach, to provide early warning of enemy activity, and to assist in controlling indirect fires.

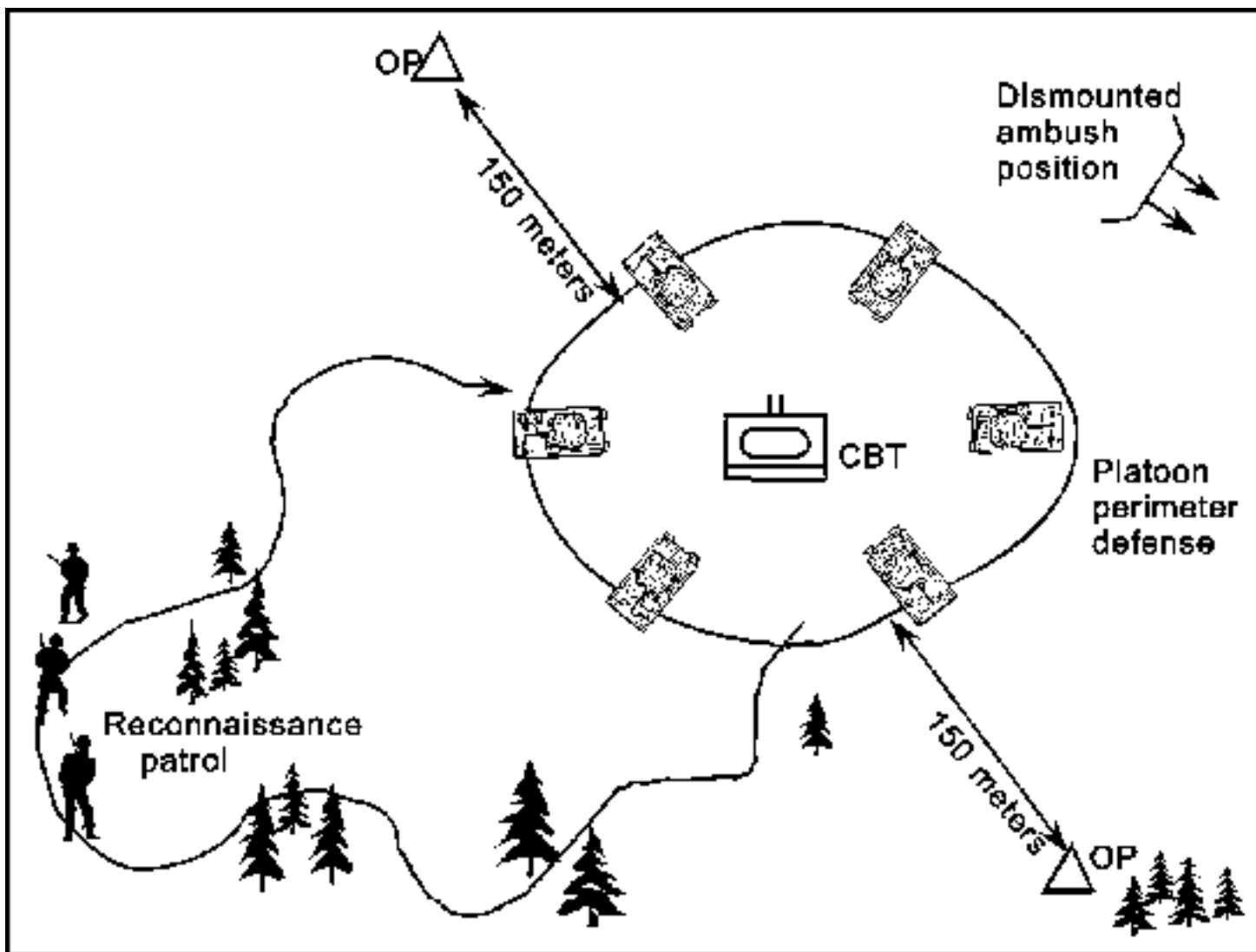

Figure 4-28. Platoon area security dispositions.

CHAPTER 5

Other Tactical Operations

Several combat operations are routinely associated with the successful accomplishment of the reconnaissance and security missions described in [Chapters 3](#) and [4](#) of this manual. These operations entail special planning and training considerations because of their complexity. Scout platoons must execute them based on standardized procedures and must support their parent units' execution of these operations.

CONTENTS

<u>Section 1</u>	<u>Assembly Areas</u>
<u>Section 2</u>	<u>Road Marches</u>
<u>Section 3</u>	<u>Battle Handover and Passage of Lines</u>
<u>Section 4</u>	<u>Relief in Place</u>

SECTION 1 — ASSEMBLY AREAS

An assembly area is a site where a unit regroups or prepares for future operations. Normally, a scout platoon occupies an assembly area as part of its parent unit, but it may occupy one independently. Once in the assembly area, the platoon prepares and issues orders, conducts resupply operations, repairs and maintains vehicles and equipment, and feeds and rests its soldiers.

CHARACTERISTICS

The scout platoon is often directed to find, secure, and occupy an assembly area. There are certain characteristics the scouts must look for when selecting the assembly area:

- Concealment from overhead observation.
- Cover from direct fire.
- Good drainage and a ground surface that will support the platoon's and/or the parent unit's vehicles.
- Adequate entrances, exits, and internal roads.
- Enough space for adequate dispersion of vehicles, personnel, and equipment.
- Adequate defensibility and fields of fire.

QUARTERING PARTY RESPONSIBILITIES

As part of its parent unit or on its own, the scout platoon may have to assume quartering party duties. Understanding these duties makes occupying the assembly area much easier. The quartering party's mission is to reconnoiter the area for enemy presence and booby traps, designate vehicle locations, prepare the area for occupation, and assist units with occupation. The platoon leader or PSG designates the vehicles and personnel from the platoon that will be part of a battalion or troop quartering party. The entire platoon may also serve as the battalion or troop quartering party.

The quartering party moves to the new assembly area under the control of the battalion headquarters and headquarters company (HHC) commander, battalion S1, troop XO, or troop first sergeant (1SG). The following discussion outlines the primary responsibilities of the quartering party.

Reconnoiter the area

The first task of the quartering party is to conduct an area reconnaissance of the assembly area to find enemy forces, obstacles, and NBC contamination. This is a time-consuming process that must be planned for by the parent unit. Once enemy forces are eliminated, the area must be secured to prevent enemy infiltration. To do this, the quartering party establishes OPs or security patrols. If the enemy situation warrants, the officer in charge (OIC) or NCO in charge (NCOIC) may need to enlarge the quartering party to include security personnel who can provide adequate security while other members of the party organize and mark the assembly area.

Determine if the area is suitable

Once the area is secure, the OIC or NCOIC must conduct a reconnaissance to verify the area's suitability and to position guides and markings. This task can be conducted in conjunction with the initial area reconnaissance. When checking the position for suitability, the quartering party analyzes cover and concealment, drainage, routes into and out of the area, internal routes, defensibility, and fields of fire. If the area is unsatisfactory, the scouts should immediately begin looking for an alternate site to recommend to the commander. The OIC or NCOIC should notify the commander immediately, reporting his actions and recommendations and requesting further instructions.

Organize the area

The quartering party designates positions on the ground for the various elements within the assembly area. The siting should be consistent with the commander's guidance, unit SOP, and follow-on missions. The frontages selected for the various elements must be consistent with terrain considerations and must allow adequate defensive coverage.

Improve and mark entrances, exits, and internal routes

Once the organization of the assembly area is complete, the quartering party marks the positions. It also reconnoiters and marks routes from the RP to the assembly area. The actual entrance and exit for the assembly area must be well marked to facilitate easy movement. The quartering party designates and marks internal routes to prevent excessive movement that could create a large unit signature. Unit SOP should dictate the marking system to be used. Examples of markings include chem lights, engineer tape, unit tactical signs, flashlights, VS-17 panels, and thermal tape.

Mark or remove obstacles and mines

Ideally, the commander should have some indication of current or past presence of an enemy in the proposed area. If there is a possibility of mines or CBU's in the assembly area, additional scouts or combat engineers with mine-detecting equipment should be requested before the quartering party departs. Obstacle and mine clearance requires prior planning to ensure sufficient quantities of the proper equipment are available. This equipment may include pioneer tools, demolitions, or engineer vehicles. Sufficient time must also be allocated to allow the quartering party to accomplish this mission before the main body arrives. If the first area selected contains numerous obstacles, an alternate area should be reconnoitered.

Perform guide duties

The quartering party prepares the assembly area to make the occupation of the new positions swift and efficient. This can be a wasted effort if the guides do not perform their duties properly. Because the quartering party is familiar with the area and the vehicle positions, the vehicle commanders rely, at least initially, on the guides to position the platoon; therefore, guides must be thoroughly briefed prior to the mission.

The guides are positioned between the RP and the assembly area entrance so that they can meet their unit as it crosses the RP. They must know the proper route from the RP to the new positions; they quickly move their units through the RP and into the assembly area. They do not stop until vehicle positions are occupied. Once in the new area, the guides direct the vehicles to their tentative positions. Immediately afterward, they walk the platoon leader through the positions, briefing him on the individual vehicle positions, adjacent units, fields of fire, location of the CP, and any other essential information.

Accomplish additional assigned tasks

If the commander assigns any additional tasks, the quartering party must accomplish them. The commander should prioritize these tasks; if he does not, the quartering party leader must arrange a priority of tasks that allows for the most important to be accomplished first. Examples of such additional tasks include establishing priorities of work, providing security for the command group, test-firing weapons, and assisting in traffic control.

OCCUPATION

When a unit arrives at an assembly area, all elements move off the route of march and clear it without slowing or halting. The platoon leader should keep this in mind as he posts guides, selects routes, and allocates space in the assembly area. After a march serial has cleared the route, it can adjust vehicle positions without holding up traffic.

ACTIONS IN THE ASSEMBLY AREA

As soon as the platoon occupies its area, it must automatically execute the priority of tasks outlined in [FKSM 17-98-3](#). Initial tasks include these:

- Position vehicles.
- Establish local security.

- Establish lateral contact with vehicles on the flanks.
- Develop range cards or sector sketches and submit them to the platoon leader for inclusion in the platoon fire plan. Scouts may have to adjust their positions accordingly.
- Camouflage positions.
- Perform preventive maintenance checks and services (PMCS).

Security is a constant concern in assembly areas. Noise and light discipline are especially important, as is limiting the number of vehicles that enter and exit the assembly area. The local security that is initially established will be replaced by more permanent OPs once the platoon is established in position; these OPs are deployed in accordance with procedures outlined in [Chapter 8](#) of this manual. The platoon leader or higher commander may also require patrols (mounted and dismounted) within the assembly area, especially in limited visibility. Wire and messengers are the primary means of communications. How many wire lines are laid depends on how long the platoon will be in the assembly area. Radio is used only in emergencies when no other means of communications is available.

DEPARTING THE ASSEMBLY AREA

Departing an assembly area is a critical and often overlooked task. A well-organized departure sets up the platoon for its next mission. A poorly organized departure can cause delays and other problems that may adversely affect the platoon's mission before it begins.

The departure requires thorough planning and preparation, including a walk-through rehearsal. As part of the preparation, a thorough police call must be conducted. This ensures that all evidence of the unit's occupation is removed and denies the enemy any equipment, supplies, or other items that might be of tactical or intelligence value. Leaders must carefully supervise execution of the departure to ensure that no delays occur.

SECTION 2 — ROAD MARCHES

Units not engaged in combat may have to travel long distances to position themselves for future operations. These movements are planned at battalion, squadron, and company/troop level, but they are executed by the subordinate units involved, including the scout platoon. Success depends largely on unit discipline and the platoon's ability to execute the plan with strict adherence to SOP.

The road march differs from other forms of movement in these ways:

- The purpose is relocation, not making contact.
- The primary consideration is rapid movement of vehicles.
- It is conducted at a prescribed speed.
- A prescribed interval is maintained between vehicles.

As part of a battalion task force, a scout platoon may perform various duties during a road march: manning traffic control points (TCP), serving as road guides or as a quartering party, or conducting route reconnaissance.

PREPARING FOR ROAD MARCHES

The basic considerations in planning any road march are METT-TC factors (especially the enemy situation and the mission), the march order, and the type, number, and characteristics of vehicles available for the movement. When preparing for a tactical road march, the scout platoon should use the following planning sequence if time permits:

- Prepare and issue the warning order as early as possible to allow maximum time for preparation.
- Prepare an estimate of the situation, specifying organization of the march column.
- Organize and dispatch reconnaissance and quartering parties.
- Prepare detailed movement plans based on the organization of the march column and a review of available reconnaissance information.
- Prepare and issue the march order.
- Prepare overlays and issue them to all vehicle commanders and subordinate leaders. The road march overlay should include, as a minimum, the location of the SP, RP, scheduled halts, and checkpoints at critical points along the route.

MARCH COLUMNS

A tactical march may be conducted in close column or open column or by infiltration. In dusty conditions, vehicles must be spaced so that the dust from one does not blind the driver of the next.

Close column

Close column is normally used for marches during limited visibility conditions. Under these conditions, vehicles are spaced so the driver can see the two lights in the blackout marker of the vehicle ahead, about 25 to 50 meters apart. Close column marching takes advantage of the traffic capacity of the route, but it provides little dispersion. Traffic density is approximately 20 to 40 vehicles per kilometer along the route of march.

Open column

Open column is generally used during daylight. The distance between vehicles is increased to provide greater dispersion; it varies from 50 meters to 100 meters, or more if the situation requires. Open column may also be used at night with infrared lights, blackout lights, or passive night-vision equipment. Normal vehicle density is approximately 20 vehicles per kilometer when vehicles are 50 meters apart, 12 vehicles per kilometer when the distance is 75 meters, and 10 vehicles per kilometer when the distance is increased to 100 meters. The increased dispersion of the vehicles in open column movement enhances security.

Infiltration

Infiltration provides the best possible passive defense against enemy observation and attack, but it may be difficult to control. It is suited to tactical marches when sufficient time and road space are available and maximum security, deception, and dispersion are desired. The advance party usually infiltrates. Vehicles are dispatched individually, in small groups, or at irregular intervals at a rate that reduces traffic density and prevents undue massing of vehicles. (**NOTE:** Refer to the discussion of infiltration in

[Chapter 3](#) of this manual.)

MARCH COLUMN CONTROL

Column control is maintained through the chain of command. Each scout vehicle has a prescribed place in the platoon march column as described in [FKSM 17-98-3](#).

Start point

An SP provides all vehicles of a march column with a common point for starting their movement. When vehicles use more than one route, each route has an SP. The SP is a recognizable place along the route of march, such as a road intersection. It should not be in a defile, on a hill, or at a sharp curve in the road that could cause movement to slow. It should be far enough from assembly areas to allow vehicles to be organized and moving at the prescribed speed when they reach it. Before starting a march, elements of the platoon should reconnoiter the route to the SP to determine times for major units of the serial to arrive at and clear the serial SP.

Release point

An RP gives all vehicles of the march column a common point for reverting to control of the platoon leader. It is a point on the route of march that is easy to recognize on the map and on the ground. Guides should meet vehicles as they arrive at the RP and lead them to their new positions, usually in an assembly area. Multiple routes and cross-country movement from the RP to assembly areas allow vehicles to disperse rapidly. In selecting an RP, leaders should avoid hills, defiles, and sharp curves that may cause elements to slow or stop on the route. No vehicle should be required to countermarch or pass through another element to reach its new position.

Checkpoints

Checkpoints on a route are used for reference in providing instructions and in identifying places where interference with movement might occur or where timing might be critical.

Restrictions

Restrictions are points along the route of march where movement may be limited or obstructed during certain time periods; examples include bridges, intersections, ferries, or bypasses. The march planner should start the move early enough to pass such a point before a restriction begins, delay the start of the move to pass a restriction after it has ended, or plan to halt the column along the route until the restriction is lifted.

Traffic control

The parent unit controlling the march normally provides traffic control. TCPs manned by military police and/or other personnel, including members of the scout platoon, may be located at critical points along the route. Among the factors that can increase traffic control problems are movement on multiple routes during periods of limited visibility and the existence of major intersections, defiles, and detours along routes. In a battalion task force, the scout platoon may act as road guides to assist the military police. Road guides may lead serials or march units on a particular route or portion of a route or through a critical area. These guides must follow the same procedures and guidance as other TCP personnel.

TCP personnel should be employed in pairs, with one directing traffic while the other provides security. They need to know the exact number of vehicles in each march serial, the markings for each serial, and the passing times so that they can adequately control and report the movement of the unit. Considerations for manning the TCP include weather, the marking system for the TCP and route (to include critical turns), limited visibility procedures, and recovery of the TCPs. The scout platoon leader or PSG has several options in deciding how to man the TCP, to include manning with individual vehicles (up to six TCPs), dropping off platoon personnel with FM communications at each TCP, or requesting augmentation if needed.

Speed control

Vehicles in a column of any length may simultaneously encounter many different types of routes and obstacles. This causes different parts of the column to move at different speeds at the same time, producing an undesirable accordion or whip effect. The movement order specifies march speed, rate of march, and maximum safe catch-up speed to reduce "column whipping." The lead vehicle must not exceed the authorized maximum speed of the slowest vehicle in the column. To minimize vehicle congestion on the near side of an obstacle, vehicle commanders and drivers must be alert and maintain the prescribed minimum following distance. Vehicles should make only gradual speed changes while maintaining their prescribed interval. Vehicle commanders must constantly be aware of the vehicle interval to their front and rear and adjust their speed accordingly.

Halts

Halts are conducted to allow following traffic to pass and to provide time for rest, personal comfort and relief, mess activities, refueling, maintenance and inspection of equipment, and adjustments in schedule. The time and duration of halts are usually specified in the movement order or prescribed in unit SOP. The SOP should also prescribe actions to be taken during halts. Vehicle crews perform maintenance at scheduled halts.

A short rest halt of 15 minutes is usually taken after the first hour of marching. A 10-minute short halt is taken every two hours thereafter. The prescribed rate of march includes the time required for short halts. When possible, march elements using the same route stop at the same time. Route characteristics, however, may make it necessary to halt at a particular point on the route rather than simultaneously at a fixed time.

Long halts are planned in advance. The length of the halt is added to the total travel time. Locations for long halts are normally selected to allow all vehicles to clear the road and to permit proper dispersion. Halts for refueling should be scheduled in advance by the unit commander.

The herringbone formation is used to provide security for the march column during unscheduled halts (see [Figure 8-16](#)). All vehicles should move completely off the road to permit passage of vehicles down the center of the column. Movement commanders give permission for execution of unscheduled halts.

The first priority at any halt is local security. OPs are established and sectors of fire assigned to each vehicle. These actions should be automatic and part of the unit SOP (see [Chapter 4](#) of this manual for a discussion of area security operations).

Miscellaneous factors

Disabled vehicles. Disabled vehicles must not obstruct traffic. Their crews must move them off the road and report their status immediately to the PSG. Crews must immediately signal the follow-on vehicles to bypass and continue movement. They then establish security and post guides to direct traffic. If possible, the crews repair their vehicles and rejoin the rear of the column just ahead of the trail element. Vehicles that have dropped from the column should return to their positions only when the column has halted. The trail party recovers vehicles that cannot be repaired by their crews.

Start of movement. Vehicle commanders must remain alert and exercise caution whenever they start to move. Vehicles that move too soon or too late can cause confusion in the formation. Lead vehicles must keep speeds low until all vehicles have moved onto the route of march.

Observation. Each vehicle commander assigns sectors of observation to his crewmen to provide 360-degree observation. He also designates one observer as the air guard to provide air security. Each vehicle has a sector of observation as shown in [Figure 5-1](#).

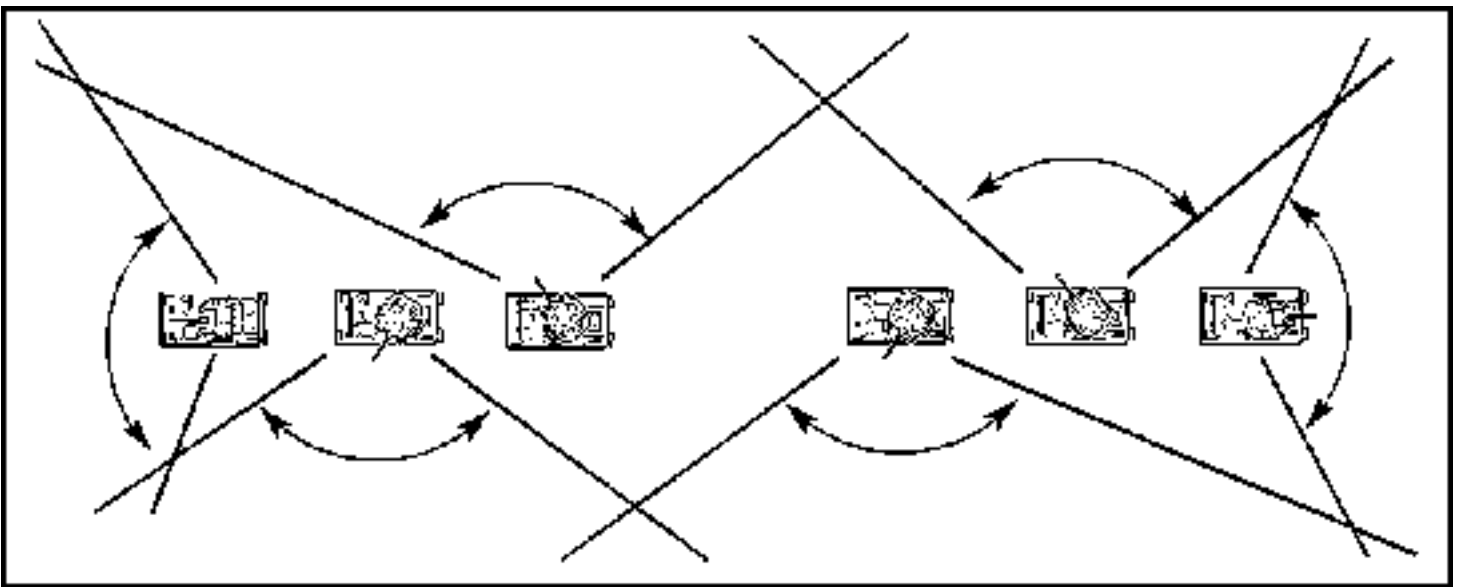

Figure 5-1. Sectors of observation in a road march.

ROAD MARCH TRAINING

Overall success or failure of a mission could depend on the ability of units to march rapidly and efficiently over long distances. The unit's level of road march training is thus a major factor in determining mission success. Important factors in training for tactical road marches include the following:

- **Driver training.** The vehicle driver can make or break a road march. He must know the proper march interval and following distances; he must understand the effect the speed of his vehicle can have on the rest of the serial. Drivers can use man-made features (such as utility poles) or time/distance factors to gauge distance between vehicles. For example, at 15 miles per hour (mph) with a 100-meter interval, there are 15 seconds between vehicles; 20 mph and a 100-meter interval equals 11 seconds between vehicles.
- **NBC.** All members of the organization must be trained in NBC countermeasures and driving in NBC gear.

- **Air guards.** As noted, each vehicle commander designates an air guard who is responsible for detecting enemy aerial platforms. Refer to [Chapter 6](#) of this manual for a further discussion of active and passive air defense measures.
- **Actions on contact.** The platoon must be ready to execute immediate action drills in accordance with unit SOP at any time during the road march. Refer to [Chapter 8](#) of this manual for a detailed discussion of actions on contact.
- **Constant practice.** Road march training must be conducted at every opportunity; road march techniques can be practiced even in routine situations, such as two vehicles moving together outside a motor pool.
- **Systematic training.** The unit should first master road march techniques under good conditions (in the daytime, over short distances, and with good communications). It then must work toward mastering these skills under difficult conditions, including operations involving limited visibility, blackout, long distances, and radio listening silence.

SECTION 3 — BATTLE HANDOVER AND PASSAGE OF LINES

Battle handover is an operation conducted by stationary and passing units in a close-in battle to transfer responsibility for fighting an enemy force from one unit to another. It is designed to sustain continuity of the combined arms fight and to prevent the enemy from moving unopposed on the battlefield as one force picks up the fight from another. It is also designed to preserve the fighting capabilities of both friendly units.

A passage of lines is a tactical event associated with battle handover. It is the controlled movement of one unit through the positions of a stationary unit, conducted so that neither unit interferes with the other's scheme of maneuver. A passage of lines often becomes necessary because the combat situation does not permit one unit to bypass another unit's position.

A unit may conduct either a rearward or forward passage of lines. When a unit moves toward the enemy through a stationary unit, it is considered a forward passage. In a rearward passage, the unit moves away from the enemy through friendly units.

A passage of lines may be conducted for the following purposes:

- Continue an attack or counterattack.
- Envelop an enemy force.
- Pursue a fleeing enemy.
- Withdraw security forces or MBA forces.
- Facilitate route, zone, or area reconnaissance.
- Execute a defense or a delay.
- Execute a screen or guard operation.

The scout platoon may perform some of these operations independently (screen and reconnaissance); otherwise, it usually will take part in a passage of lines as part of a larger force.

CRITICAL TASKS

There are three key elements in battle handover and passage of lines: the stationary unit, the passing unit, and the common commander.

The commander exercising command authority over both the stationary unit and the passing unit must designate the battle handover line (BHL); this is a phase line forward of the stationary unit that is recognizable on the ground. He normally does this in coordination with the stationary unit commander, who will recommend the position of the BHL. The line is drawn where elements of the passing unit can be effectively protected by direct fires of the forward combat elements of the stationary unit until the passage of lines is complete. The area between the BHL and the stationary force belongs to the stationary unit commander. The common commander will provide the graphic control measures that depict the BHL and contact points on an overlay issued to subordinate units with the OPORD or FRAGO (refer to [Figure 5-2](#)).

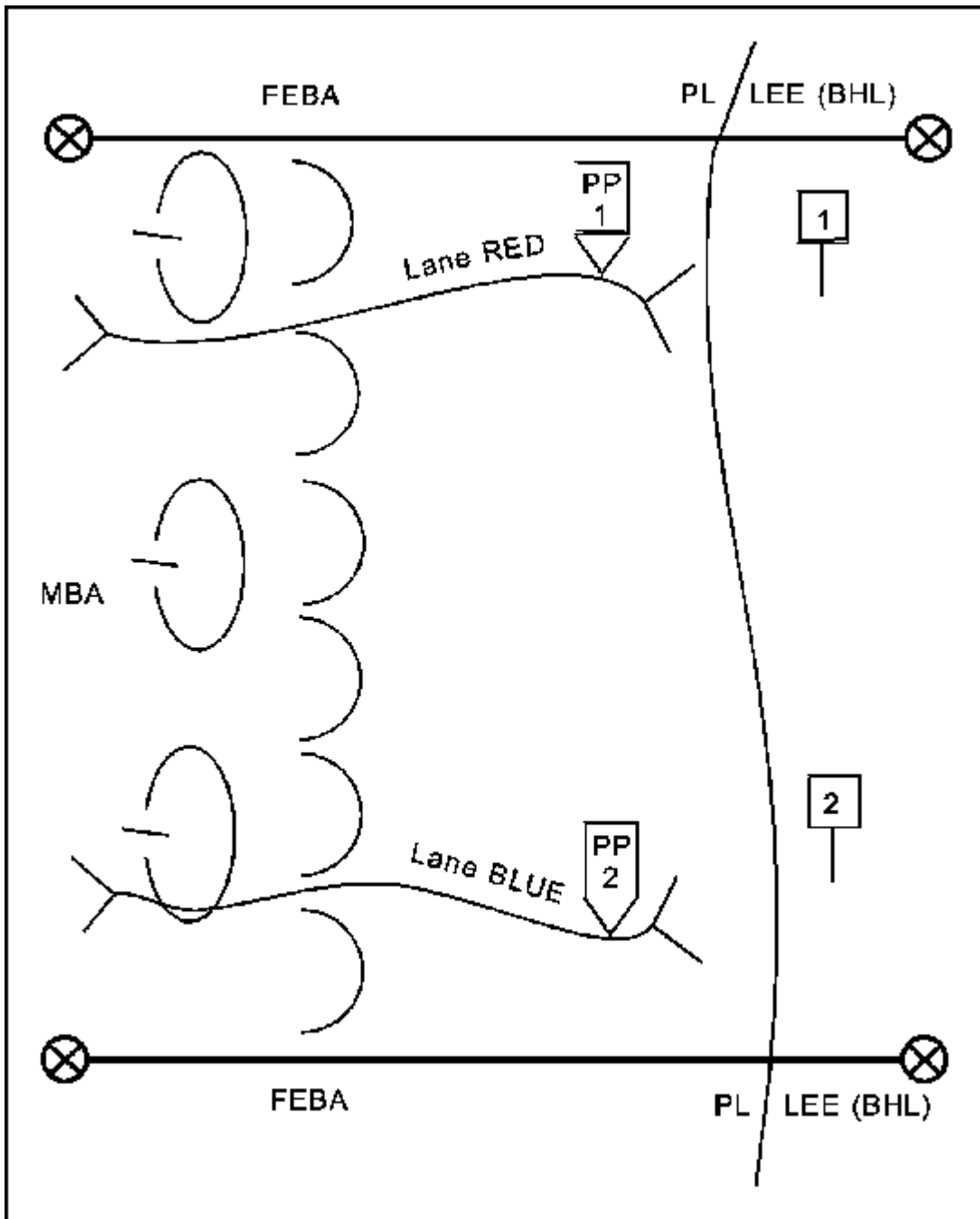

FM 17-98 Appendix G Fratricide Prevention

Battle handover begins on order of the common commander. Defensive handover is complete when the passing unit is clear and the stationary unit is ready to engage the enemy. Offensive handover is complete when the passing unit has deployed and crossed the BHL. The common commander prescribes the specific criteria that mark completion of handover; he ensures that both subordinate commanders understand these criteria.

The scout platoon, acting independently or as part of a troop or battalion passage, may be either the stationary or the passing unit. The platoon will normally assist in some portion of the passage of lines and may be required to coordinate the passage. In many cases, the scout platoon will be required to conduct a passage separate from its higher headquarters.

Passing unit critical tasks

The passing unit must accomplish several critical tasks during battle handover and passage of lines, including the following:

- Immediately establish communications, entering the command, OI, and fire support nets of the stationary unit.
- Collocate a section or vehicle (usually the platoon leader's or PSG's vehicle) with the tactical command post (TAC CP) or main CP of the stationary unit as soon as possible to enhance communications and unity of effort.
- In a rearward passage, continuously report to the stationary unit the location, size, and composition of all enemy forces, as well as the enemy's current activity. If the enemy is attacking, the passing unit reports his direction of movement, movement formation, and estimated rate of advance. If the enemy is defending, passing unit reports include enemy locations, orientation, composition, fire sacks, reserves (if known), obstacle systems, and flanks.
- Continuously report to the stationary unit the location, size, and activity of all parent unit elements, to include CS, CSS, and command and control assets.
- Based on the current dispositions of the parent unit and scout sections, coordinate with the stationary unit to determine contact points at which subordinate elements (such as scout sections) will physically coordinate handover and passage of lines with representatives of the stationary unit. Once contact points are determined, the passing unit leader sends a FRAGO to all sections specifying where they will physically coordinate the passage with the stationary unit. In addition,

the passing unit confirms recognition signals that must be displayed during passage.

- Ensure that each section acknowledges where it must physically coordinate the passage and dispatches representatives to the assigned contact points to coordinate passage for the section. At the contact points, the representatives confirm recognition signals and exchange required information with their counterparts from the stationary unit.
- In a rearward passage, maintain visual contact with all enemy units and conduct a delay back to the BHL, avoiding decisive engagement.
- During the passage, display correct recognition signals and use correct challenge and password as specified in the SOI.
- Maintain proper weapons orientation.

Stationary unit critical tasks

The stationary unit must accomplish a variety of critical tasks when ordered to conduct battle handover and passage of lines. These tasks include the following:

- Establish communications with the passing unit, coordinate necessary contact points, and direct the passing unit to the contact points based on current dispositions of the designated units.
- Ensure that contact points are manned and that passing elements have established personal communications with their representatives.
- Ensure that representatives at the contact points assign each passing element a passage point into the area of operations and a route that extends from the passage points to the rear boundary or assembly area (in a rearward passage) or to the attack position (in a forward passage).
- Ensure that representatives at the contact points exchange required information with the passing unit as outlined in [FKSM 17-98-3](#).
- If security forces are working with the platoon, position them along the BHL where they have the best possible observation of enemy avenues of approach, adjusting as necessary for limited visibility conditions.
- If obstacles are emplaced between the FEBA and the BHL, ensure that routes through the obstacle system are clearly marked and physically controlled by guides or that escorts are provided to the passing unit.
- Ensure that all routes of withdrawal obligated to the passing unit are unobstructed and facilitate rapid movement to the RP.
- Ensure that obligated routes of advance, attack positions, and routes to the BHL are clear and facilitate rapid movement.

PREPARATION

Units are particularly vulnerable during a passage of lines. Personnel and subordinate elements may be concentrated, stationary unit fires may be masked temporarily, and the passing unit may not be disposed properly to react to enemy action. Effective preparation, including detailed reconnaissance and coordination, is critical in overcoming such conditions and ensuring that the passage proceeds quickly and smoothly. The commander may also task the scout platoon with a number of other missions to assist him in preparing for the passage.

Coordination

Coordination occurs at a preplanned contact point where critical information is exchanged and coordinated. Coordination for battle handover normally flows from the commander out of contact to the commander in contact. Coordination for the handover and for the passage of lines should be conducted simultaneously.

The scout platoon leader plays a major role in coordination for handover and passage of lines. He is responsible for conducting reconnaissance to obtain information for use by both his parent unit and the platoon. He then uses this information in the coordination process.

During his reconnaissance, the platoon leader must confirm the following battlefield factors and information:

- The disposition of the stationary force through which his platoon, troop, or battalion must pass.
- The location of contact points where both units are required to make physical contact at a predetermined time.
- The location of passage lanes that provide a clear route through the stationary unit's position to facilitate a smooth and continuous passage. The areas selected for the passage should be unoccupied or on the flanks of units in position. If possible, the platoon leader should reconnoiter multiple routes that can reduce vulnerability during the operation.
- The rear boundary or assembly area (in a rearward passage) or the attack position (in a forward passage). This position should provide cover and concealment and be located where the passing unit will not interfere with the stationary unit.
- The initial locations for CS and CSS elements of the platoon's parent unit.

Based on his reconnaissance, the platoon leader coordinates the following information:

- Contact points (primary and alternate).
- Passage points.
- Passage lanes, including the SP, RP, and critical points.
- The LD.
- Location and number of guides and guide vehicles.
- Routes through obstacles.
- Alternate routes.
- CSS plans, including Class III and Class V resupply, maintenance, medical evacuation (MEDEVAC) and/or casualty evacuation (CASEVAC), and disposition of enemy prisoners of war (EPW).
- Traffic control factors, such as number of vehicles by type.
- Time of the passage.
- Rally points, the rear boundary or assembly area (rearward passage), and/or the attack position (forward passage).
- Actions on contact if required during the passage.
- Time of transfer of responsibility for control of the sector and of handover of the enemy and BHL.

- Exchange of enemy and friendly information.
- Fire support during the passage.
- Direct and indirect fire plans and obstacle plans.

NOTE: The parent unit commander provides some of this information as part of his order to the platoon.

Assistance to the commander

Given the capabilities of the scout platoon, many commanders require the platoon to assist other units in the passage of lines. Primarily, the scout platoon enhances the command and control function for the commander. The platoon may be required to conduct one or all of the critical tasks of a stationary or passing unit or may assist its parent unit in the following ways:

- Elements of the scout platoon may assist in securing contact and passage points where units will meet and pass.
- The scout platoon may reconnoiter possible passage lanes (primary and alternate), clearing them of obstacles (within capability) and marking their locations.
- The scout platoon may guide units from contact points to or through passage lanes. The platoon may also control traffic at the passage point and in the lane.
- Scout platoon elements may be positioned in the passage area to act as a communications link in case units involved in the passage have trouble communicating with each other.
- The scout platoon may conduct area reconnaissance of attack positions (forward passage) and assembly area locations (rearward passage). This reconnaissance effort may include a requirement to check for NBC contamination.
- The scout platoon may assist the commander by occupying OPs or conducting patrols to provide a continuous flow of information about the enemy situation.

CONDUCT OF THE PASSAGE

In a forward passage of lines, the platoon leader or unit commander normally performs the coordination. For a rearward passage of lines, the PSG or the commander's liaison officer normally performs the coordination. The stationary unit is responsible for designating passage points and passage lanes and for providing guides. If contact points have not been designated by higher headquarters, the stationary unit should coordinate their locations with the passing unit. For ease of control, the passing unit's command group (TAC CP or main CP) temporarily collocates with the stationary unit's command group (TAC CP or main CP).

After coordination is made and the passage begins, guides pick up the passing unit at the contact point or passage point. Guides exchange recognition signals with the passing unit and move it along the route(s) without pausing, with the stationary unit overwatching the movement. Guides leave the unit either at the RP or after the movement has passed the last stationary unit position.

Disabled vehicles are recovered by self-recovery methods or by organic recovery vehicles. The stationary unit provides the required medical assistance, POL, and maintenance as far forward as possible. As a minimum, the stationary unit should provide emergency medical support.

NBC CONSIDERATIONS

Because of potential congestion of units at passage points and along routes, stationary and passing units must take protective measures against NBC attack. Techniques to reduce vulnerability include the following:

- To minimize exposure time, passing units move as rapidly as possible through passage points and along passage routes to their RPs.
- Passing and stationary units conduct radiological and chemical monitoring.
- Stationary units disperse by posting one or two vehicles in primary firing positions, with other vehicles in hide positions. Elements in hide positions prepare for NBC attack.
- Passing and stationary units put on chemical-protective clothing as prescribed by the commander.
- Stationary units request assistance through channels for decontamination of the passing unit, if required. Units normally conduct hasty decontamination and then move to a rear assembly area for deliberate decontamination. A scout platoon does not have the internal assets for deliberate decontamination of personnel or equipment; it requires assistance from a chemical defense company.

FRATRICIDE AVOIDANCE

Since battle handover and passage of lines are usually conducted in contact with the enemy, extreme care must be taken to avoid fratricide. Thorough coordination is critical; all units involved must know the correct recognition signals as well as the exact number of vehicles and time of passage. There will be times when some elements fail to receive necessary information or when stragglers are unaware of the current operation. Planning and coordination must cover the following considerations:

- Fratricide assessment.
- Vehicle marking systems.
- Navigational aids.
- Enemy situation and composition.
- Obscuration (limited visibility).
- IFF expedients for ground forces.
- Effective SOPs.
- Direct fire plans for both units.
- Indirect fire considerations, including specific procedures for requesting and clearing indirect fires.
- Communications procedures and potential problems.

For more detailed information on fratricide prevention and risk reduction measures, refer to [Chapter 2](#) (the discussion of situational awareness in [Section 4](#)) and [Appendix F](#) of this manual.

SECTION 4 — RELIEF IN PLACE

A relief in place is an operation in which one unit replaces another unit in combat. It may be

accomplished during offensive or defensive operations. The primary purpose of the relief is to sustain the combat effectiveness of committed units. It may also be conducted to allow a relieved unit to rest, reconstitute, or decontaminate or to change missions. For the scout platoon, the relief operation may entail such tasks as serving as road guides for the battalion task force, performing liaison with the relieved unit, or participating in the relief with its parent unit.

Relief in place is difficult to plan and conduct because of the nature of the operation and the command, control, communications, and coordination required. It is important that the operation not be disclosed to the enemy; security, secrecy, and speed are critical. Though the scout platoon cannot always wait for optimum conditions, relief in place is best conducted during periods of limited visibility and during lulls in battle. Limited visibility may be achieved by using smoke to obscure the enemy's vision. Using smoke over a large area can confuse the enemy as to the platoon's actual location.

The relief must be conducted as quickly and as secretly as possible. The relieving scouts must avoid sustaining casualties, hampering the operation of the scouts being relieved, or allowing the enemy to detect the operation. To reduce confusion and maintain security, the incoming platoon leader must attempt to obtain the following information:

- The time that responsibility for the sector or zone is to pass.
- Operations security (OPSEC) considerations.
- Deception plans.
- The time, method, and sequence of relief.
- Routes and critical control measures.
- Graphics for alternate and successive fighting positions.
- Contingency plans for changes of mission.
- Actions on enemy contact, if required before completion of the relief.
- Handoff procedures for artillery and ADA.
- Obstacle locations and procedures covering the transfer of responsibility.
- Procedures for transfer of ammunition, wire lines, POL, and other items between outgoing and incoming units, if necessary.

Radio traffic must be kept to a minimum; light and noise discipline must be strictly enforced. If possible, the relieving scout platoon leader conducts a reconnaissance of the new positions. This is usually accomplished with the relieved platoon leader.

Once the reconnaissance is complete and orders are finalized, the platoon executes its mission. If it is participating in the relief, one of several methods may be used:

- One vehicle at a time. This is the slowest, but most secure, method.
- All vehicles simultaneously. This is the quickest, but least secure, method.
- Occupying adjacent or in-depth positions that cover the same area of responsibility.
- Exchange of vehicles and equipment. This is done when secrecy is the overriding factor. This is the most difficult and time-consuming method.

The actual relief in place can be conducted from a hide position behind the relieved element, with individual relieving vehicles moving forward. The relieving platoon can also occupy alternate positions

within the relieved element's sector or zone. In some cases, the platoon may move into the primary positions as soon as the relieved vehicles back out. The relieved element may provide guides to ensure that relieving vehicles can locate those they are replacing.

The most important transmission during the relief process is the completion call to the incoming platoon's commander. This is made when the incoming platoon is fully set in position and is prepared to conduct its next operation.

CHAPTER 6

Combat Support

The scout platoon must take full advantage of available CS assets to accomplish its mission and to reduce its vulnerability on the battlefield. It may receive CS from mortars, field artillery (FA), ADA, combat engineers, GSR, and aviation assets. None of these assets are organic to the scout platoon, but they may be available through its parent battalion or cavalry troop. Scouts must understand the capabilities and limitations of the CS assets.

CONTENTS	
<u>Section 1</u>	<u>Indirect Fire Support</u>
<u>Section 2</u>	<u>Army Aviation</u>
<u>Section 3</u>	<u>Combat Engineers</u>
<u>Section 4</u>	<u>Air Defense</u>
<u>Section 5</u>	<u>Air Support</u>
<u>Section 6</u>	<u>Ground Surveillance Radar</u>

SECTION 1 — INDIRECT FIRE SUPPORT

Mortars and FA are the primary means of indirect fire support available to scout platoons. In addition to understanding the capabilities and limitations of these assets, scouts must know what fire request channels to use to request fires. The platoon leader must be prepared to work with the FIST at company team/troop level and the FSO at battalion/squadron level to plan and coordinate indirect fires. [FM 6-30](#) explains how to call for and adjust fires.

MORTAR SUPPORT

A mortar platoon of six tubes is organic to armor and mechanized infantry battalions. A mortar section is organic to the armored cavalry troop. Currently, mortar platoons are equipped with either 4.2-inch or 120-mm mortars. The 4.2-inch mortar has a maximum effective range of 6,840 meters. The 120-mm mortar has a maximum effective range of 7,200 meters.

Mortars can provide indirect fire support that is immediately responsive to the scouts' needs. They can provide a heavy volume of accurate, sustained fires. They are ideal weapons for attacking targets on reverse slopes, in narrow ravines or trenches, and in forests, towns, and other areas that are difficult to

strike with low-angle fires.

Types of mortar support

Mortars can be highly effective in providing the following types of support:

- **Suppression.** High-explosive (HE) rounds can be used to force the enemy to button up or move to less advantageous positions. Unless a direct hit is achieved, however, HE mortar rounds will not destroy armored vehicles.
- **Smoke.** White phosphorus (WP) rounds are used for obscuration and screening. Mortar smoke builds up more rapidly than artillery smoke. Obscuration is achieved by placing smoke on or just in front of enemy positions to obscure their vision. Screening is achieved by placing smoke between the enemy and the scout platoon position to conceal movement. Mortar smoke can also be used to mark enemy positions to enhance friendly maneuver and orient direct fires. Scouts must be careful, however, not to allow smoke to work against them by marking their own positions for enemy gunners.
- **Illumination.** Illumination rounds are used to light an area or enemy position during periods of limited visibility. Scouts can increase the effectiveness of their image intensification devices by using illumination. This helps them in gathering information, adjusting artillery, or engaging enemy targets. Ground-burst illumination can also be used to mark enemy positions and to provide a thermal target reference point (TRP) for control of fires. As with smoke, illumination is a double-edged sword; care must be taken not to illuminate friendly positions. Also, because US night vision devices are superior to those of most potential adversaries, illuminating the battlefield may be unnecessary or even counterproductive.

Capabilities

Mortar capabilities include the following:

- A close working relationship with scouts.
- Fast response time.
- Availability for low-density targets.

Limitations

Mortars have the following limitations:

- They have only short-range capability.
- Only limited types of ammunition are available.
- Mortar elements can carry only limited amounts of ammunition.
- The fire direction center (FDC) and mortar tubes are not linked to the initial fire support automated system (IFSAS).

FIELD ARTILLERY SUPPORT

Scouts must fully understand how to use artillery support to their best advantage. It is often their primary means of impeding and disrupting enemy formations and suppressing enemy positions. FA can provide immediate, responsive, accurate fires with a wide variety of munitions.

FA support is normally provided by an artillery battalion in direct support (DS) of a committed maneuver brigade or an armored cavalry regiment (ACR). The armored cavalry squadron also has an organic howitzer battery to provide dedicated indirect fire support. Scouts may receive FA priority of fire.

Capabilities

In support of the scout platoon, FA elements have the capability to perform the following functions:

- Provide fire support in all weather conditions and types of terrain.
- Shift and mass fires rapidly.
- Support the battle in depth with long-range fires.
- Provide a variety of conventional shell and fuze combinations.
- Provide continuous fire support by careful positioning and timely displacement.
- Be as mobile as the supported unit.

Limitations

FA support has the following limitations:

- Limited capability against moving targets.
- Limited capability to destroy point targets without considerable ammunition expenditure.
- Vulnerability to detection by enemy target acquisition systems because of its firing signature.

Available munitions

FA employs a wide variety of munitions that can be tailored for the engagement of different types of targets. These ammunition types include the following:

- HE, for use against personnel, field fortifications, and vehicles.
- Smoke, for obscuration and screening.
- Illumination.
- WP, for obscuration, burning, and marking.
- Cannon-launched guided projectiles (Copperhead), for use against point targets.
- Improved conventional munitions (ICM), for AP use, and DPICM, for use against personnel and light armored vehicles in the open. An important consideration is the danger to friendly troops in areas where AP munitions are fired. The potential dud rate of ICM makes maneuver in the area of an ICM field hazardous.
- Scatterable mines. These include area denial munitions for use against personnel and remote antiarmor mines for use against armored vehicles. When an FA battery is firing a scatterable mines mission, it is not available for other fire missions. Scatterable mines require slightly more lead time than do other FA-delivered munitions.

FIRE DIRECTION ASSETS

Fire support team

The FIST is attached to company teams or troops for combat operations; it may be pushed forward with

the scout platoon in support of security operations when on-target designation is required for special munitions engagements. The FIST's command and control link with the artillery makes it a valuable resource; it should not be exposed to direct fire except when absolutely necessary. The FIST is organized, equipped, and trained to provide the following:

- A fire support advisor and coordinator.
- A communications link to all available fire support assets.

The armor or mechanized infantry company team FIST normally monitors the following radio nets:

- Attached unit command net (battalion, company team, or scout platoon).
- Battalion mortar fire direction net.
- DS battalion fire direction net (digital).
- Battalion fire support net (voice).

The armored cavalry troop FIST normally monitors the following radio nets:

- Troop command net.
- Troop fire support net.
- Supporting artillery fire direction net (digital and voice).
- Squadron fire support net.

The FIST serves as the NCS on the troop fire support net. The FSE serves as the NCS on the maneuver battalion fire support net. The FIST relays the call for fire to supporting artillery on a digital net (IFSAS) or sends the fire mission to the mortar platoon or section. The command net allows the FIST to monitor unit operations and links the FIST to the commander and platoon leaders for planning and coordination.

Combat observation lasing team

Requests for indirect fire can also be sent through the COLT, which has a secondary mission of processing these requests for the scouts. The COLT monitors the scout platoon net and handles the fire request and subsequent adjustments in the same manner as a normal FIST. It can enter the information gained through its primary mission, lasing targets for Copperhead rounds and close air support (CAS), directly into IFSAS channels.

Three COLTs are organic to each DS FA battalion and to the howitzer battery of the armored cavalry squadron. The cavalry squadron has one organic COLT. From company/troop to brigade level, a COLT is placed under the control of a fire support coordinator to enhance the lasing capability of the FIST and to function as a dedicated observation platform (see [Figure 6-1](#)). When pushed forward with the scouts, the COLT should collocate with one of the scout platoon OPs for local security and protection.

 Combat Observation Lasing Team			
	Personnel		
	Number	Rank	Title
Mechanized Infantry/Armored Division	1	E5	Fire support sergeant
	1	E4	Fire support specialist
	1	E3	Fire support specialist
	Equipment		
	Number	Item	
	1	Full-tracked fire support vehicle	
3	Radio set AN/GRC-160		
1	Forward entry device		

Figure 6-1. COLT organization and equipment.

FIRE REQUEST CHANNELS

Battalion scout platoon

There are several ways the battalion task force scouts can request indirect fire. The task force SOP should specify which method they will use. The scout platoon leader must also coordinate with the task force FSO and/or FSE on which of these methods, described in the following paragraphs, the scouts will employ.

Mortar requests. The platoon can send requests for mortar fire directly to the mortars on the battalion heavy mortar net; the FSE monitors these requests. (See [Figure 6-2.](#))

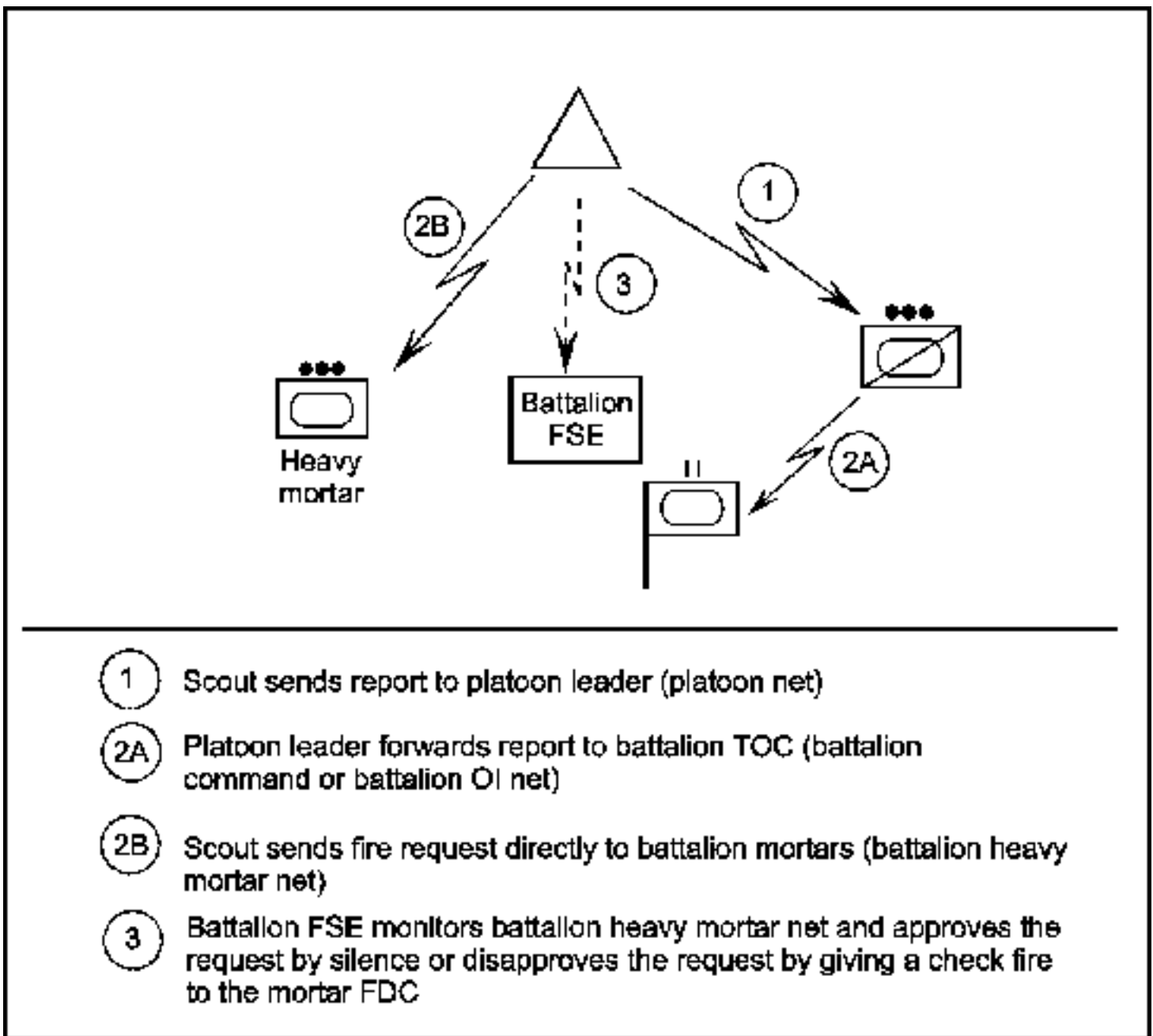

Figure 6-2. Scouts requesting fire from task force mortars.

Artillery requests. The platoon can send requests for artillery fire directly to the FA battalion on a fire direction net; the FSE monitors the requests. (See [Figure 6-3.](#))

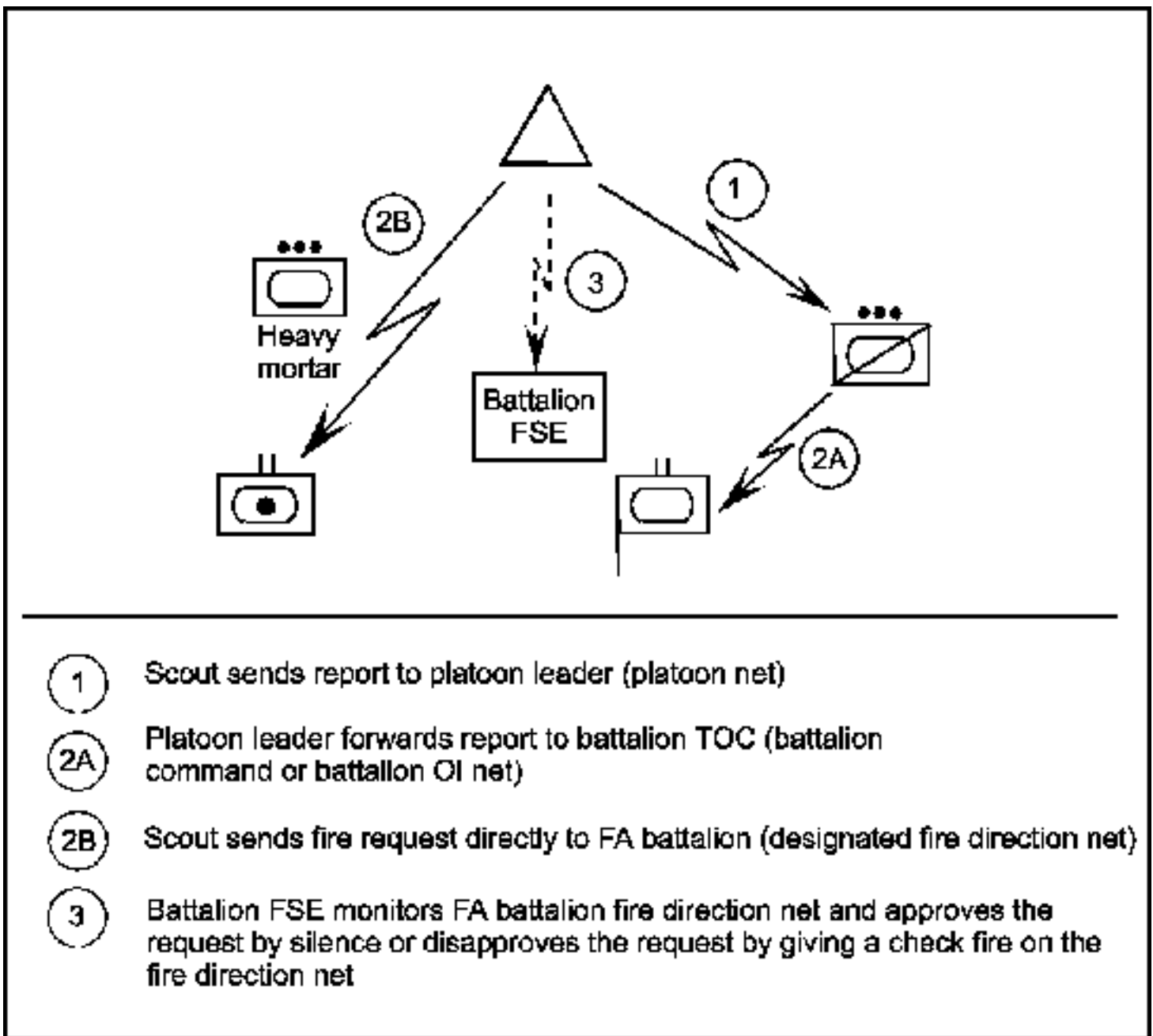
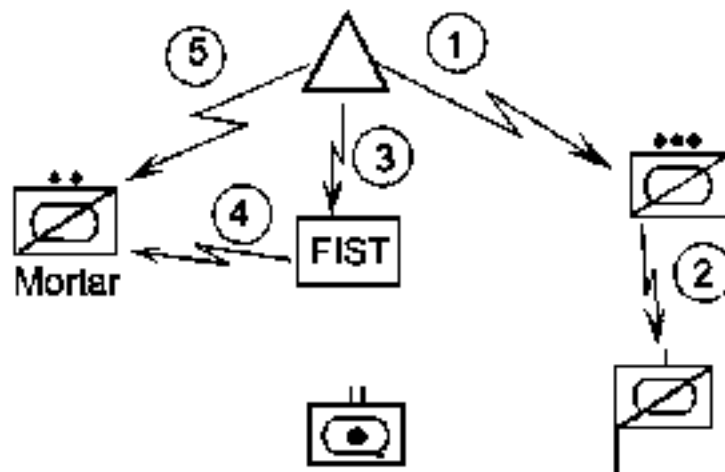

Figure 6-3. Scouts requesting fire from FA battalion.

Cavalry scout platoon

The scouts in an armored cavalry troop normally request all indirect fire support through their troop FIST on the troop fire support net. The FIST selects the best available fire support to engage the target. If the FIST passes the fire mission to the troop mortars, the scouts send all adjustments of the fire mission directly to the mortars (see [Figure 6-4](#)). If the FIST passes the fire mission to a supporting artillery unit, the scouts send all adjustments of the fire mission to the FIST, which relays the message to the artillery unit on a digital fire direction net (see [Figure 6-5](#)).



- ① Scout sends report to scout platoon leader (platoon net)
- ② Scout platoon leader forwards spot report to troop CP (troop command net)
- ③ Scout sends call for fire to troop FIST (troop fire support net)
- ④ FIST selects mortars to engage target (troop fire support net)
- ⑤ Scouts call mortars to adjust fire and end mission (troop fire support net)

Figure 6-4. Cavalry scouts requesting fire from mortars.

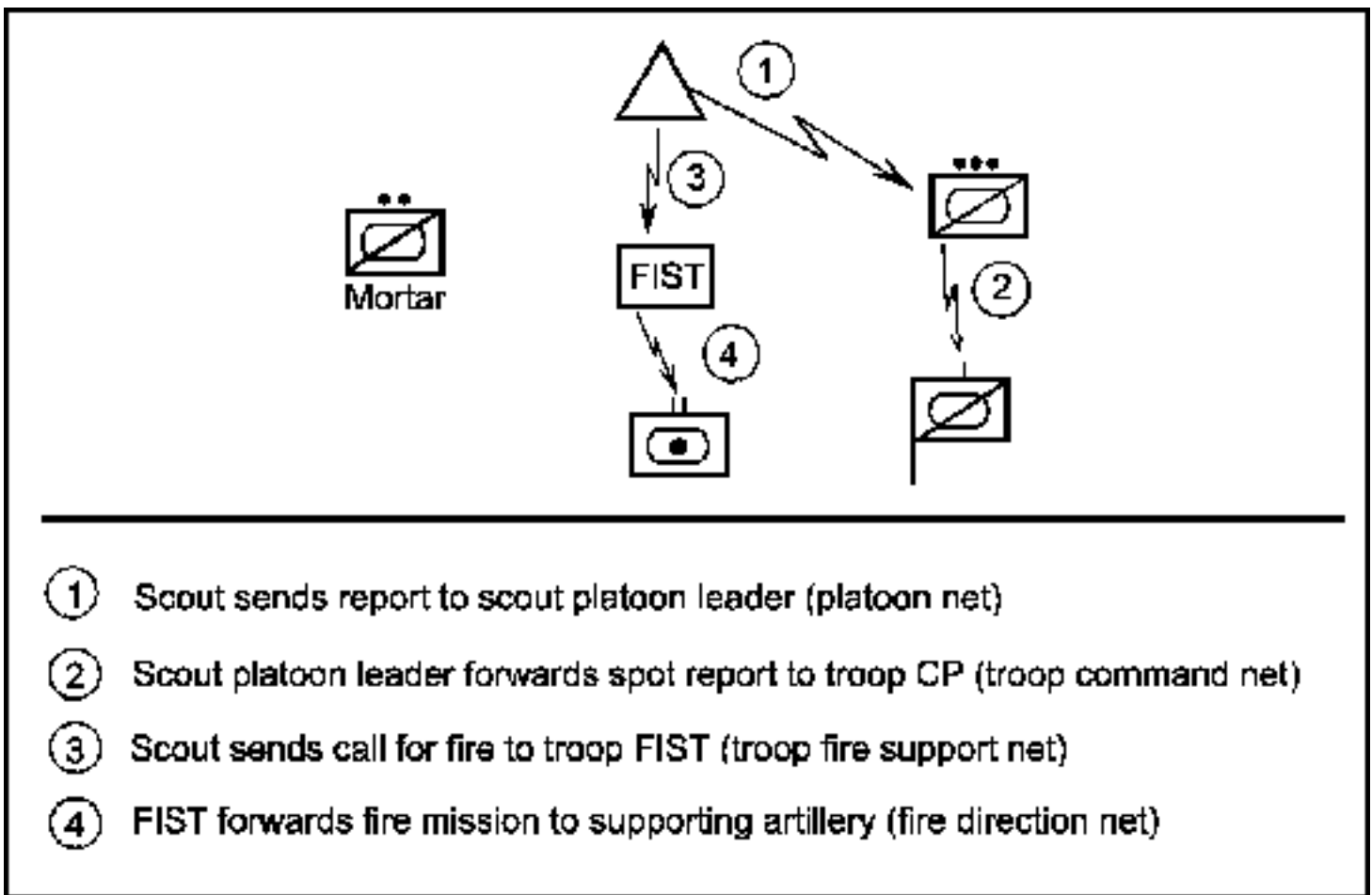

Figure 6-5. Cavalry scouts requesting fire from FA.

FIRE PLANNING IN SUPPORT OF SCOUT MISSIONS

The scout platoon leader must be prepared to use both hasty fire planning and deliberate fire planning in support of the platoon's missions. He should pay particular attention to the identification of priority targets and to the procedures used to shift priority targets whenever necessary. He forwards all planned targets in support of the scout mission to the FIST, which in turn forwards them to the FSO. (**NOTE:** The FSO provides the platoon information to the battalion commander and to brigade headquarters for verification and incorporation into the brigade fire support plan.) The nature of scout platoon operations dictates that primary consideration for fires should be focused on avenues of approach, OPs, and other key or decisive terrain.

The scout platoon leader coordinates priority of fires through normal fire support channels. He should concentrate on placing effective fires in several key locations: short of the LD/LC, from the LD/LC to the objective, on the objective, and beyond the objective (in case of enemy counterattack). He must also coordinate with adjacent units to ensure overlapping fires prior to execution of operations.

In the offense, the platoon leader uses these doctrinal targeting tasks when the scout platoon has target responsibilities. The two key areas of concern for the platoon will be short of the LD/LC and from the LD/LC to the objective. The fire support plan must also support the scout platoon during movement along assigned route and while it is occupying OPs; fires may be used against enemy reconnaissance elements or forward security elements. In the defense, the platoon leader must coordinate with the

battalion/squadron commander for planned targets and TRPs short of and beyond the FEBA.

During security operations, it is particularly important for the scout platoon leader to plan fires in support of point obstacles. The locations of obstacles should be refined and passed to the battalion and/or brigade fire support coordinator (FSCOORD) at the earliest possible time. The scout platoon leader should verify through the FSE or the FIST that the dedicated firing unit meets the requirements for accurate predicted fire. If the proper requirements do not exist, fires should be registered to ensure maximum effect when they are executed. As much as possible, the platoon leader should ensure the platoon has mortar priority of fire.

SECTION 2 — ARMY AVIATION

AIR CAVALRY

Scout platoons in regimental squadrons and divisional cavalry or reconnaissance squadrons must establish a close working relationship with air cavalry troops. Through its mobility and speed, air cavalry gives the ground commander or scout platoon leader added flexibility, increasing the speed with which reconnaissance is conducted. Aeroscouts also can screen between and forward of OPs established by the platoon. (See [Figure 6-6](#).)

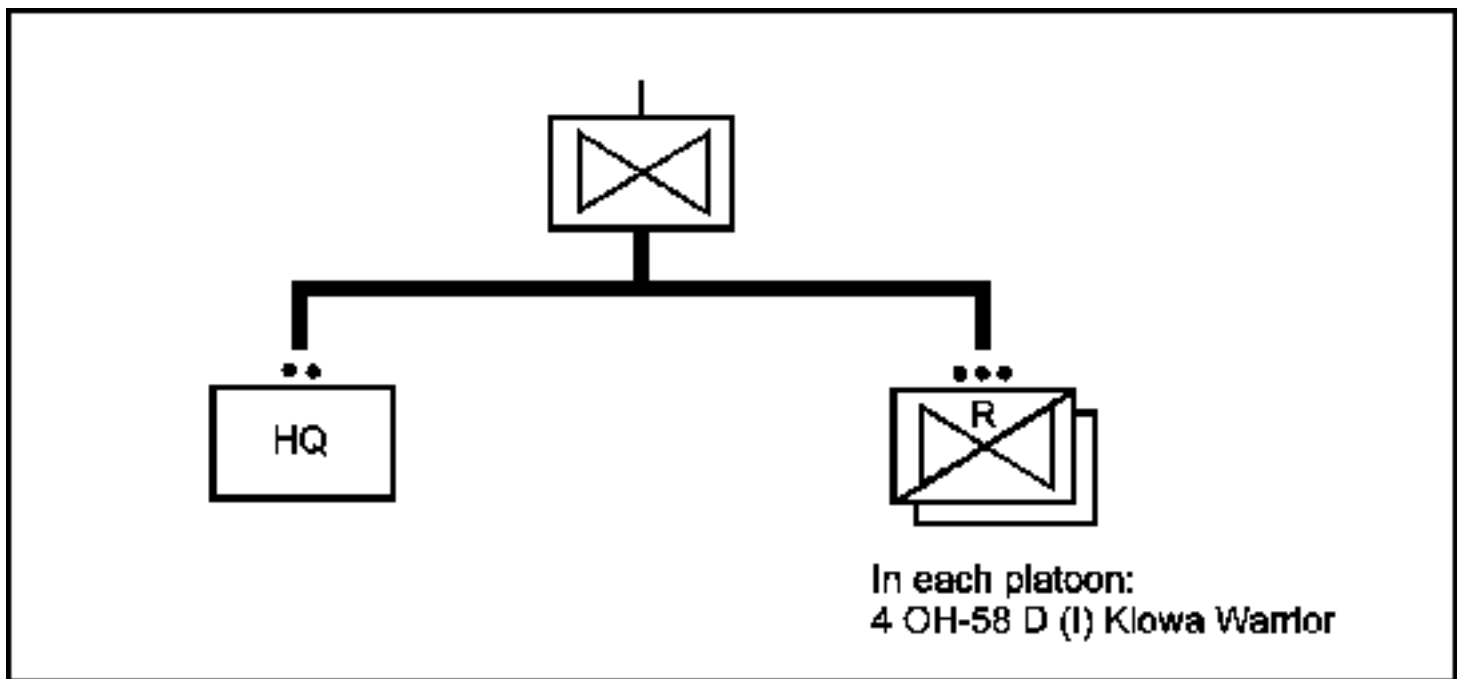

Figure 6-6. Air cavalry troop organization.

The areoscout platoon consists of four aircraft, led by a lieutenant. It includes a flight examiner, instructor pilot, and individual aircraft pilots. Its primary mission is to conduct armed reconnaissance and surveillance missions.

The primary aircraft in air cavalry units is the OH-58D(I) Kiowa Warrior. This helicopter provides the maneuver commander with a versatile platform; it can be armed with various weapon systems and is suitable for employment in numerous types of situations and operations.

The aircraft features a stabilized mast mounted sight (MMS) with a low-light TV camera, thermal imaging system, and laser range finder/designator. The air crew of the Kiowa Warrior can detect a heat source in day or night conditions at a range up to 15 kilometers and is capable of providing laser designation of targets for laser-guided munitions. [Figure 6-7](#) illustrates the aircraft's armaments.

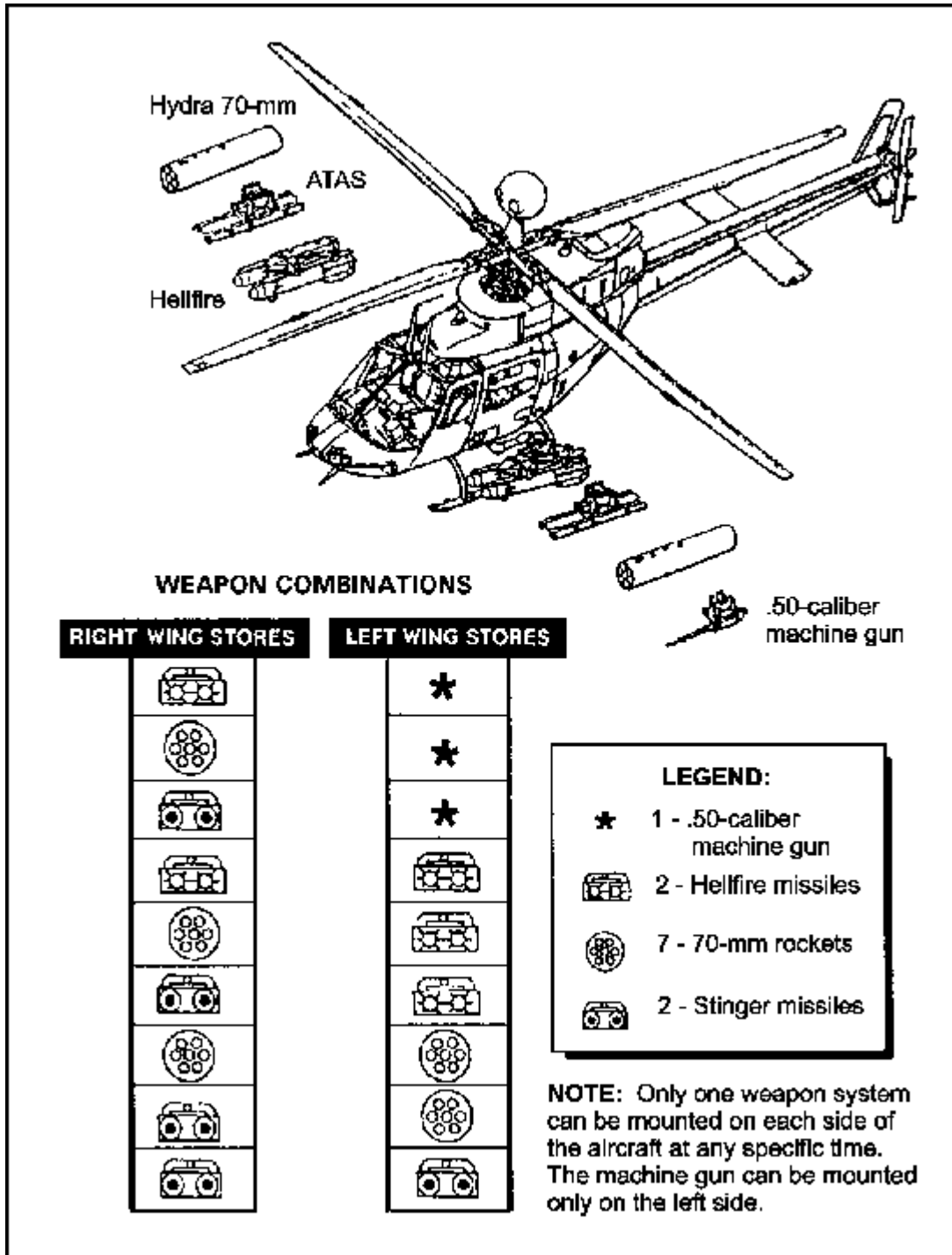

Figure 6-7. OH-58D(I) Kiowa Warrior.

NOTE: The Kiowa Warrior's detection and identification capabilities and its maximum operational and weapons ranges can be significantly affected by such factors as terrain, weather, and crew experience.

ATTACK HELICOPTERS

The attack helicopter battalion conducts attack, reconnaissance, and security operations that complement the operations of other maneuver forces. (See [Figure 6-8.](#)) When effectively integrated in the tactical maneuver plan with other maneuver units, the battalion is a valuable combat asset for the supported unit commander. Its capabilities enable him to mass combat power rapidly at the decisive time and place to affect the battle's outcome, striking the enemy where and when he is most vulnerable.

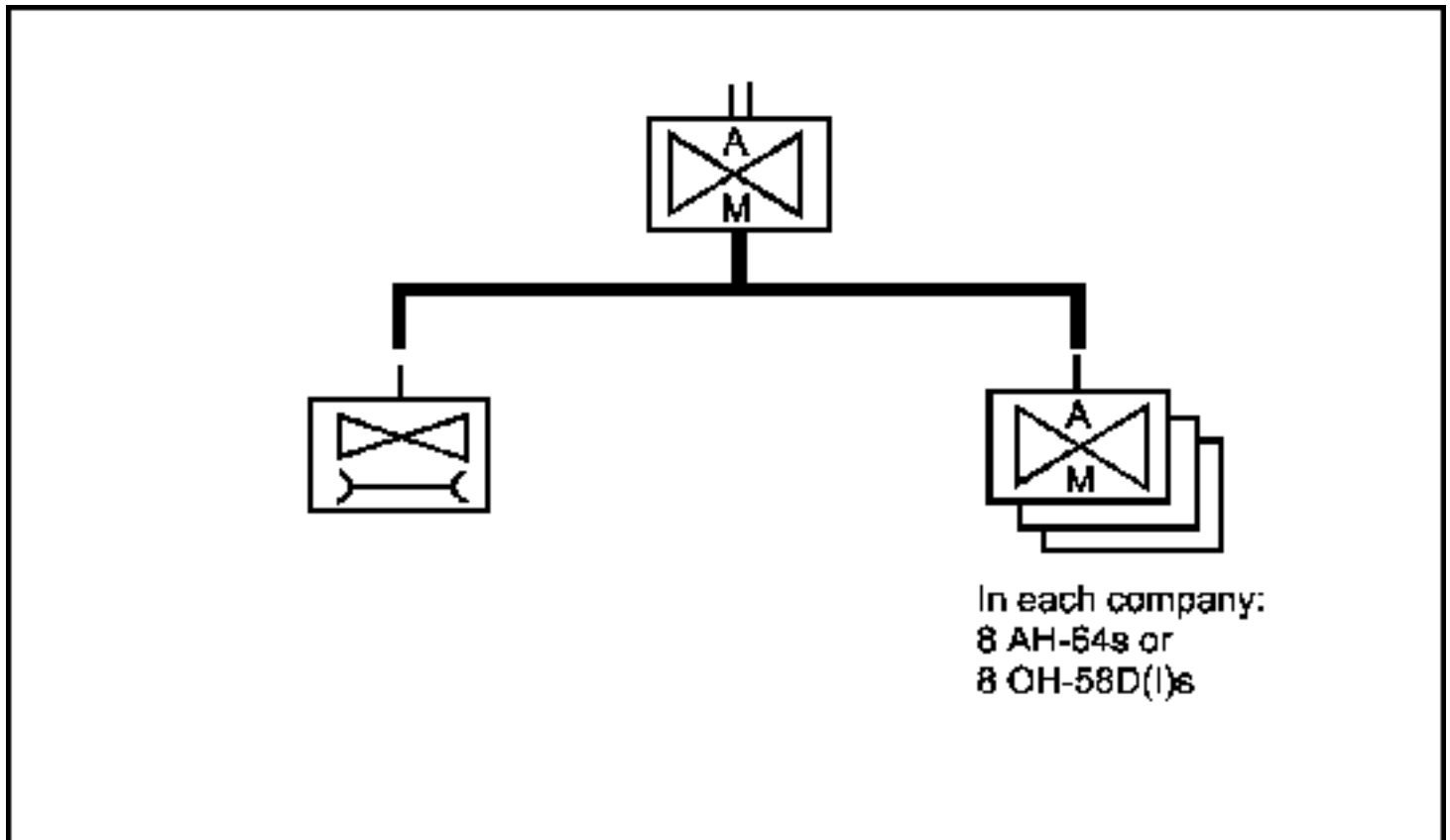

Figure 6-8. Attack helicopter battalion organization.

An attack helicopter battalion seldom fights alone; it is normally employed with other maneuver, CS, CSS, and joint forces in a combined arms team. This team surprises and overmatches the enemy at the point of attack. The attack helicopter unit may conduct its attack out of physical contact with other friendly forces but synchronized with their scheme of maneuver; it may also be employed in direct contact with friendly forces.

AIR CAVALRY AND THE SCOUT PLATOON

The Army aviation element with which the scout platoon is most likely to operate in a tactical setting is the air cavalry platoon or air cavalry troop. When operating with ground scouts, air cavalry is normally under the operational control of the battalion or squadron. To be successful, however, the air cavalry platoon must communicate and coordinate directly with the most forward ground scouts.

Aeroscouts are a significant asset in support of the ground commander's requirements for his scout effort. Complementing ground scouts with the air cavalry maximizes the capabilities of both elements while minimizing their limitations. When it works with the scout platoon, the air cavalry normally operates 3 to 5 kilometers forward of the ground elements (see [Figure 6-9](#)).

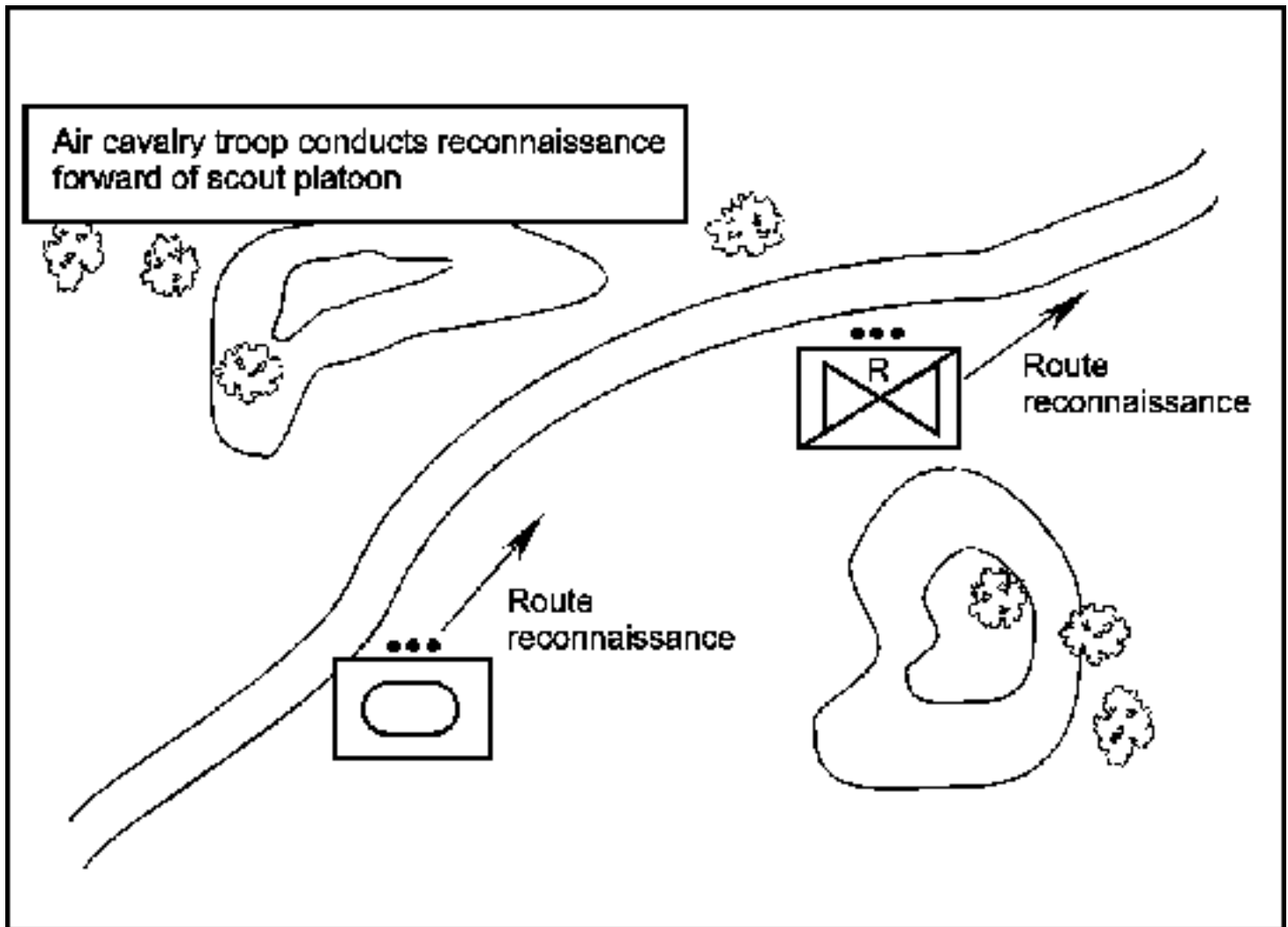

Figure 6-9. Air cavalry operating forward of the scout platoon.

In a complementary relationship, air cavalry and ground scouts are assigned different objectives or tasks; they work independently as required to support their common commander. This permits a greater number of tasks or separate missions to be accomplished simultaneously. Often, air cavalry complements ground scouts by performing missions to the flank of or adjacent to the scout platoon (see [Figure 6-10](#)).

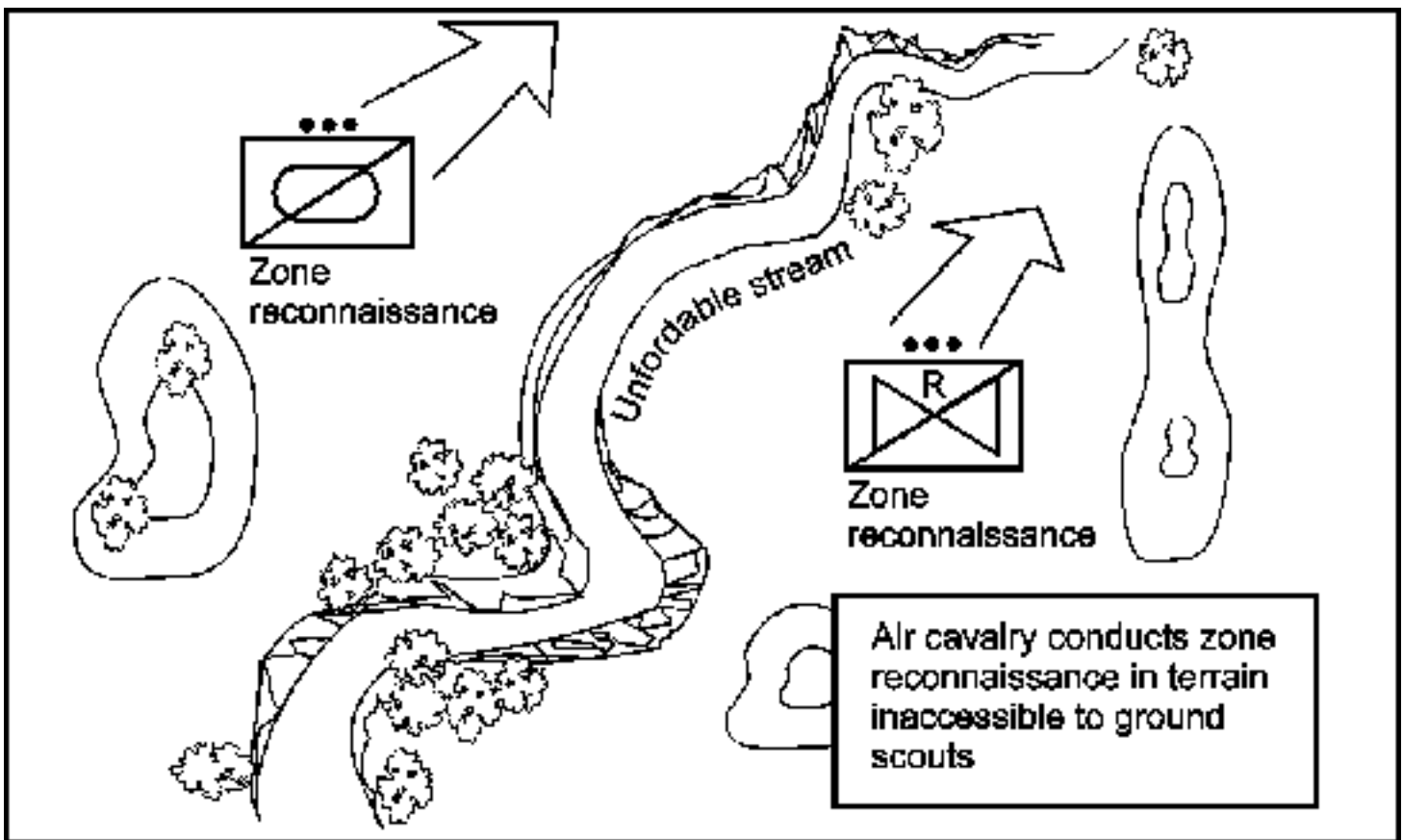

Figure 6-10. Air cavalry operating on the scouts' flank.

COMMAND AND CONTROL

Command and control is essential to effective air-ground coordination. The command relationship is particularly critical when air and ground elements are complementing each others' operations. Two different command relationships can be used to coordinate the efforts of air cavalry and the scout platoon: the scout platoon under OPCON of the air troop or both the scout platoon and the air element working independently for a common higher commander.

Although air elements are not placed OPCON to the scout platoons, the ground scouts and air assets must closely coordinate their actions. The situation will determine whether the air mission commander is the air cavalry troop commander or an air cavalry platoon leader.

Scout platoon under operational control of the air commander

The OPCON relationship is used when the scout platoon is operating separately from its parent unit with an air cavalry troop. The air cavalry troop has the preponderance of combat power, leadership, and command and control resources in the area of operations. In addition, it has superior long-range communications capability.

Air and ground scouts under control of a common commander

This relationship is the most common and is usually the most effective. The air and ground scouts operate independently, allowing each to freely and quickly employ its elements to take maximum advantage of their unique capabilities. Further, the common commander, normally at battalion or

squadron level, can ensure that guidance is provided to both air and ground scouts so their efforts are coordinated.

In this relationship, informal coordination also occurs directly between the ground scout and the air cavalry platoon. This is done over the ground scout platoon net.

RECONNAISSANCE OPERATIONS

When air cavalry complements the scout platoon during reconnaissance operations, the air assets, as noted, normally operate 3 to 5 kilometers forward of the platoon. They focus on areas where they can impede enemy ground movement. In addition, the air cavalry can conduct detailed reconnaissance of areas that are particularly dangerous to ground reconnaissance elements, such as open areas and defiles. Upon contact, air cavalry provides early warning for the trailing scout platoon and then maintains contact until the scout platoon moves up for handover.

SECURITY OPERATIONS

Air cavalry can complement the scout platoon during security operations by assisting in identifying enemy reconnaissance and main body elements and providing early warning forward of the platoon. Because of the range of its sensors, air cavalry does not require positions forward of the scout platoon to acquire enemy elements. The preferred practice, however, is still to position the aerial OPs forward of the ground OPs to provide added depth to the screen, especially during daylight operations. During limited visibility, aerial OPs may be deployed slightly to the rear of ground elements. Ultimately, positioning of the air cavalry will always depend on the specific METT-TC situation. [Figure 6-11](#) illustrates positioning of the air cavalry.

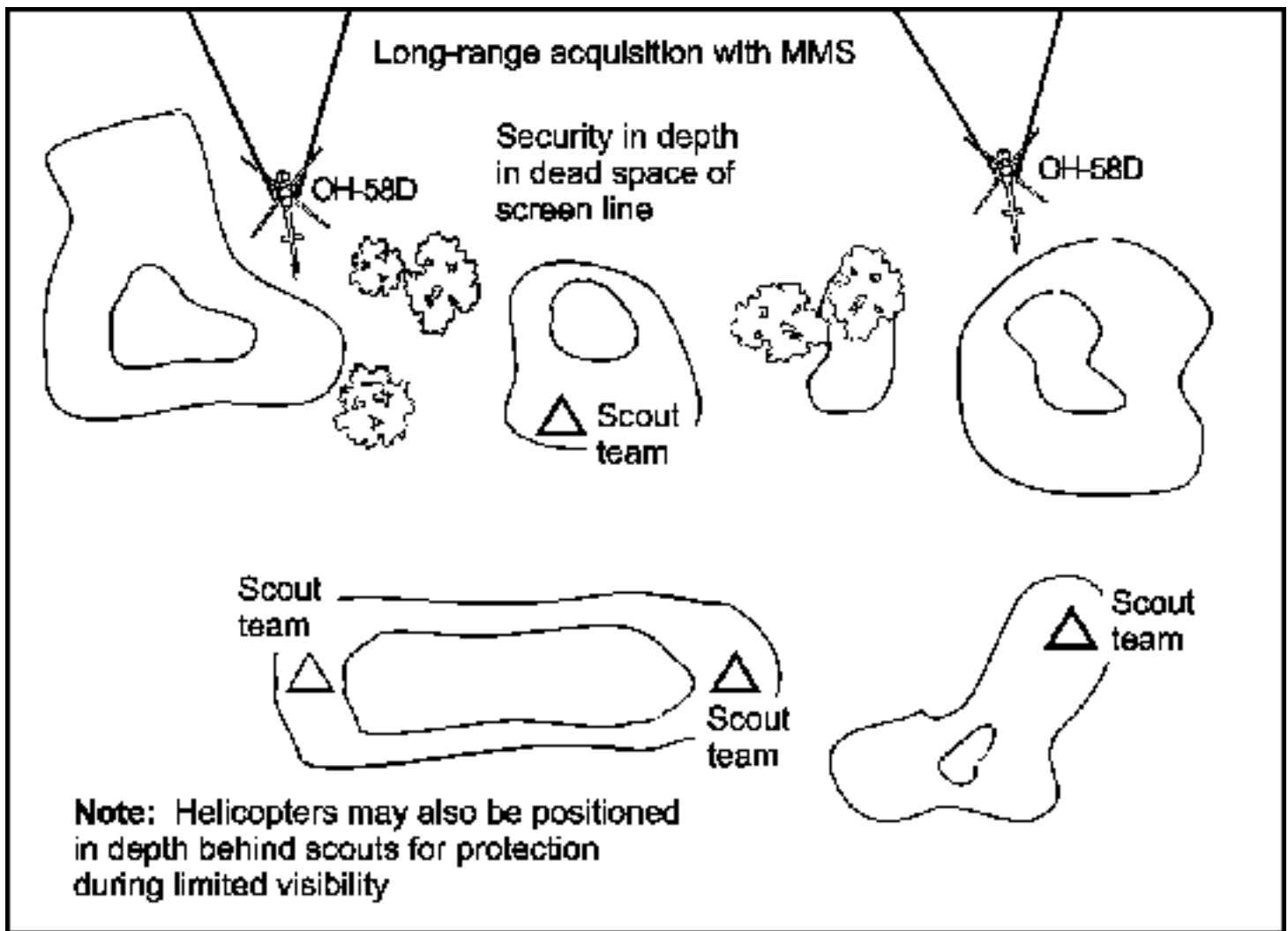

Figure 6-11. Figure 6-11. Air cavalry complementing a ground screen.

In addition to acquiring enemy elements, air cavalry can play a critical role in providing security through the depth of the screen by observing dead space between OPs. The aerial assets can also assist ground elements in the counterreconnaissance fight.

AREA SECURITY

Air cavalry elements can complement the scout platoon during area security missions by screening or conducting reconnaissance. An air screen can provide early warning for a scout platoon executing a convoy escort mission or securing a critical point (see [Figure 6-12](#)). Air reconnaissance assets can identify enemy ambush positions forward of the convoy or find bypasses the convoy can use to move around an obstacle (as illustrated in [Figure 6-13](#)).

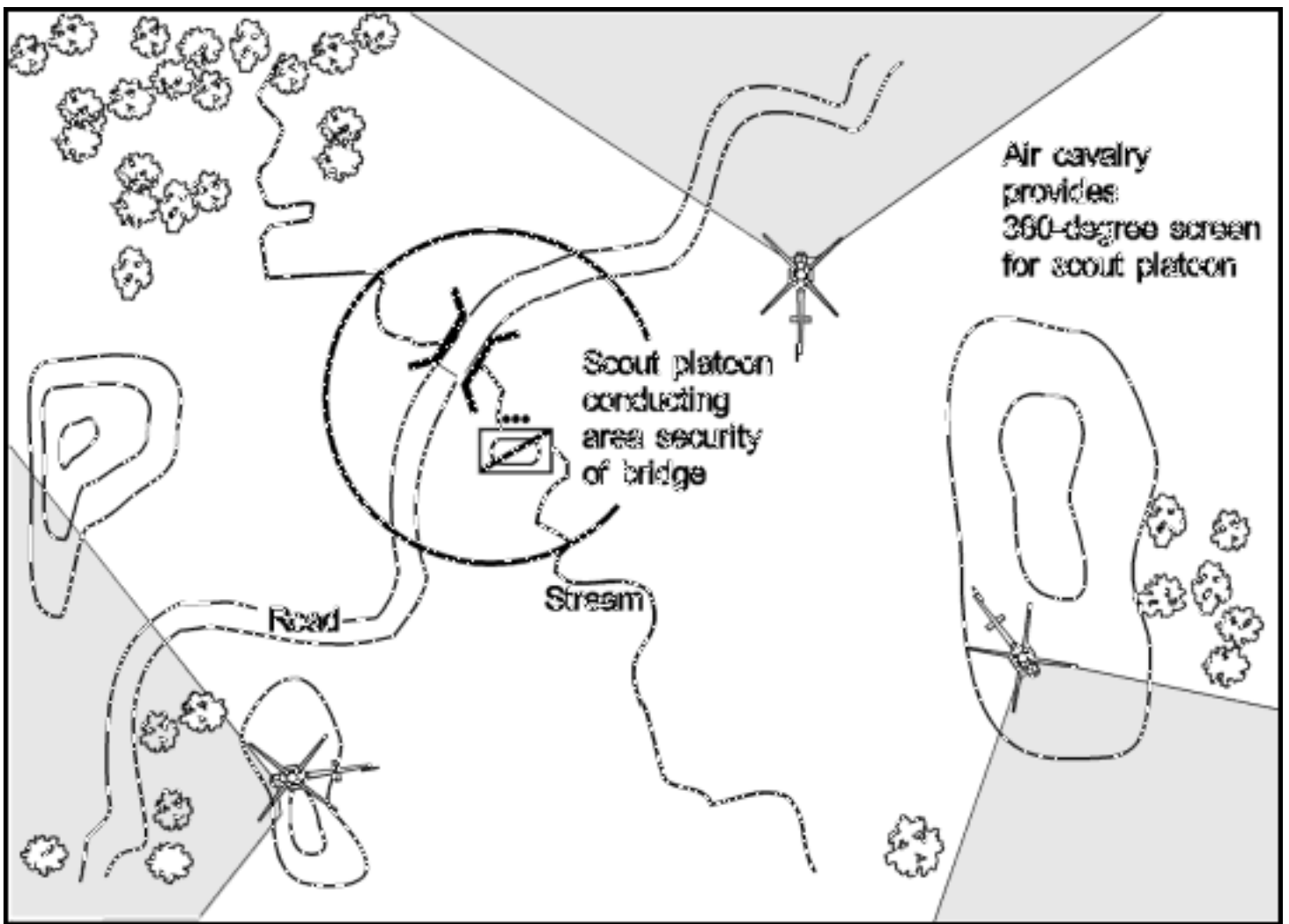

Figure 6-12. Air cavalry screening for a scout platoon.

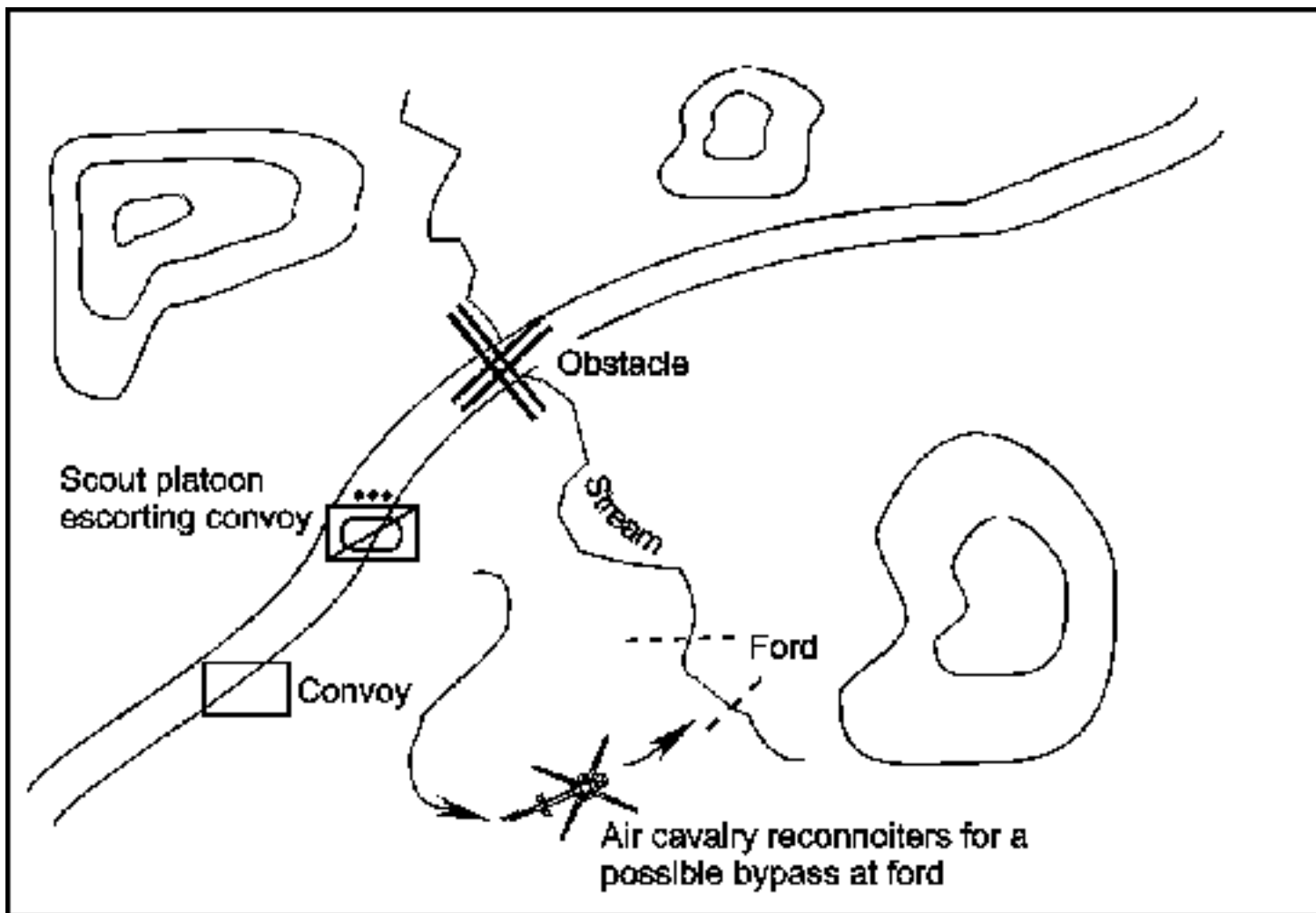

Figure 6-13. Air cavalry reconnoitering for a bypass.

AIR-GROUND BATTLE HANDOVER

When an air cavalry platoon makes contact, particularly during reconnaissance operations, it attempts to hand off the contact to ground scouts as quickly as possible. A speedy handover allows the air scouts to avoid enemy air defense weapons and also helps to maintain the tempo of the operation.

During the handover, the air cavalry platoon is in charge and provides direction to the ground scout section or squad charged with establishing contact with the enemy. The air cavalry also is responsible for ensuring the protection of both ground and air scouts; it must maintain contact with the enemy until the ground unit is in position and has also established contact.

The first action in the handoff process is a spot report (SPOTREP) and situation report (SITREP) from the air cavalry platoon team leader to the ground scout section or squad leader. The two leaders also determine the time and place for linkup between their elements (see [Figure 6-14A](#)).

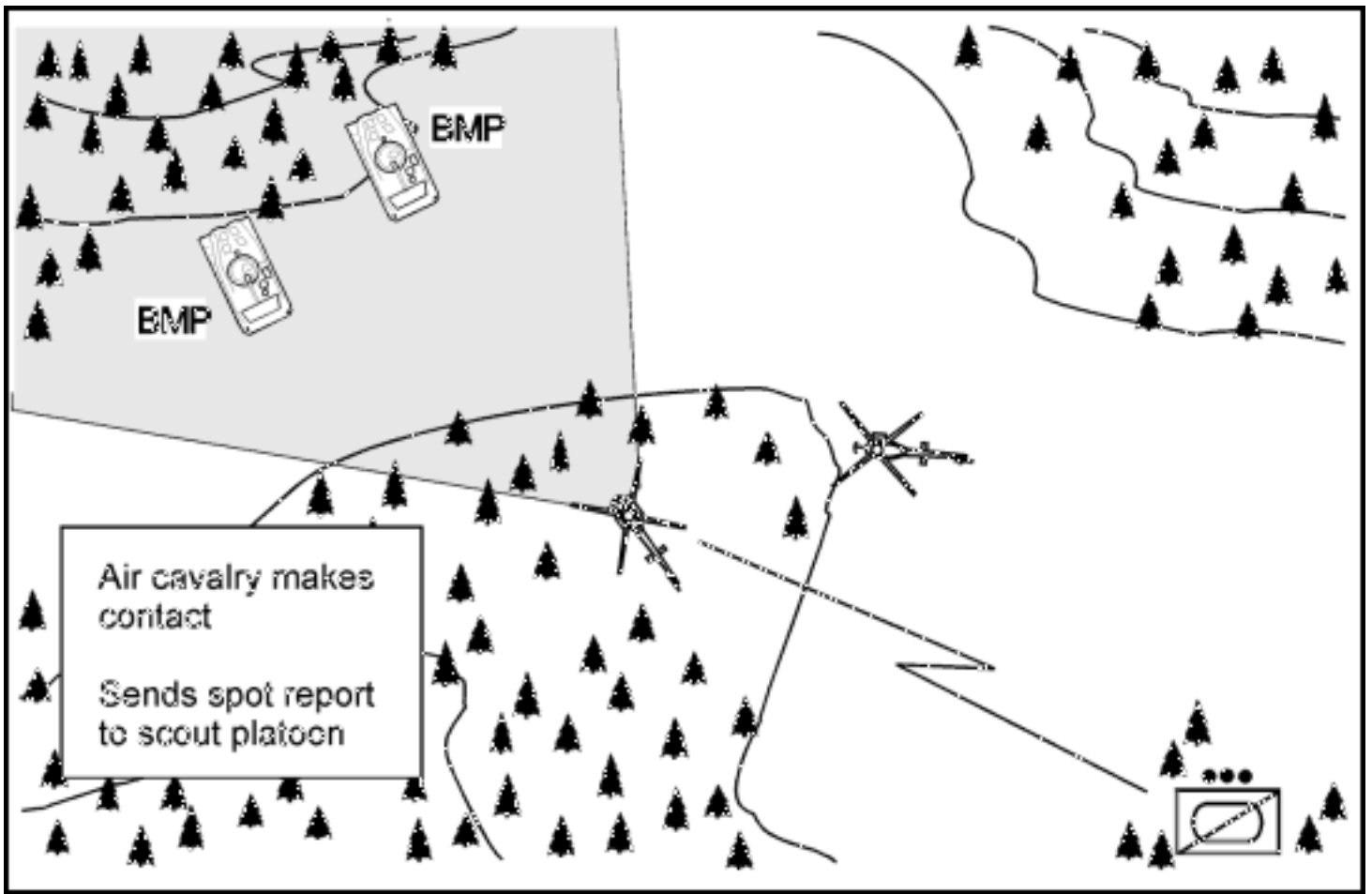

Figure 6-14A. Air-ground battle handover.

Next, the air cavalry platoon leaves an element in contact with the enemy while it reconnoiters the area for secure positions for the ground scouts. The air cavalry platoon identifies hide positions, overwatch positions, OP positions, and mounted and dismounted routes into the area (refer to [Figure 6-14B](#)).

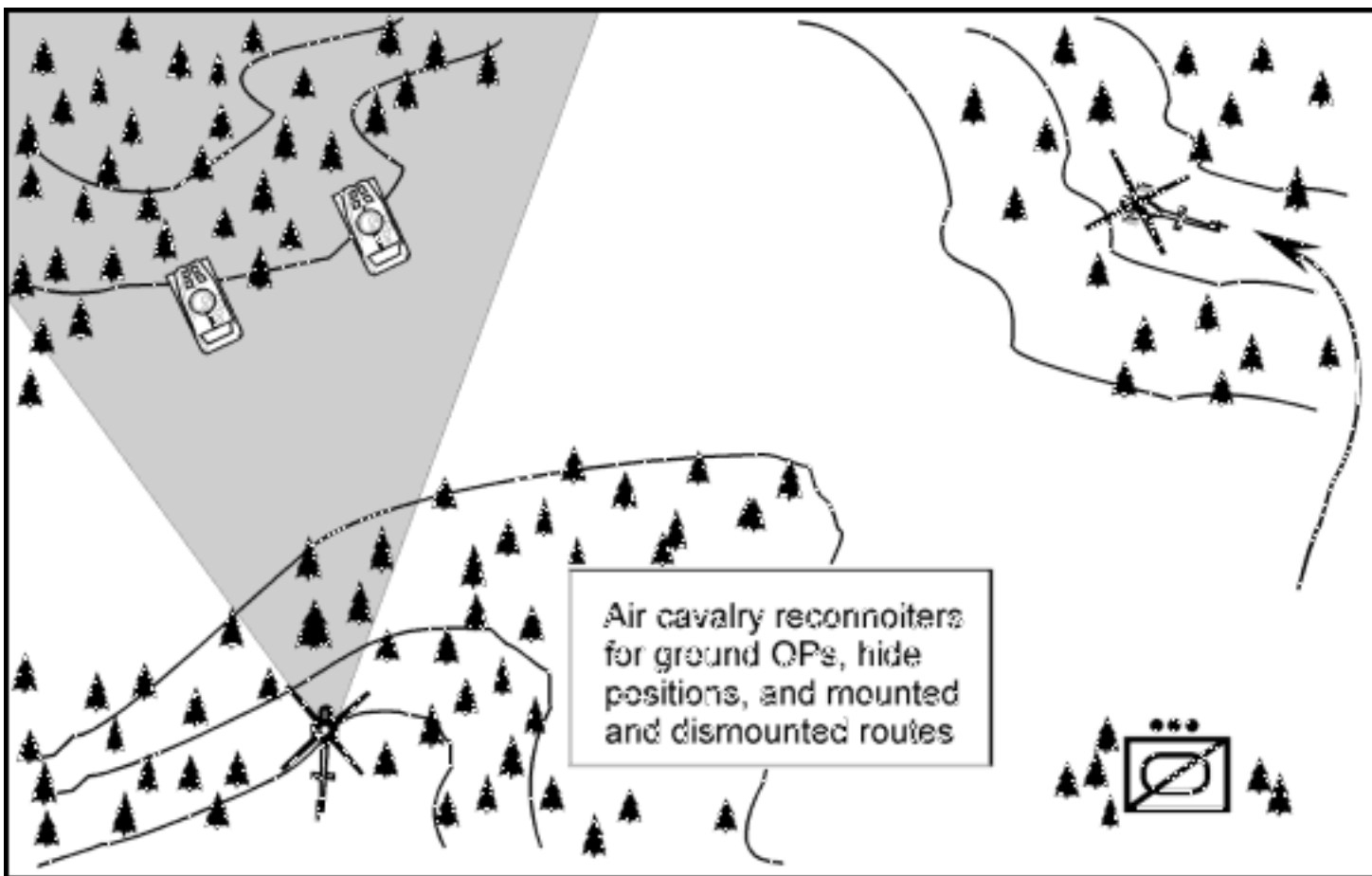

Figure 6-14B. Air-ground battle handover (continued).

Once this is complete, the air cavalry platoon moves to link up with the ground scouts. Ideally, the air mission commander should land and brief the scout section or squad leader face-to-face. If this is not possible, the briefing is done over the radio. Linkup is complete when both elements have visually identified each other (see [Figure 6-14C](#)).

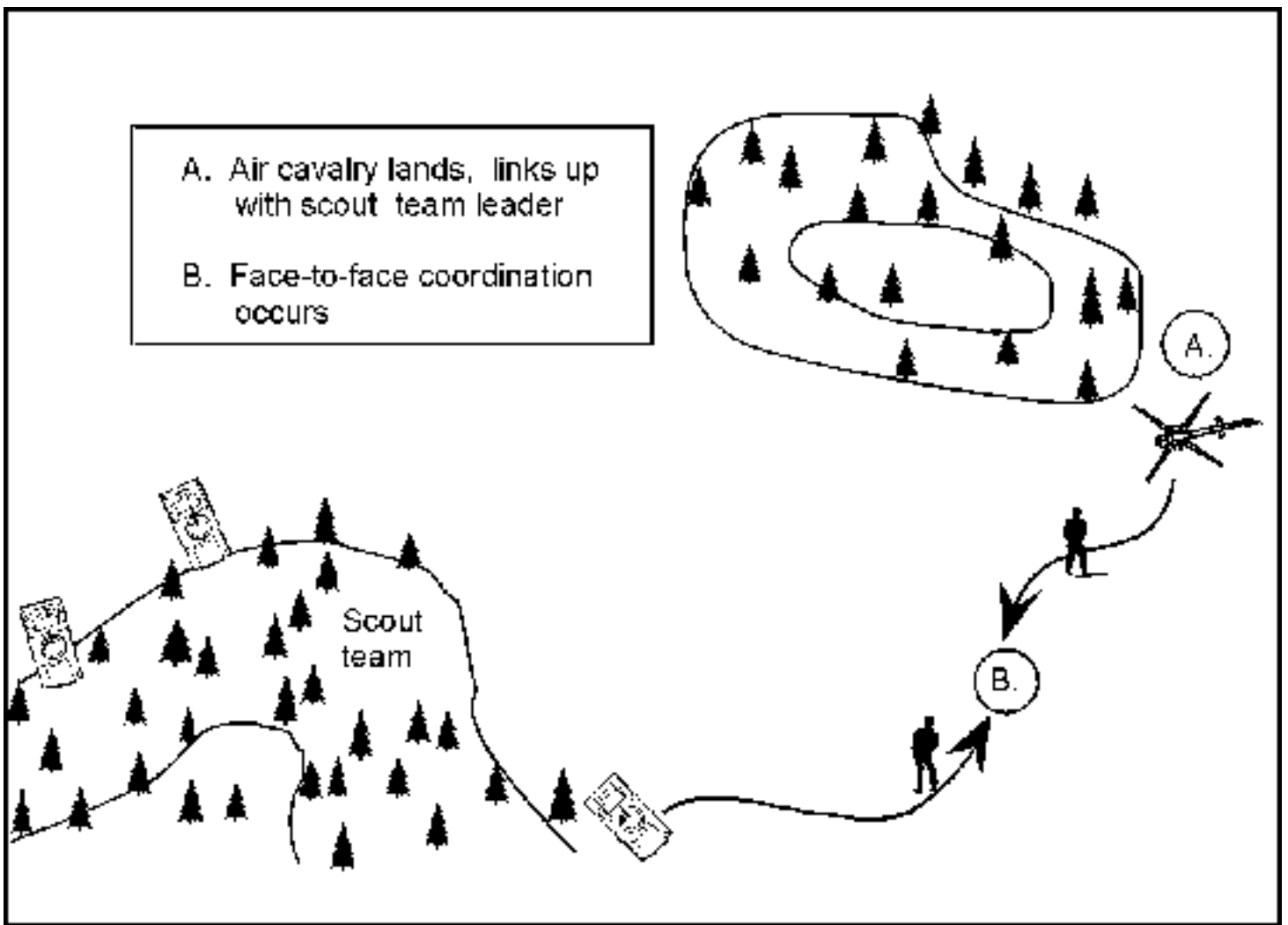

Figure 6-14C. Air-ground battle handover (continued).

After linkup, the ground section or squad moves to its initial hide positions along the route selected by the air cavalry platoon. Scouts then move dismounted to make contact with the enemy. Once contact is established, the ground scout leader sends a SPOTREP to the air mission commander. When the air commander confirms that the ground scouts can observe all enemy elements and have a clear picture of the situation, he announces that handover is complete; the ground section or squad leader acknowledges the transmission.

The air scouts then assist the ground unit in executing its chosen COA (such as bypass, fix, destroy, or develop the situation). After handover is completed, the air scouts may, if directed, break contact and continue their follow-on missions. As noted previously, the battle handover sequence is executed on the ground unit's internal frequency. (See [Figure 6-14D](#)).

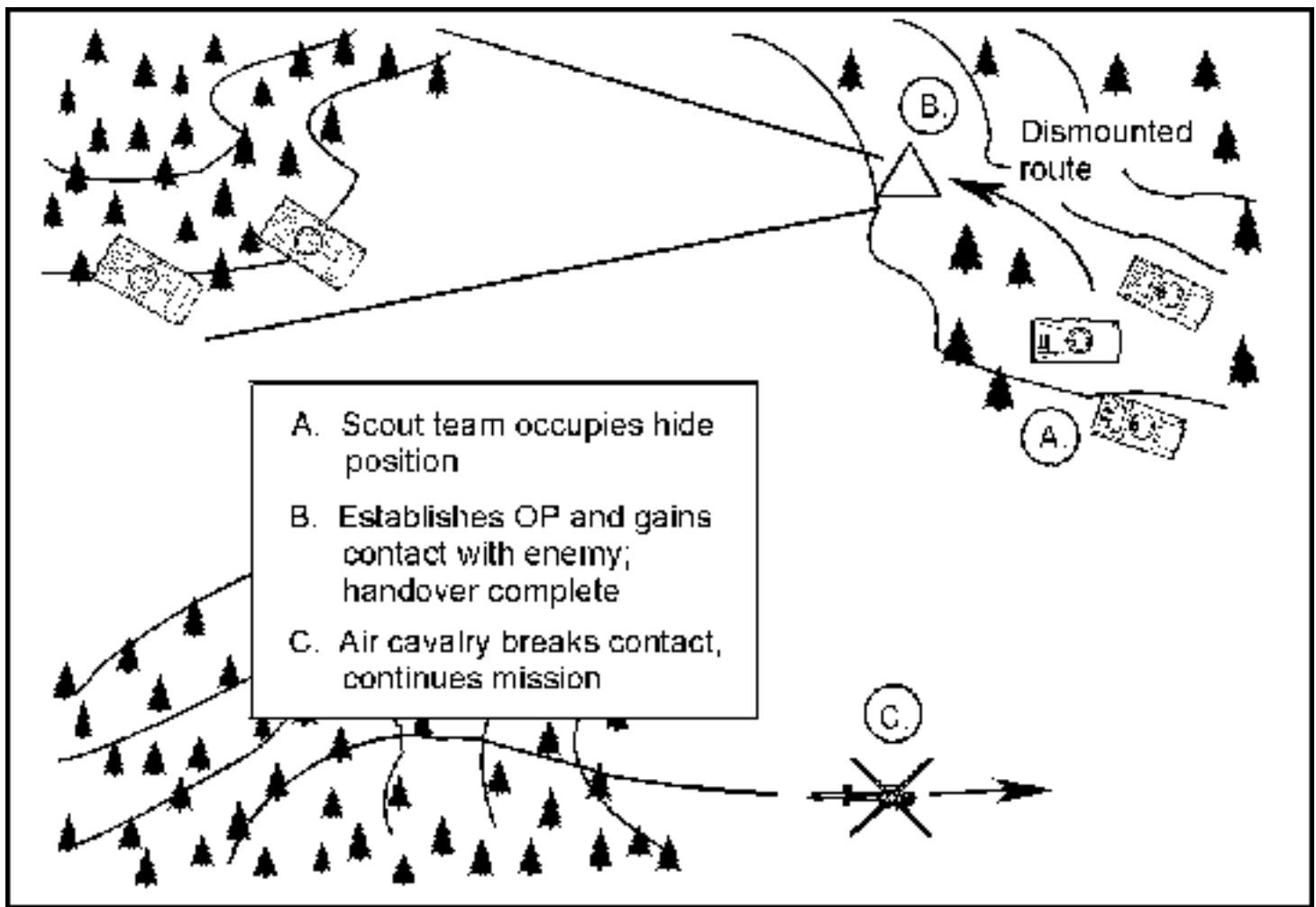

Figure 6-14D. Air-ground battle handover (continued).

SECTION 3 — COMBAT ENGINEERS

Brigade/regiment and battalion/squadron commanders will decide how best to use their engineer assets. They have several options for engineer employment: as a distinct unit, attached to higher unit's subordinate elements, or in DS of the subordinate elements.

In offensive operations, engineers are task organized to maneuver units using the breaching operation planning process, based on both templated and confirmed enemy obstacles. One technique is to attach engineers to the lead company team or to a troop in a counterobstacle team configuration. In the defense, commanders generally keep engineer units intact to construct major obstacles, designating a priority of work to be accomplished.

Engineers are trained to fight as infantry as a secondary mission; however, they are employed as infantry only if absolutely necessary. Only a commander who maintains a command relationship with the engineer element can make this decision. The basic engineer unit with which the scout platoon is likely to operate is a sapper squad from a combat engineer platoon.

ENGINEER SUPPORT IN RECONNAISSANCE

In reconnaissance operations, an engineer reconnaissance team may be placed in DS to a scout platoon. The engineers should remain attached to the scout platoon for the duration of the reconnaissance. The engineer team's primary objective is to collect OBSTINTEL and report the information back to the task force engineer to facilitate breach planning and preparation. The engineer team may perform the following functions:

- Conduct tactical or technical reconnaissance.
- Conduct route and bridge classification.
- Assist in locating bypasses around obstacles.
- Identify the exact composition and dimensions of an obstacle.
- Conduct limited reduction of log cribs, abatisses, and minefields. The engineer reconnaissance team's actual reduction capabilities are limited to manual and explosive methods. The scouts must provide security for the engineer team while it is reducing obstacles.

Engineers conduct tactical reconnaissance in the offense as part of the combined arms team reconnaissance effort; normally, they are attached to scout elements to facilitate command and control and logistical support. The engineers' key tactical reconnaissance objective is to provide the commander with OBSINTEL within the area of operations. This information, combined with intelligence obtained by the scouts, allows the combined arms force to maneuver more effectively against the enemy. It tells the commander whether a bypass is possible or, if not, how to conduct breaching operations with the right equipment at the right location.

Engineers conduct technical reconnaissance to collect specialized information about a designated target, area, or route. This mission is usually conducted under a low level of threat in areas physically controlled by friendly forces to the rear of the FLOT. The technical reconnaissance mission is normally a specified task from higher headquarters or is derived from mission analysis.

Whenever possible, engineer elements should have a habitual relationship with the scouts to whom they are attached. They should be task organized with scouts as early as possible in an operation so they can be integrated into the scout platoon leader's troop-leading procedures, rehearsals, OPORD, and movement plans.

ENGINEER SUPPORT IN SECURITY OPERATIONS

In security operations, the scout platoon does not usually have any engineer assets operating under its control. Engineer assets normally work under battalion, squadron, or troop control. The scout platoon leader must have access to the battalion, squadron, or troop obstacle plan, including the locations of lanes and gaps.

Scout platoons may be designated to observe NAIs to trigger scatterable mine missions, overwatch obstacles, and call for indirect fires. They also may be designated to guard, execute, and overwatch reserve demolition targets that engineers have prepared. The process by which the platoon assumes responsibility for the targets is called target turnover. Procedures and considerations for this mission are as follows:

- Prior face-to-face coordination between the senior member of the emplacing unit (normally an engineer squad leader) and the demolition guard force commander (normally a scout squad leader) speeds the turnover process. Prior coordination is always conducted if the tactical situation permits.
- The senior member of the emplacing unit must require positive identification from the demolition guard commander. This may be by means of sign/countersign procedures or by personal recognition.
- Once identification is established, the emplacing unit gives the demolition guard commander a completed target folder for the target being turned over. The folder contains orders to the demolition guard commander (and to the firing party commander, if one is separately designated). The demolition guard commander reviews the orders to ensure he thoroughly understands them and then signs the orders.
- The senior member of the emplacing unit then describes the obstacle in detail to the demolition guard commander.
- Once the demolition guard commander fully understands his responsibilities and he (or the firing party commander, if applicable) is capable of executing the target, the emplacing unit may depart to conduct further operations.

SECTION 4 — AIR DEFENSE

Air defense assets are scarce; maneuver units cannot plan on always receiving dedicated air defense protection. Consequently, the scout platoon must be able to protect itself from enemy air attacks during all combat operations. Passive air defense measures employed by the platoon include actions to avoid detection and air attack and actions to limit the damage if attacked. If necessary, the platoon takes active air defense measures to fight back against the enemy aircraft.

The scout platoon must be aware when the enemy is employing airborne reconnaissance, intelligence, surveillance, and target acquisition (RISTA) systems that can detect and pinpoint the location of friendly ground forces. These systems emphasize rapid downlink of collected information to artillery and tactical ballistic missile (TBM) fire control centers and enemy maneuver forces.

Armed utility and attack helicopters are the principal enemy CAS weapon systems. These platforms pose a major threat to the scout platoon and other friendly forces. The enemy may also employ unmanned aerial vehicles (UAV) to accomplish RISTA, attack, and deception missions; UAVs' small size and radar cross section and their ability to fly low and slow make them very difficult to detect track and engage.

PASSIVE AIR DEFENSE

Passive air defense is the scouts' first line of defense against enemy air attack. It includes all measures, other than active defense, taken to minimize the effects of hostile air action. There are two types of passive air defense: attack avoidance and damage-limiting measures.

Attack avoidance

If the enemy pilot cannot find you, he cannot attack you. Scouts use concealment, camouflage, deception, and any other necessary action to prevent the enemy from seeing them.

Scout positions must provide effective concealment. One technique is to position vehicles inside woodlines and erase vehicle track marks leading to the woods. When concealment is not available, however, vehicles must be camouflaged to blend into the natural surroundings. All shiny objects that could reflect light and attract attention must be covered.

Damage-limiting measures

Dispersion is one of the most effective ways to reduce the effects of enemy air attack. It is essential when a unit is occupying static positions such as an assembly area or is preparing to cross a water obstacle or a breached obstacle. When the platoon is on the move and air guards identify an enemy air attack, vehicles disperse quickly, move to concealed positions if possible, and stop (a stationary vehicle is more difficult to see than a moving vehicle).

Another damage-limiting measure is the use of natural or man-made cover to reduce the effects of enemy munitions. Folds in the earth, depressions, buildings, and sandbagged positions can provide this protection.

ACTIVE AIR DEFENSE

Although passive measures are the first line of defense against air attack, the scout platoon must be prepared to engage enemy aircraft. The decision to fight back against an air threat is based on the situation and the capabilities of organic weapon systems. (**NOTE:** All platoon members must understand that they can defend against a direct attack but cannot engage aircraft that are not attacking them unless the applicable weapons control status allows it.)

Scouts have several weapon systems (chain guns, machine guns, and small arms) that can be used against aircraft when they must fight back. Engaging aircraft with volume fire is the key to effective use of small arms and machine gun fires against an air attack. These fires must be coordinated to be effective. Delivered on the platoon leader's command, they are directed at an aim point in front of the target (see [Figure 6-15](#)); gunners do not attempt to track the target. Guidelines for selecting aim points are listed in [Figure 6-16](#). They are simple and logical; they must be learned and retained by everyone in the platoon.

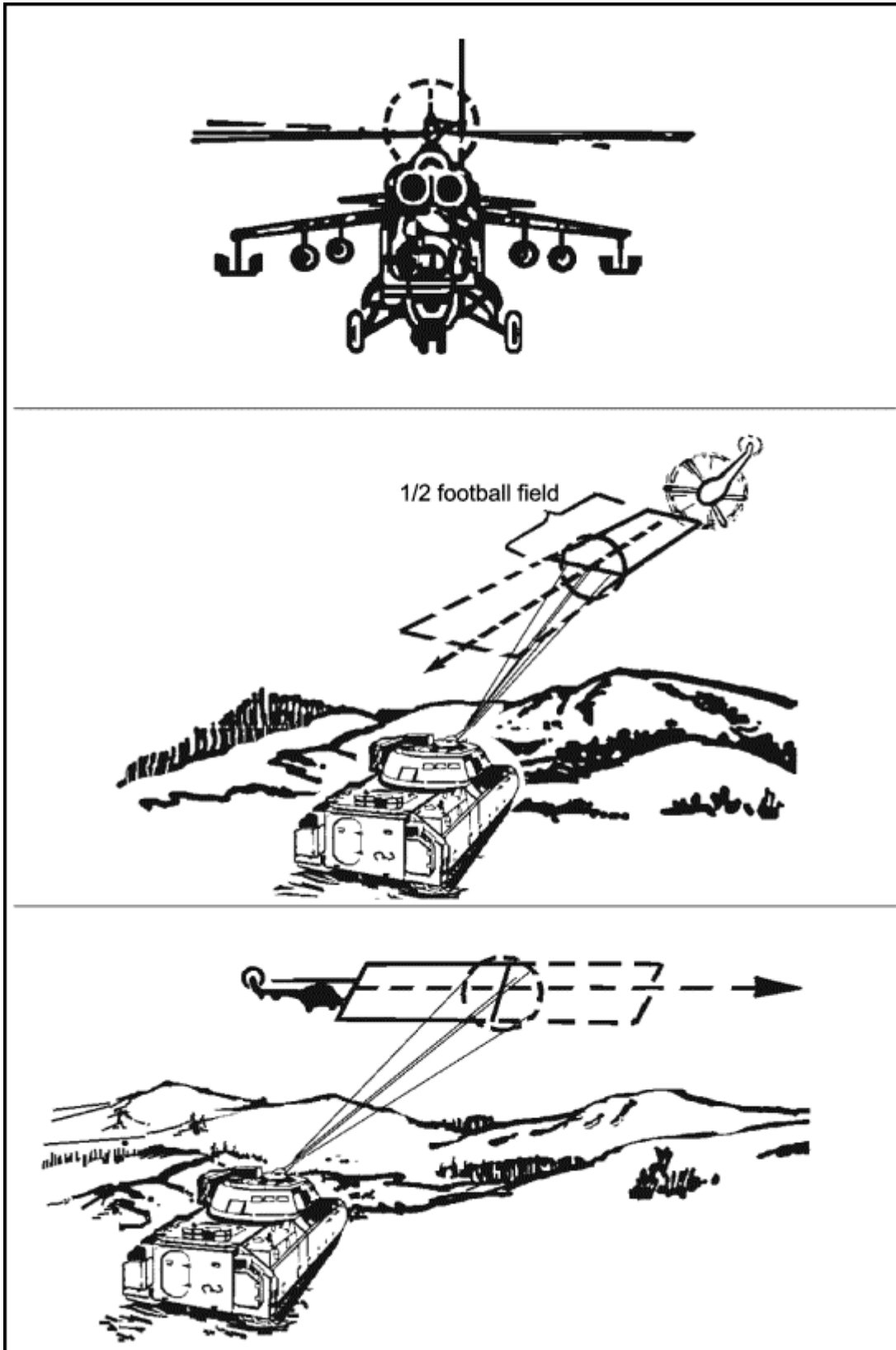

Figure 6-15. Aim points.

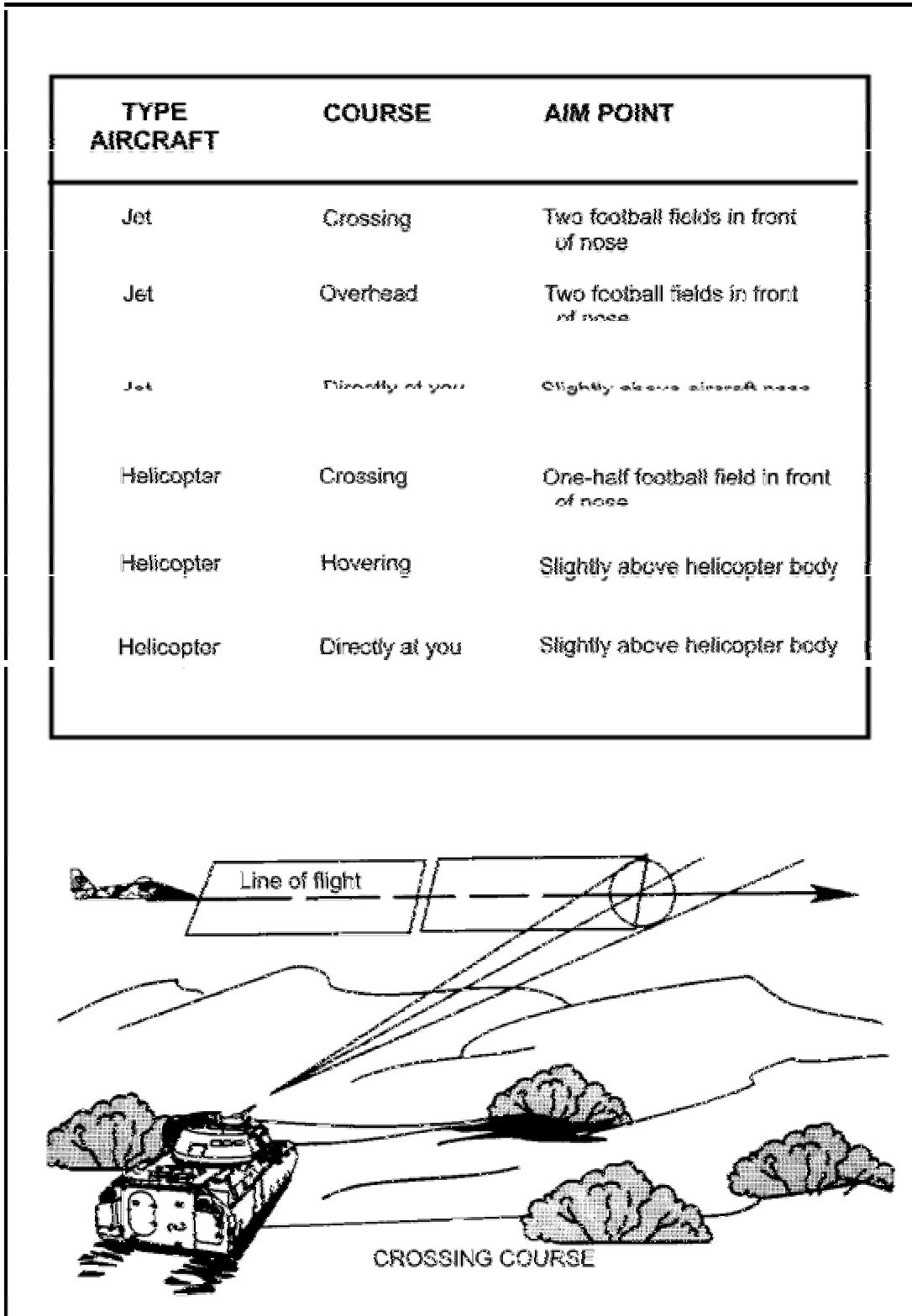

Figure 6-16. Guidelines for selecting aim points.

The Bradley's 25-mm gun is effective against slow-moving fixed-wing aircraft, helicopters, and UAVs. Vehicle commanders should instruct their gunners to fire 20- to 25-round bursts at a high rate to sustain the proper volume of fire when engaging these platforms. Accurate target identification is essential in determining the type of ammunition to employ.

SHORT-RANGE AIR DEFENSE SYSTEMS

Although other short-range air defense (SHORAD) systems support both divisional and regimental units, scout platoons with dedicated ADA systems are most likely to be supported by man-portable air defense systems (MANPADS). Figure 6-17 shows the Stinger MANPADS, which is designed to counter high-performance, low-level, ground attack aircraft; helicopters; and observation and transport aircraft.

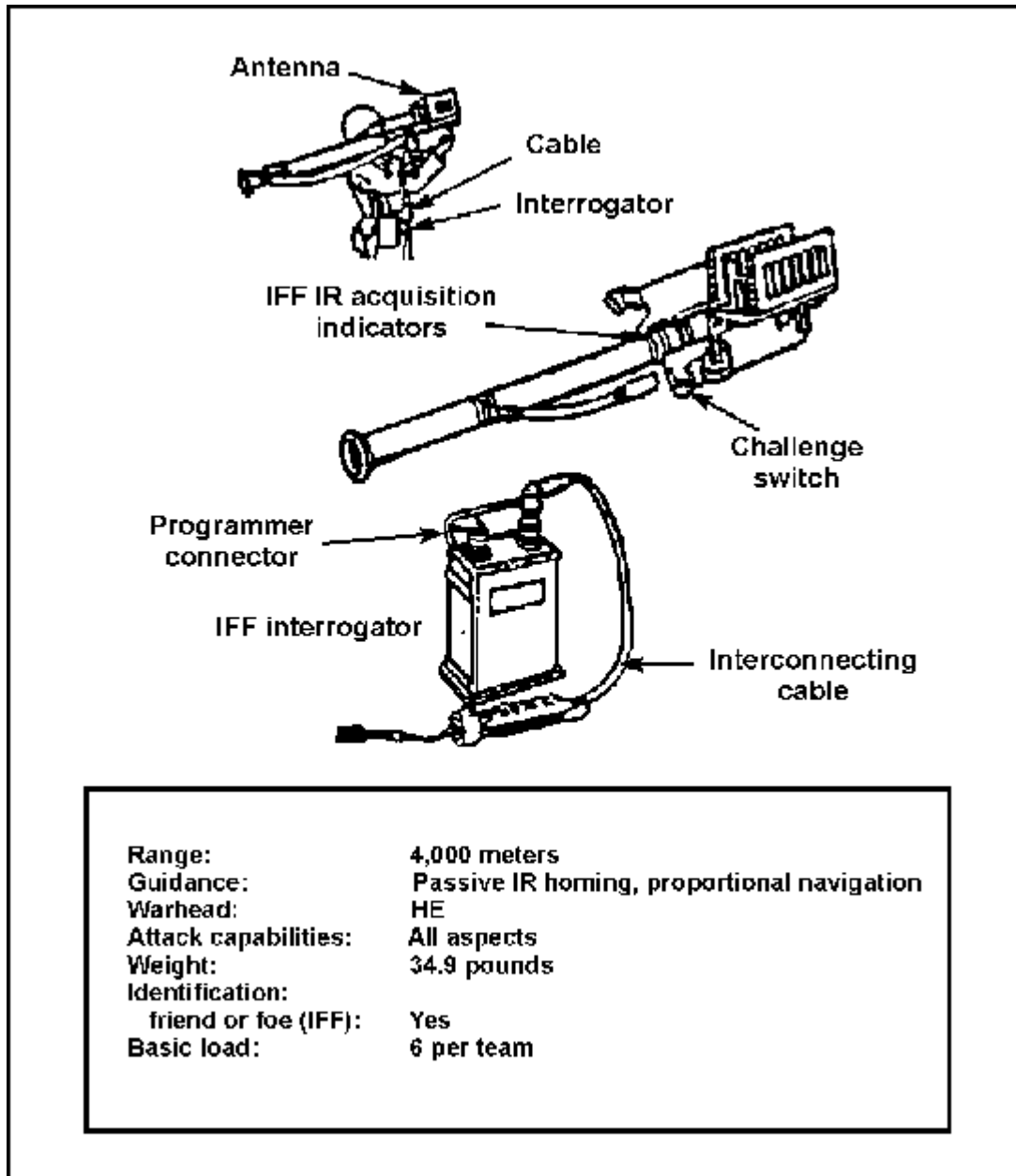

Figure 6-16. Guidelines for selecting aim points.

The Stinger missile system is employed by a two-man crew (crew chief and gunner). The MANPADS crew will normally have a wheeled vehicle (HMMWV), a Bradley Stinger fighting vehicle (BSFV), or an M6 Bradley Linebacker as its assigned transportation. Unit leaders must carefully consider the consequences before separating a Stinger team from its vehicle. Stinger teams operating away from their vehicles have no more than two missiles available for resupply. (**NOTE:** The M6 Linebacker has four ready-to-fire Stinger missiles; its crew does not have to dismount to fire.)

The scout platoon will receive early warning alerts from the SHORAD battery and its elements. The SHORAD C3I Sentinel radar can broadcast early warning of air tracks to SHORAD elements (battery, platoon, or section), to FA fire units, and to air defense LOs. The SHORAD battery will then provide voice early warning on the brigade command net; when METT-TC factors permit, the SHORAD platoon may provide voice early warning to maneuver battalions.

The C3I Sentinel provides 360-degree detection capability for various types of air tracks (rotary- and fixed-wing aircraft, UAVs, and cruise missiles) to a range of 40 kilometers. It is OPCON to the respective SHORAD battery commander. The Sentinel should be integrated into the R&S plan in accordance with the IPB.

SECTION 5 — AIR SUPPORT

CLOSE AIR SUPPORT

CAS is air action by fixed- or rotary-wing aircraft against hostile targets that are in close proximity to friendly ground forces. It is a powerful battlefield asset, capable of destroying enemy elements of varying sizes, including large armor formations. Each CAS mission requires detailed integration with the fire and movement of ground forces.

CAS strikes can be either preplanned (at battalion or squadron level) or requested on an immediate-need basis through the battalion forward air controller (FAC). The FAC on the ground or in the air acts as a link between the ground element and the CAS aircraft.

Army air cavalry is best equipped to coordinate with Air Force assets in joint air attack team (JAAT) and attack helicopter operations. The air cavalry can see the battlefield and the target better than ground forces can, and it has the radio equipment needed to talk to Air Force aircraft. The attack aircraft organic to air cavalry can assist CAS aircraft in suppressing the enemy ADA threat.

Although planning normally begins at battalion/squadron level, the scout platoon may be tasked to provide information for CAS employment. Scouts should familiarize themselves with the procedures used to call for CAS. If CAS assets are working for their battalion, the scouts should provide suppressive fires on any known or suspected enemy ADA locations.

MARKING FRIENDLY POSITIONS

Friendly positions should always be marked during close air strikes, especially when friendly troops are within 300 meters of the target. Resources for marking positions include the following:

- **Smoke.** The smoke grenade is the most commonly used marker, but it has limitations. Wind may cause smoke to drift above trees, and some colors can blend with the background. Violet or white smoke shows up well with most backgrounds.
- **Flares.** Rocket or 40-mm flares are good for attracting attention at night; they are sometimes effective during the day.
- **Mirrors.** Signal mirrors are probably the best ground-to-air devices for attracting attention. If the sun is shining and the operator is skillful, pilots can see a mirror flash miles away. VS-17 signal panels are also good visual references for pilots.
- **Lights.** Pocket-size, battery-powered strobe lights produce brilliant white or blue flashes at about 1 1/2-second intervals. The flash is visible at night for 1 to 3 miles. Vehicle lights, such as an unshielded red taillight, are visible to a pilot for several miles at night. Chemical glow lights can be used to mark friendly positions. Another technique that can be used at night is to tie an infrared (IR) or green chemical light on a 10-foot string. When aircraft are in the area, a scout can swing the rope in a circular motion to mark the location.
- **Glint tape.** This highly reflective tape can be cut to the appropriate size and attached to personnel and vehicles in accordance with an established SOP. The tape is visible through night vision devices at great distances.
- **Ground commander's pointer.** This hand-held "laser"-type pointer is used in many ground units. Although invisible to the naked eye, its beam is visible through night vision devices. This allows ground elements to clearly show the air element the locations of either friendly or enemy elements. Depending on the specific device, the pointer may or may not be eye-safe. Ground elements can also use AIM-1 or PAC-4 lasers.

SECTION 6 — GROUND SURVEILLANCE RADAR

GSR teams can enhance the surveillance capability of scout platoons by detecting targets and providing accurate range and azimuth readings to enemy locations during limited visibility conditions. A team consists of three soldiers, one AN/PPS-5 radar unit, and an armored personnel carrier (APC) or HMMWV.

For combat operations, GSR teams are usually attached to battalions and squadrons. The teams may be attached or OPCON to companies, troops, or scout platoons for specific missions. When GSR is attached or OPCON to the scout platoon, the platoon leader must plan its employment. He should work with the battalion S2 to position GSR assets in conjunction with scout OPs to provide local security and protection.

CAPABILITIES AND LIMITATIONS

GSR teams provide mobile, all-weather battlefield surveillance. When employed in pairs, they can provide observation from a given vantage point 24 hours a day.

GSR targets are classified as dismounted, light vehicle, heavy vehicle, or tracked vehicle. The AN/PPS-5 has a line-of-sight range of 10,000 meters against vehicles and 6,000 meters against personnel. It can detect targets through light camouflage, smoke, haze, light snow and rain, and darkness. Foliage and heavy rain and snow seriously restrict its radar detection capability.

GSR is designed to detect targets moving against a background. It is generally ineffective against an air target unless the aircraft is flying close to the ground. It is vulnerable to enemy direction-finding and jamming equipment. The GSR team is normally equipped with a single radio. If employed forward with the scouts, the team should send all reports to the scout platoon leader to be passed higher.

EMPLOYMENT

The GSR team should be assigned a specific sector of surveillance and frequency of coverage. Because the enemy can detect radar signals, however, GSR cannot be used for continuous surveillance. The tasks assigned to GSR teams in their surveillance mission may include the following:

- Searching avenues of approach or possible enemy positions on a scheduled or random basis to determine the location, size, and composition of enemy forces and the nature of their activity.
- Monitoring point targets such as bridges, defiles, or road junctions and reporting quantity, type, and direction of enemy vehicles and personnel moving through the target area.
- Extending the observation capabilities of the scouts by enabling them to survey distant points and areas of special interest.
- Vectoring patrols to keep them oriented during periods of limited visibility.

GSR must be positioned in an area that is free of ground clutter such as trees, thick vegetation, and buildings and that affords long-range observation and a wide field of view. Normally, the team will be assigned a general area, and the GSR team leader will select the specific position. To avoid enemy suppressive fires, the team should be prepared for rapid displacement and have several alternate positions selected and reconnoitered.

During reconnaissance operations, GSR is best employed to the flanks of the scout platoon or oriented on potential enemy locations. Since reconnaissance is a moving operation, the GSR teams will have to move as necessary to support the scouts.

In security operations, GSR teams can be used to provide redundancy in surveillance of NAIs and to add depth to the scout screen line by supplementing scout OPs.

CHAPTER 7

Combat Service Support

CSS elements arm, fuel, fix, feed, and provide transportation and personnel for the scout platoon. The platoon, however, has no organic CSS assets. This creates unique planning and operational challenges, with most of the responsibility falling to the PSG.

The PSG is the CSS coordinator for the platoon; in supervising CSS within the platoon, his role is similar to that of the 1SG in the company and troop. He is responsible for advising the platoon leader of the platoon's logistical requirements during preparation for combat operations as well as its current logistical status once operations are under way. The platoon's NCOs assist the PSG in executing resupply operations and in determining the platoon's logistical needs. In combat operations, the PSG coordinates directly with the 1SG, informing him of requirements and problems.

CONTENTS

<u>Section 1</u>	<u>Supply Operations</u>
<u>Section 2</u>	<u>Maintenance Operations</u>
<u>Section 3</u>	<u>Personnel Operations</u>
<u>Section 4</u>	<u>Medical Treatment and Evacuation</u>
<u>Section 5</u>	<u>Prisoners</u>

SECTION 1 — SUPPLY OPERATIONS

Scout platoons have a large amount of equipment and require frequent resupply to accomplish their mission. Periodic checks are required by all leaders to make sure the platoon's equipment, especially high-use items, is accounted for and ready to use. Leaders must anticipate expenditures and request supplies before an operation begins.

BATTALION TASK FORCE SUPPORT

The scout platoon presents complex logistical problems for the battalion task force staff. As explained in previous chapters, the platoon normally operates to the front of the task force. It will probably move earlier and stay away longer than any other battalion element. It can be resupplied in one of several ways.

One method entails the battalion dedicating a logistics package (LOGPAC) to the scout platoon. The LOGPAC responds to the needs of the platoon and is brought forward by the headquarters company

1SG, the support platoon leader, the headquarters company XO, or another responsible individual. The support package is small and flexible, tailored specifically to the scout platoon's requirements. (**NOTE:** The LOGPAC may include a maintenance team; refer to the discussion of maintenance operations in [Section 2](#) of this chapter.) The LOGPAC links up with the scout PSG at a specifically designated RP as far forward as possible. The PSG is then responsible for distribution of supplies to the scout sections and/or squads. He may distribute supplies by himself or be assisted by the individual who brought the LOGPAC forward. The latter method is significantly faster. This method is best for the scout platoon but is difficult for the battalion because of its own limited CSS resources.

The scout platoon can also use the nearest company team's CSS assets for its resupply and maintenance. If this technique is used, the HHC commander and scout platoon leader should coordinate with the company team commander for support. The HHC commander and battalion S4 should ensure that the supplies dedicated for the resupply of the scout platoon are forwarded with the company team's regular LOGPAC. If possible, scout supplies pushed forward with the company team LOGPAC should be separated to ensure rapid resupply of the scouts.

Another method is to make the scouts responsible for their own supplies. Not only must the PSG coordinate for supplies, but he also must pick up the LOGPAC, distribute the supplies, and return the LOGPAC to its parent-unit location. This stretches the platoon to its limit because it must operate without the PSG for extended periods of time. This method also does not provide dedicated CSS assets for the scout platoon. **It is the easiest method of resupply for the battalion but the worst for the scout platoon.**

Whatever support the scout platoon receives must be keyed to a fast transfer of supplies. The scouts must be able to pull in, resupply, and leave as quickly as possible. The actual time when the scouts need to resupply often does not coincide with the standard LOGPAC times for the rest of the battalion. The battalion S4, the support platoon leader, the scout platoon leader and PSG, and any other key leaders must anticipate events to coordinate for the best time of resupply.

SQUADRON SUPPORT

The scout platoon in a divisional or regimental squadron receives all of its CSS through its parent troop. The PSG coordinates with his 1SG for everything the platoon requires. The 1SG is thus the key operator in the service support chain. He does most of the coordination with the squadron combat trains command post (CTCP) and controls the LOGPAC and its operation. Based on the tactical situation, the 1SG will also choose the techniques of resupply.

BASIC AND COMBAT LOADS

Two sets of guidelines, for the basic load and the combat load, prescribe the quantities of supplies required by the scout platoon during tactical operations. (**NOTE:** A summary of the classes of supply follows this discussion.)

Basic load

The basic load is the quantity of supplies in Classes I, II, III, IV, V, and VIII that the scout platoon is required to have on hand to initiate combat operations. The basic load is designated by the platoon's

higher headquarters based on analysis of the platoon's mission and the anticipated threat.

Combat load

The combat load is the quantity of supplies, in all classes, that the scout platoon must have on hand to sustain operations in combat for a prescribed number of days. The platoon's parent unit must be capable of moving the combat load, using organic transportation assets, into combat in a single delivery. Like the basic load, the platoon's combat load is designated by higher headquarters.

CLASSES OF SUPPLY

Class I

This class includes subsistence items. MRE rations are stocked on each vehicle, usually a three- to five-day supply. Hot meals are brought forward when possible, if only to supplement MREs. Potable water should be replenished daily, either by refilling from the water trailer or by rotating 5-gallon cans with the 1SG or supply sergeant. Each combat vehicle should maintain a minimum of 30 gallons of potable water; it must have more water on hand during operations in arid climates or in MOPP gear.

All meals should be eaten in shifts, and they should never be served at one centralized location. The platoon leader and PSG must make sure not only that the platoon is fed, but also that the scouts eat nutritious meals to maintain the energy levels required in combat. During continuous or cold-weather operations, soldiers will eat more than three meals per day; the platoon leader and PSG must plan for this extra allowance.

Class II

This class includes field sanitation, cleaning, and administrative items, as well as organizational clothing and individual equipment (OCIE). Sanitation, cleaning, and administrative supplies are requested and received from the troop or company supply NCO and can be brought forward with the LOGPAC. OCIE items are replaced on an individual, as-needed basis.

Class III and Class V

Class III comprises all types of POL products. Class V covers all types of ammunition, including small arms, artillery and tank rounds, mines and demolitions, fuzes, missiles, and bombs. For optimum security, rearming and refueling should occur simultaneously under cover of darkness. This usually occurs daily or at the conclusion of major operations. The techniques of refueling and rearming are covered later in this section.

Cavalry units and battalions that have air assets OPCON to them have the flexibility to resupply by helicopter. This is done when distance or time would severely tax conventional resupply methods. Leaders should consider location and security of the resupply site, types of supplies to be delivered, signals, and assistance required by the delivering unit.

The platoon leader must control the redistribution of supplies when fuel and ammunition cannot be delivered or when only limited quantities of supplies are available. The PSG continuously monitors the platoon's supply status through logistical reports (see [FKSM 17-98-3](#)). He notifies the platoon leader when a specific vehicle or the platoon as a whole is critically short of these major classes of supply. The

PSG should make sure ammunition is equally distributed throughout the platoon before any tactical operation and during consolidation on an objective.

When planning for refueling, the platoon leader should keep the range and fuel capacity of his vehicles and the requirements of future operations in mind. The amount of fuel required determines how much time it will take to refuel. The platoon leader must realize that the cruising range and estimated fuel consumption of a vehicle are only approximations, subject to the effects of weather, terrain, and other factors. The platoon must top off vehicles whenever the tactical situation permits.

When time is limited, the platoon leader must choose between topping off vehicles that need the most fuel first or giving limited amounts to each vehicle. Every vehicle must maintain a stock of oil, grease, and hydraulic fluid, replenishing these POL products each time refueling takes place.

Class IV

This class includes construction and barrier materials. Barrier materials such as lumber, sandbags, concertina or barbed wire, and pickets are used by the platoon to construct OPs and obstacles and to improve fighting positions. These materials are requested through the troop headquarters or, in a battalion scout platoon, through the HHC or directly from the S4.

Class VI

This class covers personal demand items. Tobacco products, candy, and toiletry articles are normally sold through the exchange system during peacetime or for units not in a combat environment. In a combat environment, these items are sent with Class I as health and comfort packs.

Class VII

Class VII includes major end items. These major pieces of equipment, assembled and ready for intended use, include combat vehicles, missile launchers, artillery pieces, and major weapon systems. Major end items that are destroyed are reported immediately by means of logistical reports (see [FKSM 17-98-3](#)). They are replaced by the parent unit as they are reported.

Class VIII

This class includes medical supplies, which are provided through the battalion or squadron medical platoon. These supplies include individual medical supplies such as first-aid dressings, refills for first-aid kits, water purification tablets, and foot powder.

Class IX

This class comprises repair parts. Class IX supplies are requisitioned through the company or troop maintenance section.

TECHNIQUES OF RESUPPLY

The tactical situation and type of scout platoon will dictate which technique of resupply the platoon will use. The most common techniques are those involved in routine resupply using a LOGPAC: tailgate, service station, a variation of one type, or a combination of both types. The scout platoon may also receive supplies by other techniques, such pre-positioning or aerial resupply.

The situation will also dictate when resupply takes place. Medical support should be brought forward with the LOGPAC as needed. Generally, scouts attempt to avoid resupply during reconnaissance operations; rather, they should conduct resupply during mission transition. Resupply is unavoidable during security missions of long duration.

Routine resupply techniques

In the tailgate technique, fuel and ammunition are brought to the scout sections or squads by the PSG or another responsible individual who is assisting him (see [Figure 7-1](#)). This technique is used when routes leading to vehicle positions are available and the unit is not under direct enemy observation and fire. Tailgate resupply is time-consuming, but it is useful in security missions when the scouts are not moving because stealth is more easily maintained. If necessary, supplies can be hand-carried to vehicle positions to further minimize signatures.

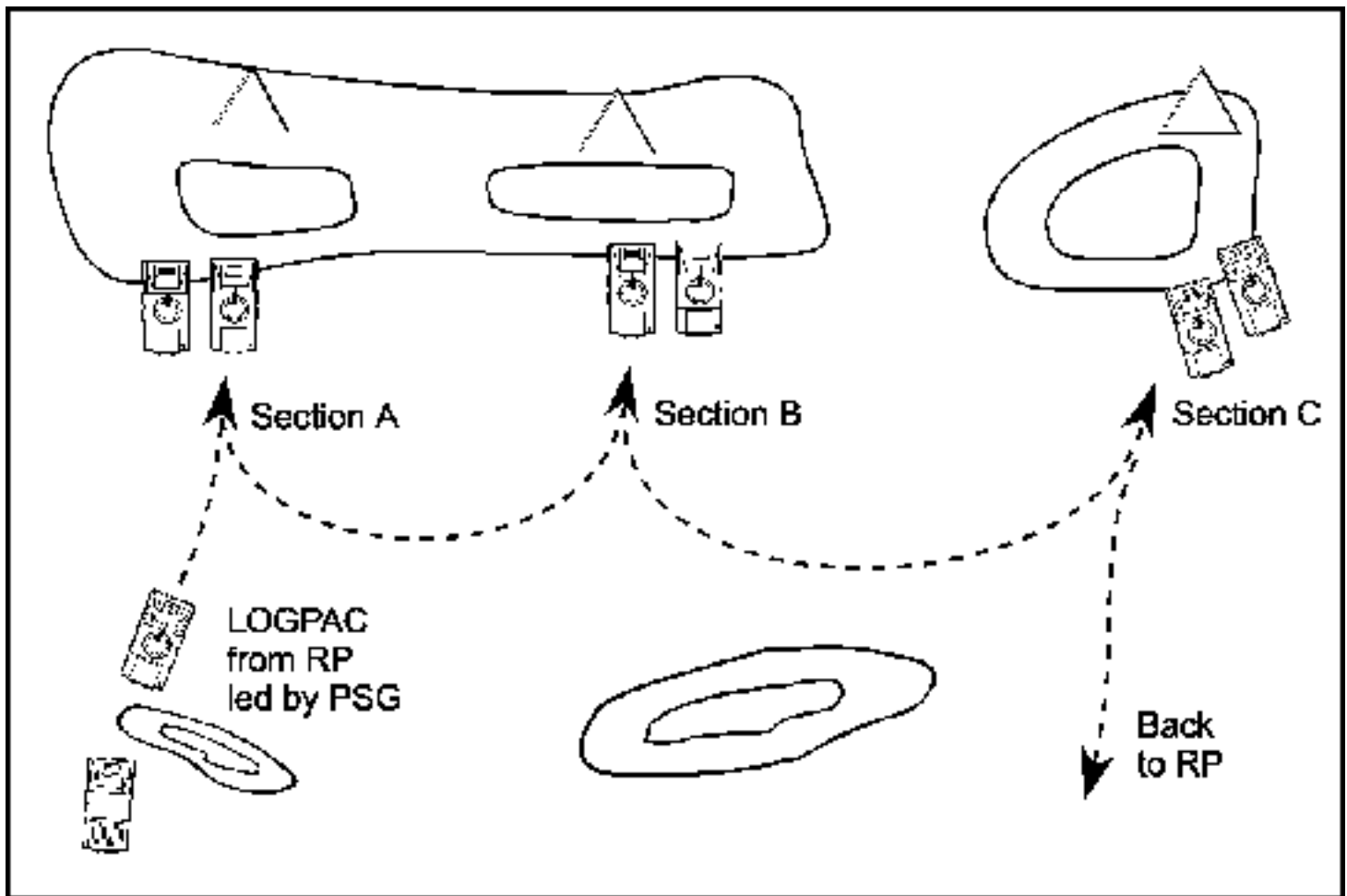

Figure 7-1. Tailgate resupply technique.

In the service station technique, vehicles move to a centrally located rear and refuel point, either by squad or section or as an entire platoon (refer to [Figure 7-2](#)). Service station resupply is inherently faster than the tailgate technique; because vehicles must move and concentrate, however, it can create security problems. During screening missions, the platoon must be careful not to compromise the location of OPs.

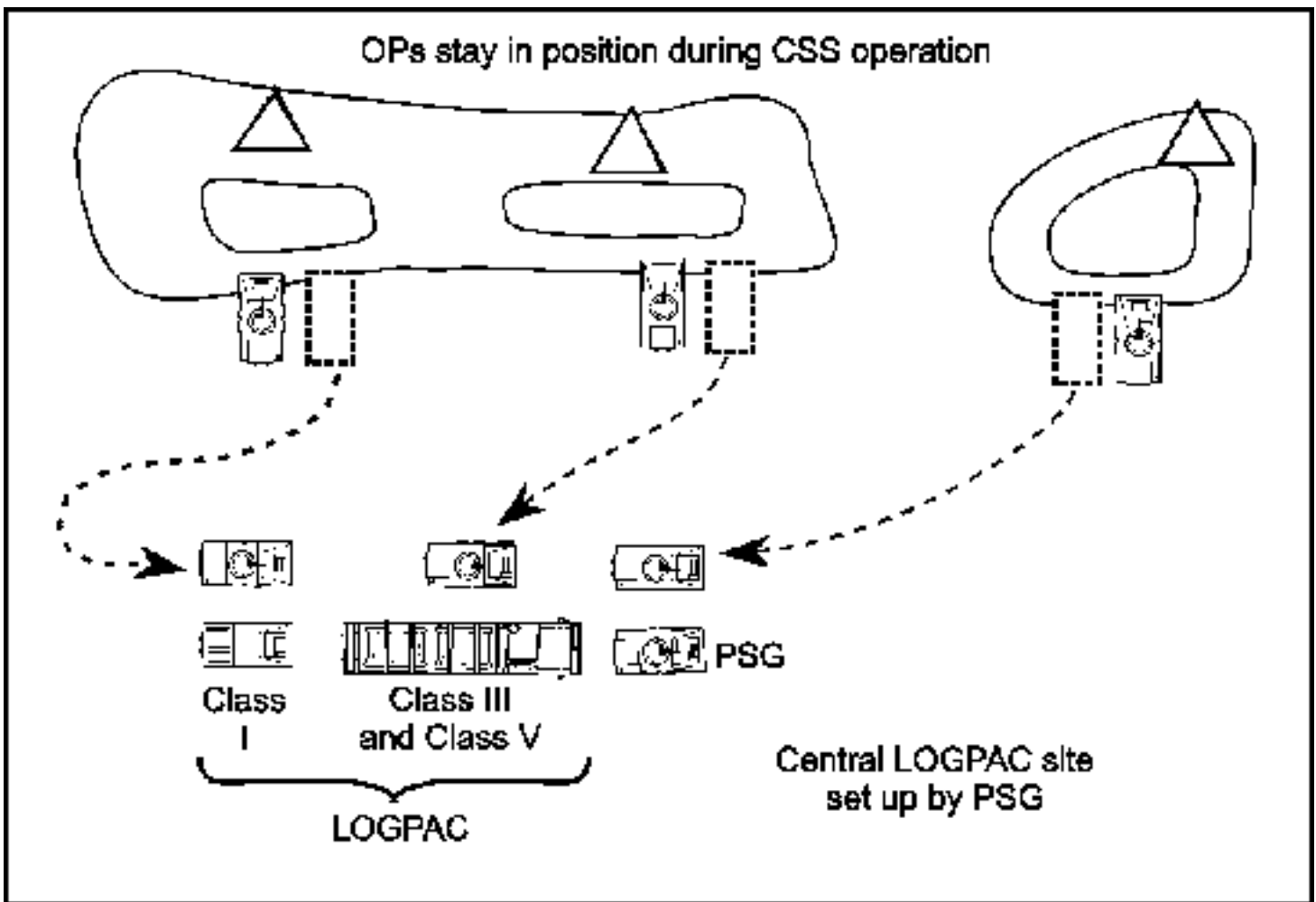

Figure 7-2. Service station resupply technique.

The platoon leader can vary the specifics of the two basic techniques, or he can use them in combination. During a screening mission, for example, he may use the tailgate method for his most forward OPs and the service station method for his OPs in depth (see [Figure 7-3](#)).

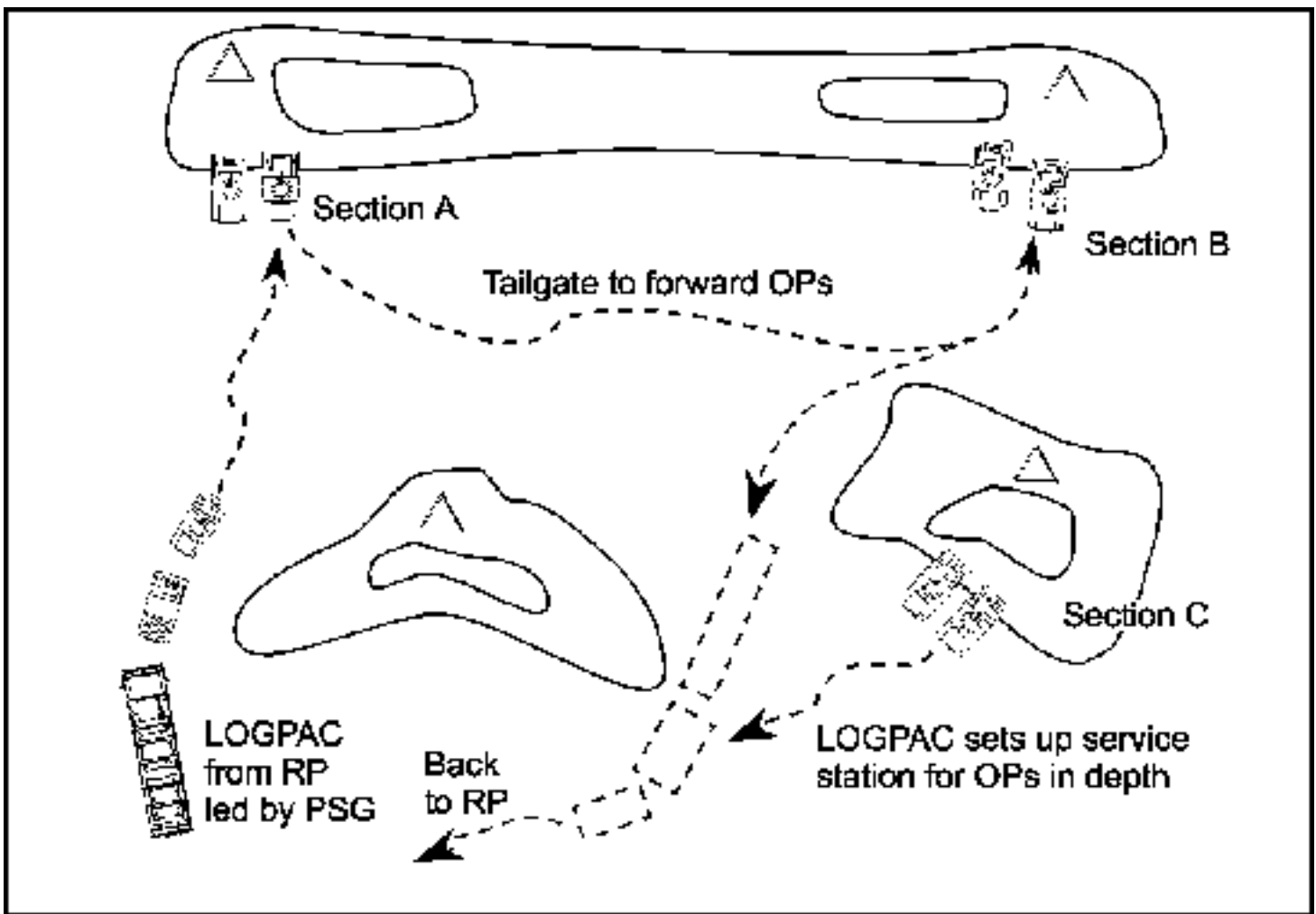

Figure 7-3. Combination of resupply techniques.

Other resupply techniques

Aerial resupply. Helicopters can be a vital lifeline when scouts are forced to operate forward of friendly lines for extended periods; they reduce the risks associated with conducting ground resupply operations under such conditions. Aerial assets are also useful in resupplying dismounted scouts in OPs in restricted terrain. On the other hand, aerial resupply sometimes will not be feasible because helicopters are not available. In addition, the signature of resupply helicopters can compromise scout positions. Careful choice of resupply routes and landing zones helps to minimize this risk.

Pre-positioning. This resupply technique, also called prestock resupply, can be used in a variety of scout platoon operations. During reconnaissance, prestock positions can be established along the intended route of advance or near the objective by advance elements. In security operations, the reconnaissance platoon can set up prestock points throughout the area of operations. These points should be in each alternate or supplementary OP, in addition to other locations throughout the depth of the sector. Scouts can also use pre-positioning to provide resupply for patrols.

Prestock operations must be carefully planned and executed at every level. Prestock points should be placed where they can be located by simple instructions that are clear to someone who has never visited the site. All leaders, down to vehicle commander and squad leader, must know the exact locations of prestock points. The platoon leader must take steps to ensure security and survivability of supplies by digging in prestock positions, selecting covered and concealed positions, and considering the effects of

weather and terrain. He must also have a plan to remove or destroy pre-positioned supplies to prevent the enemy from capturing them.

Medical resupply. Because the scout platoon does not have an attached medic or medical vehicle, it must depend on its parent unit for medical services, including resupply. The company team or troop HHC responsible for providing the platoon with resupply must ensure that medical support is brought forward with the LOGPAC.

SECTION 2 — MAINTENANCE OPERATIONS

Proper maintenance keeps equipment and materiel in serviceable condition. It includes PMCS, as well as the functions of inspecting, testing, servicing, repairing, requisitioning, recovering, and evacuating equipment and materiel whenever necessary.

Maintenance operations are divided into several distinct levels: unit (operator and organizational), intermediate (direct support and general support), and depot levels. The platoon leader is concerned primarily with unit maintenance and repair of equipment in intermediate (DS) maintenance.

Repair and recovery are accomplished as far forward as possible. When equipment cannot be repaired on site, it is moved to the rear (but only as far as necessary for repair) to the unit maintenance collection point (UMCP), which is established and operated by the battalion or squadron maintenance officer.

LEADER RESPONSIBILITIES

Platoon leader

The platoon leader has ultimate responsibility for the condition and performance of the platoon's equipment and material. In that role, his duties include the following:

- Ensuring that all platoon vehicles, weapon systems, and equipment such as night observation devices (NOD), mine detectors, NBC equipment, and communications equipment are combat-ready at all times within the platoon's maintenance capabilities. The platoon leader also ensures that equipment that cannot be repaired at platoon level is reported to the commander as soon as possible.
- Knowing the current status of equipment, to include document numbers, job order numbers, and the stage of maintenance of his vehicles. The platoon leader keeps his higher commander informed of the current maintenance status.
- Coordinating with the maintenance officer in planning, directing, and supervising unit maintenance for the platoon.
- Developing and supervising an ongoing maintenance training program.
- Ensuring that crews have the appropriate technical manuals and are trained and supervised to complete the required level of maintenance properly.
- Ensuring that unit-level PMCS are performed on all assigned equipment in accordance with the appropriate operator's manuals.
- Ensuring that drivers and assistant drivers are trained and licensed to operate platoon vehicles and equipment.

- Planning and rehearsing a maintenance evacuation plan for every mission.

Platoon sergeant

The PSG has primary responsibility for most of the platoon's maintenance activities. His duties include the following:

- Ensuring that [DA Form 5988-E](#) and [DA Form 2408-18](#) are filled out and updated in accordance with DA Pam 738-750.
- Directing and supervising unit maintenance of platoon equipment, vehicles, and weapon systems.
- Helping the platoon leader comply with his responsibilities and assuming these responsibilities in his absence.
- Coordinating with the maintenance representative or motor sergeant to arrange unit repairs or to request intermediate (DS) maintenance.
- Supervising and accounting for platoon personnel during maintenance periods.
- Ensuring that repair parts are used or stored on a timely basis as they are received.
- Collecting and consolidating reports of the platoon's maintenance status in the field and sending the appropriate reports to higher maintenance personnel.
- Ensuring that vehicles are always topped off with fuel in garrison and that they receive fuel in the field.
- Keeping the platoon leader informed of the platoon's maintenance and logistics status.

Vehicle commander

Vehicle commanders are the platoon's first-line maintenance supervisors. In large part, the platoon's maintenance status, and thus its combat readiness, depends on their commitment to proper maintenance procedures. The vehicle commander's duties in this area include the following:

- Ensuring that [DA Form 5988-E](#) and [DA Form 2408-18](#) are filled out and updated in accordance with DA Pam 738-750.
- Ensuring that the crew is properly trained in PMCS procedures and that PMCS are performed on the vehicle and all assigned equipment in accordance with the appropriate technical manuals.
- Ensuring that, as a minimum, the assigned vehicle driver or equipment operator is properly trained and licensed. In preparing for continuous operations, vehicle commanders must ensure that all crewmembers are trained and licensed as drivers.
- Ensuring that repair parts are installed upon receipt or are stored in authorized locations.
- Ensuring that all tools and basic issue items are properly marked, stored, maintained, and accounted for.
- Ensuring that the vehicle is always topped off in garrison and that it receives as much fuel as possible at every opportunity in the field.
- Constantly updating the PSG on the maintenance and logistics status of the vehicle.

UNIT MAINTENANCE (OPERATOR LEVEL)

Operator maintenance includes proper care, use, and maintenance of assigned vehicles and crew equipment such as weapons, NBC equipment, and night vision devices. The driver and other crewmembers perform daily services on the vehicle and equipment, to include inspecting, servicing, tightening, performing minor lubrication, cleaning, preserving, and adjusting. The driver and gunner are required to use [DA Form 5988-E](#) to record these checks and services, as well as all equipment faults that they cannot immediately correct. The driver's and gunner's reports are the primary means of reporting equipment faults through the vehicle commander to the PSG, platoon leader, and ultimately to organizational maintenance personnel.

Checks and services prescribed for the automotive system, weapon systems, and turret (CFV only) are divided into three groups:

- Before-operation checks and services.
- During-operation checks and services.
- After-operation checks and services.

These services are explained in every operator's manual and should be conducted as stated in the manual. Although operators must learn to operate equipment without referring to the manual, maintenance must always be performed using the appropriate technical manual.

UNIT MAINTENANCE (ORGANIZATIONAL LEVEL)

Organizational maintenance is the responsibility of the unit assigned the equipment. It is performed by the operators and unit mechanics. Because the CFV's design allows rapid modular replacement of parts, many faults can be corrected, and the vehicle returned to the platoon, rapidly.

When the operator identifies a problem that is beyond his level of maintenance capability, he notifies his chain of command so the problem can be isolated and corrected. The company or troop maintenance team has trained mechanics who are authorized to perform unit maintenance tasks as prescribed in the technical manuals for the vehicle. When company, troop, battalion, or squadron maintenance teams are not authorized to make a particular repair, they will arrange to have it done by DS maintenance assets.

INTERMEDIATE (DIRECT SUPPORT) MAINTENANCE

This level is performed by personnel from the intermediate (DS) maintenance company, which normally supports a brigade or regiment. It consists of repair and/or replacement of parts, assemblies, and components. Maintenance support teams from intermediate (DS) units are usually located forward with the squadron or battalion field trains. These support teams may go forward to fix disabled equipment on site, but they are limited in what they can fix and where they can go.

EVACUATION

Evacuation is necessary when a vehicle is damaged and cannot be repaired on site within two hours or when it is the only means available to prevent capture or destruction by the enemy. (**NOTE:** Repair times are dependent on METT-TC; the two-hour limit is only a guideline for planning purposes.) With the

exception of an entire vehicle, most damaged equipment can be transported by the platoon until it can be picked up by the troop or battalion support elements. It is then evacuated by troop or battalion maintenance personnel or by the DS maintenance unit.

When a vehicle must be evacuated, the platoon leader or PSG reports the exact location, vehicle type, and extent of damage, if known, on the troop net or battalion A/L net to personnel designated in the unit SOP. Two soldiers should remain with the vehicle to assist in evacuation and repair, provide security, and deliver the repaired vehicle back to the platoon as soon as possible. A recovery vehicle from the troop, company, squadron, or battalion maintenance team will evacuate the damaged vehicle. It is vital that the damaged vehicle be placed in a covered position that allows the recovery vehicle to reach it without exposing the recovery crew to enemy fire.

In the battalion task force, an evacuation vehicle should be dedicated to support the scouts. This vehicle should be positioned as far forward as possible; in many cases, it can be located with the nearest company team combat trains.

If a recovery vehicle is not available or if time is critical, other platoon vehicles can evacuate the damaged vehicle for short distances. The decision to do this rests with the platoon leader. Procedures for towing are contained in the operator's manual. If the damaged vehicle will be lost for an extended period, the platoon can replace other vehicles' damaged equipment (such as weapons and radios) with properly functioning items from the damaged vehicle. The damaged equipment can then be repaired or replaced while the vehicle is being repaired. Self-evacuation by the platoon is a last resort that should be considered only to avoid losing the damaged vehicle to the enemy.

DESTRUCTION

When evacuation of damaged or inoperable equipment is impossible, it must be destroyed. The platoon leader must get the commander's permission before destroying any equipment. Every reasonable effort must be made to evacuate secure equipment, classified materials, and all weapons.

SECTION 3 — PERSONNEL OPERATIONS

SERVICES

Personnel services include awards and decorations, leaves and passes, command information, mail, religious services, financial services, legal assistance, welfare, rest and relaxation, and any other service designed to maintain the health, welfare, and morale of the soldier. Many of these services are provided automatically by higher-level support elements; nonetheless, the platoon leader is ultimately responsible for arranging for and providing them to his platoon.

MANAGEMENT

Personnel management includes classification, assignment, promotions, and reenlistment. Although the platoon leader requests these actions through the company or troop, they are normally performed by the battalion or squadron staff or by a division-level organization. The platoon leader must submit accurate strength reports to make sure critical personnel shortages, such as vehicle commanders and gunners, are

filled with qualified personnel.

SECTION 4 — MEDICAL TREATMENT AND EVALUATION

HEALTH AND HYGIENE

The platoon leader and PSG must emphasize and enforce high standards of health and hygiene at all times. This "preventive maintenance" approach should cover all aspects of the soldier's health and well-being, including the following:

- Daily shaving to ensure proper fit of the protective mask.
- Regular bathing and changing of clothes.
- Prevention of weather-related problems. These include cold-weather injuries such as frostbite, trench foot, and immersion foot and heat-related injuries like heat exhaustion and heat stroke. Soldiers must understand the effects of such conditions as sunburn and windchill.
- Battle fatigue prevention, including strict implementation of the unit sleep plan.

WOUNDED SOLDIERS

Battlefield positioning and dispersion make treatment and evacuation of wounded personnel two of the most difficult tasks the scout platoon must execute. This is particularly true for the battalion scout platoon. To ensure successful handling of wounded scouts, the battalion must specifically allocate CSS assets to the scout platoon to assist in evacuation. In addition, operational planning or SOPs must cover evacuation procedures in detail.

In both types of scout platoon, the combat lifesaver and/or the vehicle commander are almost always the first ones on the scene to begin the process of treating personnel who are wounded in action (WIA). With the help of the vehicle commander, the combat lifesaver provides initial first aid to wounded or injured soldiers. He prepares them for medical evacuation or returns them to duty status after rendering first aid. Whenever possible, there should be at least one combat lifesaver on each platoon vehicle at all times. Vehicle commanders and their crews must be prepared to give immediate first aid as necessary and to continue the mission, without stopping, with a limited crew.

The vehicle commander is responsible for ensuring that the PSG is informed of casualties. He coordinates with the PSG for ground evacuation or for aerial evacuation. If wounded crewmen require evacuation, the platoon leader or PSG can take one of these steps:

- Coordinate for aerial evacuation through the troop or battalion.
- Conduct self-evacuation with organic platoon assets.
- Request that the battalion or troop task organize a dedicated ambulance to the platoon for operations forward of the larger element. In the case of the HMMWV platoon, the ambulance should be a HMMWV variant located, for security, with the nearest company team.
- Coordinate with the closest troop or company team for ground evacuation.

The vehicle commander ensures that casualty feeder and witness statement forms are completed (the casualty feeder card stays with the wounded soldier; witness statements are given to the PSG). The PSG

ensures that the witness statements are turned over to the 1SG.

Aerial evacuation, if it is available, is preferred because of its speed. The scouts coordinate with their higher command and then switch to the designated frequency to coordinate directly with the MEDEVAC or CASEVAC aircraft. They must pick a relatively flat, open, and covered and concealed position for the aircraft's landing zone (LZ). The location should be given to the aircraft by radio and marked with colored smoke as the aircraft approaches the area. The scout platoon provides local security of the LZ until the evacuation is complete.

Regardless of the method of evacuation, all scout leaders must have the necessary CSS graphics available, including locations of battalion or troop casualty collection points. Evacuation procedures must be part of the platoon plan and should be rehearsed as part of mission preparation.

A wounded crewman's individual weapon becomes the responsibility of the vehicle commander. Personal effects, weapons, and equipment are turned in to the company or troop supply sergeant at the earliest opportunity. The crewman's protective mask stays with him at all times. All sensitive items such as maps, overlays, and SOPs should also remain with the vehicle.

SOLDIERS KILLED IN ACTION

The battalion or squadron S4 designates the location of the collection point for soldiers who are killed in action (KIA). The scout platoon leader selects the location of a platoon KIA collection point and report its eight-digit grid to the battalion or squadron/troop. This collection point will be used only as a last resort when KIA soldiers must be left on the battlefield. The name of each dead soldier, the exact location of the body, and the circumstances are reported to higher headquarters as soon as possible within the limits of the mission.

The platoon leader designates a primary and alternate vehicle to extract KIAs from the battlefield to the next scheduled LOGPAC location. The remains of these personnel are placed in a body bag or sleeping bag or rolled in a poncho for evacuation. The lower dog tag is removed for turn-in to the PSG; he forwards it to the 1SG during the next resupply operation along with witness statements from those who witnessed the action. The personal effects of the KIA soldier remain with the body. The soldier's weapon, equipment, and issue items become the responsibility of the vehicle commander until they can be turned over to the supply sergeant or 1SG by the PSG.

As a rule, every effort must be made not to place the bodies of KIA soldiers on the same vehicle as wounded soldiers. If the platoon leader or 1SG cannot expedite evacuation, however, KIAs and WIAs may be carried together on a vehicle until it reaches its next stop. In the attack, this destination may be the objective. In the defense, it may be the next BP.

SECTION 5 — PRISONERS

EPWs are excellent sources of combat intelligence; they must be processed and evacuated to the rear quickly. If enemy soldiers want to surrender, it is the crew's responsibility to take them into custody and control them until they can be evacuated.

The platoon leader will designate a primary and alternate vehicle responsible for the handling of EPWs

as well as the transportation of the EPWs to the collection point designated in paragraph 4 of the battalion or troop OPORD. The prisoners are then evacuated to the rear for interrogation.

HANDLING PRISONERS OF WAR

The basic principles for handling EPWs are covered by the "five-S" procedures: search, segregate, silence, speed, and safeguard. See [Figure 7-4](#) for a summary of these procedures. In addition to these steps, the scout platoon leader must ensure that prisoners are tagged with all necessary information prior to transporting them to the rear; refer to the discussion later in this section.

SEARCH	Remove and tag all weapons and documents. Return to the EPW those personal items of no military value. The EPW keeps his helmet, protective mask, and gear to protect him from immediate dangers of the battle area.
SEGREGATE	Break the chain of command; separate EPWs by rank, sex, and other suitable categories. Keep the staunch fighters away from those who willingly surrender.
SILENCE	Prevent EPWs from giving orders, planning escapes, or developing false "cover stories."
SPEED	Speed EPWs to the rear to remove them from the battle area and to obtain and use their information.
SAFEGUARD	Prevent EPWs from escaping. Protect all EPWs from violence, insults, curiosity, and reprisals of any kind.

Figure 7-4. The "five-S" principles for handling EPWs.

The senior officer or NCO on the scene is legally responsible for the care of EPWs. If the unit cannot evacuate a prisoner within a reasonable time, he must be provided with food, water, and medical treatment.

The rights of EPWs have been established by international law, and the United States has agreed to obey these laws. Once an enemy soldier shows he wants to surrender, he must be treated humanely. It is a court-martial offense to physically or mentally harm or mistreat an EPW or needlessly expose him to fire. In addition, mistreated EPWs or those who receive special favors are not good interrogation subjects.

Scouts should never make the initial approach to an enemy soldier. He may have a weapon hidden nearby, or he may be booby-trapped. To be safe, the scouts should gesture for him to come forward until it is clear that he is honestly surrendering and not trying to lure friendly troops into an ambush. They can

use a thermal sight to locate possible ambushes. The scout who searches the prisoner should always have another friendly soldier cover him with a weapon. The searcher must not get between the enemy and the soldier covering him.

If an EPW is wounded and cannot be evacuated through medical channels, a combat lifesaver will treat the wounds and attempt to stabilize the prisoner. The supporting company or troop XO or 1SG will be notified of the prisoner's status, and evacuation will be coordinated using other means.

Before evacuating the EPW, the platoon leader must ensure that a tag is attached to him listing all pertinent information and procedures. A copy of this tag is forwarded to higher headquarters. Tags may be obtained through supply channels or made from materials available on the battlefield. The tag should contain the following information:

- Date of capture.
- Name of prisoner.
- Prisoner's rank.
- Prisoner's serial number.
- Prisoner's date of birth.
- Prisoner's unit.
- Location of capture.
- Capturing unit.
- Special circumstances of capture.
- List of weapons or documents in the prisoner's possession at the time of capture.

CAPTURED ENEMY DOCUMENTS AND EQUIPMENT

Captured enemy documents (such as maps, orders, records, and photographs) and equipment are excellent sources of intelligence. If captured items are not handled properly, however, the information in them may be lost or delayed until it is useless. These items must be evacuated to the next level of command as rapidly as possible.

The platoon should tag each captured item. If the item is found in the EPW's possession, include the prisoner's name on the tag and give the item to the guard. The guard delivers the item with the EPW to the next higher headquarters. The captured items should be tagged with the following information:

- Type of item (such as document or piece of equipment).
- Date and time of capture.
- Location of capture.
- Capturing unit.
- Special circumstances of capture, including the names of EPWs in possession of the captured items.

CIVILIANS

Civilians who are captured as the result of curfew violations or suspicious actions are treated the same as EPWs. The platoon evacuates them quickly to higher headquarters using the "five-S" principles discussed earlier in this section. They should be tagged in the same manner as prisoners.

CHAPTER 8

Basic Scout Skills

Scouts must be expert in a number of basic skills that individually or collectively are critical during all reconnaissance and security missions. This chapter covers many of these, including dismounted operations, patrolling, vehicle positioning, movement fundamentals, and actions on contact. A thorough understanding of these vital skills and principles is important both in the scout platoon leader's mission planning process and in mission execution by the platoon and its scout sections and squads.

CONTENTS

<u>Section 1</u>	<u>Dismounted Operations</u>
<u>Section 2</u>	<u>Surveillance Methods</u>
<u>Section 3</u>	<u>Vehicle Positions</u>
<u>Section 4</u>	<u>Formations</u>
<u>Section 5</u>	<u>Movement Techniques</u>
<u>Section 6</u>	<u>Fundamentals of Movement</u>
<u>Section 7</u>	<u>Danger Areas</u>
<u>Section 8</u>	<u>Actions on Contact</u>
<u>Section 9</u>	<u>Call for Fire</u>

SECTION 1 — DISMOUNTED OPERATIONS

Dismounted operations are appropriate, in some form, to virtually all scout missions. They are often the key to success in scout operations. The best scouting is done dismounted. It is essential that all scout leaders understand when and how to employ dismounted scouts to enhance their element's ability to conduct reconnaissance and security tasks. There are three major types of dismounted operations: local security tasks, OPs, and patrols. These missions are covered in this section and in [Sections 2](#) and [3](#) of this chapter.

The first step in many dismounted operations, a fast and efficient exit of the vehicle, is critical to effective tactical movement. Dismount drills allow scouts to move quickly and effectively both during the dismount and after it is completed. Although dismounting may occur under an almost unlimited number of unique conditions, drills can be developed for most situations that the platoon or its elements may encounter. These should include dismounting to establish local security, to establish a hasty OP, to

conduct a hasty reconnaissance patrol, and to reconnoiter a danger area.

Once the platoon has determined what its high-frequency hasty dismount tasks are, it can develop an SOP, similar to the one illustrated in [Figure 8-1](#), that specifically allocates individual tasks and equipment. As a minimum, standard dismount procedures will indicate what the mission is, who dismounts, and what equipment is dismounted based on the situation.

DISMOUNTING FOR HASTY RECONNAISSANCE		
Crew Position	Equipment	Actions
Section leader	Standard, map, and SOI	Orders hasty dismount. Briefs gunner/squad leader. Dismounts with equipment. Moves forward and does reconnaissance.
Gunner 1	Standard	Moves to commander's position. Assumes command of vehicle. Overwatches dismount element.
Driver 1	Standard	Maintains appropriate level of vehicle readiness (idle or engine off). Observes his assigned sector.
Dismount 1A	Standard and radio	Dismounts vehicle. Performs patrol duties.
Dismount 1B	Standard	Dismounts vehicle. Performs patrol duties.
Squad leader	Standard	Receives briefing from section leader. Assumes duties as mounted section leader. Overwatches dismount element as appropriate.
Gunner 2	Standard	Dismounts vehicle. Assumes duties as assistant dismount team leader.
Driver 2	Standard	Maintains appropriate level of vehicle readiness (idle or engine off). Observes his assigned sector.
Dismount 2A	Standard and radio	Dismounts vehicle. Performs patrol duties.
Dismount 2B	Standard	Dismounts vehicle. Performs patrol duties.

Figure 8-1. Sample SOP for dismounted operations.

The most common dismounted task performed by any scout element is local security. The primary purpose is to prevent close-in surprise of a mounted section or squad when it is halted for any period of time. Local security is also employed in a variety of other situations, such as during forward reconnaissance or as part of an OP.

A scout section, squad, or individual vehicle that halts for any amount of time should deploy dismounted soldiers to provide local security. These soldiers should never move out of visual range. The primary means of communications between the element and its local security should be hand-and-arm signals, with vocal signals and FM as primary backups. Wire communications can also be used; however, wire is usually not necessary or practical because of the proximity of an element to its local security. Wire is also time-consuming to establish.

When executing a reconnaissance mission, the lead squad in a section will frequently deploy local security to provide 360-degree observation and early warning. Typically, this involves one or, preferably, two dismounted soldiers, who move forward of the vehicle to investigate a danger area such as a clearing or dead space beyond a rise. The security personnel remain within the overwatch range of the mounted element and communicate via hand-and-arm signals. If they discover possible enemy presence, they signal the mounted element, which takes appropriate actions on contact. If all is clear, they signal the mounted element to move forward, then remount.

This type of local security task is fundamental to a properly executed reconnaissance mission; however, it can be very disruptive to the pace and tempo of the operation. The scout platoon can minimize the disruption, and maximize speed, by executing a dismount drill.

SECTION 2 — SURVEILLANCE METHODS

Surveillance is the systematic observation of a specific area. Scouts watch, listen, and employ electronic devices to observe their area of responsibility. The scout platoon can employ the techniques covered in the following discussion (OPs, patrols, and remote electronic and mechanical devices) to conduct surveillance of an assigned area.

OBSERVATION POSTS

The OP, the primary means of maintaining surveillance of an assigned avenue or NAI, is a position from which scouts observe the enemy and direct and adjust indirect fires against him. From the OP, scouts send SALUTE reports to their commander when observing enemy activity.

A scout platoon can occupy up to six short-duration OPs, one per squad, for up to 12 hours if the squads

are at full strength. For extended periods of time, the scout platoon occupies long-duration OPs by sections, which limits OPs to a maximum of three. In addition, the platoon can array OPs either in linear positions or in depth. Depth is the preferred method for maintaining contact with a moving enemy. Linear placement is effective when the enemy is not moving; it provides maximum eyes on the enemy.

Types of OPs

OPs can be executed either mounted or dismounted, as outlined in the following discussion.

Dismounted OPs. The dismounted OP provides maximum stealth and thus has the greatest likelihood of remaining undetected by the enemy. The disadvantages of the dismounted OP are the time it takes to remount and move if necessary and, if a ground-mounted thermal device is not available, the lack of optics capability. If rapid movement or displacement is anticipated, the OP should mount or remain mounted.

Mounted OPs. These offer the advantages of rapid movement and vehicle optics and protection. Because the enemy can more easily detect them, however, they are potentially much less effective than dismounted OPs.

Positioning of OPs

OPs may be placed on the battlefield either in a linear configuration or in depth. Linear placement (illustrated in [Figure 8-2](#)) allows the platoon to observe the assigned sector from several OP sites, reducing the chance of the enemy entering the sector without being observed. This method works well when the platoon has been assigned a large sector with few avenues of approach or is in desert-type terrain. In-depth OP placement (illustrated in [Figure 8-3](#)) allows the platoon to observe the entire sector by placing OP sites where the platoon can observe the most likely avenues of approach in the sector as well as along the sector flanks. This method works well when the platoon is assigned a sector with several avenues of approach or is in heavily wooded terrain. In-depth placement allows for redundancy in observation and better coverage of the sector.

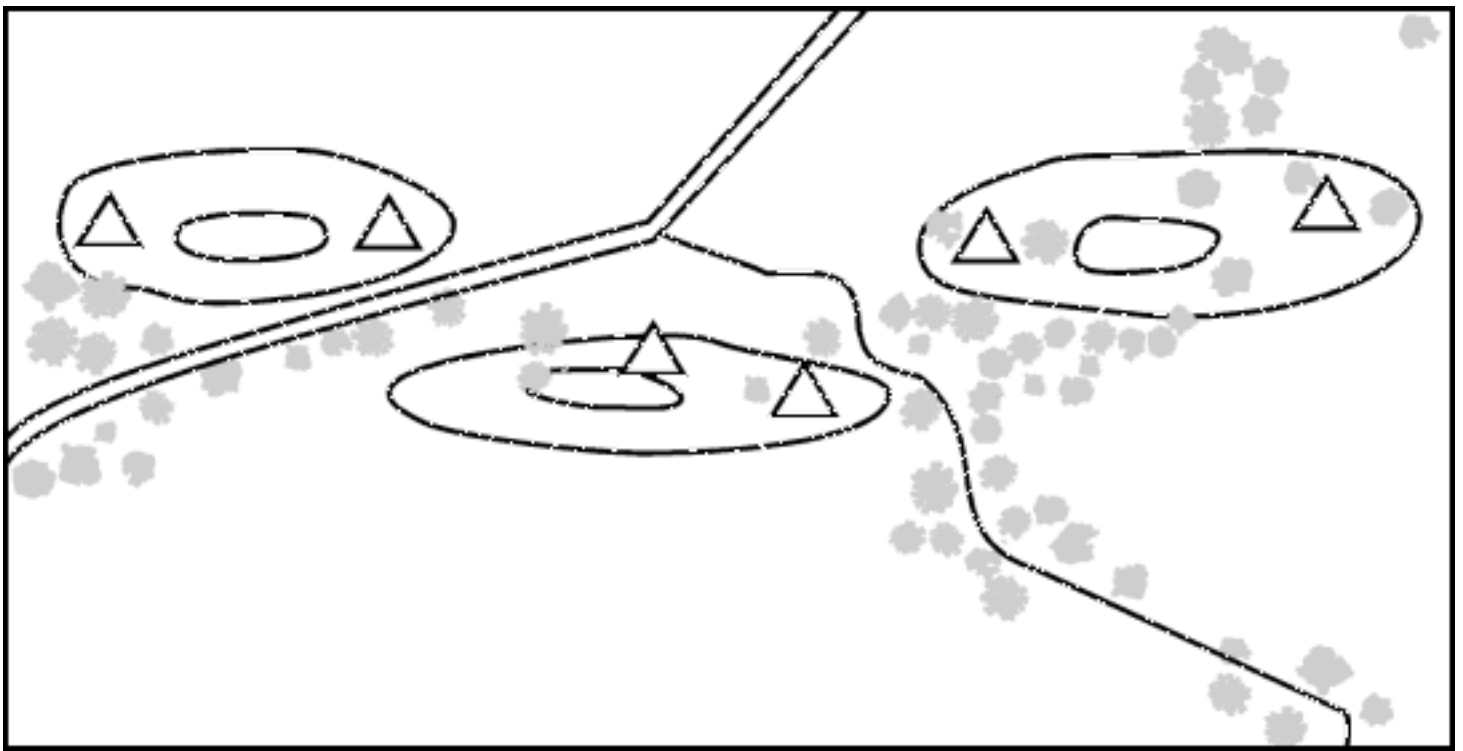

Figure 8-2. Figure 8-2. Linear positioning of OPs.

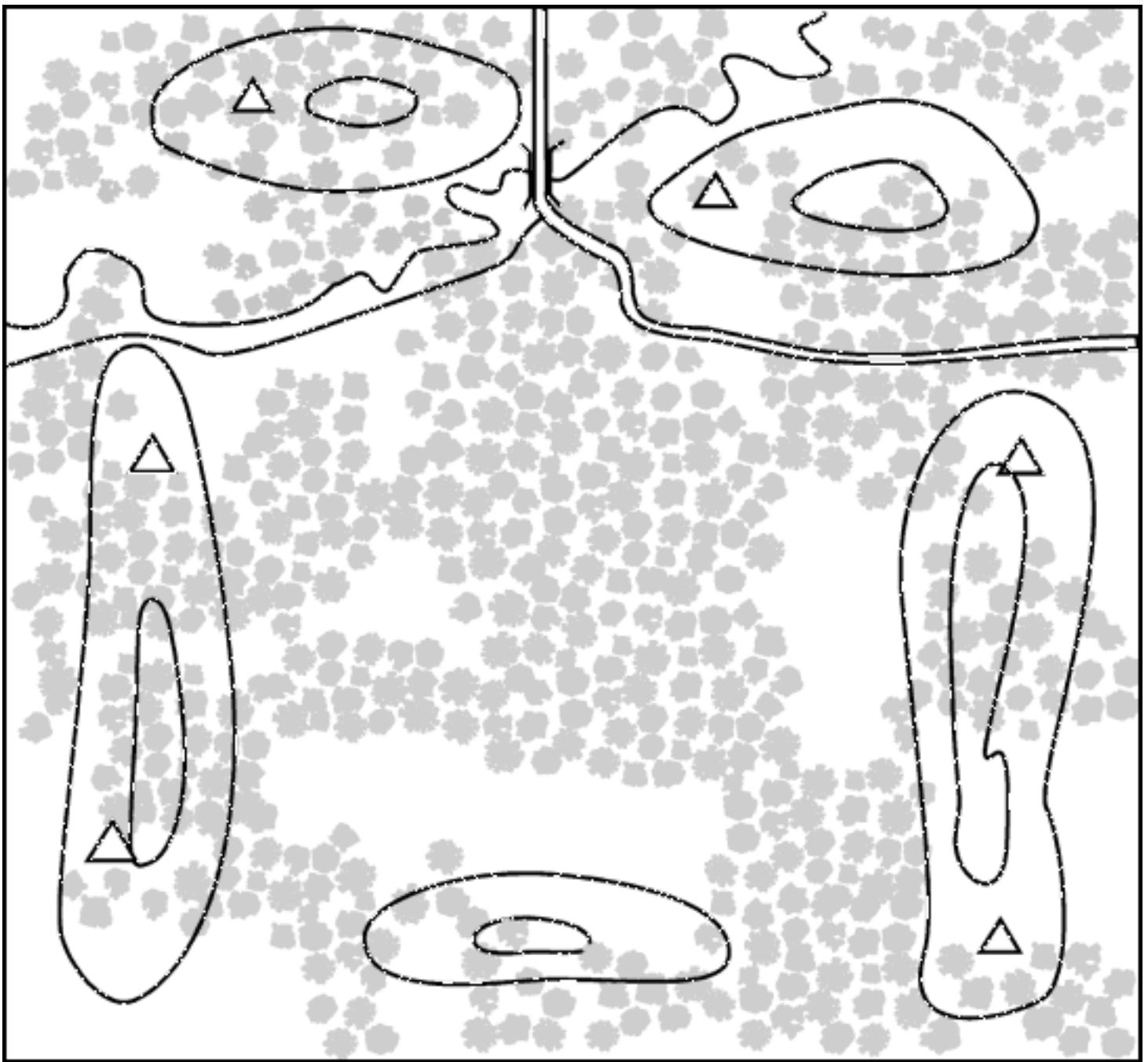

Figure 8-3. Figure 8-3. In-depth positioning of OPs.

Selecting an OP site

Based on his commander's guidance, the platoon leader selects the general location for the platoon's OPs after analyzing METT-TC factors. From his analysis, he determines how many OPs he must establish; he also decides where they must be positioned to allow long-range observation along the avenues of approach assigned by his commander and to provide depth through the sector. Section and squad leaders select the exact position for each OP on the ground. OPs should have the following characteristics:

- Covered and concealed routes to and from the OP. Scouts must be able to enter and leave their OP without being seen by the enemy.
- Unobstructed observation of the assigned area or sector. Ideally, the fields of observation of adjacent OPs overlap to ensure full coverage of the sector.

- Effective cover and concealment. Scouts select positions with cover and concealment to reduce their vulnerability on the battlefield. Scouts may need to pass up a position with favorable observation capability but with no cover and concealment to select a position that affords better survivability.
- A location that will not attract attention. OPs should not be sited in such locations as a water tower, an isolated grove of trees, or a lone building or tree; these positions draw enemy attention and may be used as enemy artillery TRPs.
- A location that does not skyline the observers. Avoid hilltops. Position OPs further down the slope of the hill or on the side, provided there are covered and concealed routes into and out of the position.

Occupying the OP

The scout platoon leader selects a technique to move to the screen line based on his analysis of METT-TC. Unless the area has already been cleared, the platoon should conduct a zone reconnaissance to the screen line. This is the most secure method of moving to the screen line, but also the most time-consuming. The following steps provide an example of how CFV-equipped scouts occupy an OP:

- A scout section stops short of its OP site. The section leader directs the drivers into positions to overwatch the general OP site and any terrain the enemy could use to dominate movement into or out of the position. (See [Figure 8-4](#).)
- The section leader dismounts with four scouts, two from each vehicle. The squad leader stays with the vehicles. Drivers and gunners remain on their vehicles to overwatch the dismounted personnel as they move forward to reconnoiter the OP.
- The section leader moves the dismounted scouts to the OP site, establishes security overwatching the far side of the site, and checks the site for mines, booby traps, and enemy personnel. He verifies that he can observe his sector or area of responsibility from this site and determines which exact position is best for the OP.
- The section leader selects hide positions and fighting positions for his two vehicles. Once the area around the OP is cleared and secure, he signals the vehicles forward to move into their fighting positions.
- The driver and a dismounted scout from each vehicle mark their vehicle position with a ground stake. The stake, which enables a vehicle to reoccupy the fighting position at a later time, is centered on the driver's station. It must be tall enough for the driver to see as he drives into position. The driver uses engineer tape or luminous tape on the stake so he can see it during limited visibility operations.
- The gunner and vehicle commander for each vehicle complete and check their sector sketch. Each vehicle then moves back out of its fighting position into a hide position. The section leader checks the sketches to ensure they provide complete coverage of the sector. Sector sketches or range cards allow the OP to use the CFV's thermal sights for observation; they are also a valuable reference if the vehicle is ordered to fight.

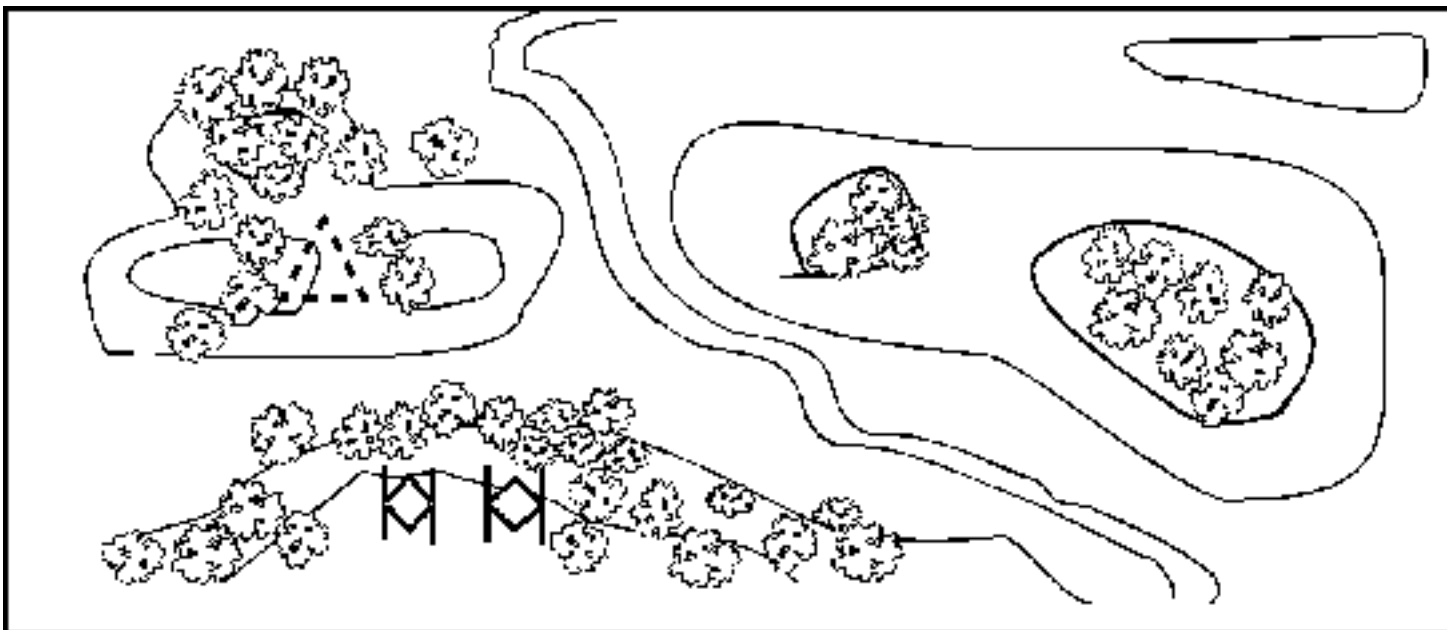

Figure 8-4. CFVs overwatching potential OP site.

NOTE: A HMMWV-equipped platoon will occupy an OP in the same manner as the CFV platoon; however, the section leader will take only one scout from each vehicle in the section.

Manning the OP

A minimum of two scouts man each OP. They must be equipped to observe the area, report information, protect themselves, and call for and adjust indirect fire. One scout observes the area while the other provides local security, records information, and sends reports to the section/squad leader or platoon leader. The two scouts should switch jobs every 20 to 30 minutes because the observer's effectiveness decreases quickly after that time. Essential equipment for the OP includes the following:

- Map of the area.
- Compass.
- Communications equipment (wire and/or radio).
- Observation devices (binoculars, observation telescope, and/or night vision devices).
- SOI extract.
- Report formats contained in the SOP.
- Weapons (personal, crew-served, and/or light AT weapons; mines are included, if necessary).
- Seasonal uniform and load-bearing equipment (LBE).

Improving the position

Once the section leader has established the OP and assigned the scouts their sectors of observation, the section improves the position. The section leader prepares a sector sketch. This sketch is similar to a fighting position sketch but with some important differences. As a minimum, the sketch will include the following: a rough sketch of key and significant terrain; the location of the OP; the location of the hide position; the location of vehicle fighting and observation positions; alternate positions (hide, fighting, observation); routes to the OP and fighting positions; sectors of observation; preplanned artillery targets;

TRPs for direct fire; and prepared spot reports and calls for fire, based on trigger lines and projected locations where the enemy will first be seen. [Figure 8-5](#) shows a sample of a section leader's sector sketch for an OP.

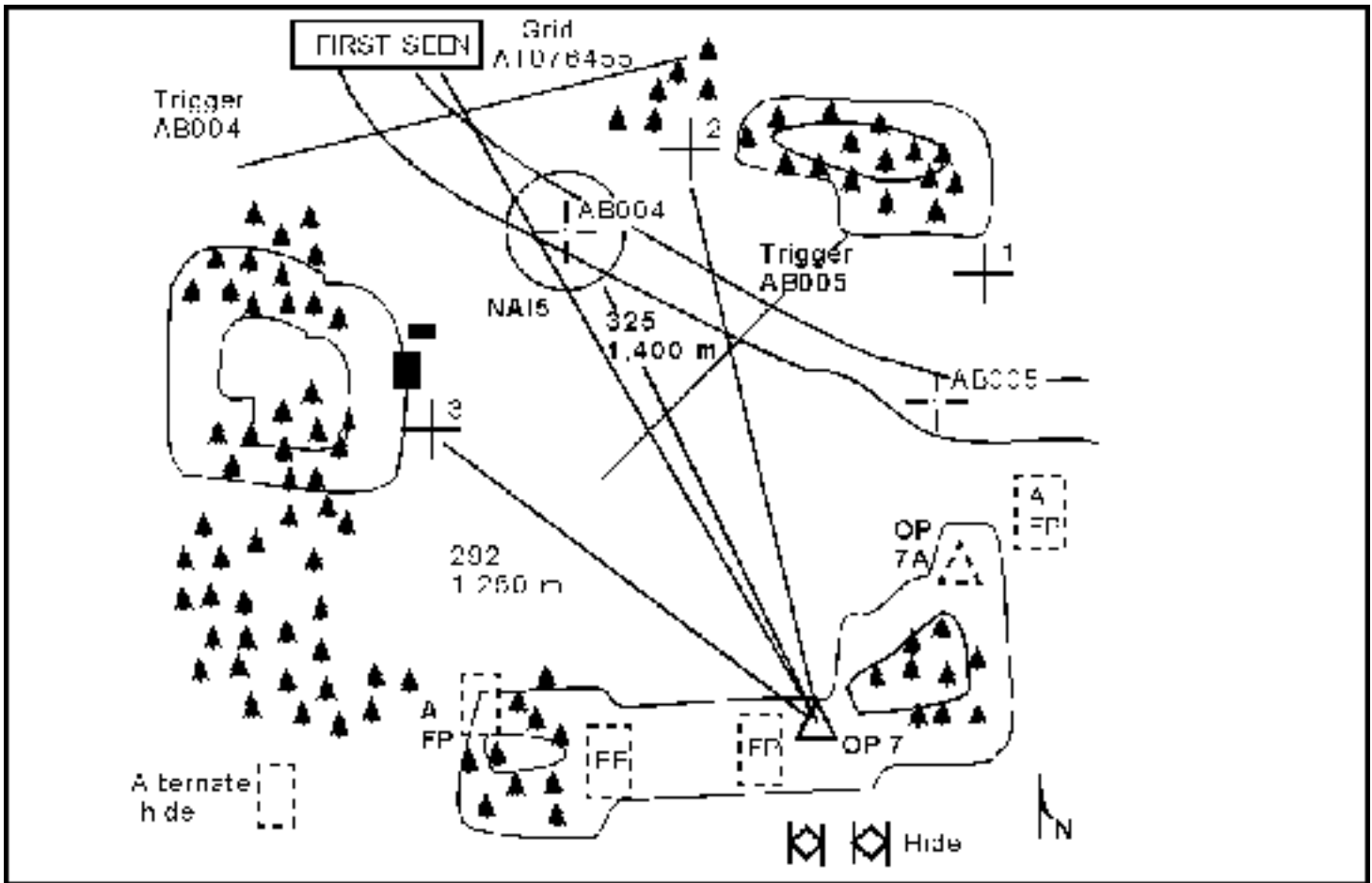

Figure 8-5. Section leader's OP sketch.

Personnel manning the OP site begin digging in to provide protection from indirect and direct fires. They also camouflage the position, install wire communications equipment and directional antennas for FM communications, and emplace hasty obstacles for local protection. Vehicle commanders (or gunners) and drivers reconnoiter the routes to their fighting/observation positions and alternate positions, perform maintenance, and camouflage vehicles and positions.

OP communications

The scouts occupying the OP use wire, radio, or both as their primary means of communications. Wire is preferred because it is secure and is not vulnerable to enemy direction-finding equipment or jamming. The scouts can conceal the wire so the enemy cannot see it.

Wire is the best way for the scouts in the OP to communicate with their section/squad leader or his representative, who is located with his vehicle in the hide position behind the OP. The scout in the vehicle in turn relays reports or information to the platoon leader by radio. Ideally, if the vehicles are in a hide position, their signals are masked from the enemy by terrain. If they anticipate being in the position for a long period of time, scouts should construct a directional antenna to further reduce their vulnerability to enemy jamming or direction-finding. The scouts in the OP should carry a radio as a backup means of communications; they can use it to send reports or to talk directly to their FSO for

indirect fire support.

OP security

Scouts are extremely vulnerable in an OP; their best self-defense is not to be seen, heard, or otherwise located by the enemy. They employ active and passive measures to protect themselves from enemy detection and direct and indirect fires.

The first step is to locate the OP in a covered and concealed position to reduce the chance of being seen by the enemy. The scouts add camouflage to the position to enhance natural concealment. If they have enough time, they dig in the position and add overhead cover to increase survivability against enemy fires. The scouts enforce strict light and noise discipline and reduce activity in and around the OP to essential movement only.

Wire communications reduce the scouts' signature in the OP. If they must use the radio, they use a directional antenna whenever possible and mask their transmissions from the enemy. They keep all vehicles hidden because the enemy can easily identify their large signatures. To provide early warning of enemy movement around the screen line or OP position, scouts emplace their PEWS in areas that they cannot observe or in the dead spaces between OPs. Trip flares and M18A1 claymore mines provide additional early warning and protection from enemy personnel.

Active patrolling around and between OPs also enhances security. Patrols give scouts the ability to observe areas that cannot be observed from the OPs and to clear the area around the OP of enemy elements. They execute security patrols as soon after occupation of the position as possible to discover enemy elements that might have observed the occupation. The patrol reconnoiters favorable observation positions that might be occupied by the enemy. Route selection is critical when organizing these patrols because the scouts must assume that the OP position is under observation. Refer to the discussion of patrols later in this section.

OPs cannot always avoid being seen by the enemy, so they must take actions to limit their vulnerability. Covered positions provide protection from enemy fires; vehicle dispersion further reduces the effects of these fires. The vehicles in the fighting positions are used to extricate the scouts from the OP when the position has been identified and attacked by the enemy.

PATROLS

A patrol is a detachment sent out by a larger unit to conduct a reconnaissance or combat operation. The operation itself is also called a patrol. Patrolling plays an extremely important role in scout operations. Patrol missions are normally conducted by a section or squad, but there are specific situations in which the entire platoon may be dedicated to patrolling. In any situation, however, scouts can conduct extensive patrolling only if they are organized with sufficient personnel and other resources to execute the particular patrol mission. [Figure 8-6](#) illustrates how patrols are integrated into a screen.

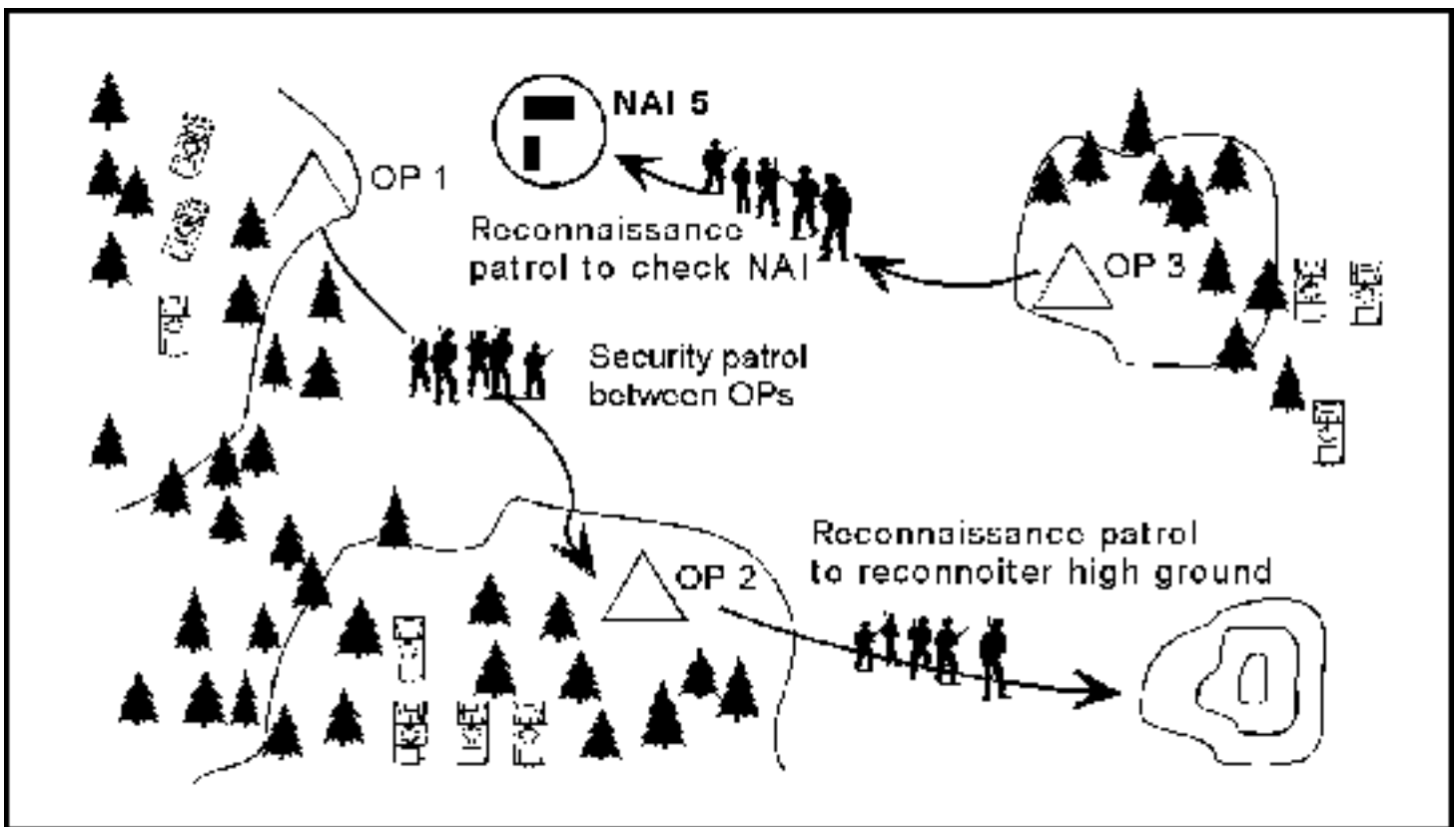

Figure 8-6. Integration of patrols into the screen.

In general, the scout platoon may be tasked to conduct three types of patrols: reconnaissance, combat, and tracking. These are described later in this section. Refer to [FM 7-8](#) for a detailed discussion of patrol operations, including organization, planning considerations, and execution.

Types of patrols

Reconnaissance patrols. Reconnaissance patrols are normally tasked at platoon level or higher to gather detailed information on the enemy, terrain, or specific NAIs or avenues of approach. A reconnaissance patrol objective might be a small mounted avenue of approach that the platoon does not have assets to cover continuously. Reconnaissance patrols can also ensure the security of OPs and the integrity of the platoon's area of operations; when executed as part of a screen or other security mission, this type is sometimes referred to as a security patrol. A scout section can send out a reconnaissance patrol after establishing an OP to check all locations from which the enemy can observe the OP; this will ensure the OP position was not detected as it was occupied. (**NOTE:** [Chapter 3](#) of this manual includes a discussion of the reconnaissance patrol in scout platoon reconnaissance operations.)

Combat patrols. The platoon may conduct a combat patrol as part of the counterreconnaissance effort, though this type of patrol is not common for the scout platoon because of the personnel and resources required. As an example, the platoon might use a combat patrol to establish an ambush on a dismounted enemy avenue of approach and prevent dismounted infiltration of the screen line. If combat patrols are routinely required, however, infantry elements should be tasked to conduct them.

Tracking patrols. A tracking patrol is conducted to follow the trail of a specific enemy unit, though this is a relatively rare assignment for the scout platoon. In this role, scouts look for signs left by the enemy. As they track the enemy unit, they gather information about the route and surrounding terrain.

Patrol orders

[Figure 8-7](#) shows a sample format for a patrol FRAGO. It is organized in the standard five-paragraph outline and includes examples of information that can be included.

<p>TASK ORGANIZATION: Explain the organization of the patrol and confirm the composition of each patrol element.</p> <ol style="list-style-type: none"> 1. SITUATION. <ol style="list-style-type: none"> A. Enemy situation: expected size, location, and disposition of enemy forces the patrol may encounter. B. Friendly situation: activity and location of the mounted element, other elements in the area, and the platoon. C. Attachments/detachments: any special personnel or elements (such as engineers, medics, or FOs) who will accompany the patrol. 2. MISSION. Specifically state what type of patrol and the reason for the patrol (for example, to secure an area from which the enemy might be able to observe an OP site). 3. EXECUTION. <ol style="list-style-type: none"> A. Scheme of maneuver: primary and alternate routes, RPs, and ORPs, as well as any other critical graphic control measures. These should be listed sequentially as they will occur in the patrol, with reference to a map or dirt sketch. B. Subordinate team instructions: primary mission statements for individual subordinate teams. C. Coordinating instructions, focusing on key considerations such as the following: <ol style="list-style-type: none"> 1) Special equipment. 2) Actions on contact. 3) Movement techniques. 4) Linkup with the mounted element. 5) PIR (if applicable). 4. SERVICE SUPPORT. Key considerations include the following: <ol style="list-style-type: none"> A. Method of handling KIA and WIA personnel. B. Method of handling EPWs. 5. COMMAND AND SIGNAL. <ol style="list-style-type: none"> A. Command. <ol style="list-style-type: none"> 1) Chain of command. 2) Location of leaders. B. Signal. <ol style="list-style-type: none"> 1) Challenge and password. 2) Key hand-and-arm signals. 3) Code words or reports due.
--

Figure 8-7. Sample format and information for a patrol FRAGO.

REMOTE ELECTRONIC/MECHANICAL SURVEILLANCE

In some cases, the scout platoon will not have the resources to observe a particular area that is either tasked to the platoon or important to its internal security. Other times, the terrain will not permit such observation. In these situations, the platoon can use mechanical warning devices such as trip flares or electronic devices such as PEWS to monitor the area.

As a general consideration, remote surveillance devices allow the platoon to put maximum effort into the commander's or scout's primary area of concern while still maintaining surveillance on secondary reconnaissance objectives. The platoon will back up these devices with patrols to investigate any alarms. An example of the use of mechanical devices is an OP that uses trip flares in dead space along the avenue of approach it is monitoring. When activated, the trip flare gives early warning of enemy infiltration. A patrol will then be dispatched to verify the warning. See [Figure 8-8](#).

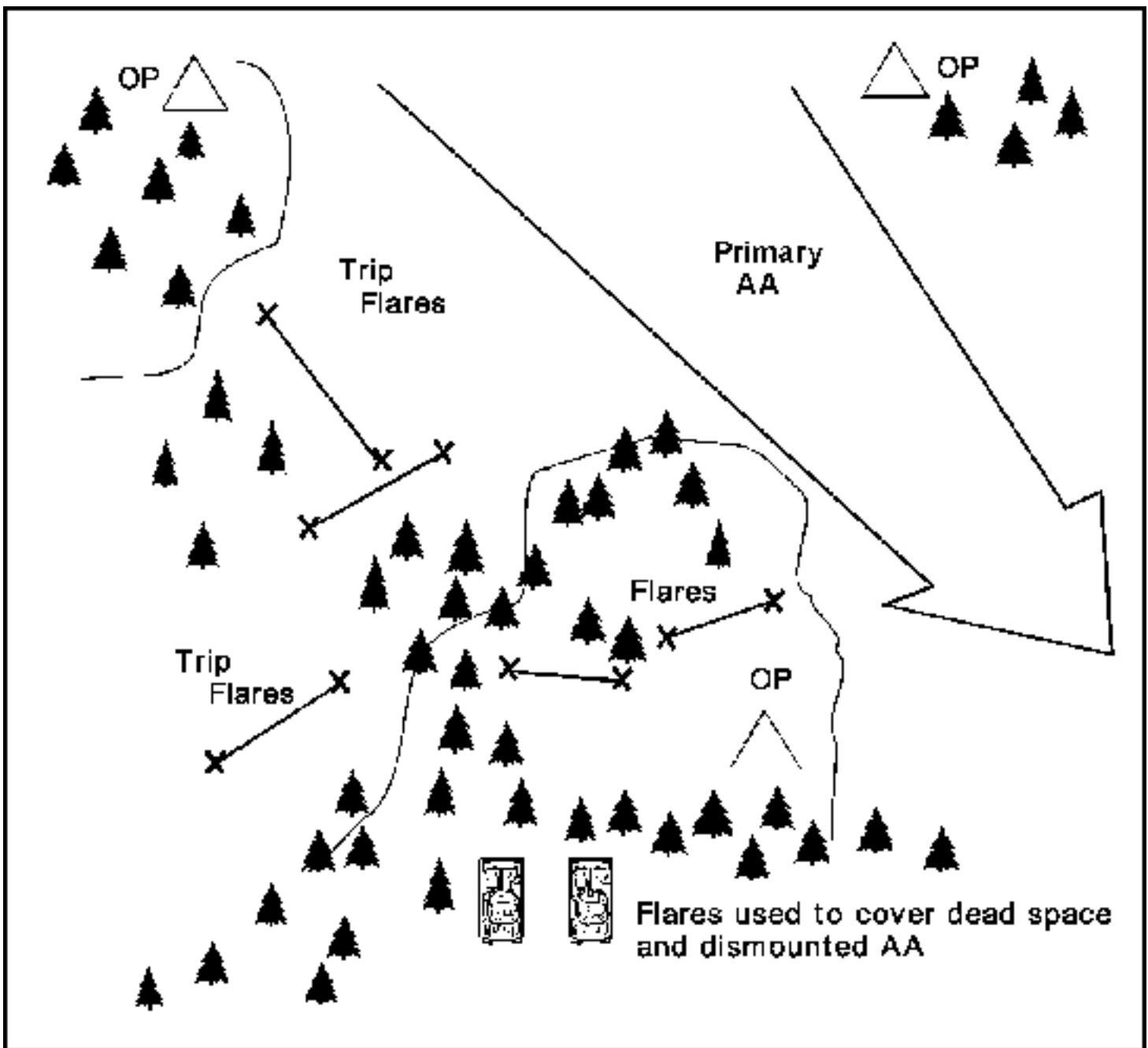

Figure 8-8. Integration of remote devices into the screen.

SECTION 3 — VEHICLE POSITIONS

Between moves or while occupying an overwatch position, a scout vehicle occupies one of three types of hasty positions: hide, turret-down, or hull-down. (NOTE: Refer to [Figure 8-9](#) for an illustration.) The scout vehicle approaches the intended location from the rear along a covered route and occupies the desired position at the commander's direction.

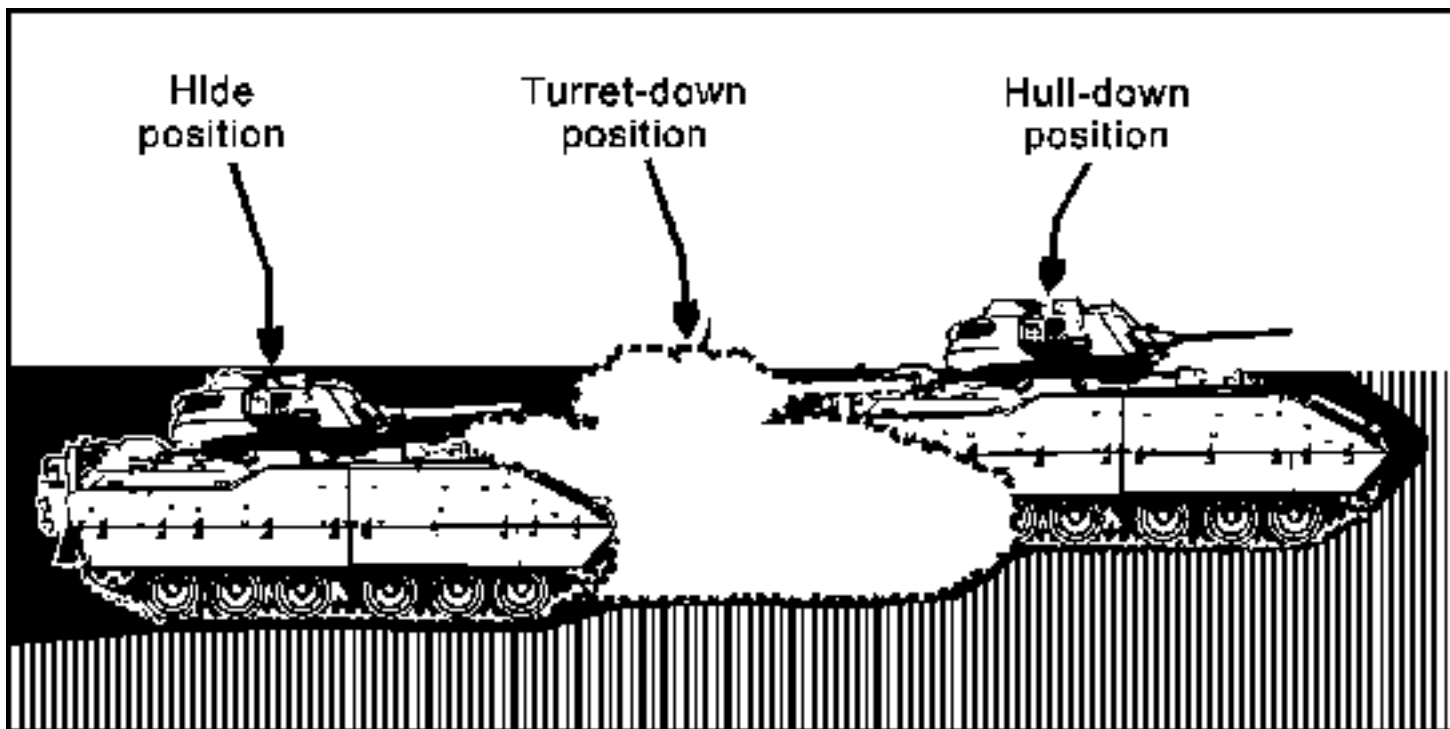

Figure 8-9. Hide, turret-down, and hull-down positions.

HIDE POSITION

In this position, the vehicle commander hides the vehicle so that no part is exposed to the front. A dismounted observer must maintain visual contact with the assigned sector. This position is used when enemy engagement is not imminent and stealth is desired or when a vehicle is moving to avoid direct fire from an undetected enemy.

TURRET-DOWN POSITION

In this position, the vehicle commander halts the vehicle when the entire vehicle is behind cover but the commander can still observe the assigned sector from his position. The turret-down position is used when enemy engagement is possible and stealth is still desired. When engagement is required, the vehicle moves into a hull-down position at the direction of the vehicle commander.

HULL-DOWN POSITION

This position is used to engage an enemy element. The vehicle commander halts the vehicle as soon as the gunner can view and engage the target area. The rest of the vehicle remains behind cover.

NOTE: Platoons that are equipped with HMMWVs use hide and hull-down positions as required (see [Figure 8-10](#)). In the hull-down position, only the vehicle gunner and weapon system are exposed.

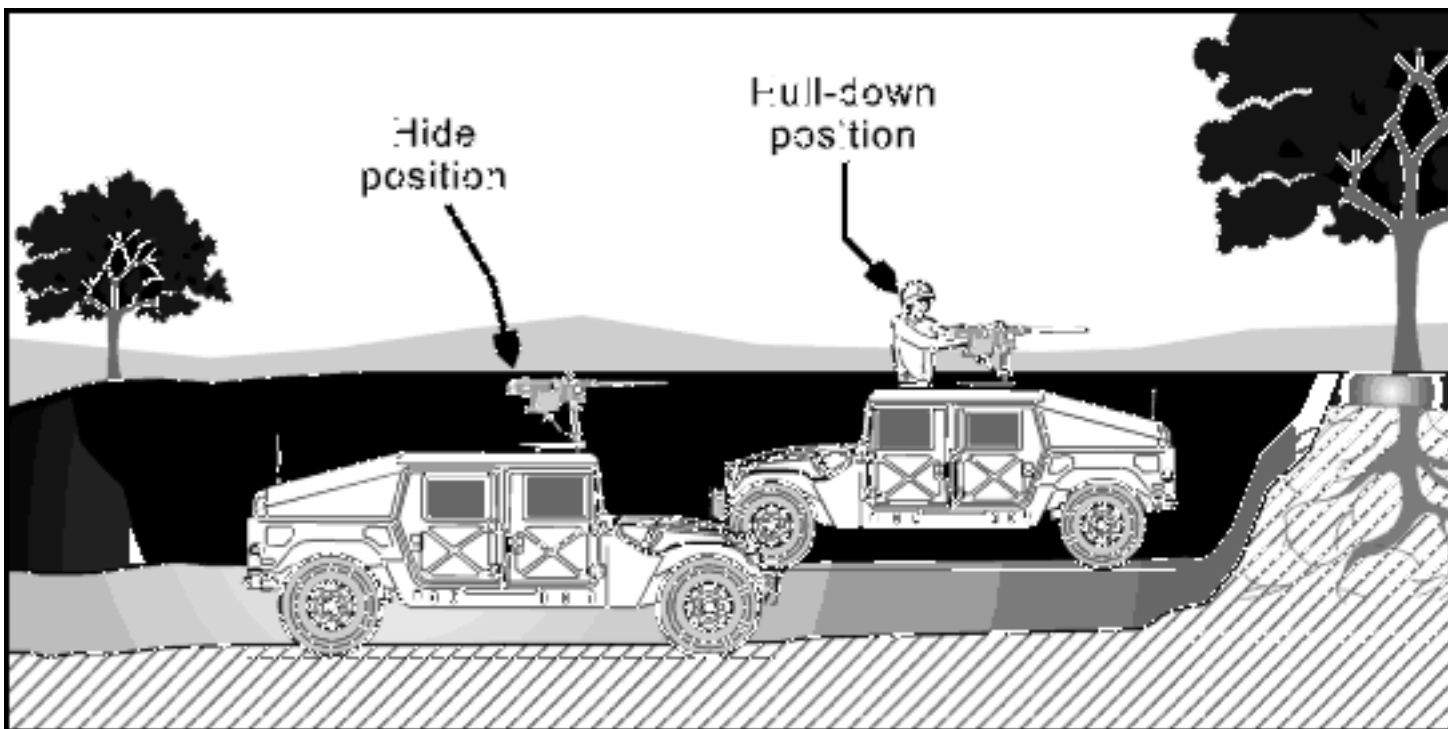

Figure 8-10. HMMWV hide and hull-down positions.

SECTION 4 — FORMATIONS

The scout platoon uses formations to facilitate positive command and control by the platoon leader, to increase speed in execution, and to reduce confusion. Formations provide a standard position for each section or squad in relation to other elements.

Unlike the infantry or armor platoon, the scout platoon does not normally use formations to execute its tactical reconnaissance or security missions. This is because the platoon's primary maneuver elements, the scout section and squad, rarely maneuver within mutually supporting distance of other friendly elements.

PLATOON FORMATIONS

The scout platoon most often uses formations at the platoon level when operating behind the forward edge of the battle area (FEBA) where enemy contact is not expected. It may, however, employ combat formations when terrain supports their use, such as in desert operations; when the mission or reconnaissance objective is very focused, such as in a route reconnaissance; or when the platoon is participating in the combat mission of a higher headquarters, such as movement to contact or hasty attack. Normally, platoon formations are not appropriate to the execution of a reconnaissance or security mission.

There are six scout platoon formations: line, vee, column, staggered column, coil, and herringbone. Movement into and out of the various formations must be second nature to each squad. Formations are intended to be flexible and to be modified to fit the situation, terrain, and combat losses; they do not have exact geometric dimensions and design.

NOTE: The illustrations accompanying the following discussion show a CFV platoon in various formations. The HMMWV platoon relies on the same basic formations to accomplish its mission. Unlike the CFV scout platoon, however, the HMMWV scout platoon should not be employed in combat missions such as hasty attack or movement to contact; therefore, it is even less likely than the CFV platoon to use platoon formations forward of the FEBA.

Line

This formation can be used regardless of the platoon organization and is applicable to most scout platoon missions. It allows the platoon to cover the most ground systematically, with maximum reconnaissance forward. (See [Figure 8-11](#).)

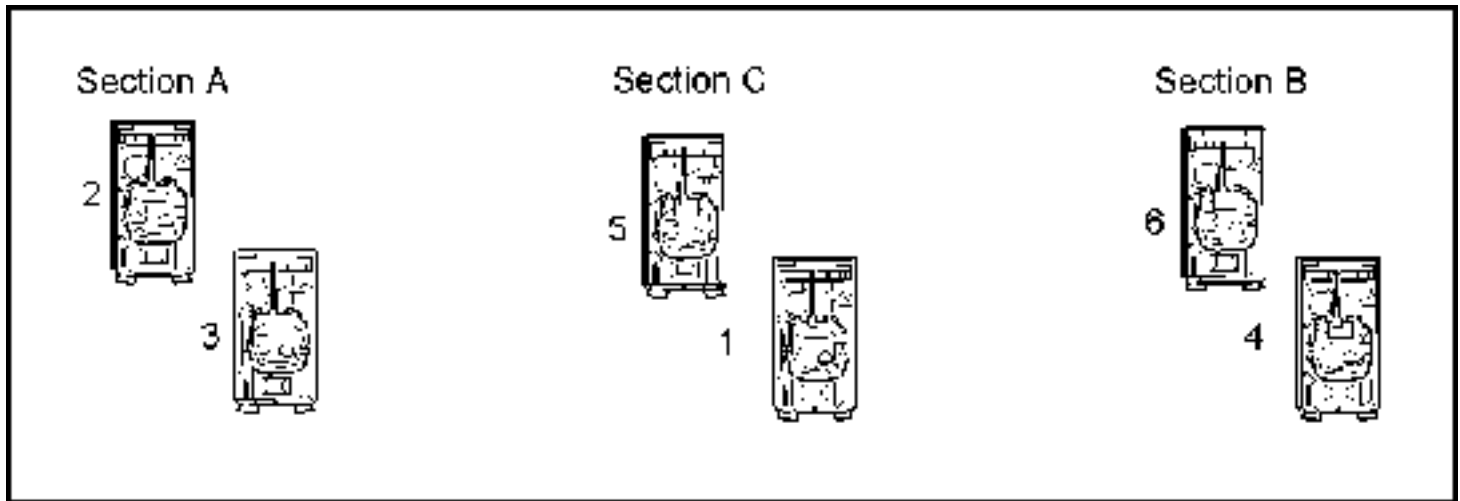

Figure 8-11. Three-section platoon line formation.

Vee

This formation uses the three-section organization. The platoon maintains relative positioning based on terrain and combat losses. The vee lends itself to immediate mutual support and provides depth; it is very flexible. Using any of the techniques of movement, the two forward sections perform all of the information gathering and reporting. The rear section provides overwatch and command and control. (See [Figure 8-12](#).)

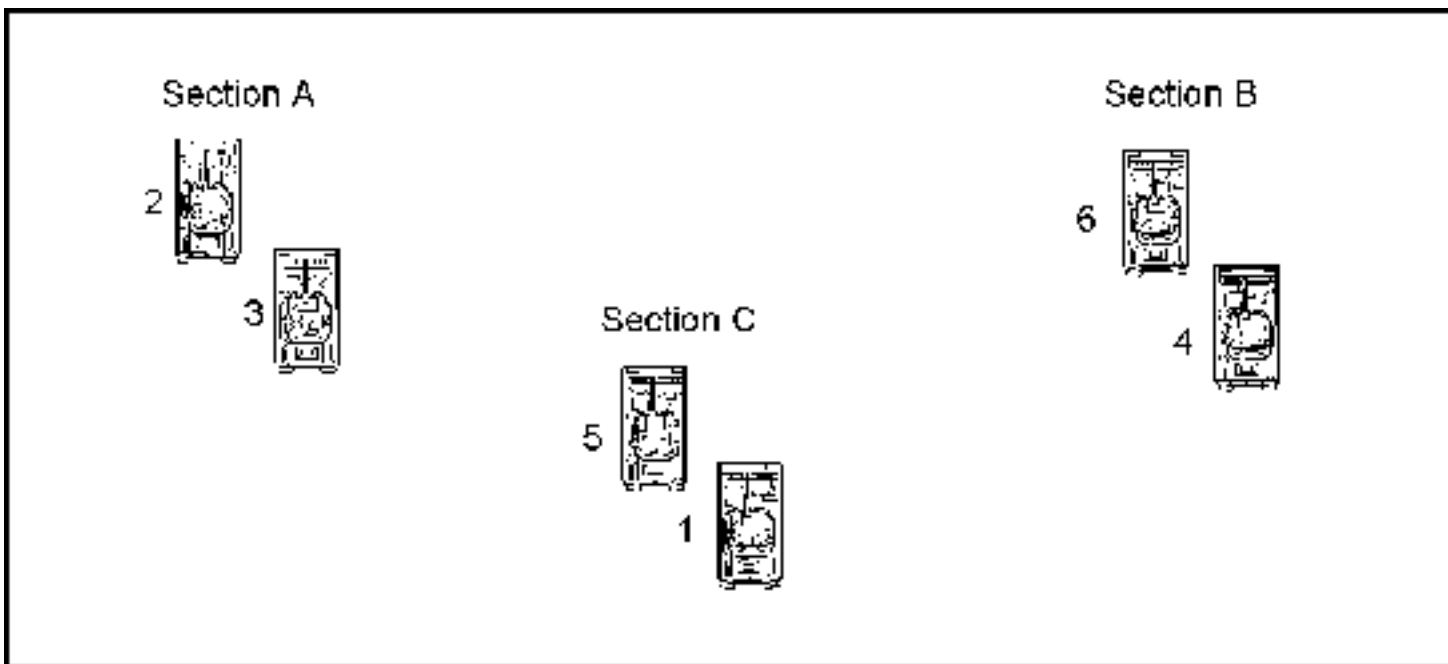

Figure 8-12. Three-section platoon vee formation.

Column and staggered column

The platoon uses the column formation when speed is essential as it moves on a designated route (see [Figure 8-13](#)). The column offers protection to the flanks, but little to the front and rear. Normally, the platoon leader briefs the section leaders on the route and speed and then allows the lead section to control the column movement. This frees the platoon leader to concentrate on the subsequent mission, enhancing command and control. It does not, however, relieve him of the responsibility of tracking the move on his map.

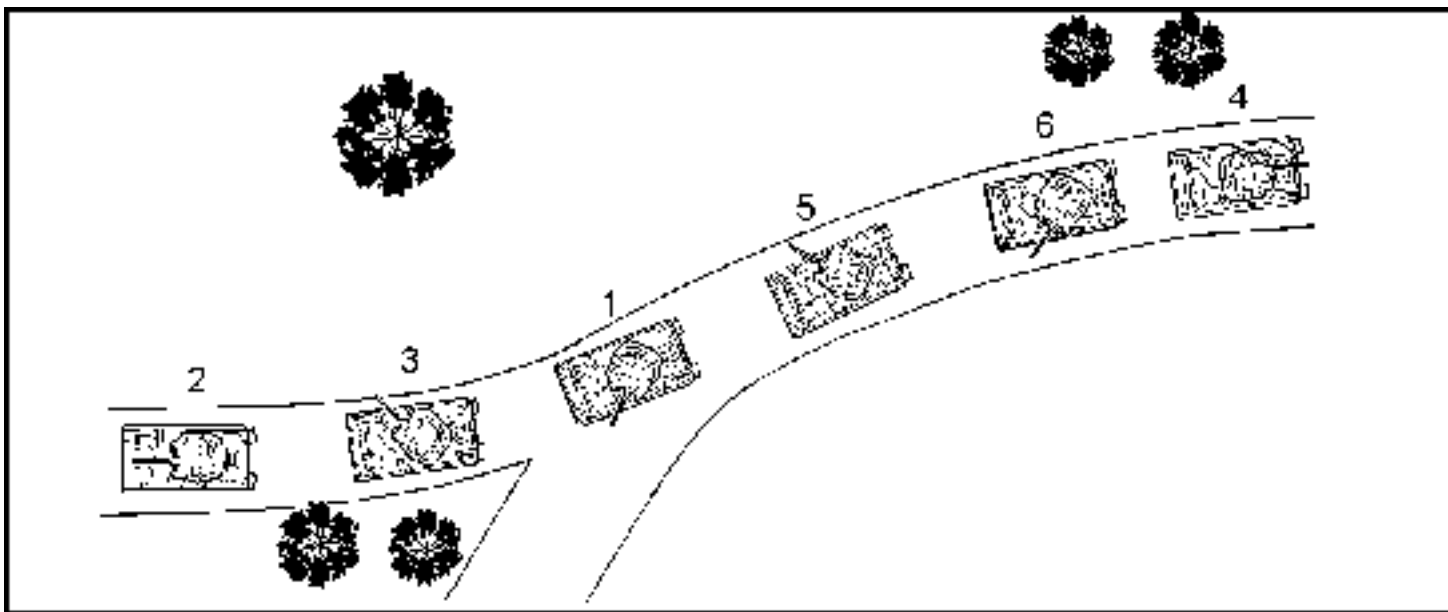

Figure 8-13. Platoon column formation.

The order of march may depend on which organization the platoon will use at the end of the movement; in addition, the lead section may vary based on METT-TC considerations. When conducting movement in a secure area, it is appropriate to specify the order of march by SOP.

The staggered column is used for rapid movement across open terrain. It affords all-around observation and fields of fire. [Figure 8-14](#) shows the platoon in the staggered column in a two-section organization with Alpha section leading.

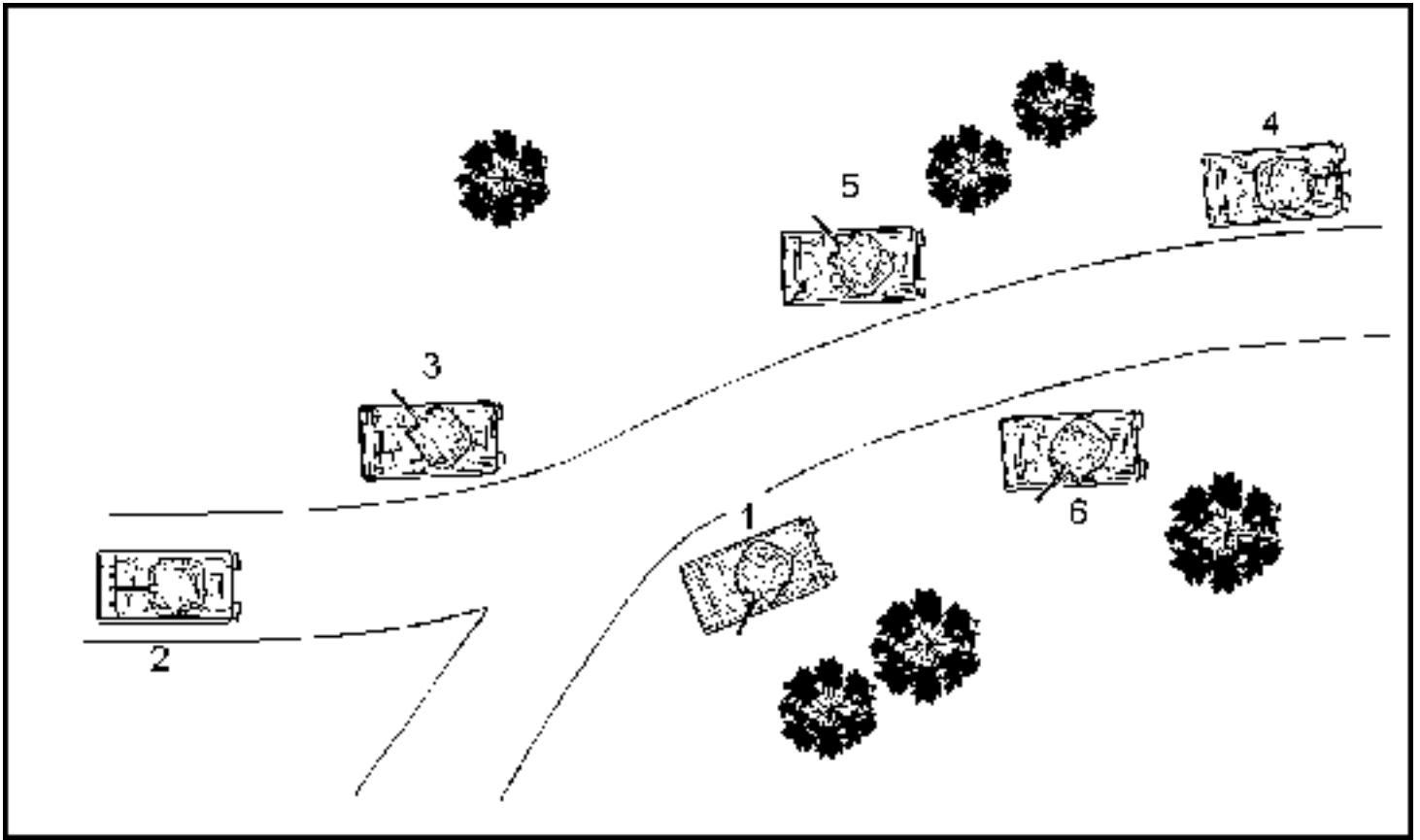

Figure 8-14. Platoon staggered column formation.

Coil

The platoon coil is used to provide all-around security during halts. Each vehicle has a particular position to occupy in the coil. The platoon leader designates the orientation of the coil using a cardinal direction; in the absence of orders, the direction of travel becomes 12 o'clock. Platoons must develop a coil SOP based on their mission essential task list (METL), war plans, and most frequently used organizations. The SOP should be practiced as a drill so that correct execution of the coil becomes automatic.

The coil is always executed from the column or staggered column, with the platoon using the six-vehicle organization. The lead vehicle occupies the 12 o'clock position. The other vehicles occupy the 2, 10, 4, 8, and 6 o'clock positions in accordance with the order of march. Vehicles are positioned 100 to 150 meters apart. An example is illustrated in [Figure 8-15](#).

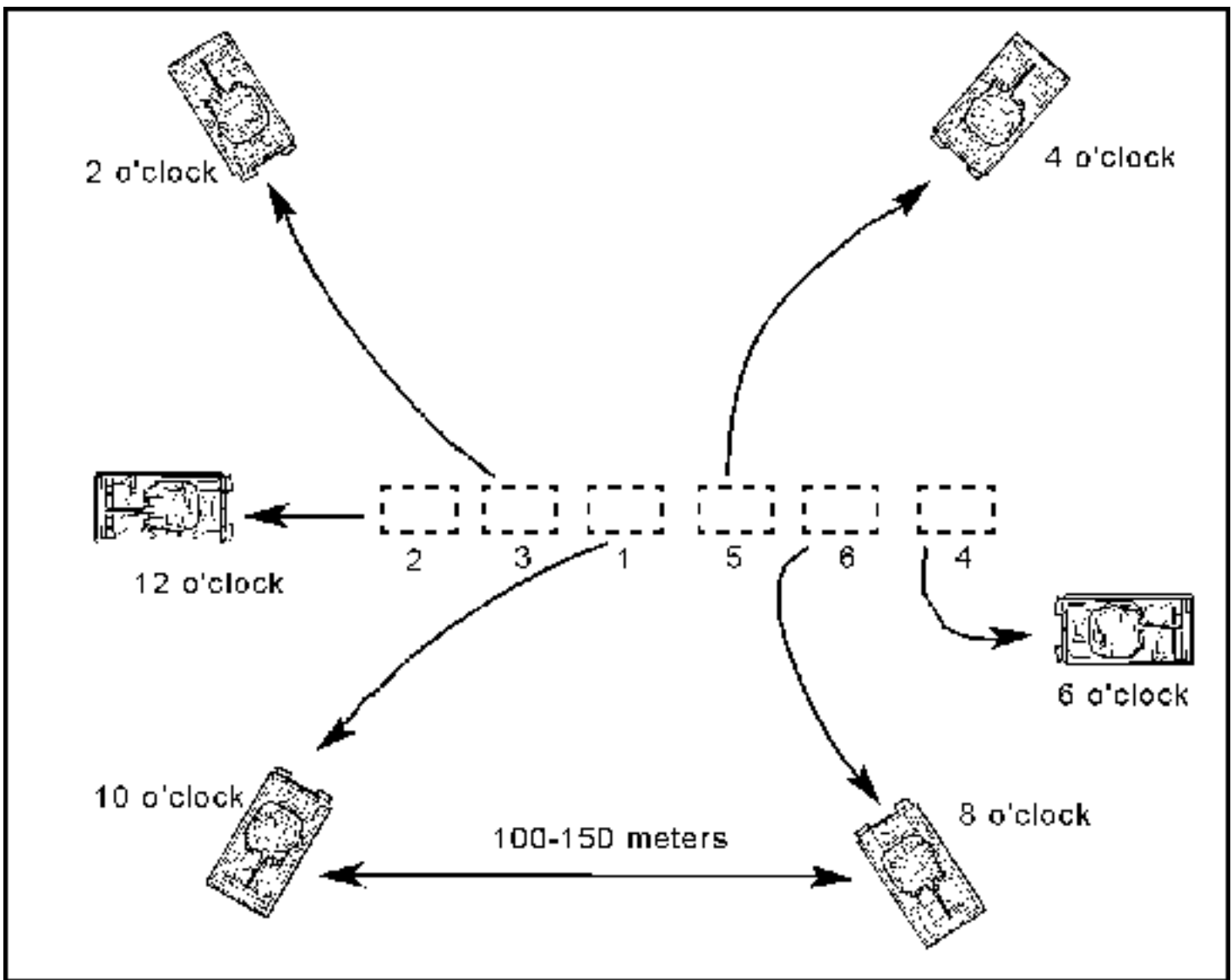

Figure 8-15. Example CFV platoon coil formation.

Herringbone

The herringbone is used to provide 360-degree security during a temporary halt from a march column (see [Figure 8-16](#)) scouts should dismount to provide greater security. The formation may be widened to permit passage of vehicles down the center of the column. All vehicles should move completely off the road if terrain allows.

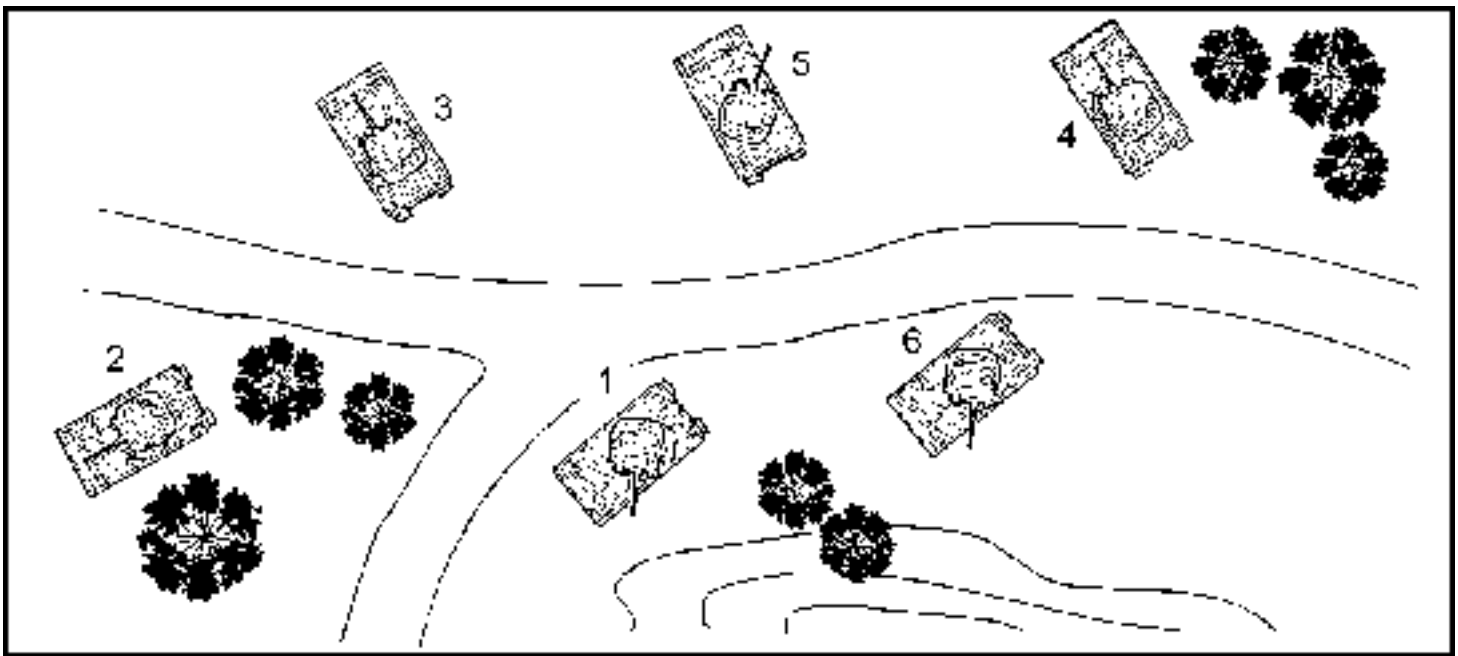

Figure 8-16. Platoon herringbone formation.

SECTION FORMATIONS

When the platoon operates in a configuration with two sections of three vehicles each, the individual sections can employ formations of their own. [Figure 8-17](#) illustrates the two three-vehicle section formations: vee and wedge. The vee formation provides maximum reconnaissance forward and speeds the rate of reconnaissance while using a single vehicle for overwatch. The wedge formation provides maximum security, with two vehicles overwatching the reconnoitering vehicle forward.

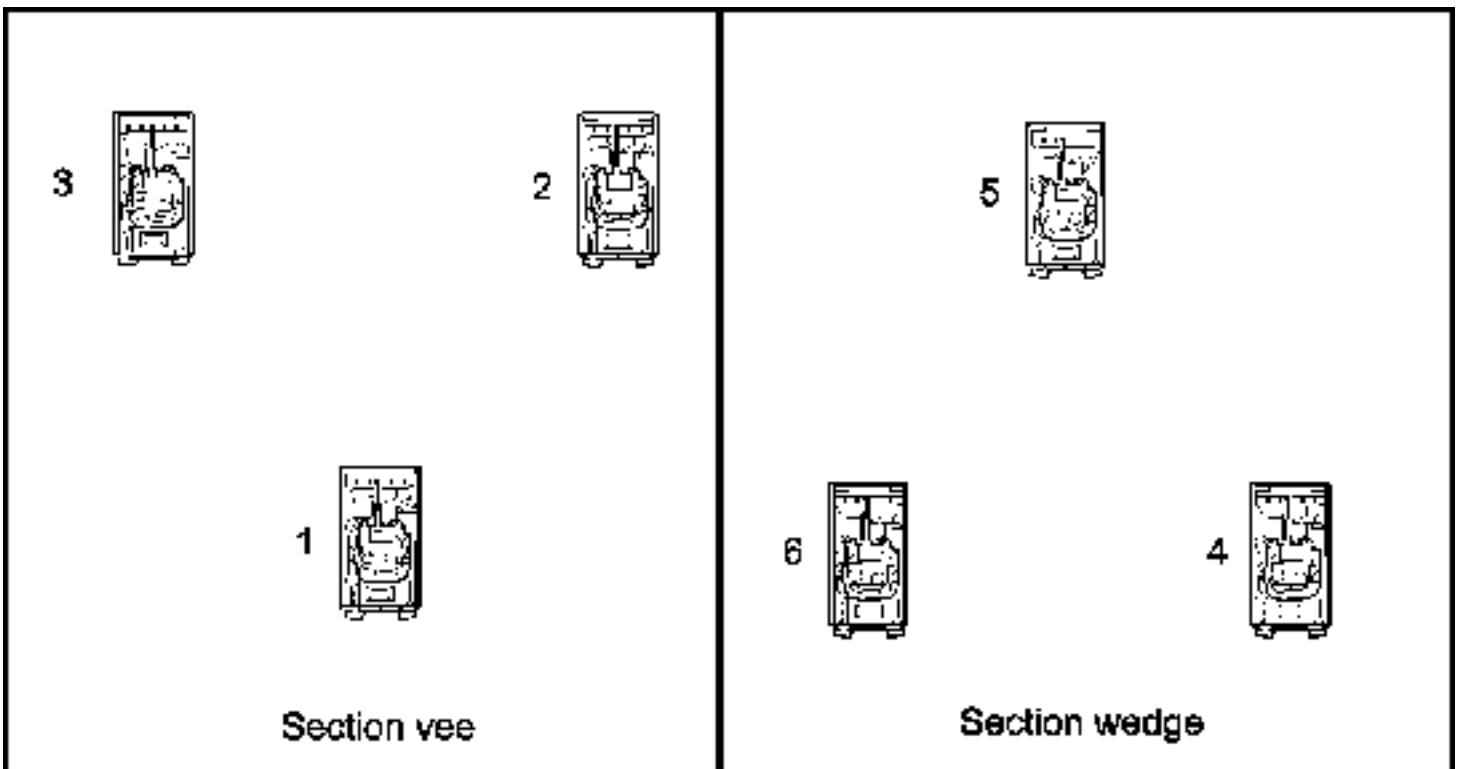

Figure 8-17. Section vee and wedge formations.

SECTION 5 — MOVEMENT TECHNIQUES

The scout platoon employs movement techniques for a number of reasons: to minimize its exposure to enemy fire, to help the platoon maintain freedom of movement, to maximize the number of tactical options available to the platoon, and to place it in position to react effectively to enemy contact. Effective employed, movement techniques allow the platoon to make enemy contact with its smallest element: the dismounted scout.

At the same time, however, movement techniques alone are not enough to guarantee accomplishment of these tactical goals. The platoon must use them in conjunction with other movement- and security-related measures. For example, scouts must make maximum use of all available natural cover and concealment when moving. In addition, they must avoid becoming vehicle-bound; they must be prepared to dismount to improve observation, prevent enemy detection, and provide security.

The scout platoon uses three movement techniques on the battlefield: traveling, traveling overwatch, and bounding overwatch. These techniques provide a standard method of movement, but the scout must use common sense in employing them as he performs his missions and encounters different situations. The decision of which technique to use is based in large part on the likelihood of enemy contact; in general, this can be summarized as whether contact is not likely (traveling), possible (traveling overwatch), or expected (bounding overwatch). Terrain considerations may also affect the choice of movement technique.

In the conduct of most tactical missions, the scout platoon will move as separate sections or squads under the command and control of the platoon leader. Traveling overwatch and bounding overwatch, therefore, are most often executed at the section or squad level. Traveling, which is usually employed behind the FEBA, is used equally at the section and platoon levels.

Regardless of which technique is used, the scout section leader gives the section an order explaining what each squad will do. This becomes more critical as the likelihood of enemy contact increases. If possible, the section leader should provide his squads with the following information:

- The enemy situation as he knows or suspects it to be.
- The next overwatch position (the objective for the bounding element).
- The route of the bounding element to that position.
- What he wants the section to do after the bounding element gets to the next position.

TRAVELING

In this technique, the lead and trail elements move together as a unit. It is the fastest but least secure movement technique. It is used when speed is important and enemy contact is not likely. Movement is continuous, and interval and dispersion are maintained between squads as terrain and weather permit. The platoon does not intend to engage in combat, but it is dispersed to prevent destruction in case of unexpected air or ground attack. When using this technique, the platoon could be in a column formation or dispersed in its other formations (see [Figure 8-18](#)).

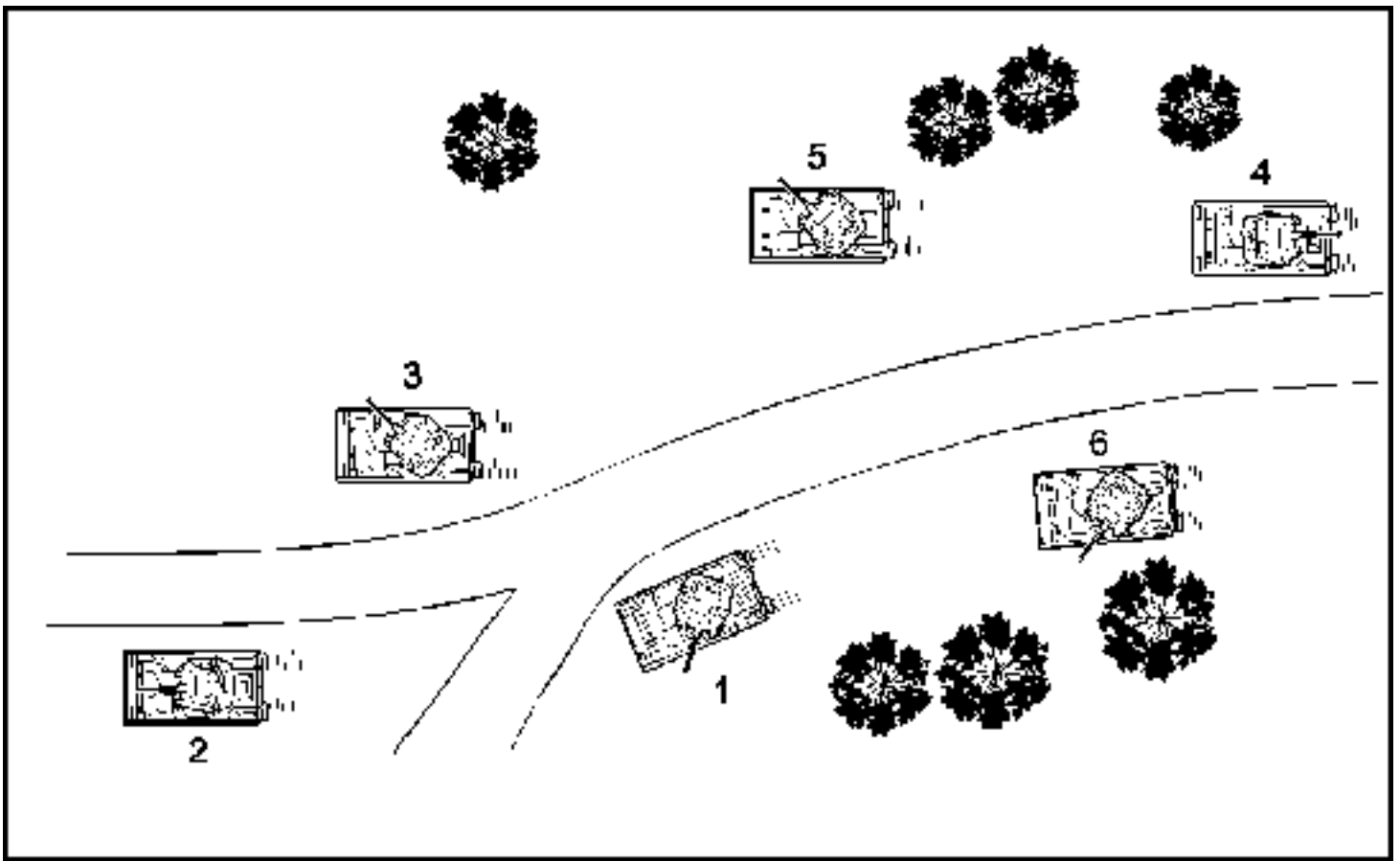

Figure 8-18. Platoon using traveling technique and staggered column formation.

TRAVELING OVERWATCH

Traveling overwatch is used when contact is possible but speed is desirable (see [Figure 8-19](#)). The lead element moves continuously along covered and concealed routes that afford the best available protection from possible enemy observation and direct fire. The trail element moves at variable speeds, providing continuous overwatch. It normally maintains contact with the lead element and may stop periodically for better observation. The trail element tries to stay one terrain feature behind the lead element but close enough to provide immediate suppressive fire and to maneuver for support. It must, however, be far enough to the rear to avoid contact in case the lead element is engaged by an enemy force.

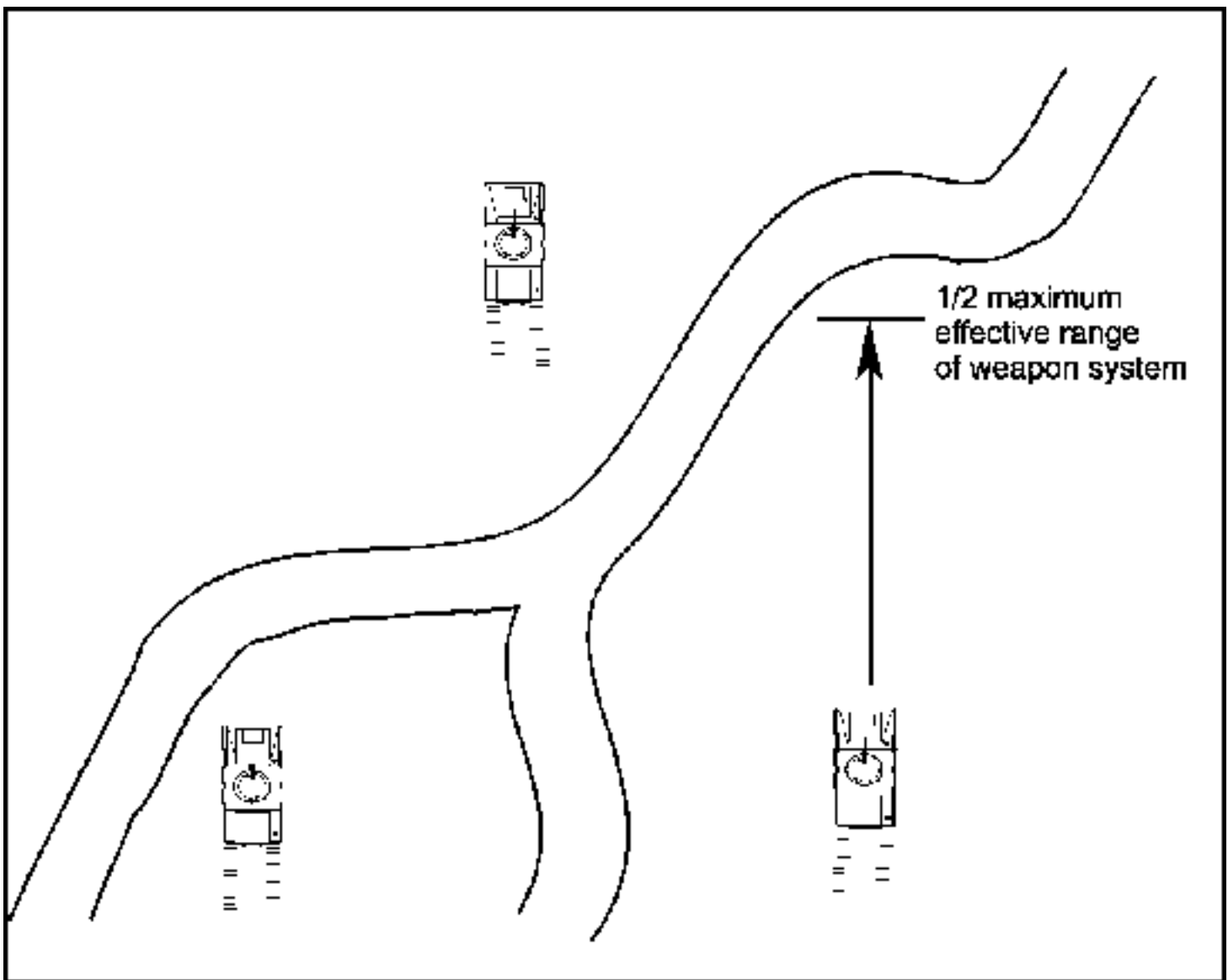

Figure 8-19. Section using traveling overwatch technique and wedge formation.

BOUNDING OVERWATCH

Bounding overwatch, the slowest but most secure movement technique, is employed when enemy contact is expected. It should always be used when time is available regardless of the likelihood of enemy contact. It provides for immediate direct fire suppression on an enemy force that engages the bounding element with direct fire.

In bounding overwatch, one element is always stopped to provide overwatch. The trail element first occupies a covered and concealed position from which it can overwatch the lead element. Upon completing its movement (bound), the lead element then occupies a similar position and provides overwatch as the trail element bounds forward to its next overwatch position. Bounding overwatch can be executed using one of the following bounding methods:

- Alternate bounds, in which the trail element advances past the lead element to the next overwatch position. This method is usually more rapid than successive bounds.
- Successive bounds, in which the trail element moves to an overwatch position that is

approximately abreast of the lead element. This method is easier to control and more secure than alternate bounding, but it is slower.

As an example, a three-vehicle section may use the vee formation with bounding overwatch (see [Figure 8-20](#)). The lead vehicles advance to a point (first move) where they can support the advance of the overwatch vehicle. On signal, the overwatch vehicle moves forward to a position abreast of the lead vehicles (second move) and halts. During its move, it is overwatched by both lead vehicles. The lead vehicles then move forward again, with the overwatch vehicle providing security. Maximum use is made of folds of the earth and concealment to mask movement from likely enemy positions.

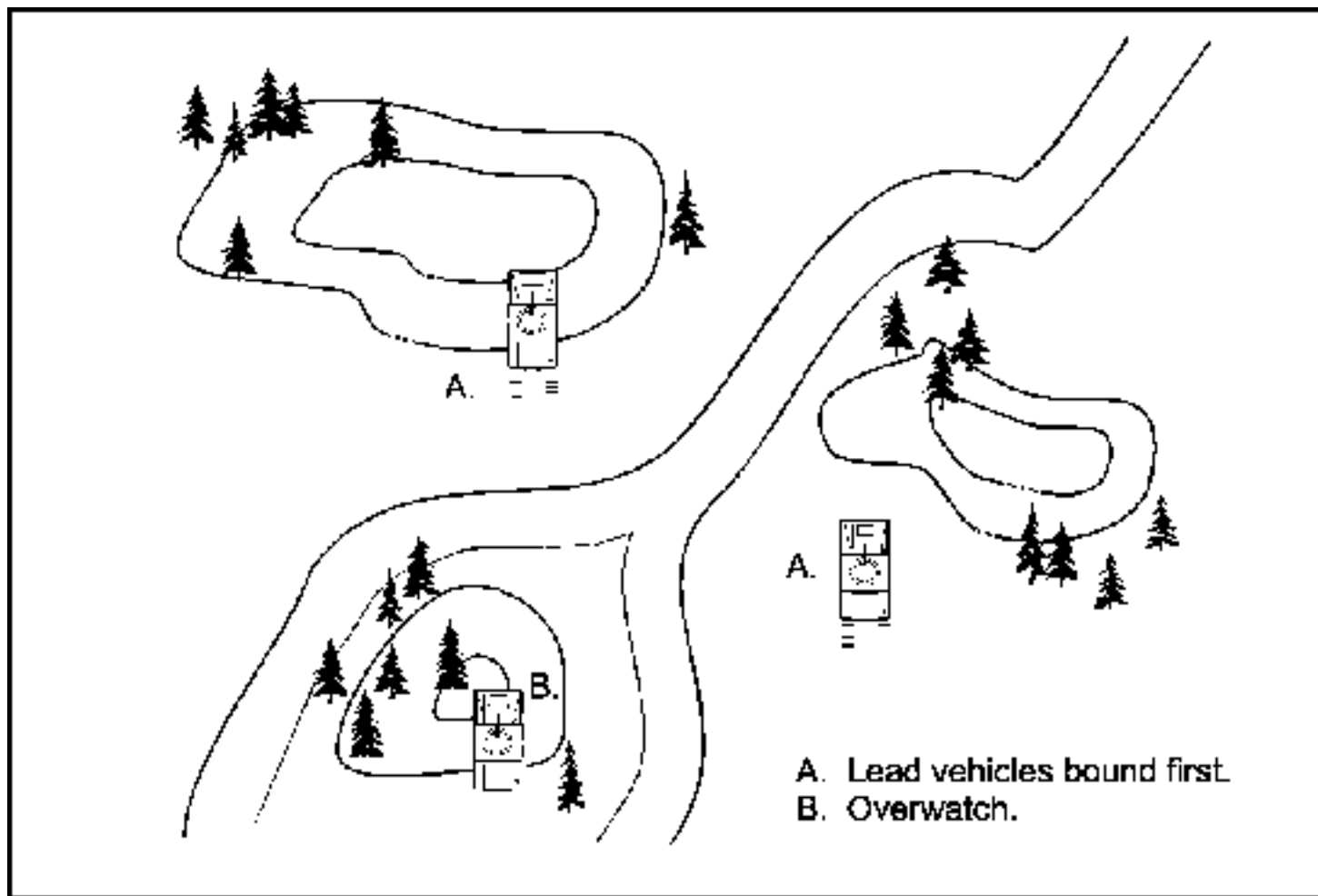

Figure 8-20. Section using bounding overwatch technique and vee formation.

MOVE-SET TECHNIQUE

This method of movement is simply an organized way of controlling the scout section when it moves in bounding overwatch. Set means that the element has arrived at its destination and has occupied a position from which it can observe to its front. This technique allows for an absolute minimum of radio transmissions, positive control by the section leader, and maximum security within the section. Preferably, the section leader uses hand-and-arm signals within the section for command and control. If the section leader must use the radio, squad leaders should keep their radios on the lowest possible power setting to reduce their signature and possible interference on the platoon net.

The move-set method can be used to control bounding overwatch within the scout section regardless of

the platoon organization. When terrain permits sections to be mutually supporting (such as in desert terrain) and other METT-TC factors are favorable, the platoon leader can use this technique to control bounding (by sections). In such a situation, the sections would not be operating independently, but rather would be directly controlled, and their movement coordinated, by the platoon leader.

SECTION 6 — FUNDAMENTALS OF MOVEMENT

Sound tactical movement is the essence of all scout platoon operations. Effectively employed, the guidelines in this section can help scouts to see the enemy first and observe him undetected. The scouts are then able to achieve a number of tactical goals: retain the initiative, bring indirect fire to bear on the enemy, help larger units to maneuver and destroy the enemy, and if necessary, use direct fire to kill the enemy.

USE TERRAIN FOR COVER AND CONCEALMENT

Terrain offers natural concealment from enemy observation and cover from enemy fire. Scouts must make maximum use of this natural protection to survive and accomplish their mission; avoiding enemy detection is the key. Cover should be used whenever possible. When no cover is available, however, scouts should use the concealment offered by trees, shadows, brush, and man-made structures (see [Figure 8-21](#)). The crest drills illustrated in [Figures 8-22](#) and [8-23](#) are examples of using the terrain to protect the vehicle from enemy observation during movement.



Figure 8-21. Use of natural concealment.

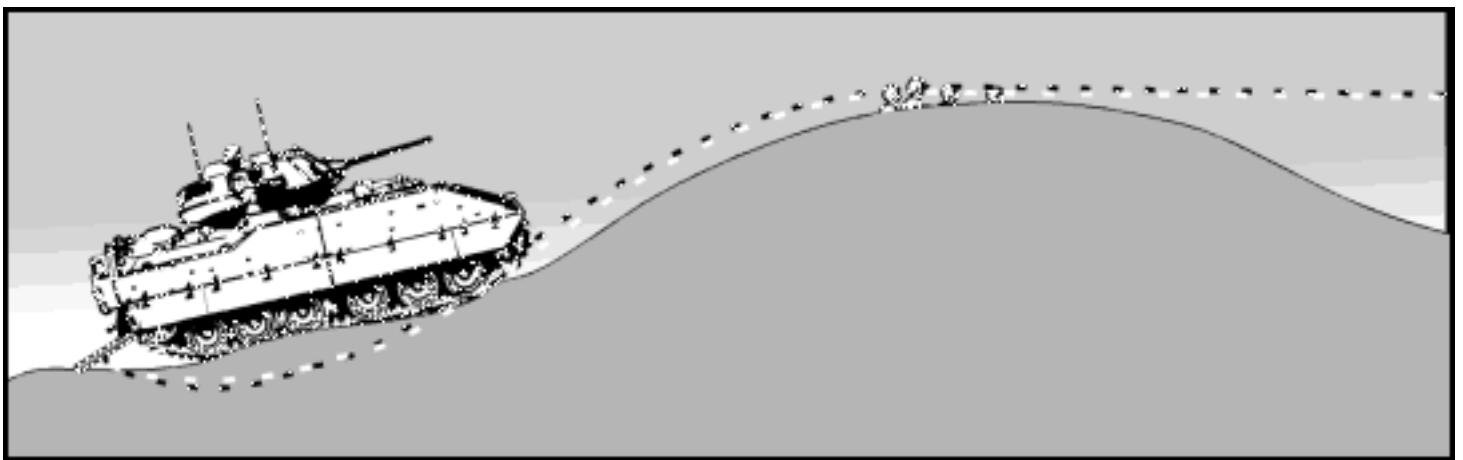

Figure 8-22. Dismounted crest drill.

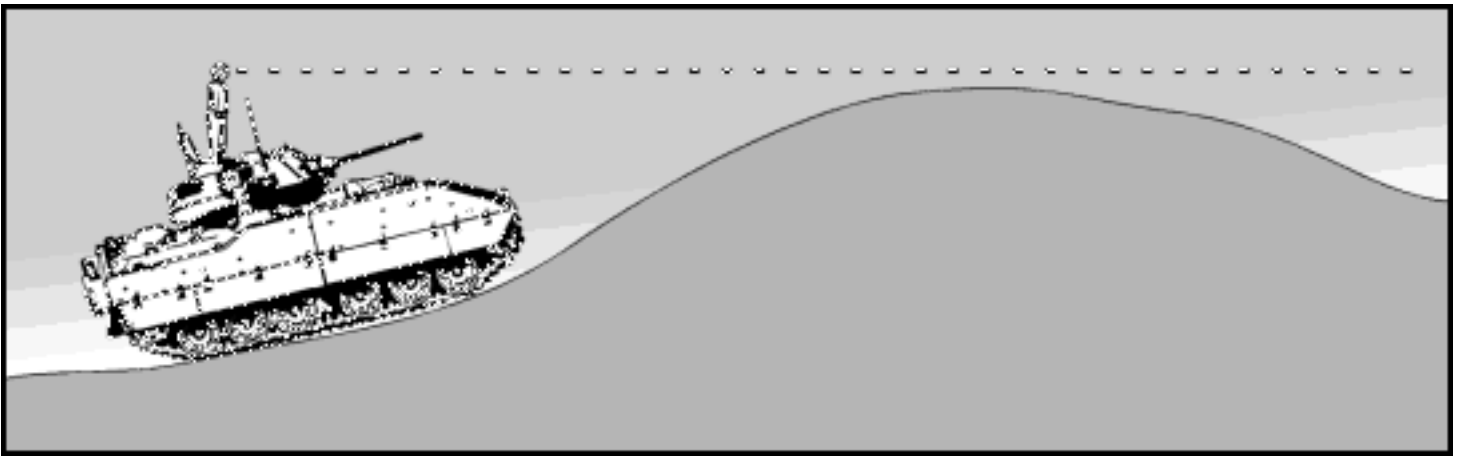

Figure 8-23. Mounted crest drill.

During mounted or dismounted movement, individual vehicles and personnel should avoid becoming silhouetted against a skyline. In addition, they should never move directly forward from a defilade position. Direct forward movement may enable the enemy to pinpoint the vehicle and engage it as it moves. Instead, vehicles should back up and move left or right around the previous position to get to the next position.

Despite its obvious advantage, movement along covered and concealed routes can present disadvantages that should be considered. Speed is often reduced, and control problems increase. The possibility of being ambushed by enemy infantry increases. In most situations, these limitations must be accepted because the accuracy and lethality of long-range weapons have made exposed movement too dangerous. The platoon leader must be careful to balance his need for security with his ability to conduct required observation and reconnaissance.

USE CAUTION AT DANGER AREAS

Scouts must be prepared to take necessary precautions when they encounter danger areas. Based on his own terrain analysis and the IPB products he has, the scout platoon leader must consider where enemy reconnaissance assets will be focused and determine their fields of observation. The platoon leader can then avoid movement through these areas. In addition, scouts should combine proper terrain driving techniques with carefully selected routes to maximize security.

The scout platoon should stop short of danger areas and use dismounted scouts to reconnoiter them. For example, when it encounters an open area, the platoon should send dismounts to a concealed position where they can observe the area. From that position, scouts should carefully check the other side of the open area for enemy positions. The scout must then cross the open area quickly, using overwatch and following the folds in the terrain. (**NOTE:** Refer to the discussion of danger areas in [Section 7](#) of this chapter.)

DISMOUNT VEHICLES

METT-TC factors require scouts to dismount to enhance survivability and mission accomplishment. Vehicles are easily identified because of their signatures; vehicles that can be seen can be killed. Conversely, dismounted patrols and OPs are very difficult to detect. Scouts should dismount their

vehicles and use binoculars whenever enemy contact is possible and vehicle movement is not necessary.

As an example, during reconnaissance operations forward of a main body, scouts should dismount beyond the direct-fire range of suspected enemy positions and weapon systems. Dismounted scouts can then precede their vehicles using the cover and concealment of a dismounted avenue adjacent to the mounted route. Additionally, dismounts can occupy dismounted OPs while leaving the vehicles in a hide or overwatch position. These basic actions enable the dismounted scouts to provide critical information to the commander while enhancing the unit's survivability and its ability to perform later missions.

REDUCE VEHICLE-RELATED SIGNATURES

The major signatures emitted by the scout platform (audible, thermal, visual) can be reduced. Audible signature can be reduced simply by shutting off the vehicle and related systems, such as heaters or thermal sights, whenever the vehicle is not moving or the system is not needed. The visual and thermal signatures can be reduced in numerous ways:

- Erect camouflage nets. This will help hide a stationary vehicle both visually and thermally; nets tied to the vehicle can reduce dust and exhaust signatures, as well as reduce the thermal signature while moving.
- Keep side skirts down on tracked vehicles to reduce the dust signature.
- Keep hatches closed to reduce noise and light signatures.
- Make careful precombat inspection of flashlights and dome lights to prevent white light displays at night.
- Reduce vehicle glass reflection from periscopes and windows by removing, covering, or camouflaging them (placing a net over the windshield, for example).

SECTION 7 — DANGER AREAS

During the execution of reconnaissance and security missions, scouts will encounter specific types of terrain or features that expose them to enemy fire. Known as danger areas, these are likely points of enemy contact due both to the scouts' vulnerability and to the cover, concealment, and observation these sites afford to the enemy. Danger areas should be identified and highlighted when the platoon leader performs his map reconnaissance during troop-leading procedures. Once these areas are identified, the scout can employ specific reconnaissance methods and movement techniques to move through them quickly and with maximum security.

OPEN AREAS

Open areas frequently afford the scout the opportunity to observe the enemy from long ranges. Conversely, they often require that the scout be exposed to possible enemy observation and fire for long periods of movement. Therefore, the platoon must make maximum use of the terrain and employ effective observation techniques to avoid exposing itself to a well-concealed and camouflaged enemy.

Before moving across a large open area, the scout platoon must make a thorough visual scan of the area. This should be done both dismounted and mounted, using all available optics. This scan focuses not only on finding potential enemy positions, but also on locating covered and concealed routes for bounding and

a covered and concealed position to which the unit can move. If time and terrain permit, dismounted scouts may be used to move to the far side of the open area and secure it. In very large open areas, use of dismounts may not be feasible because of the distances between covered and concealed positions.

Once the area has been cleared using visual means and/or dismounts, the scouts move across it. They use bounding overwatch because of the likelihood of enemy contact. If the open area is very large, the overwatch vehicle should only remain stationary until the bounding vehicle has moved a distance equal to half the effective range of the overwatching vehicle's weapon system. When that point is reached, the overwatch vehicle must move out, even if the bounding vehicle has not yet reached a position of cover and concealment.

When moving across large open areas with limited cover and concealment, the scouts should consider the use of reconnaissance by indirect or direct fire to provide additional security as they move. Additionally, indirect fire can provide concealment, with smoke either used alone or mixed with suppressive fires. However, using smoke is feasible only for limited periods because of Class V supply restrictions on supporting mortar or artillery units.

WOODED AREAS

Wooded areas provide a high degree of concealment to forces that occupy them, particularly infantry. They must be approached and moved through with extreme caution. Visibility within wooded areas is very limited; therefore, reconnaissance is confined primarily to trafficable routes and trails through the forest. In densely wooded areas, mounted scouts are extremely vulnerable to dismounted enemy forces that can close on them undetected.

Scouts should use available terrain to scan the wooded area before entering. They should search for movement, reflections, smoke, and any irregular shapes or colors indicating camouflage. Whenever possible, the entire wood line should be reconnoitered with dismounts prior to mounted movement to the wooded area.

The scouts should move mounted to the wooded area using bounding overwatch. Once the vehicles are set inside the wood line (approximately 100 to 200 meters), engines are shut off, dismounted security maintained, and a listening/security halt conducted. Crewmen who have CVCs remove them. Radio speakers are turned off. The halt should last approximately one to two minutes, with 360-degree security maintained throughout. These halts must be conducted at regular intervals while moving through the wooded area (approximately every kilometer).

During movement through a wooded area, scouts should move using traveling overwatch. This technique is appropriate because of the extremely short fields of view and the danger of dismounted ambush. Scout vehicles are most vulnerable in wooded areas when they are stopped, so halts should be kept to a minimum. Exposed scouts should maintain minimum silhouette in their vehicles because of the danger from close-in snipers and ambush.

Scouts may encounter small clearings, buildings, or hills while moving through a wooded area. Each must be treated as a separate task. Small clearings may require crossing in the same manner as a large open area. Isolated buildings must be checked by dismounted scouts. Hills and curves must be approached cautiously; any dead space must be cleared by dismounted scouts.

Before leaving a wooded area, scouts must clear the open area to the front. They stop inside the wood line (ensuring they are still within the shadow line of the woods). Engines are turned off, and dismounted scouts move to the edge of the wooded area to observe. If the area is determined to be clear, vehicles are brought forward to observation positions. As the dismounts remount, the vehicles use their optics to again visually clear the open area. Once this is completed, the scouts resume movement using their chosen movement technique.

BUILT-UP AREAS

Built-up areas, including towns and villages, pose many potential dangers for the scout platoon. Troops can be garrisoned in villages, snipers can dominate approaches, and buildings and roads can be mined and booby-trapped. Cover and concealment are abundant, and it is easy for the enemy to remain undetected until he is at very close range. Built-up areas are ideal for effective ambush by small numbers of infantry. Whenever possible, scouts should reconnoiter built-up areas from a distance and then bypass them. Detailed reconnaissance of built-up areas is beyond the capability of the scout platoon.

Sometimes, however, scouts may be required to execute a hasty reconnaissance of a town or village. They must always remember that this is a very dangerous task, especially if the enemy is occupying the built-up area in strength, and take steps to counter the dangers. Scouts should observe the town from a distance. They look for movement and evidence of enemy occupation, including track marks on pavement; lack of civilian activity; and sandbags, stakes, timber, intentional building damage, or any other sign of prepared fighting positions and obstacles.

The scouts should attempt to observe the area from multiple vantage points. If the area appears clear, scouts move through it using traveling overwatch, ensuring that vehicles remain in mutual support and maintain 360-degree security. A listening/security halt should be conducted just inside the edge of the built-up area and periodically thereafter.

Once in the town, all scouts must be alert to additional signs of enemy activity, including tactical markings or signaling devices, antennas, spent shell casings and pyrotechnics, and damage to buildings and streets. Dismounts can be used to clear major intersections and provide security during halts. The scouts do not have the manpower or time to clear buildings, but they can be employed dismounted for limited search and secure tasks as needed to support the movement of the mounted element or a particular reconnaissance mission. Vehicle-mounted crews must reduce their silhouette to a minimum when moving through a town.

As they approach the far side of the built-up area, the scouts should stop short and move dismounts to the edge of town. The dismounts will secure the local area and observe the open area beyond the town. When this has been completed, the vehicles will come forward and continue to observe from covered and concealed positions while the dismounted elements remount. The scouts are prepared to continue its mission.

LATERAL OR BOUNDARY ROUTES

As scouts execute reconnaissance and security missions, they will encounter routes or mobility corridors that provide access into the area between the scouts and friendly elements to their rear. These lateral corridors pose a security threat to both the scouts and the other friendly elements.

It is critical that the scouts maintain continuous surveillance of these mobility corridors to provide security against enemy forces that move into the sector after the scout platoon has moved on. This is especially important when the scouts are moving through an enemy security area where enemy forces are likely to move in response to friendly activity, when the scouts expect to encounter a moving enemy force, or in a meeting battle situation.

To maintain surveillance, the platoon can use outpostting to maximize the reconnaissance effort forward. This security technique involves the use of short-duration OPs consisting of two soldiers with equipment. A scout section or squad should deploy an outpost when it is at risk of losing observation on a possible enemy approach route that no other element can cover. Once deployed, the outpost maintains surveillance of the avenue of approach until the rest of the scout element returns. In doing so, the outpost can provide security through early warning of enemy activity that the mounted element would not have detected.

SECTION 8 — ACTIONS ON CONTACT

When scouts encounter enemy forces during a reconnaissance or security mission, they must quickly execute actions on contact. Whether they remain undetected or are identified by the enemy, the scouts must first take measures to protect themselves, find out what they are up against, and then decide on a COA. To properly execute actions on contact, scout must take action consistent with the following fundamentals of reconnaissance.

- Remain focused on the reconnaissance objective.
- Report quickly and accurately.
- Maintain contact with the enemy.
- Retain the freedom to maneuver.
- Develop the situation rapidly.

THE SEVEN FORMS OF CONTACT

In all types of operations, contact occurs when an individual soldier, squad, or section of the scout platoon encounters any situation that requires an active or passive response to the enemy. These situations may entail one or more of the following forms of contact:

- Visual contact (friendly elements may or may not be observed by the enemy).
- Physical contact (direct fire) with an enemy force.
- Indirect fire contact.
- Contact with obstacles of enemy or unknown origin.
- Contact with enemy or unknown aircraft.
- Situations involving NBC conditions.
- Situations involving electronic warfare tactics.

THE FOUR STEPS OF ACTIONS ON CONTACT

The commander should specify actions on contact for the scout platoon. These specific instructions should include engagement criteria and the desired COA, based on the size and activity of the enemy force encountered. By knowing these details ahead of time, the scout can develop the situation more rapidly and arrive at and execute the desired COA. The platoon should strive to make contact with the smallest possible element: the dismounted scout. Visual contact, in which the enemy is observed but the scout remains undetected, is the goal. This gives the platoon the greatest possible flexibility to maneuver and develop the situation.

The steps that make up actions on contact must be thoroughly trained and rehearsed so that the platoon can react instinctively as a team whenever it encounters enemy forces. The four steps, which are executed to allow the platoon to accomplish its mission in accordance with reconnaissance fundamentals, are the following:

- Deploy and report.
- Evaluate and develop the situation.
- Choose a COA.
- Execute a COA.

Step 1 - Deploy and report

When a scout makes contact with the enemy, he reacts according to the circumstances of the contact. (**NOTE:** Refer to the seven general categories of contact discussed earlier in this section.) The scout section or squad that makes initial visual contact with the enemy deploys to covered terrain that affords good observation and fields of fire. If the scouts receive fire from the enemy, they return fire.

The scout in contact sends a contact report (see [FKSM 17-98-3](#)) to the platoon leader and follows as soon as possible with a spot report using the SALUTE format (size, activity, location, unit identification, time, and equipment). If the scout in contact is unable to report or cannot report quickly, another squad in the section must report.

The scouts that are not in contact temporarily halt in covered terrain, monitor the incoming reports, and plot the situation on their maps. Once they determine that they cannot be influenced by the enemy in contact, they continue their mission with the platoon leader's approval. The platoon leader or PSG relays the contact report to the commander, followed as soon as possible by a spot report and updates.

Step 2 - Evaluate and develop the situation

The scouts next concentrate on defining what they are up against. If they have not sent a spot report to this point, they initially focus on getting enough information to send one. If they have not been detected by the enemy and time is available, the scouts reconnoiter the enemy position, emphasizing stealth and dismounted reconnaissance.

If the enemy is aware of their presence, the scouts use a combination of mounted and dismounted reconnaissance, as well as reconnaissance by fire. Dismounted reconnaissance will be conducted to get detailed information on enemy dispositions. Mounted reconnaissance will be used to move additional assets into the area to support the scout element in contact.

Indirect and direct fires are used to suppress the enemy while scouts maneuver to get information. The scouts attempt to confirm or determine in detail enemy size, composition, activity, orientation, and weapon system locations. They search for AT ditches, minefields, wire, or other obstacles that could force friendly forces into a fire sack. Scouts find the flanks of the enemy position and look for other enemy elements that could provide mutual support to the position. Once the scouts determine what they are up against, they update their spot report.

Step 3 - Choose a course of action

Once the element in contact has developed the situation and the platoon leader has enough information to make a decision, he selects a COA that is within the capabilities of the platoon, that allows the scouts to continue the reconnaissance as quickly as possible, and that supports the commander's concept of the operation. He considers various possible COAs, including the six discussed in the following paragraphs.

Disengage from enemy contact. The scout platoon cannot conduct its mission if it becomes decisively engaged by the enemy. Should the platoon become decisively engaged, it must have a plan on how to break contact with the enemy. As a general rule, the platoon, section, or squad should disengage from the enemy as early in the contact as possible. This will allow for continuation of the mission and reduce the chance of any loss of combat power.

At platoon level, OPs gain contact with the enemy main body, then report and prepare to displace to successive positions. The platoon members occupying the OPs should report the enemy contact to the overwatching vehicles and to the platoon leader, requesting permission to return to the vehicles. When permission has been granted, they use covered and concealed routes back to the vehicle positions and remount the vehicles.

When the enemy force reaches the OPs' break point (the point at which the OPs must displace or risk detection and/or engagement by the enemy), the OPs pass off responsibility for tracking the enemy to other OPs in depth. The platoon then displaces its OPs to successive positions in depth while maintaining contact with the enemy.

Once the initial contact has been reported to higher headquarters and the order to break contact has been given, disengagement should be executed with one section or squad acting as overwatch for the displacing section/squad as it moves. The section or squad that moves first will keep its weapon systems oriented on the enemy as it uses covered and concealed routes to move to a designated rally point that precludes enemy observation and provides cover and concealment. This element may also use on-board smoke generators or smoke grenades to cover its movement. The overwatching section/squad provides suppressive fires, both direct and indirect, to cover the movement of the displacing section/squad.

Once the displacing section/squad has arrived at the rally point, it takes up defensive positions and reports its arrival to the overwatch section/squad. The overwatching element then calls for protective fires and uses an alternate covered and concealed route to move to the rally point. When the entire platoon or section has moved back to the rally point, it consolidates and reorganizes, reports its status to the higher headquarters, and continues the mission. [Figure 8-24](#) illustrates a situation in which the scout platoon breaks contact by sections.

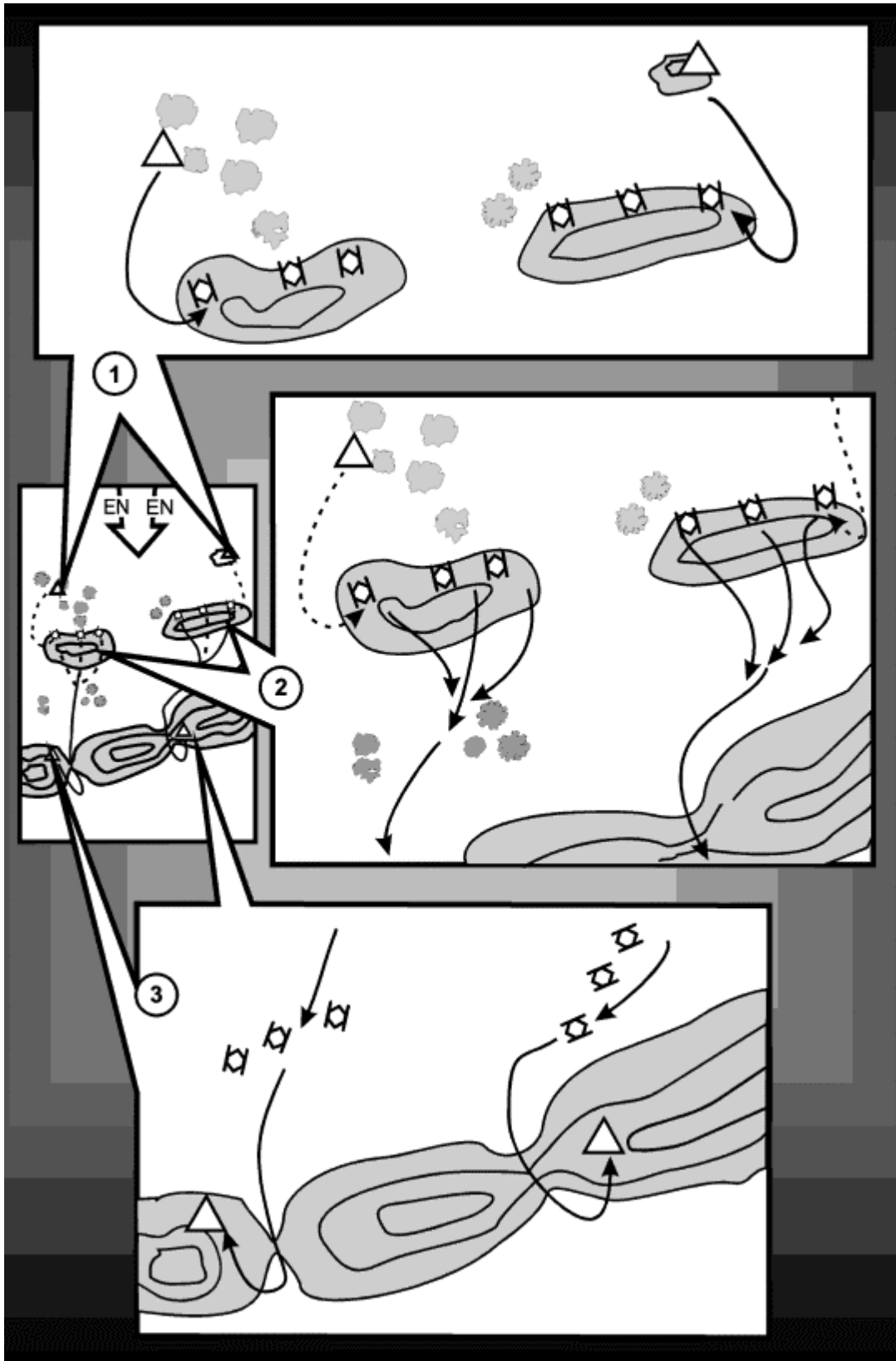

Figure 8-24. Platoon conducting disengagement by section.

Figure 8-24. Platoon conducting disengagement by section.

Break contact and bypass. This COA may be selected when the scout platoon does not have the resources to leave an element in contact and still continue to accomplish its priority reconnaissance tasks. It may also be selected when the platoon has made contact with an enemy force that cannot adversely affect the mission of the scouts' higher headquarters. Because breaking contact is a violation of reconnaissance fundamentals, the scout must be sure that his higher headquarters is informed of and approves this COA.

Maintain contact and bypass. This COA is appropriate when an enemy force, based on its current disposition, is not in a position to influence the scout's higher commander. An element (normally a section or squad) will be left to maintain contact while the rest of the platoon continues the reconnaissance mission. The element that remains in contact will maintain visual contact with the enemy and report if the enemy situation changes. The platoon must keep scouts in contact with the enemy unless specifically authorized to do otherwise.

Maintain contact to support a hasty attack. This COA is appropriate when the scouts discover enemy elements the higher commander wants to destroy, but which the scouts cannot destroy, either because they lack sufficient combat power or because they have other tasks to perform. In this situation, the scouts maintain contact by leaving a section or squad in contact. The rest of the platoon continues on to accomplish its other reconnaissance tasks while monitoring any changes in the enemy situation and supporting the hasty attack by a friendly unit.

The platoon focuses on requirements for a successful friendly attack, including the following:

- Locating covered and concealed movement routes for friendly attacking units.
- Locating attack positions.
- Establishing a contact point to link up with, brief, and guide the friendly unit as necessary.
- Designating an LD to use as a handoff line to the attacking unit.
- Preparing and coordinating fire support for the friendly attack.
- Locating and preparing to occupy base of fire positions, if required.

It is essential that the section or squad left in contact understand what needs to be accomplished, who will be executing the attack, and when the friendly unit anticipates being in position to receive handoff of the enemy. As the unit responsible for the attack moves into position, the scouts in contact may rejoin the platoon or be placed OPCON to the attacking unit to ease command, control, and coordination.

Conduct a hasty attack. In most cases, the scouts cannot, or should not, mass their combat power to defeat an enemy force. If the scouts concentrate, they risk losing the capability to complete their mission as well as jeopardizing their ability to conduct subsequent missions. If the scouts are permitted to attack an enemy, they should only attack lightly armored or unarmored reconnaissance vehicles, such as motorcycles or Soviet-style BRDMs and BTRs. They should avoid attacking more heavily armored vehicles except in self-defense.

Establish a hasty defense. The platoon will establish a hasty defense if it cannot bypass the enemy, all the sections and/or squads are fixed or suppressed, and the platoon no longer has the ability to move forward. A hasty defense will also be used when the enemy executes a hasty attack. The platoon maintains contact or fixes the enemy in place until additional combat power arrives or the platoon is ordered to move. If the scout platoon is required to conduct a hasty defense, the commander then becomes responsible for continuing to develop the situation.

Step 4 - Execute a course of action

The platoon leader updates his spot report to the commander with any new information and then recommends a COA to the commander. The commander approves or disapproves the recommended COA based on how it will affect the parent unit's mission.

If the commander and the S2 have anticipated the enemy situation the scout platoon is reporting, they will already have addressed the contingency in the OPORD and given guidance to their subordinates on what COA the scout platoon should execute. In such a case, the scout platoon leader can evaluate the situation, choose a COA consistent with his higher commander's intent or concept, and execute it without further guidance. He keeps the commander informed of what he is doing as he executes the COA.

EXAMPLES OF ACTIONS ON CONTACT

The following examples illustrate actions on contact in a variety of tactical situations. They are organized using the four-step process.

Actions on contact with an unknown or superior force

Deploy and report. The scouts make contact as the lead scout vehicle is engaged. The lead scout and the overwatch see the signature of the enemy weapon system; since they do not have a clear idea of the size of the enemy, they react as if it were a superior force. Simultaneously, the lead scout returns fire, sends a contact report, pops smoke grenades, and moves to the nearest hide position. The overwatch vehicle also engages the source of enemy fire and monitors to ensure the contact report is sent. As soon as the lead vehicle is in a covered and concealed position, the overwatch vehicle moves to an alternate firing position and occupies a hide position.

As soon as they reach cover and concealment, both vehicles send out dismounted elements, which quickly establish a hasty OP to regain or maintain contact with the source of enemy fire. The scout leader follows up on the contact report with an initial spot report. This initial report may not be very detailed, but it will include a description of what happened and the approximate location of the enemy.

Evaluate and develop the situation. Once the scout section or squad is set in cover and concealment and has submitted its initial reports, it must develop the situation. The objective is to determine exactly what the enemy situation is by dismounted reconnaissance. This can best be done by moving to the enemy's flank or rear. The section/squad leader organizes a hasty reconnaissance patrol that will attempt to move to the flank or rear of the enemy and observe the enemy position. Simultaneously, the section or squad maintains at least one hasty OP in contact with the enemy. As the dismounted element maneuvers, it is supported by direct fire from the scout vehicles, by indirect fire called for by the OP, or by both. These fires serve to suppress the enemy, reducing his ability to observe the scouts; they also fix the enemy's

attention on the last known location of the mounted element.

In the course of attempting to develop the situation, the section or squad may determine that it is unable to determine the exact enemy situation for a number of possible reasons: suppressive fires by the enemy; obstacles; combat losses; or the size and extent of the enemy position. This information is sent to the platoon leader as soon as possible in the form of updates to the original spot report.

If this occurs, the platoon leader must decide whether to commit additional platoon assets to the contact to develop it further or to adopt a COA based on the information he has discovered to that point. If the platoon leader determines he needs more information, he must commit additional assets (scout sections or squads) to develop the situation further. The earlier in the contact that the platoon leader can make this decision the better; however, he must not commit unneeded resources to an action that will detract from other reconnaissance tasks.

If he decides additional assets are required, the platoon leader then orders other sections or squads not in contact to move to specific locations and assist in developing the situation. As more than one section or squad becomes involved in the situation, the platoon leader or PSG (whoever is in the best location to do so) takes control of coordinating their efforts. The elements conduct mounted movement to designated dismount points, where they organize dismounted patrols to develop the situation from a new direction. As these patrols discover the enemy and add additional information to the platoon leader's picture, the platoon leader may determine he has sufficient information to choose and execute a COA or to make a recommendation to his commander.

Choose a course of action. Based on the available information and his commander's intent and guidance, the platoon leader determines to leave one section in contact to support a hasty attack by a supporting tank platoon. His other sections continue their reconnaissance mission.

Execute a course of action. In this example, because the commander had specifically addressed the contingency the scout platoon has developed, the platoon leader neither makes a recommendation to his commander nor asks his permission to execute the COA. Instead, the platoon leader immediately issues orders to his sections and contacts the tank platoon leader to initiate coordination for handover of the enemy and support of the tank platoon's hasty attack. He keeps the commander informed of his actions.

Actions on contact with an inferior force

Deploy and report. The lead scout element (section or squad) identifies an enemy element, which consists of one reconnaissance vehicle. In the commander's order, the section or squad was tasked to destroy all wheeled reconnaissance patrols. The section/squad leader sends a contact report and quickly engages and destroys the enemy vehicle. After the engagement is complete, he sends an initial spot report.

Evaluate and develop the situation. Both the lead vehicle and the overwatch element occupy positions that allow them to observe the destroyed vehicle. They look for any other signs of enemy activity or any enemy response to the destruction of the vehicle. The lead vehicle then bounds past the destroyed vehicle and establishes far-side security. Once far-side security is established, a dismounted element moves to the destroyed vehicle and conducts a thorough search for prisoners, items of intelligence value, and any other information that can be gained from a close examination of the enemy. When this reconnaissance is complete, the section or squad sends an updated report to higher headquarters.

Choose a course of action. When engagement is complete and the enemy is destroyed, the COA is obvious: the section or squad will continue its mission.

Execute a course of action. Since the destruction of the enemy is in accordance with the commander's order, the section/squad leader simply informs higher headquarters that he is continuing the mission.

Actions on visual contact (undetected contact)

Deploy and report. A scout section or squad makes contact when its dismounted element identifies an enemy force. It immediately sends a contact report informing higher headquarters that it has made visual contact with the enemy but is not being engaged. This report is quickly followed by an initial spot report.

Evaluate and develop the situation. Based on the initial spot report of the scout section or squad in contact, the platoon leader determines that he has located his primary reconnaissance objective; he orders additional sections or squads to maneuver into the area. These scout elements move to dismount points, set their vehicles in hide positions, and send dismounted patrols from different directions into the area of contact.

The patrols move to multiple vantage points using dismounted reconnaissance techniques, with the emphasis on avoiding detection. They send spot reports to the platoon leader with new information as it is determined. The platoon leader moves his element to a covered and concealed hide position where he can maintain effective communications with both subordinate elements and higher headquarters. From this position, he establishes local security (a hasty OP) and monitors and controls the efforts of his sections or squads.

Choose a course of action. When the platoon leader receives sufficient reports to have a clear picture of the situation, he chooses to prepare to support a hasty attack. This choice is made because the platoon leader determines that the force he has located is the objective of his commander; therefore, this COA is in accordance with his commander's intent.

Execute a course of action. The platoon leader issues appropriate orders directing his subordinates to prepare to support the hasty attack. He continues to inform his commander of the enemy situation and the platoon's actions.

SECTION 9 — CALL FOR FIRE

To ensure they and their parent unit receive the full benefit of indirect fire support during tactical operations, scouts must know how to call for and adjust these fires effectively. Refer to [FM 6-30](#) for additional information on the call for fire process. The discussion of indirect fire support in [Chapter 6](#) of this manual covers related subjects, including mortar and FA assets, fire direction assets, fire request channels, and fire planning procedures.

INITIAL CALL FOR FIRE

The standard call for fire consists of three basic transmissions, consisting of six elements as follows:

- Observer identification and warning order (first transmission).
- Target location (second transmission).

- Description of target, method of engagement, and method of fire and control (third transmission).

Observer identification and warning order

The observer identification tells the FDC who is calling. It also clears the net for the rest of the call. The warning order tells the FDC the type of fire support mission and the method of locating the target. The types of missions are the following:

- **Adjust fire.** This is used when the observer is uncertain of the exact target location. The observer says, "ADJUST FIRE."
- **Fire for effect.** The observer should always try first-round fire for effect if he is sure that his target location is correct. He should also be sure that the rounds of the first volley will have the desired effect on the target so that little or no adjustment will be required. The observer says, "FIRE FOR EFFECT."
- **Suppression.** The word "SUPPRESS" is used to quickly bring fire on a preplanned target only. This is a simplified call for fire and is sent in one transmission. Example: "G24--THIS IS G59--SUPPRESS AF2401--OVER." Target description is not announced.
- **Immediate suppression.** This is used to bring fire quickly on a planned target or a target of opportunity that is firing at a friendly unit or aircraft. Example: "G24--THIS IS G57--IMMEDIATE SUPPRESSION AF2402--OVER." Target description is not announced.

Target location

Following the type of mission, the method of target location is announced; this prepares the FDC to receive the data sent by the observer and apply it to locate the target. The three methods for locating targets are grid, polar plot, and shift from a known point. Only the polar plot and shift methods are initially announced to the FDC. If the observer does not specify either polar or shift, the FDC knows the grid method is being used; the word "grid" is not announced in the initial transmission. Example: "H24--THIS IS H67--FIRE FOR EFFECT--POLAR--OVER." (**NOTE:** The word "grid" is announced at the beginning of a subsequent transmission calling for an adjustment of fires. Example: "H24--THIS IS H67--ADJUST FIRE GRID 123445--OVER.")

Grid method. When using the grid method, the target location is normally sent in six digits (example: "180739"). The direction from the observer to the target (in mils, if possible) must be given to the FDC after the call for fire, but before the first adjusting rounds are shot.

Polar plot method. This method requires that the observer and the FDC know the observer's exact location. The observer determines the direction (to the nearest 10 mils) of the observer-target (OT) line and the distance (to the nearest 100 meters) from his position to the target.

Shift from a known point method. This method can be used if the observer and the FDC have a common known point. This point must have been previously established as an artillery target. To locate the target, the observer must first determine the direction to the nearest 10 mils. If the observer has no compass, he can determine the direction by using a map and protractor or by using his binocular reticle pattern and a known direction to the known point. He should remember to apply the RALS rule (right add, left subtract) in determining direction to the target.

The observer then determines the lateral and range shifts. Lateral shifts are left or right from the known point to the OT line and are given to the nearest 10 meters. Range shifts are given as "ADD" (when the

target is beyond the known point) or "DROP" (when the target is closer than the known point). Range shifts are given to the nearest 100 meters. [FM 6-30](#) explains in detail how to determine the lateral and range shifts.

Description of target, method of engagement, and method of fire and control

The observer includes these elements in his call for fire using the guidelines discussed in the following paragraphs.

Description of target. The observer describes the target to the FDC. The FDC then determines the type and amount of ammunition needed. The target description should be brief yet accurate. This is the last required element in the call for fire.

Method of engagement. The observer specifies how he wants to attack the target (type of ammunition, fuze, distance from friendly troops). The FDC may change the ammunition type and/or fuze based on ammunition constraints. If the target is within 600 meters of friendly troops, the observer announces "DANGER CLOSE" to supporting mortars and artillery. When "DANGER CLOSE" is called, the initial rounds in adjustment should use a delay fuze.

Method of fire and control. The observer states who will give the command for fire to begin. If the observer wants to control the time of firing, he will say, "AT MY COMMAND." The FDC will tell the observer when the unit is ready to fire. At the proper time, the observer will say, "FIRE." If the observer does not say, "AT MY COMMAND," the FDC will fire as soon as the platoon/battery is ready.

ADJUSTING INDIRECT FIRE

Once the call for fire has been made, the observer's next concern is to ensure that the fire hits the target. If he can locate the target accurately, he will request fire for effect in his call for fire. When the observer cannot accurately locate the target for any reason (such as deceptive terrain, lack of identifiable terrain features, poor visibility, or an inaccurate map), he must conduct an adjustment to get the fire on target. Normally, one artillery piece or mortar is used in adjustment.

The observer must first pick an adjusting point. For a destruction mission (precision fire), the target is the adjusting point. For an area target (area fire), the observer must pick a well-defined adjusting point at the center of the area or close to it. The observer must spot the first adjusting round and each successive round and send range and deviation corrections, as required, back to the FDC until fire hits the target. The observer spots by relating the burst or group of bursts to the adjusting point. For a further discussion of adjusting mortar and artillery fire, see [FM 6-30](#).

Deviation spotting

As applied to deviation (left or right), spotting involves measuring the horizontal angle (in mils) between the burst and the adjusting point. An angle-measuring device or technique, such as the mil scale on the reticle of military binoculars or the hand-and-fingers method, is required to determine deviation.

A burst to the right (or left) of the target is spotted as "(number) MILS RIGHT (LEFT)." A burst on the OT line is spotted as "LINE." Deviation to the left or right should be measured to the nearest 5 mils for area targets, with measurements taken from the center of the burst. Deviation for a destruction mission (precision fire) is estimated to the nearest mil.

Deviation correction

Once the mil deviation has been determined, the observer must convert it into a deviation correction (in meters). Deviation correction is the distance in meters the burst must be moved to be on line between observer and target. It is sent, with the range correction, to the FDC for the next adjusting round or when calling for fire for effect.

Deviation correction is determined by multiplying the observed deviation in mils by the distance from the observer to the target in thousands of meters. This distance is expressed as the OT factor (see [Figure 8-25](#)). The correction is expressed to the nearest 10 meters (see [Figure 8-26](#)).

GUIDE FOR DETERMINING THE OT FACTOR	<p>OT distance greater than 1,000 meters. Round to the nearest thousand, and express in thousands of meters.</p> <hr/> <p>EXAMPLES:</p> <p style="padding-left: 40px;">OT distance, 4,200 meters- OT factor, 4.0</p> <p style="padding-left: 40px;">OT distance, 2,700 meters- OT factor, 3.0</p>
	<p>OT distance less than 1,000 meters. Round to the nearest 100 meters and express in thousands of meters.</p> <hr/> <p>EXAMPLES:</p> <p style="padding-left: 40px;">OT distance, 800 meters- OT factor, 0.8</p>

Figure 8-25. Determining the OT factor.

EXAMPLE:

Observed deviation 20 mils

OT distance 2,000 meters

OT factor 2

Observed deviation X OT factor = Deviation correction
20 X 2 = 40 meters

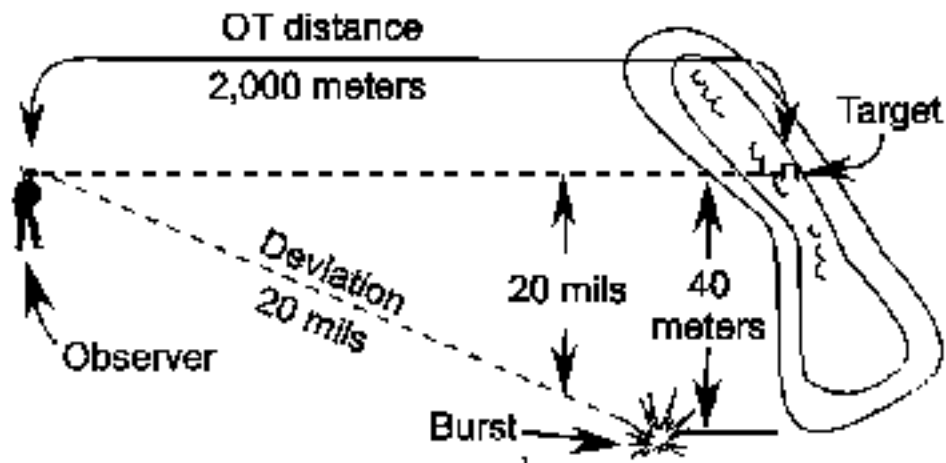

Figure 8-26. Converting mil deviation to deviation correction.

Minor deviation corrections (10 to 20 meters) are necessary in adjustment of precision fire. In adjustment of area fire, however, small deviation corrections (20 meters or less) should be ignored except when such a small change is necessary to determine a definite range spotting. Throughout the adjustment, the observer should move the adjusting rounds close enough to the OT line so that range spotting can be made accurately.

Range spotting

As applied to range (short or over), spotting is required to make adjustments to place fire on the target. Transmissions for range spotting use the following terminology:

- **"OVER."** This term is used for a burst that appears to strike beyond the adjusting point.
- **"SHORT."** This is used for a burst that appears to strike between the observer and the adjusting point.
- **"TARGET."** This spotting term describes a burst that hits the target; it is used only in precision fire (destruction missions).
- **"RANGE CORRECT."** This is used for a burst that appears to be at the correct range.
- **"DOUBTFUL."** This is used for a burst that can be observed but cannot be spotted in one of the previous categories (over, short, target, or range correct).
- **"LOST."** This describes a burst whose location cannot be determined.

- **"LOST OVER" or "LOST SHORT."** These terms are used for a burst that is not observed but that is definitely known to be beyond or short of the adjusting point.

Any range spotting other than "DOUBTFUL" or "LOST" is definite. Usually, an adjusting round's burst that is on or near the OT line will give a definite range spotting. The observer can make a definite range spotting even when the burst is not on or near the OT line. He uses his knowledge of the terrain or wind and observes debris scattered by the explosion. However, if the observer is not sure ("DOUBTFUL"), the correction he sends to the FDC should be for deviation ("LEFT" or "RIGHT") only. This is done to bring the burst on line to get a definite range spotting ("OVER, " "SHORT, " or "TARGET").

Range correction

Bracketing. The observer gives range corrections so that, with each successive correction, the adjusting round intentionally lands over or short of the adjusting point, closing on the target. Fire for effect is called for when a range correction would bring the next round within 50 meters of the adjusting point. This technique is called bracketing (see [Figure 8-27](#)).

Bracketing is a safe technique in that it is sure to bring fire on the target. Time is important, especially when targets are moving or may move to seek cover when they find fire coming their way. Accurate initial location information speeds adjustment and makes the requested fire more effective. To shorten adjustment time, the observer should try to bracket the target quickly (in the first two or three adjusting rounds), then try to adjust on the target with as few subsequent rounds as possible.

Hasty bracketing. Experience has shown that effectiveness on the target decreases as the number of rounds used in adjustment increases. An alternative to successive bracketing is hasty bracketing. While successive bracketing mathematically ensures that the fire-for-effect rounds will strike within 50 meters of the adjusting point, it is a slow and unresponsive technique. Therefore, if the nature of the target dictates that effective fires are needed faster than successive bracketing can provide them, hasty bracketing should be used.

The success of hasty bracketing depends on a thorough terrain analysis that gives the observer an accurate initial target location. The observer obtains a bracket on his first correction in a manner similar to that used for successive bracketing. Once the observer has this initial bracket, he uses it as a yardstick to determine his subsequent correction. He then sends the FDC the correction to move the rounds to the target and fire for effect. Hasty bracketing improves as the observer gains experience and judgment. Every observer must strive to improve his abilities and increase his responsiveness on the battlefield.

Creeping. The creeping method of adjustment is used in "DANGER CLOSE" situations. Here, the initial round is fired beyond the target. Adjusting rounds are brought in 100 meters or less until the target is engaged. This method is slow and tends to use more ammunition than other adjustments; therefore, it should be used only when soldier safety is a major concern.

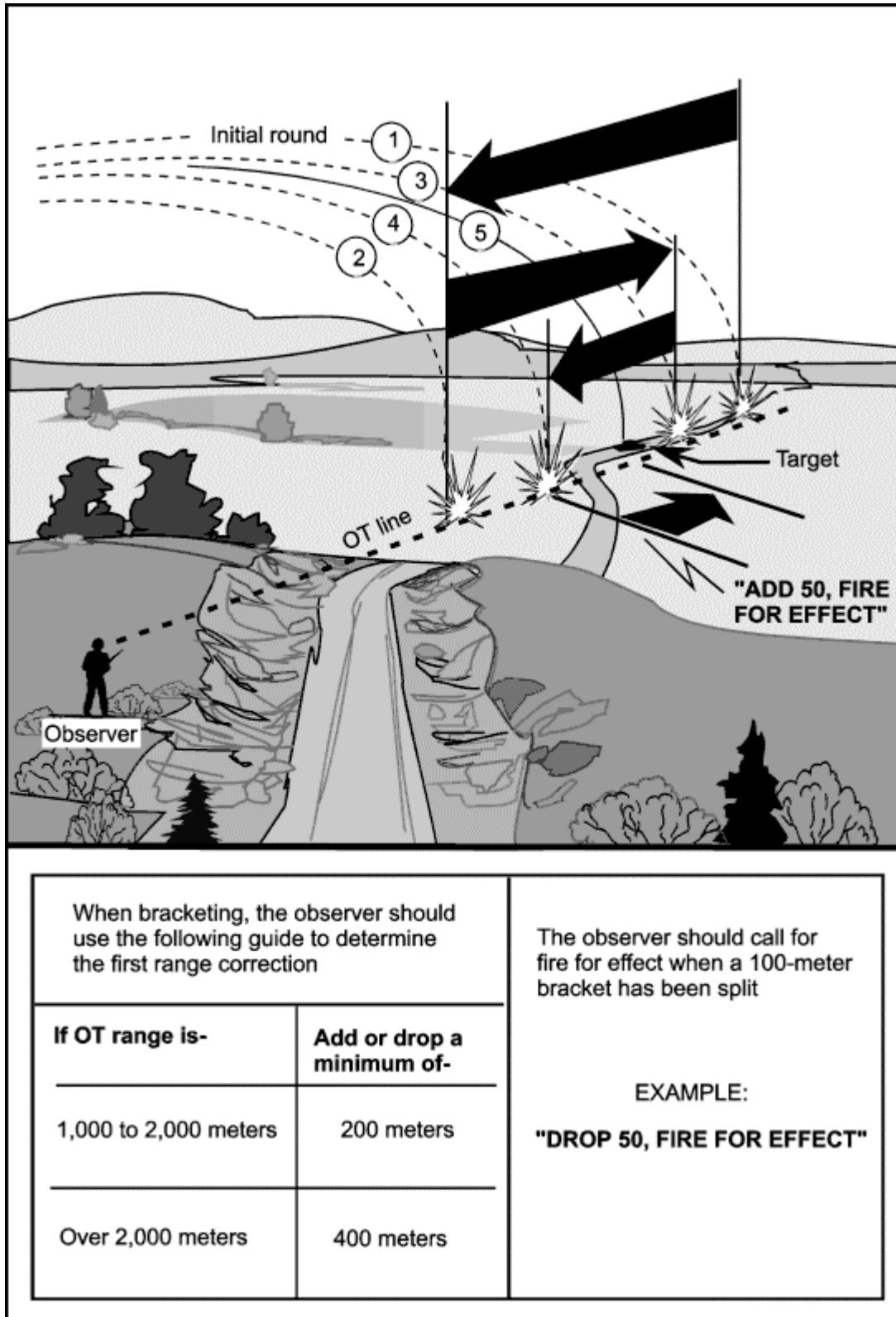

Figure 8-27. Bracketing

REFINEMENT AND SURVEILLANCE

The observer should note the results of the fire for effect and then take whatever action is necessary to complete the mission. [Figure 8-28](#) shows the observer's actions after the fire-for-effect rounds have been fired.

RESULTS OF FIRE FOR EFFECT	OBSERVER'S ACTIONS (Radio transmissions in parenthesis)
Accurate and sufficient	End of mission, surveillance ("END OF MISSION, RPG SILENCED, OVER")
Accurate, sufficient, target replot desired	Request replot, end of mission, surveillance ("RECORD AS TARGET, END OF MISSION, BMP NEUTRALIZED, OVER")
Inaccurate and sufficient	Refinement, end of mission, surveillance ("RIGHT 20, ADD 20, END OF MISSION, RPG SILENCED, OVER")
Inaccurate, sufficient, target replot desired	Refinement, request replot, end of mission, surveillance ("RIGHT 10, RECORD AS TARGET, END OF MISSION, BMP NEUTRALIZED, OVER")
Inaccurate and Insufficient	Refinement, repeat and reenter, adjust fire ("RIGHT 10, ADD 50, REPEAT," or "RIGHT 10, ADD 100, ADJUST FIRE, OVER")
Accurate and insufficient	Repeat ("REPEAT, OVER")

Figure 8-28. Observer's actions after fire for effect.

CHAPTER 9

Miscellaneous Field Data

This chapter includes information that may prove useful to the scout platoon's leaders and crewmen during the execution of platoon missions. This material is not covered elsewhere in this manual; some portions were taken from previously published sources, including FM 17-98-1, now rescinded.

CONTENTS

<u>Section 1</u>	<u>Reconnaissance Overlay Symbols</u>
<u>Section 2</u>	<u>Field Expedient Formulas</u>
<u>Section 3</u>	<u>Measurement Conversions</u>
<u>Section 4</u>	<u>Field Expedient Antennas</u>
<u>Section 5</u>	<u>Survival</u>
<u>Section 6</u>	<u>Enemy Weapons, Vehicles, and Aircraft</u>

SECTION 1 — RECONNAISSANCE OVERLAY SYMBOLS

[Figure 9-1](#) outlines a variety of symbols that scouts can use to illustrate reconnaissance data on their overlays. An example of how these graphics are used in the overlay is illustrated in [Figure 9-2](#). [Figure 9-3](#) shows symbols for various materials, facilities, equipment, and services. The graphics in this section are adapted from information provided in [FM 5-170](#).

Symbols for use in the reconnaissance overlay	
Symbol	Description and criteria
<p>BYPASSES</p> 	<p>BYPASSES: Are local alternate routes which enable traffic to avoid an obstruction. Bypasses are classified as EASY, DIFFICULT or IMPOSSIBLE. Each type bypass is represented symbolically on the line extending from the symbol to the main location and defined as follows:</p> <p>BYPASS EASY: The obstacle can be crossed within the immediate vicinity by a US 5 ton truck (or NATO equivalent) without work to improve the bypass.</p> <p>BYPASS DIFFICULT: The obstacle can be crossed within the immediate vicinity, but some work will be necessary to prepare the bypass.</p> <p>BYPASS IMPOSSIBLE: The obstacle can only be crossed by one of the following methods:</p> <ol style="list-style-type: none"> (1) Repair of item, i.e. bridge. (2) New construction. (3) Detour using an alternate route which crosses the obstacle some distance away.
<p>STEEP GRADES</p> 	<p>STEEP GRADES: (An obstruction.) Any grade 7% or higher. Actual % of grade will be shown. Arrows always point uphill, and length of arrow represents length of grade if map scale permits. (The percent of slope is written to the right of the arrow.)</p>
<p>OBSTACLES</p> 	<p>OBSTACLES: Are natural or man-made restrictions which impede the flow of traffic along a designated route.</p>

Figure 9-1. Reconnaissance overlay symbols.



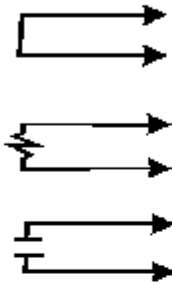
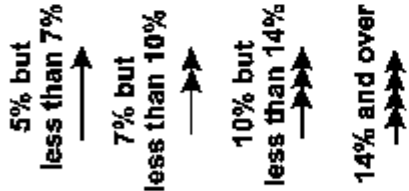
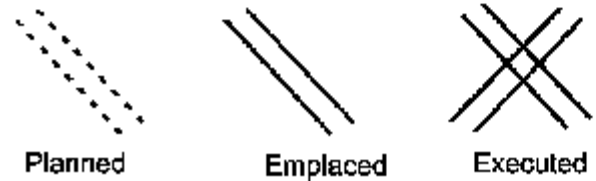

Symbols for use in the reconnaissance overlay	
Symbol	Description and criteria
<p>SINGLE CURVE</p> 	<p>SHARP CURVE: Any curve with a radius of 25 meters or less is an obstruction. All curves with a radius less than 45 meters are reportable.</p>
<p>MULTIPLE CURVES</p> 	<p>SERIES OF SHARP CURVES: The figure to the left indicates the number of curves; that to the right, the minimum radius of curvature in meters.</p>
<p>CRITICAL POINT</p>  <p>Number critical points in order and describe them on DA Form 1711-R.</p>	<p>CRITICAL POINT: A key geographic point or position important to the success of an operation; a point in time, a crisis or turning point, or any point along a route of march where interference with troop movement may occur.</p>
<p>CONSTRICTION</p> 	<p>CONSTRICTION: (An obstruction.) Any reduction in the traveled way below the minimum required. The figure to the left indicates the width of the constriction; that to the right, the total constricted length, both in meters.</p>
<p>UNDERPASS</p>  <p>UNDERPASSES: Show shape of structure (obstruction) when overhead clearance is less than 4.3 meters.</p>	
<p>ROUTE DESIGNATION</p> 	<p>ROUTE DESIGNATION: Civil or military route designation. Written in parentheses along route.</p>

Figure 9-1. Reconnaissance overlay symbols (continued).

Symbols for use in the reconnaissance overlay	
Symbol	Description and criteria
<p>BRIDGE Full NATO Bridge Symbol</p> <p>When full NATO bridge symbol is used on an overlay, the additional information column on the DA Form 1249 will not contain bypass length, traveled way width, or overhead clearance.</p>	
<p>BRIDGE Abbreviated Bridge Symbol</p> <p>When abbreviated symbol is used, DA Form 1249 must be attached.</p>	
<p>TUNNEL</p> <p>TUNNEL: (Includes man-made snow sheds.) Show the shape of structure or obstruction when overhead clearance is less than 4.3 m.</p>	

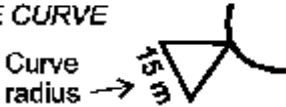
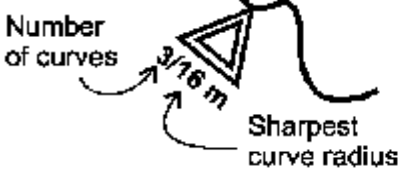
Figure 9-1. Reconnaissance overlay symbols (continued).

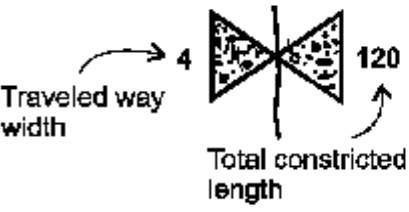
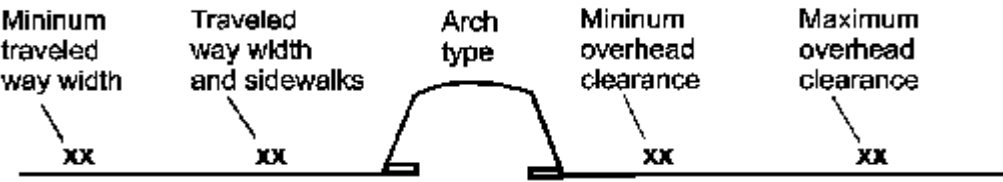
Symbols for use in the reconnaissance overlay	
Symbol	Description and criteria
<p>FORD</p> <p>FORD: All fords are considered as obstructions to traffic.</p> <p>Type of ford: V- Vehicular P- Pedestrian</p> <p>Seasonal limiting factors: X-- No seasonal limitation except for limited duration sudden flooding. Y-- Significant seasonal limitations.</p> <p>Approach conditions: Difficult Easy</p> <p>Nature of bottom: M-- Mud C-- Clay S-- Sand G-- Gravel R-- rock P-- Artificial paving</p>	
<p>FERRY</p> <p>FERRY: All ferries are considered as obstructions to traffic.</p> <p>Type of ferry: V- Vehicular P- Pedestrian</p> <p>Approach conditions: Difficult Easy</p>	
	<p>LIMITS OF SECTOR: Limits of reconnoitered sector or of route having some road classification formula.</p>

Figure 9-1. Reconnaissance overlay symbols (continued).

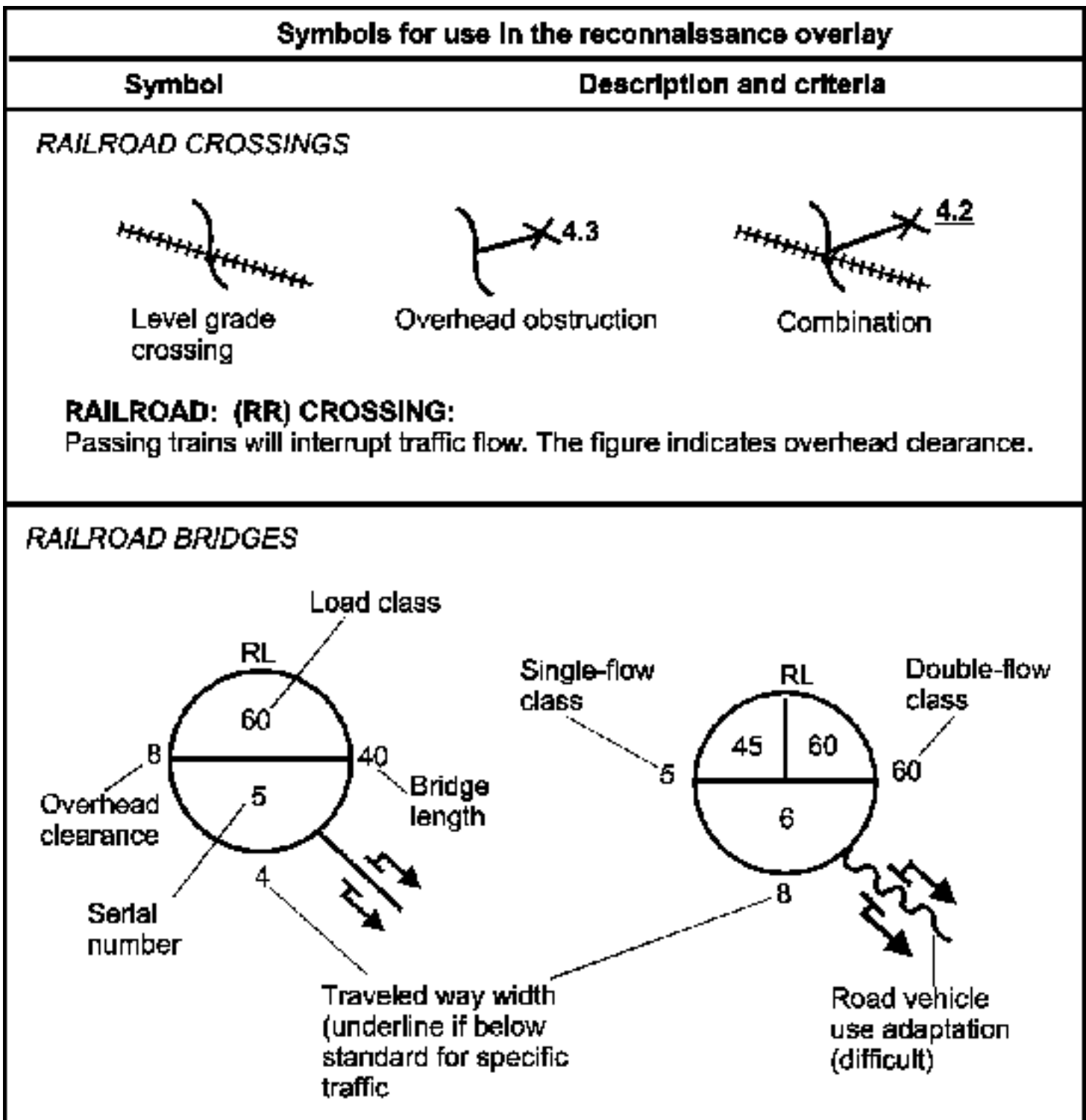

Figure 9-1. Reconnaissance overlay symbols (continued).

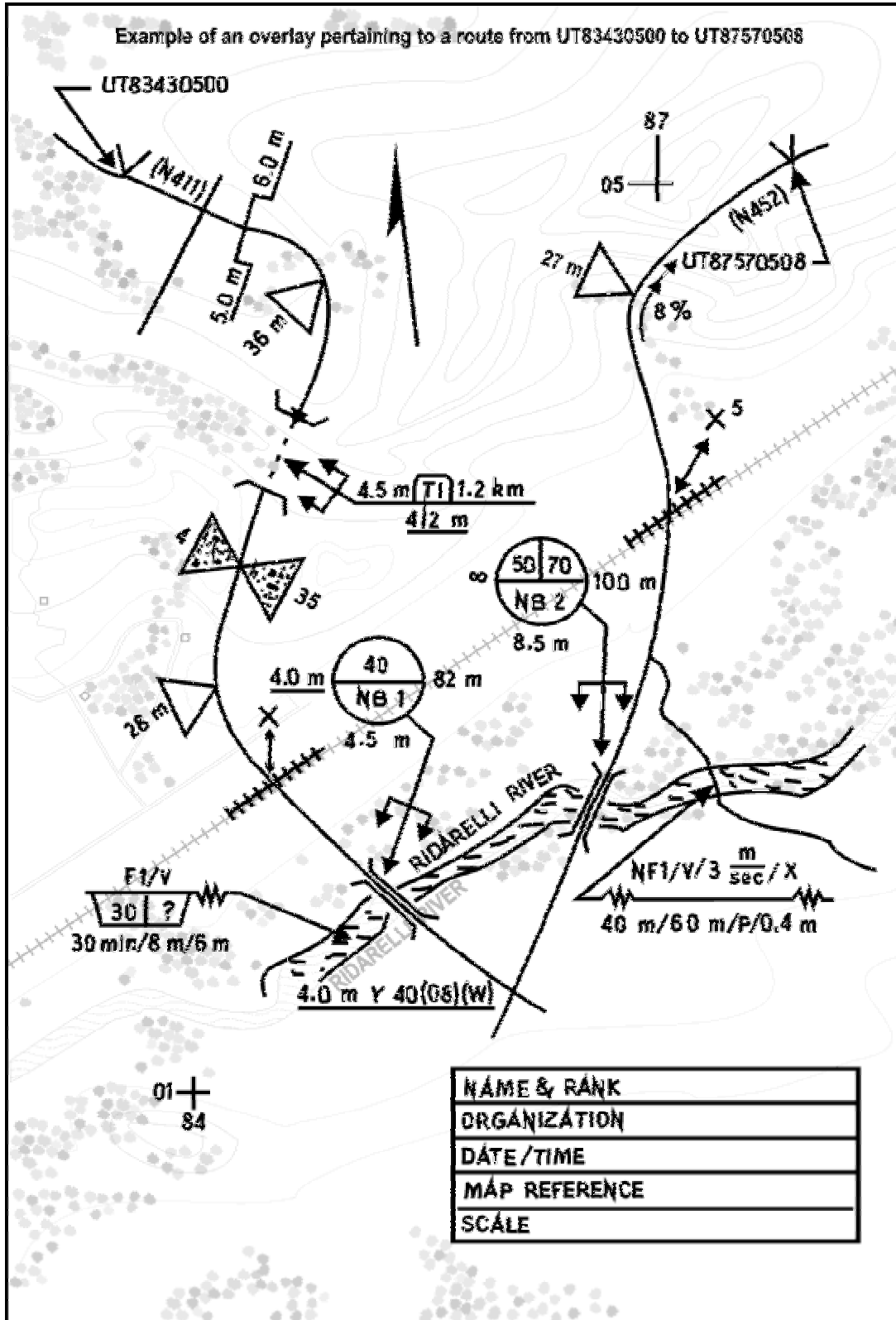

Figure 9-2. Example of overlay graphics.

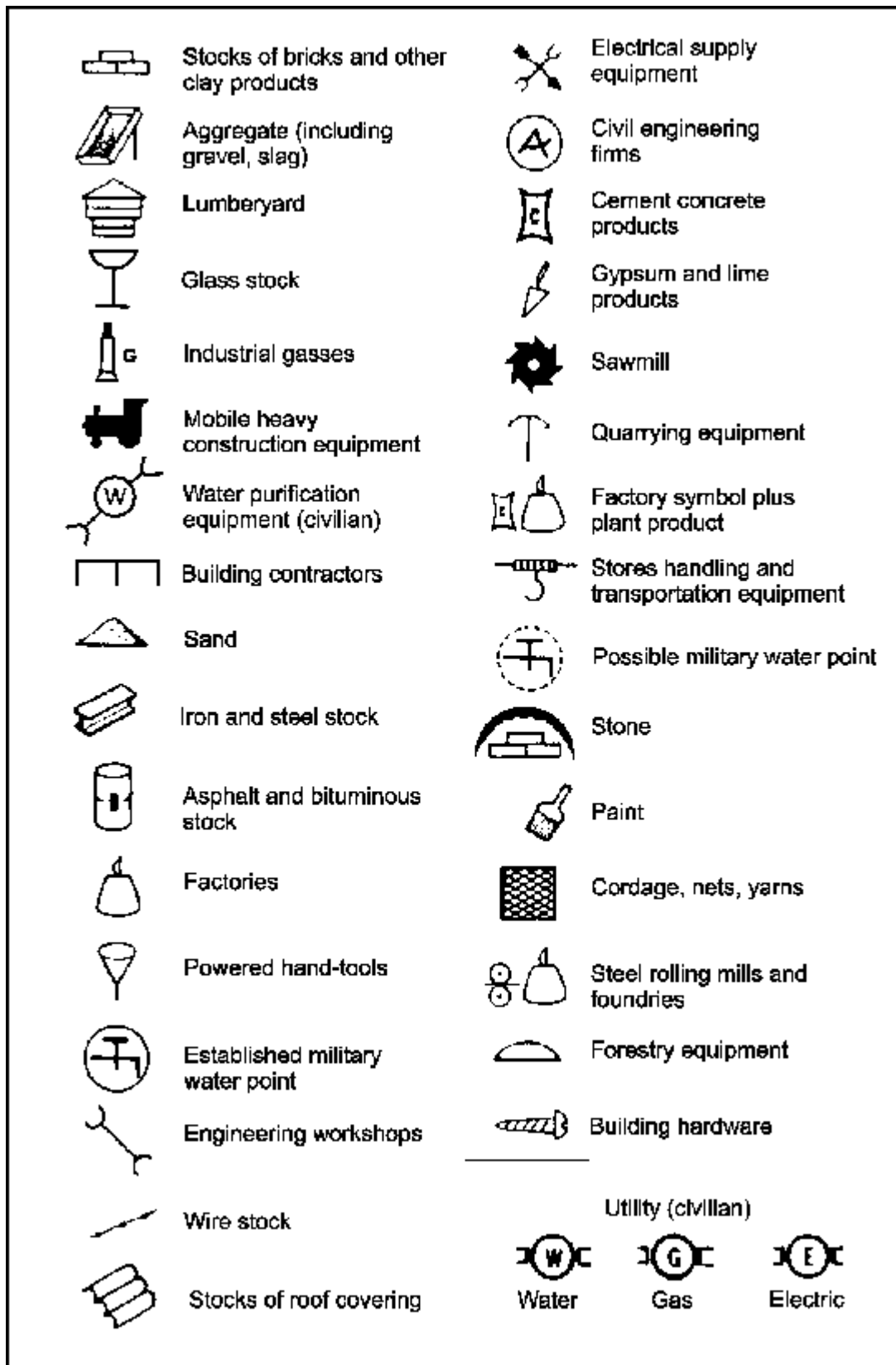

Figure 9-3. Material, facility, equipment, and service symbols.

SECTION 2 — FIELD EXPEDIENT FORMULAS

This section covers formulas that scouts will find useful in water crossing operations and in determining the slope of a road or other piece of terrain. The information is adapted from FM 5-34.

FORMULAS FOR WATER OBSTACLES

Width

Scouts can measure the width of a river or stream using one of several available methods:

- Stretching a string or measuring tape across the river or stream.
- Using a map scale.
- Using a compass and the basic mathematical computation illustrated in [Figure 9-4](#).

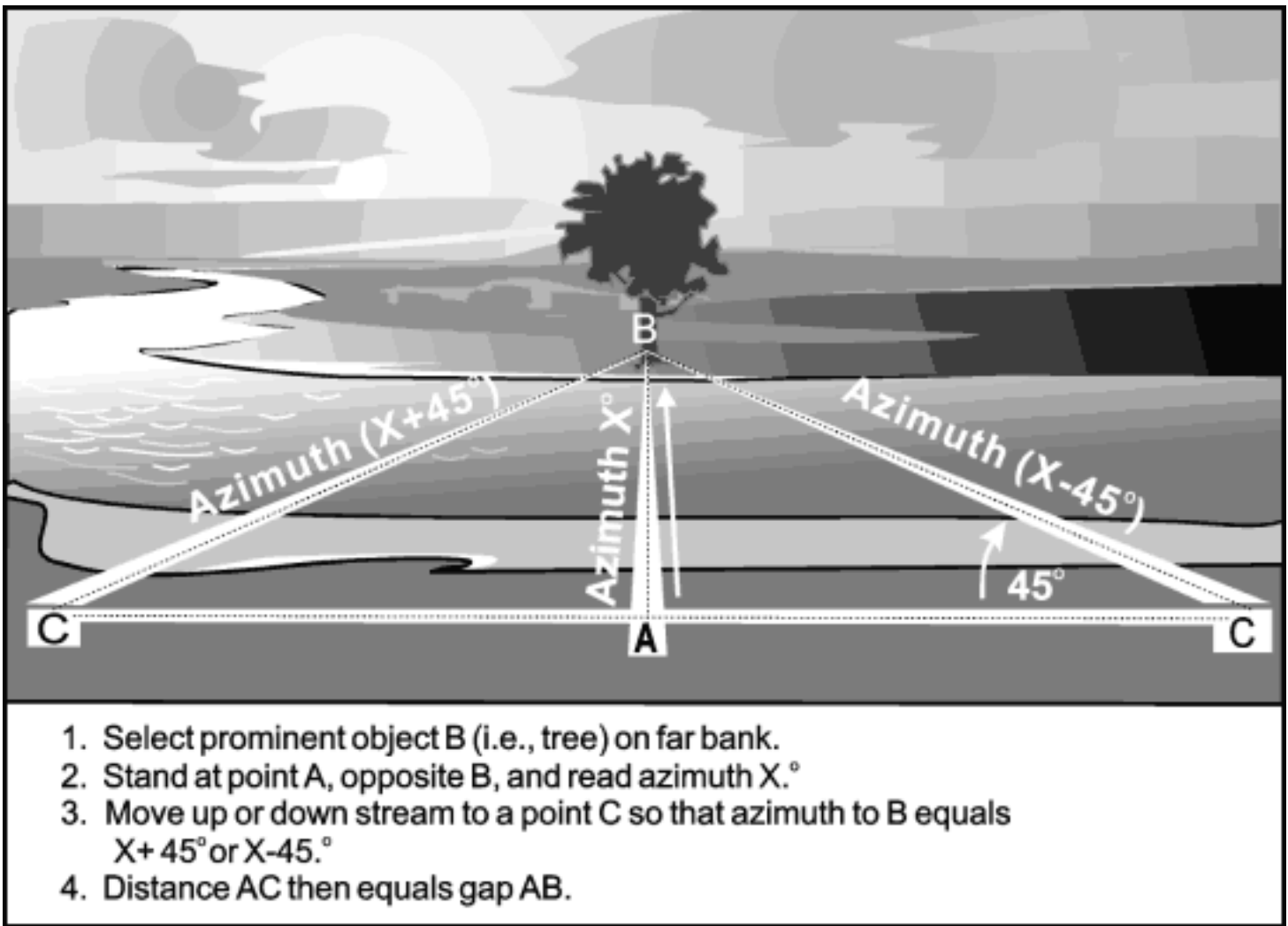

Figure 9-4. Measuring stream width with a compass.

Velocity

Scouts can measure the velocity of the current of a river or stream using the procedures shown in [Figure 9-5](#).

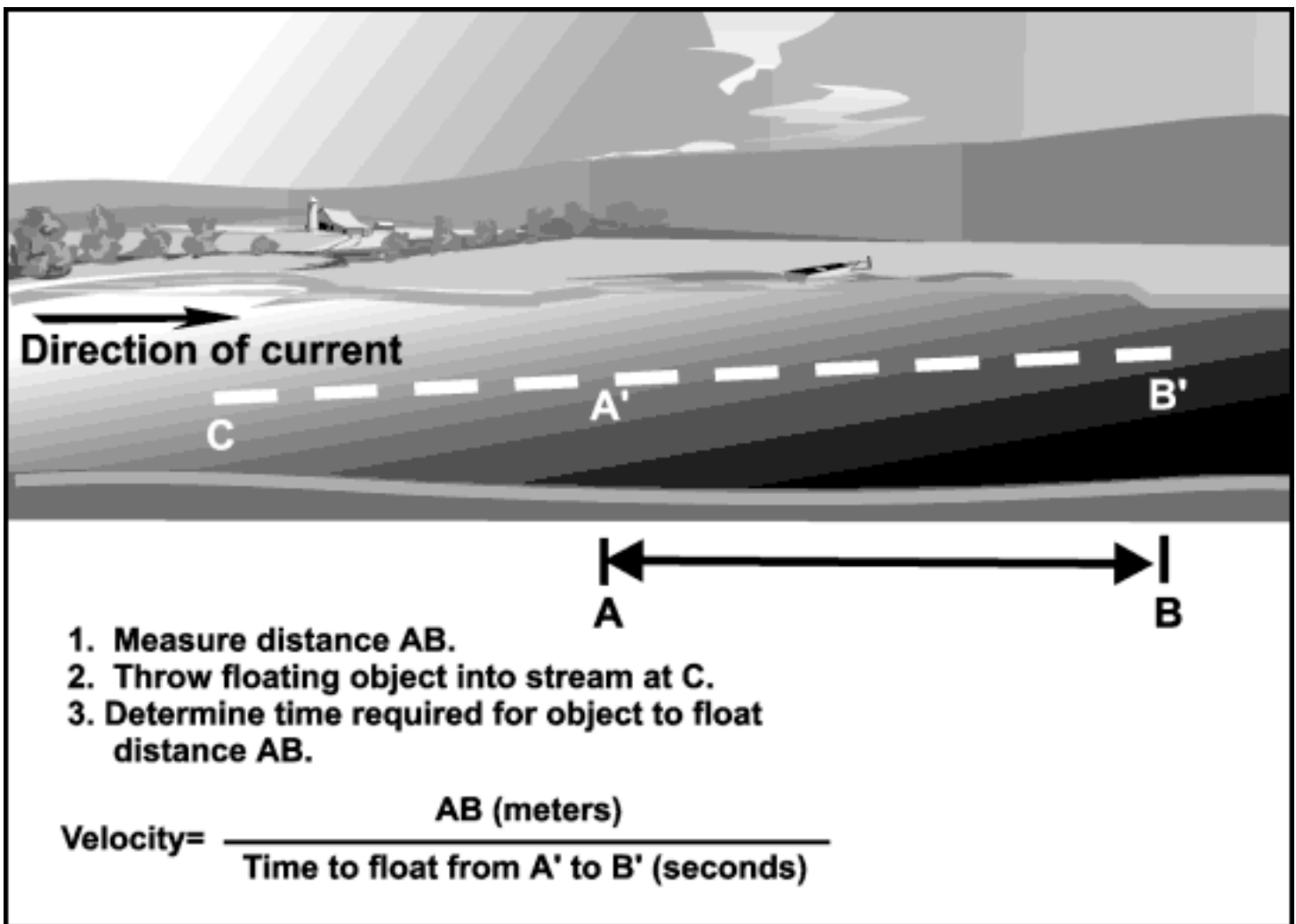

Figure 9-5. Measuring stream velocity.

SLOPE COMPUTATION

[Figure 9-6](#) illustrates several methods that scouts can use to determine the slope of a piece of ground, whether it is an established roadway or a cross-country route. These procedures are included:

- Using a clinometer.
- Using a slope computation formula in which horizontal and vertical distances are computed based on the map scale and contour differences for the road or terrain.
- Using a hasty method in which pacing and eyesight are used to determine horizontal and vertical distances for the slope computation formula.

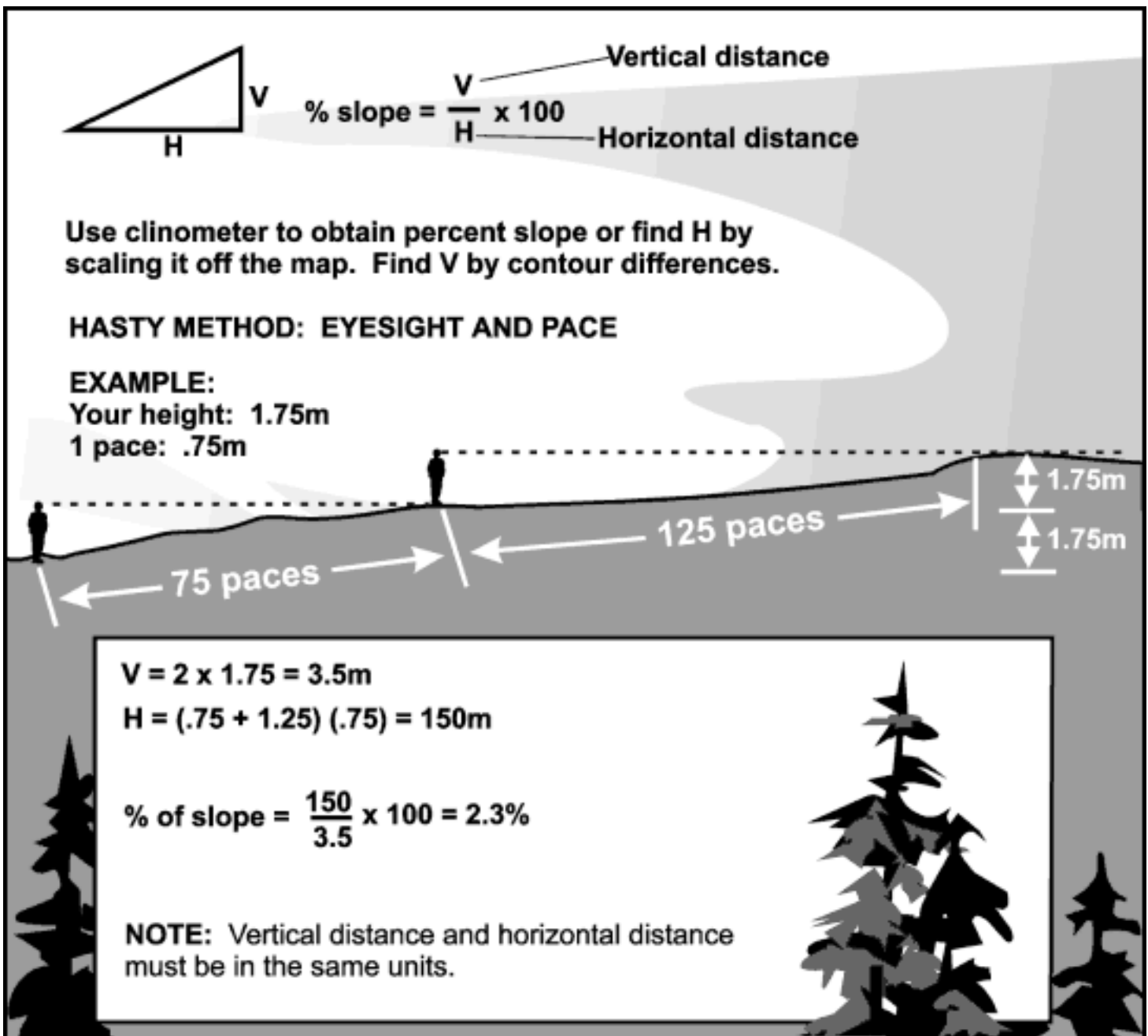

Figure 9-6. Slope computation (road gradient).

SECTION 3 — MEASUREMENT CONVERSIONS

This section includes tables covering the basic computations for converting English measurements to their metric equivalents. The following conversions are included:

- [Table 9-1](#) lists conversions for common distance measurements (inches to centimeters; feet to meters; yards to meters; miles to kilometers).
- [Table 9-2](#) shows conversions of miles per hour to kilometers per hour.

Table 9-1. English to metric distance measurement conversions.

INCHES to CENTIMETERS

1 inch	= 2.54 centimeters
2 inches	= 5.08 centimeters
3 inches	= 7.62 centimeters
4 inches	= 10.16 centimeters
5 inches	= 12.70 centimeters
6 inches	= 15.24 centimeters
7 inches	= 17.78 centimeters
8 inches	= 20.32 centimeters
9 inches	= 22.86 centimeters
10 inches	= 25.40 centimeter
20 inches	= 50.80 centimeters
30 inches	= 76.20 centimeters
40 inches	= 101.60 centimeters
50 inches	= 127.00 centimeters
60 inches	= 152.40 centimeters
70 inches	= 177.80 centimeters
80 inches	= 203.20 centimeters
90 inches	= 228.60 centimeters
100 inches	= 254.00 centimeters

FEET to METERS

1 foot	= 0.30 meters
2 feet	= 0.61 meters
3 feet	= 0.91 meters
4 feet	= 1.22 meters
5 feet	= 1.52 meters
6 feet	= 1.83 meters
7 feet	= 2.13 meters
8 feet	= 2.44 meters
9 feet	= 2.74 meters
10 feet	= 3.05 meters
20 feet	= 6.10 meters
30 feet	= 9.14 meters
40 feet	= 12.19 meters
50 feet	= 15.24 meters
60 feet	= 18.29 meters
70 feet	= 21.34 meters
80 feet	= 24.38 meters
90 feet	= 27.43 meters
100 feet	= 30.48 meters

YARDS to METERS

1 yard	= 0.91 meters
2 yards	= 1.83 meters
3 yards	= 2.74 meters
4 yards	= 3.66 meters
5 yards	= 4.57 meters
6 yards	= 5.49 meters
7 yards	= 6.40 meters
8 yards	= 7.32 meters
9 yards	= 8.23 meters
10 yards	= 9.14 meters
20 yards	= 18.29 meters
30 yards	= 27.43 meters
40 yards	= 36.58 meters
50 yards	= 45.72 meters
60 yards	= 54.86 meters
70 yards	= 64.00 meters
80 yards	= 73.15 meters
90 yards	= 82.30 meters
100 yards	= 91.44 meters

MILES to KILOMETERS

1 mile	= 1.61 km
2 miles	= 3.22 km
3 miles	= 4.83 km
4 miles	= 6.44 km
5 miles	= 8.05 km
6 miles	= 9.66 km
7 miles	= 11.27 km
8 miles	= 12.87 km
9 miles	= 14.48 km
10 miles	= 16.09 km
20 miles	= 32.19 km
30 miles	= 48.28 km
40 miles	= 64.37 km
50 miles	= 80.47 km
60 miles	= 96.56 km
70 miles	= 112.65 km
80 miles	= 128.75 km
90 miles	= 144.84 km
100 miles	= 160.93 km

Table 9-2. Miles per hour to kilometers per hour conversions.

IMILES PER HOUR

1 mph
 2 mph
 3 mph
 4 mph
 5 mph
 6 mph
 7 mph
 8 mph
 9 mph
 10 mph
 15 mph
 20 mph
 25 mph
 30 mph
 35 mph
 40 mph
 45 mph
 50 mph
 55 mph
 60 mph
 65 mph
 70 mph
 75 mph
 100 mph

KILOMETERS PER HOUR

1.609 kmph
 3.22 kmph
 4.83 kmph
 6.44 kmph
 8.05 kmph
 9.66 kmph
 11.27 kmph
 12.87 kmph
 14.48 kmph
 16.09 kmph
 24.14 kmph
 32.19 kmph
 40.23 kmph
 48.28 kmph
 56.33 kmph
 64.37 kmph
 72.42 kmph
 80.47 kmph
 88.51 kmph
 96.56 kmph
 104.61 kmph
 112.65 kmph
 120.70 kmph
 160.94 kmph

SECTION 4 — FIELD EXPEDIENT ANTENNAS

During the execution of the scout platoon's missions, it is very likely that an antenna will be broken or damaged, resulting in a reduction or total loss of communications ability. This section covers how to repair broken or damaged antennas; it also provides instructions on how to construct replacement antennas that will allow the platoon to restore internal communications and to regain communications with the battalion task force or cavalry troop.

ANTENNA TYPES

Direction and distance are critical factors in determining what type of antenna to use based on the platoon's communications requirements. Antennas are categorized in three basic types. This discussion explains how to construct each of these antennas, which have the following capabilities and limitations:

- An omnidirectional antenna allows the operator to communicate in all directions.
- A bidirectional antenna allows the operator to communicate in either of two directions.
- A unidirectional antenna allows the operator to communicate in one direction.

Omnidirectional antennas

Vertical antennas are omnidirectional. A vertical antenna can be improvised by using a metal pipe or rod of the right length held erect by guide wires. The lower end of the antenna should be insulated from the ground by placing it on a large block of wood or other insulating material. A vertical antenna can also be a wire supported by a tree or wooden pole.

To construct an omnidirectional antenna, use the quick reference chart in [Table 9-3](#) to first determine the length of WD-1 wire needed. Attach an insulator to one end of the wire and insert the other end, once it has been stripped of all insulation, into the antenna connector on the radio. Secure the wire to the improvised mast and erect the mast. The radio can now transmit and receive. If a tree is used as the mast, tie a rope to the insulator end of the wire, throw the rope over a limb, and pull the insulator up until the wire is vertical.

Table 9-3. Quick reference chart for omnidirectional antennas.

Operating frequency (MHz)	Wire/element length
30	2.38 meters (7 feet 10 inches)
32	2.23 meters (7 feet 4 inches)
34	2.10 meters (6 feet 11 inches)
36	1.98 meters (6 feet 6 inches)
38	1.87 meters (6 feet 2 inches)
40	1.78 meters (5 feet 10 inches)
43	1.66 meters (5 feet 5 inches)
46	1.55 meters (5 feet 1 inch)
49	1.46 meters (4 feet 9 inches)
52	1.37 meters (4 feet 6 inches)
55	1.30 meters (4 feet 3 inches)
58	1.23 meters (4 feet 0 inches)
61	.17 meters (3 feet 10 inches)
64	1.12 meters (3 feet 8 inches)
68	1.05 meters (3 feet 5 inches)
72	.99 meters (3 feet 3 inches)
76	.94 meters (3 feet 1 inch)

If insulated wire is used, be sure to loop the wire around the handle of the radio before attaching it to the antenna connector. If the antenna is made of bare wire, use a stake and insulator to keep the antenna wire from pulling out of the antenna connector on the radio.

Bidirectional antennas

Bidirectional antennas will normally be used as field expedient retransmission stations. The electrical length of the antenna is measured from the antenna terminal on the radio set to the far end of the antenna. The best performance can be obtained by making the antenna longer than necessary and then shortening it, as required, until the best results are obtained.

For this antenna to function efficiently, the ground terminal of the radio set should be connected to a

good earth ground. A 100-foot-long wire antenna will work when the radio is operating in the 30 to 80 MHz frequency range. For high-frequency operation, the antenna wire must be longer. This antenna will improve the range of the radio in the direction the wire is stretched.

To construct a bidirectional antenna, first erect a pole or select a tree in line with the desired direction of communications. The antenna should be at least 20 feet high. If a tree is used, ensure that the wire does not come in contact with any of the branches. Tie a rope to the pole or tree. While holding the other end of the antenna wire, pace off 100 feet in the direction in which you want to communicate. Tie an insulator to the end of the wire. Now prepare a mast or pole for the second support.

To make a pulley, tie a length of WD-1 wire or nylon rope to the top of the mast. Put a rope or wire halyard through the loop and attach it to the other side of the insulator. Leave enough rope to pull the antenna up once the mast is erected. Attach 25 feet of WD-1 wire to the antenna side of the insulator. Make a good electrical connection because this is the antenna lead-in.

Put up the second support about 6 feet beyond the end of the 100-foot antenna. This will allow for insulators at each end. Pull up the halyard until the antenna is level and tie the end to the supporting pole. Connect the WD-1 wire lead-ins to the radio, which is now ready for operation.

Unidirectional antennas

Dismounted patrols and units of company size and below can greatly improve communications by using field-expedient unidirectional antennas. Such antennas allow them to broadcast farther and receive more clearly. The V-antenna is the easiest antenna of this type to construct. It consists of two wires that form a V, with the open end pointing to the desired direction of transmission/reception.

To construct a V-antenna, first select a mast that is about 10 feet in length. Cut a section of WD-1 wire that is the correct length for the selected operating frequency; secure one end to the connecting plug on the radio. Holding the center of the wire, secure it to the main mast, wrapping it around the top of the mast several times. Take the two ends and secure them to two separate masts, forming a V shape, or secure them to the ground diagonally to form the V.

Attach an insulator to both ends of the wire, about 2 feet from the end of each. Ground the radio by wrapping a length of WD-1 wire around the radio handle and grounding it to a stake in the ground.

REPAIR TECHNIQUES

Whip antennas

The following paragraphs cover procedures for repairing two types of whip antennas. These procedures will allow the vehicle crew to regain communications until a replacement antenna can be obtained.

Metallic antennas. To repair a broken metallic antenna, first scrape the paint three to six inches off the ends of the broken sections; this can be accomplished using sand, rocks, metal, or a knife. Be sure to remove as much paint as possible. Once the paint has been removed, overlay the cleaned ends of the antenna and wrap them tightly together using 12 to 15 inches of copper wire or stripped WD-1 wire. Place a dry stick, MRE spoon, or some other stiff support on each side of the splice and secure this with tape, WD-1 wire, or whatever is available.

Fiberglass antennas. To repair a fiberglass whip antenna, measure a 5-foot length of coaxial cable. Strip the rubber sleeve from the cable, and separate the braided shield from the center conductor. Lash a dry, 10-foot pole to the antenna base. Tape the center conductor to the top of the pole and the braided shield to the bottom. Tape the stripped cable in several more places along the pole so it will stay in place. If there is a twist-lock connector on the cable, connect it to the radio; if not, wedge the center conductor firmly into the antenna connector and attach the braided shield to a screw head on the radio case.

Wire antennas

Emergency repair of a wire antenna may involve the repair or replacement of the wire used as the antenna or transmission line or the repair or replacement of the assembly used to support the antenna. Ensure that the replacement wires are as close as possible to the original wire length and the connections are soldered when possible. Use electrical tape, if available, for added support. Antenna supports can be replaced using trees, tent poles, or telephone poles. To replace guide ropes, use tent ropes, ropes from tarps, or webbed belts.

Field-expedient repair items

[Table 9-4](#) lists items that can be helpful in making field expedient repairs to various pieces of equipment.

Table 9-4. Useful materials in field expedient repairs.

ORIGINAL ITEM	FIELD EXPEDIENT REPAIR ITEM
Antenna wire	WD-1, barbed wire, electrical wire, coaxial cable
Antenna mast	Trees, strikes, lance pole, telephone pole
Coaxial cable	WD-1, electrical wire
Antenna guide wire	Wire, cloth belts
Whip antenna	Wire, WD-1, coaxial cable
Insulators	Plastic rings, MRE spoons, plastic bags wood, rope, bottles

SECTION 5 — SURVIVAL

Survival is largely a matter of mental outlook. The will to survive is the most important factor. In a group or alone, people faced with survival in the wild will experience emotional problems resulting from shock, fear, despair, loneliness, and boredom. In addition to these mental hazards, injury, pain, fatigue, hunger, or thirst will tax the will to live.

Soldiers who are not mentally prepared to overcome all obstacles and to expect the worst will find their chances of survival greatly reduced. They can alleviate the shock of being isolated behind enemy lines, in a desolate area, or in enemy hands by remembering the following survival tips, keyed to individual letters of the word "survival":

- **S** - Size up the situation by considering the individual, the country, and the enemy.
- **U** - Undue haste makes waste. Do not be too eager to move. Do not lose your temper.
- **R** - Remember where you are.
- **V** - Vanquish fear and panic. Remember that fear is normal. Controlling fear when injured is especially difficult, and loneliness can cause panic. Planning an escape can keep your mind occupied.
- **I** - Improve the situation. Learn to put up with new and unpleasant conditions.
- **V** - Value living. Hope and a real plan for escape reduce fear and improve the chance of survival. Health and strength must be conserved. Hunger, cold, and fatigue lower efficiency and stamina. Remember that your goal is to get out alive.
- **A** - Act like the natives.
- **L** - Learn basic skills.

FOOD AND WATER

Water collection

Without water, the chances of survival are nil and all the food in the area means nothing. When there is no surface water, it will be absolutely necessary to tap into the earth's water table for ground water. In rocky soil, look for springs and seepage; in loose soil, look for ground water along valley floors or on the slopes bordering the valley. Springs and seepage can also be found above the high water mark of rivers and streams. In desert or arid lands, natives often know where lingering surface pools are located in low places and will cover these with brush heaps.

Places that are visibly damp, where animals have scratched, or where flies hover indicate recent surface water. Collect dew on clear nights by sponging it up with a handkerchief; in heavy dew, it should be possible to collect about a pint an hour. On mountains, dig in dry stream beds, where water can often be found under the gravel. In snowfields, put snow in a container and place it in the sun, out of the wind.

A water still can be built using a 6-foot-square piece of clean plastic, a 2-to-4-quart container, and a 5-foot piece of flexible tubing. First pick an unshaded spot for the still, and dig a hole about 3 feet across and about 18 inches deep. Place the container in the bottom of the hole and tape one end of the flexible tube inside. Lay the plastic sheet over the hole and pile enough dirt or rocks around the edge to hold it firmly in place. Place a fist-size rock in the center of the plastic sheet and adjust the sheet as necessary to bring it to within a couple of inches of the container. Heat from the sun will evaporate the ground water, which then condenses under the plastic. The water trickles down and drops into the container; it can be drunk using the tubing.

Food sources

There are at least 300,000 different kinds of wild plants in the world. A large number of them are edible, although some are tastier than others. Never eat a large quantity of a strange food without first testing it.

Prepare a cooked sample, then take a mouthful, chew it, and hold it in your mouth for five minutes. If it tastes good, it is generally safe to eat. If the taste is bitter or you develop a burning or nauseating feeling, do not eat the rest. In general, if you observe an animal eating the plant, it will be safe for you to eat. Avoid eating plants that have milky juices; they are not fit for consumption.

Animal food contains the most nutrient value per pound. Anything that creeps, crawls, swims, or flies is a possible source of food. Small game animals, such as rabbits and mice, travel on paths through vegetation. Set traps or snares on or over these trails. Fishhooks can be made from items with points or pins, such as nail files or collar insignia, or from bird bones, fish spines, and pieces of wood.

Hot meals are beneficial to morale, and proper heating kills many germs. Boiling is the best way to cook food in the wild; it preserves the food's natural juices and does not require a large fire.

SHELTERS

Construct a shelter based on whether you need protection from rain, cold, heat, sunshine, or insects and on how long you will be camped. Pick the location for a camp carefully. Make sure it is in a concealed location away from trails or roads. Try to camp near food and water sources. Do not make camp at the base of a steep slope or in areas threatened by avalanches, floods, rockfalls, or battering winds. Ponchos, tarps, palm fronds, limbs, and branches can be used to build shelters. In snowfields, snowcaves or igloos can be constructed for shelter.

SECTION 6 — ENEMY WEAPONS, VEHICLES, AND AIRCRAFT

This section provides the scout platoon members with a guide to some of the common armored vehicles and attack helicopters with which the platoon may come in contact on the battlefield. For the scout platoon to complete its mission, it must stay alive. It is therefore very important that the scouts know in detail what enemy weapon systems are on the battlefield as well as their ranges, capabilities, and the manner in which they will be employed. [Figure 9-7](#) lists specifications for various potential enemy systems.

<p>T-54 and T-55</p> <p>RECOGNITION FEATURES:</p> <ul style="list-style-type: none"> • Fully tracked. • Five road wheels (gap between first and second road wheels); no support rollers. • Dome-shaped turret mounted over third road wheel. • Sloped, low-silhouetted hull. • Bore evacuator at muzzle. • Infrared headlights. • Infrared searchlight for gun. • Straight front infantry handrail. <p>USERS: Russia, India, Israel (with 105-mm gun), People's Republic of China, Mideast countries, former Warsaw Pact countries, Nicaragua, Cuba, and North Korea.</p> <p>ARMAMENT:</p> <ul style="list-style-type: none"> • One 100-mm gun with maximum range of 3,000 m, and maximum effective range of 1,500 m. • One 7.62-mm machine gun with maximum range of 3,500 m, and maximum effective range of 1,000 m. • One 12.7-mm antiaircraft machine gun with maximum range of 7,000 m, and maximum effective range of 2,000 m.* <p>EMPLOYMENT: Main battle tank in Category II follow-on forces. Main battle tank of Korea.</p> <p>*Not all T-55s mount the turret-roof, 12.7-mm machine gun.</p>	
<p>T-62</p> <p>RECOGNITION FEATURES:</p> <ul style="list-style-type: none"> • Fully tracked. • Five road wheels (greater spacing between third, fourth, and fifth road wheels); no support rollers. • Dome-shaped turret over third road wheel. • Flat, low-silhouetted hull. • Bore evacuator one-third distance from muzzle. • Curved front infantry handrail. <p>USERS: Russia, Mideast countries, former Warsaw Pact countries, North Korea.</p> <p>ARMAMENT:</p> <ul style="list-style-type: none"> • One 115-mm main gun (smoothbore, high velocity) with maximum range of 3,000m, and maximum effective range of 1,500m. • One 7.62-mm coaxial machine gun with maximum range of 4,000m, and maximum effective range of 1,000m. • One 12.7-mm antiaircraft machine gun with maximum range of 7,850 m, and maximum effective range of 2,000m.* <p>EMPLOYMENT: Main battle tank in Category II follow-on forces.</p> <p>*Not all T-62s mount the turret-roof, 12.7-mm machine gun.</p>	

Figure 9-7. Enemy weapons, vehicles, and aircraft.

<p>T-64</p> <p>RECOGNITION FEATURES:</p> <ul style="list-style-type: none"> • Six small, stamped, evenly spaced road wheels with four support rollers. • Infrared light mounted left of main gun. • Sharply sloped upper glacis with V-shaped splash guard. • Rear exhaust vents. • Dual-snorkel system stowed on rear of turret. • External ammunition storage boxes on sides of turret. • New design turret machine gun, which can be fired while buttoned up. <p>USERS: Russia.</p> <p>ARMAMENT:</p> <ul style="list-style-type: none"> • One 125-mm smoothbore main gun with maximum range of 4,000+ m, and maximum effective range of 2,100 m. • One 12.7-mm antiaircraft machine gun (turret mounted) with maximum range of 7,850 m, and maximum effective range of 2,000 m. • One 7.62-mm coaxial machine gun with maximum range of 4,000 m, and maximum effective range of 1,000 m. • Reactive armor. <p>EMPLOYMENT: Main battle tank in first-echelon armored units. T-64B fires missile and has reactive armor.</p>	
<p>T-72</p> <p>RECOGNITION FEATURES:</p> <ul style="list-style-type: none"> • Six large die-cast, evenly spaced road wheels with three support rollers. • Sharply sloped upper glacis with V-shaped splash guard. • Rounded turret mounted midway on tank. • Single snorkel mounted on left side of turret. • Engine exhaust on top of back deck. • Bore evacuator one-third distance from muzzle. • Infrared light to right of main gun. • New design turret machine gun; no provision for firing from within tank. • Integrated fuel cells and storage containers, giving streamlined appearance to fenders. <p>USERS: Russia, Syria, India, former Warsaw Pact countries. Main export tank of Russia and Iraq.</p> <p>ARMAMENT:</p> <ul style="list-style-type: none"> • One 125-mm smoothbore main gun with maximum range of 4,000+ m, and maximum effective range of 2,100 m. • One 12.7-mm antiaircraft machine gun (turret mounted) with maximum range of 7,850 m, and maximum effective range of 2,000 m. • One 7.62-mm coaxial machine gun with maximum range of 4,000 m, and maximum effective range of 1,000 m. • Reactive armor. <p>EMPLOYMENT: Main battle tank in first-echelon armored units.</p>	

Figure 9-7. Enemy weapons, vehicles, and aircraft (continued).

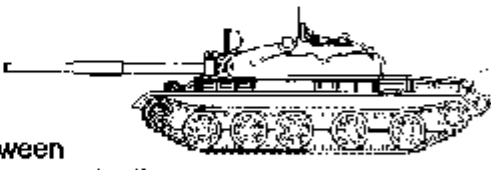

<p>T-80</p> <p>RECOGNITION FEATURES:</p> <ul style="list-style-type: none"> • Six large die-cast, irregularly spaced road wheels with three support rollers. • Sharply sloped upper glacis with V-shaped splash guard. • Seven smoke grenade dischargers on left side of turret; five smoke grenade dischargers on right side of turret. • Single snorkel mounted on rear of turret. • Engine exhaust on rear of hull. • Infrared fuel cells and storage containers, with streamlined fenders. • Laser range finder. <p>USERS: Russia.</p> <p>ARMAMENT:</p> <ul style="list-style-type: none"> • One 125-mm smoothbore main gun with maximum range of 4,000+ m, and maximum effective range of 2,100 m. • One 12.7-mm antiaircraft machine gun (turret mounted) with maximum range of 7,850 m, and maximum effective range of 2,000 m. • One 7.62-mm coaxial machine gun with maximum range of 4,000 m, and maximum effective range of 1,000 m. • AT-8 missile (Songster). • Reactive armor. <p>EMPLOYMENT: Main battle tank in first-echelon units.</p>	
<p>T-90</p> <p>RECOGNITION FEATURES:</p> <ul style="list-style-type: none"> • Most body features similar to those of the T-80. • Six 81-mm smoke grenade launchers on either side of turret. • Laser range finder. <p>USERS: Russia.</p> <p>ARMAMENT:</p> <ul style="list-style-type: none"> • One 125-mm smoothbore main gun with maximum range of 4,000+ m, and maximum effective range of 2,100 m. • One 12.7-mm antiaircraft machine gun (turret mounted) with maximum range of 7,850 m, and maximum effective range of 2,000 m. • One 7.62-mm coaxial machine gun with maximum range of 4,000 m, and maximum effective range of 1,000 m. • AT-11 SNIPER. • Reactive armor. <p>EMPLOYMENT: Main battle tank in first-echelon units.</p>	

Figure 9-7. Enemy weapons, vehicles, and aircraft (continued).

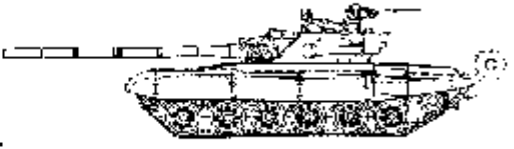
<p>2S1 122-mm SP HOWITZER</p> <p>RECOGNITION FEATURES:</p> <ul style="list-style-type: none">• Seven road wheels; no support rollers.• Short, flat turret set back on hull.• Gun tube flush with forward edge.• Tear-shaped port cover on left side of turret.• Double-baffle muzzle break.• Large, infrared searchlight mounted on left of turret. <p>USERS: Russia, and former selected Warsaw Pact countries.</p> <p>ARMAMENT:</p> <ul style="list-style-type: none">• One 122-mm howitzer with a range of 15,300 m. <p>EMPLOYMENT: Regimental artillery, all-terrain fire support vehicle in tank and motorized rifle divisions usually as close as 1 km to 7 km behind the FEBA. As direct-fire weapon during attack, may follow tanks and armored personnel carriers by 500 m to 1,000 m, attacking infantry and ATGM.</p>	
<p>2S3 152-mm SP HOWITZER</p> <p>RECOGNITION FEATURES:</p> <ul style="list-style-type: none">• Six large, unevenly spaced road wheels.• Four track-return rollers per side.• Double-baffle muzzle brake.• Tube overhang.• Two recoil cylinders above tube.• Large turret set back on hull; turret roof with single rotatable hatch. <p>USERS: Russia.</p> <p>ARMAMENT:</p> <ul style="list-style-type: none">• One 152-mm howitzer with a range of 17,230 m.• One 7.62-mm machine gun with maximum range of 4,000 m, and maximum effective range of 1,000 m. <p>EMPLOYMENT: Equivalent to US M109A3. Should appear as close as 3 km to 7 km behind the FEBA. Normally found in regimental artillery group of motorized rifle regiments and tank regiments.</p>	

Figure 9-7. Enemy weapons, vehicles, and aircraft (continued).

2S19 152-mm SP ARTILLERY SYSTEM	
RECOGNITION FEATURES: <ul style="list-style-type: none">• Chassis based on T-80 tank.• Six large, unevenly spaced roadwheels (same as T-80).• V-shaped splash guard on glacis plate.• Maximum road speed 60 kmph.• Dozer blade mounted under nose of vehicle.• Four hatches, one for each crewmember.	
USERS: Russia.	
ARMAMENT: <ul style="list-style-type: none">• One 152-mm 2A64 gun with standard range of approximately 25,000 m. Fires a variety of rounds, including HE, HEAT, and those available for 2S3 and D-20 systems.• One 12.7-mm machine gun (can be remotely controlled).	
EMPLOYMENT: <p>Developed as replacement for 2S3 system. Normally deployed in batteries of six guns in regimental artillery group of motorized rifle regiments and tank regiments.</p>	
D-20 152-mm TOWED GUN-HOWITZER	
RECOGNITION FEATURES: <ul style="list-style-type: none">• Length in travel position: 8.7 m.• Circular firing pedestal permitting 360-degree traverse.• Shield has irregular top with sliding center section.• Split box-section trails with castor wheels.• Can be towed at speeds up to 60 kmph.	
USERS: Russia (original production source) and numerous countries throughout Europe and Asia (limited employment elsewhere, including Africa and Cuba).	
ARMAMENT: <p>One 152-mm howitzer with standard range of approximately 17,000 m. Fires a variety of rounds, including HE, HEAT, AT/AP, chemical, scatterable mines, and tactical nuclear.</p>	
EMPLOYMENT: Long-range indirect fire elements with mobile capabilities.	

Figure 9-7. Enemy weapons, vehicles, and aircraft (continued).

<p>D-30 122-mm TOWED HOWITZER</p> <p>RECOGNITION FEATURES:</p> <ul style="list-style-type: none">• Length in travel position: 10 m.• Three-trail carriage.• Towing lunette mounted on multibaffle muzzle brake.• Box-shaped covering over recoil mechanism (above tube).• Towed muzzle-first.• Can be towed at speeds up to 80 kmph.• Revolving mount permits 360-degree traverse and high and low angles of fire. <p>USERS: Russia, China. May also have been exported to Middle East.</p> <p>ARMAMENT:</p> <p>One 122-mm howitzer with standard range of approximately 15,000 m. Fires a variety of rounds, including HE, HEAT, smoke, chemical, and illumination.</p> <p>EMPLOYMENT:</p> <p>Long-range indirect fire elements with mobile capabilities. Can be used for direct fire with a range of 1,000 m.</p>	
<p>BMD AIRBORNE COMBAT VEHICLE</p> <p>RECOGNITION FEATURES:</p> <ul style="list-style-type: none">• Tracked vehicle.• Five evenly spaced road wheels; four support rollers (BMD 1979 has six road wheels; five support rollers).• Rear crew compartment.• Flat turret set forward on hull.• Driver's hatch mounted under main gun.• Amphibious.• Boat-shaped hull. <p>USERS: Russia.</p> <p>ARMAMENT:</p> <ul style="list-style-type: none">• One 73-mm main gun with maximum range of 2,200 m, and maximum effective range of 1,000 m.• One AT-3 Sagger/AT-4 mount, three on board. Maximum range 3,000 m.• One 7.62-mm coaxial machine gun with maximum range of 4,000 m, and maximum effective range of 1,000 m.• Two 7.62-mm bow machine gunswith maximum range of 4,000 m, and maximum effective range of 1,000 m. <p>EMPLOYMENT: Air assault units.</p>	

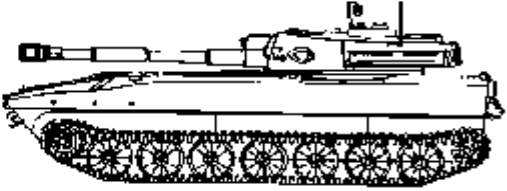
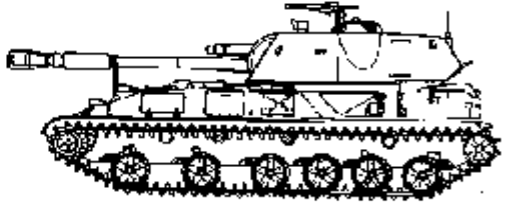
Figure 9-7. Enemy weapons, vehicles, and aircraft (continued).

BMP INFANTRY COMBAT VEHICLE

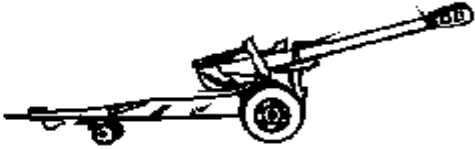
RECOGNITION FEATURES:

- Tracked vehicle.
- Six road wheels; three tracked support rollers.
- Two doors in rear.
- Four hatches on top of crew compartment.
- Low silhouette with flat turret centered on hull.
- Sharp, sloping front with distinctive ridged surface.
- Commander's hatch mounts infrared searchlight.
- Amphibious.

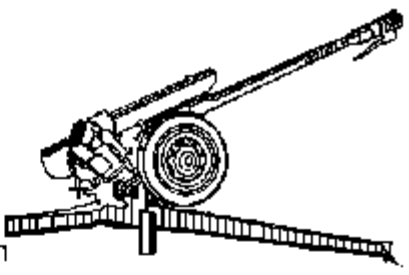
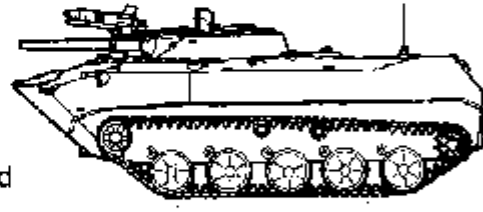
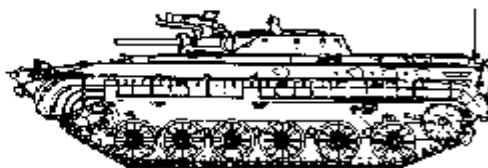

USERS: Russia, Cuba, India, Mideast countries, North Korea, former Warsaw Pact countries.

ARMAMENT:

- One 73-mm short, smoothbore gun with maximum range of 2,200 m, and maximum effective range of 1,000 m.
- Either one AT-3 Sagger, AT-4 Spigot, or AT-5 Spandrel. (Three additional ATGM are carried inside).
 - AT-3 maximum range is 300 m.
 - AT-4 maximum range is 2,000 m.
 - AT-5 maximum range is 5,000 m.
- One 7.62-mm coaxial machine gun with maximum range of 4,000 m, and maximum effective range of 1,000 m.
- Configuration may vary.

EMPLOYMENT: Motorized rifle units.

BMP 2 INFANTRY COMBAT VEHICLE

RECOGNITION FEATURES:

- Tracked vehicle with six road wheels.
- Low circular turret with long, thin gun.
- Low silhouette with pointed nose.
- Ribbed area on front of vehicle.
- Two rear hatches on top decking.
- Two doors in rear hull.
- Three smoke dischargers on turret side.
- Vision ports on hull.
- Amphibious.

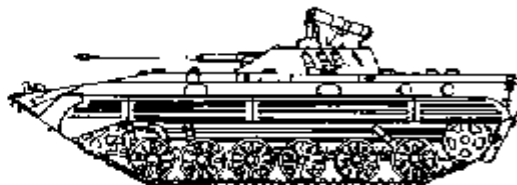

USERS: Russia.

ARMAMENT:

- One AT-5 or AT-4 Spandrel.
 - AT-5 maximum range is 5,000 m.
 - AT-4 maximum range is 2,000 m.
- One 30-mm gun with maximum effective range of 4,000 m.
- 7.62-mm coaxial machine gun with maximum range of 4,000 m, and maximum effective range of 1,000 m.

EMPLOYMENT: Motorized rifle units.

Figure 9-7. Enemy weapons, vehicles, and aircraft (continued).

BMP-3 INFANTRY COMBAT VEHICLE

RECOGNITION FEATURES:

- Tracked vehicle with six unevenly spaced road wheels.
- Low circular turret with long, thin gun.
- Low silhouette with pointed nose.
- Ribbed area on front of vehicle.
- One hatch forward of turret.
- One hatch behind turret.
- Two doors in rear hull.
- Three smoke dischargers on turret side.
- Vision ports on hull.
- Amphibious.

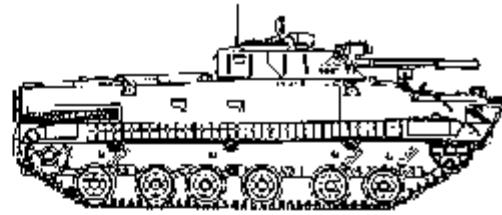

USERS: Cyprus, Kuwait, Russia, UAE (Abu Dhabi).

ARMAMENT:

- One AT-5 or AT-4 Spandrel.
 - AT-5 maximum range is 5,000 m.
 - AT-4 maximum range is 2,000 m.
- One AT-10 STABBER.
- One 30-mm gun with maximum effective range of 4,000 m.
- 7.62-mm coaxial machine gun with maximum range of 4,000 m, and maximum effective range of 1,000 m.

EMPLOYMENT: Motorized rifle units.

BRDM-1

RECOGNITION FEATURES:

- Four large wheels (two on each side).
- Full armor cover.
- Engines on front of vehicle.
- Four small, rough-terrain belly wheels (may be raised or lowered).
- Amphibious.

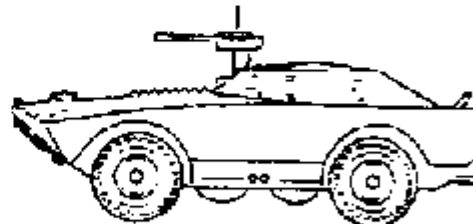

USERS: Russia.

ARMAMENT:

- One 7.62-mm machine gun with maximum range of 4,000 m, and maximum effective range of 1,000 m.
- One 12.7-mm machine gun with maximum range of 7,650 m, and maximum effective range of 2,000 m.

EMPLOYMENT: In reconnaissance units as a scout car. As missile carrier, can mount AT-1 Snapper, At-2 Swatter, or AT-3 Sagger antitank missiles.

Figure 9-7. Enemy weapons, vehicles, and aircraft (continued).

BRDM-2

RECOGNITION FEATURES:

- Four-wheeled car; four retractable belly wheels.
- Box-shaped hull.
- Cone-shaped turret mounted over middle retractable wheels (no turret on command or ATGM versions).
- Infrared spotlight and driving lights.
- Amphibious.
- Ship-like bow.

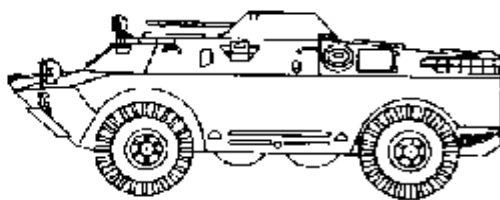

USERS: Russia, Angola, Egypt, Israel, Mali, Mideast countries, former Warsaw Pact countries.

ARMAMENT:

- One 14.5-mm machine gun with maximum range of 7,000 m, and maximum effective range of 2,000 m.
- One 7.62-mm machine gun with maximum range of 4,000 m, and maximum effective range of 1,000m.

EMPLOYMENT: Reconnaissance battalions of motorized and tank divisions and reconnaissance companies of motorized rifle and tank regiments. Also used as ATGM and SA-9 Gaskin carrier. BRDM-2Rkh used for NBC reconnaissance.

BTR-60P and BTR-60PB ARMORED PERSONNEL CARRIER

RECOGNITION FEATURES:

- Four large wheels on each side.
- Open top (BTR-60P).
- Small conical turret (BTR-60PB).
- Boat-shaped hull.
- Side exit and entry hatches
- Well-sloped armor.
- Infrared searchlights above driver's seat.
- Duck-billed amphibious prow.

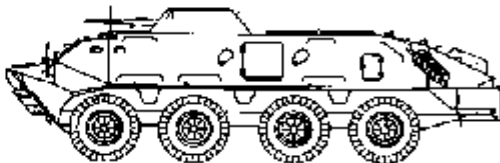

USERS: Russia, Cuba, East Germany, Mideast countries, former Warsaw Pact countries.

ARMAMENT:

- One 14.5-mm machine gun with maximum range of 7,000 m, and maximum effective range of 2,000 m.
- One 7.62-mm machine gun with maximum range of 4,000 m, and maximum effective range of 1,000m.
- Configurations may vary.

EMPLOYMENT: Motorized rifle units and naval infantry units. Command versions present in large numbers in tank, BMP, and BTR units.

Figure 9-7. Enemy weapons, vehicles, and aircraft (continued).

BRDM-2

RECOGNITION FEATURES:

- Four-wheeled car; four retractable belly wheels.
- Box-shaped hull.
- Cone-shaped turret mounted over middle retractable wheels (no turret on command or ATGM versions).
- Infrared spotlight and driving lights.
- Amphibious.
- Ship-like bow.

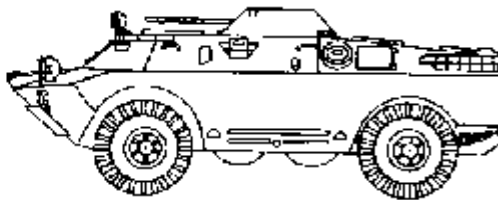

USERS: Russia, Angola, Egypt, Israel, Mali, Mideast countries, former Warsaw Pact countries.

ARMAMENT:

- One 14.5-mm machine gun with maximum range of 7,000 m, and maximum effective range of 2,000 m.
- One 7.62-mm machine gun with maximum range of 4,000 m, and maximum effective range of 1,000m.

EMPLOYMENT: Reconnaissance battalions of motorized and tank divisions and reconnaissance companies of motorized rifle and tank regiments. Also used as ATGM and SA-9 Gaskin carrier. BRDM-2Rkh used for NBC reconnaissance.

BTR-60P and BTR-60PB ARMORED PERSONNEL CARRIER

RECOGNITION FEATURES:

- Four large wheels on each side.
- Open top (BTR-60P).
- Small conical turret (BTR-60PB).
- Boat-shaped hull.
- Side exit and entry hatches
- Well-sloped armor.
- Infrared searchlights above driver's seat.
- Duck-billed amphibious prow.

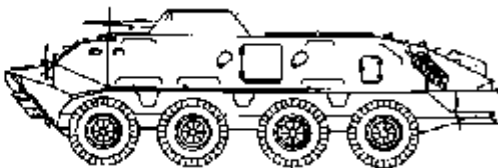

USERS: Russia, Cuba, East Germany, Mideast countries, former Warsaw Pact countries.

ARMAMENT:

- One 14.5-mm machine gun with maximum range of 7,000 m, and maximum effective range of 2,000 m.
- One 7.62-mm machine gun with maximum range of 4,000 m, and maximum effective range of 1,000m.
- Configurations may vary.

EMPLOYMENT: Motorized rifle units and naval infantry units. Command versions present in large numbers in tank, BMP, and BTR units.

Figure 9-7. Enemy weapons, vehicles, and aircraft (continued).



<p>MT-LB</p> <p>RECOGNITION FEATURES:</p> <ul style="list-style-type: none"> ▪ Tracked vehicle. ▪ Six road wheels; no support rollers. ▪ Low silhouette. ▪ Cone-shaped turret on right front. ▪ Sloping sides and front; vertical back. ▪ Amphibious. <p>USERS: Russia, East Germany.</p> <p>ARMAMENT:</p> <ul style="list-style-type: none"> • 7.62-mm machine gun with maximum range of 4,000 m, and maximum effective range of 1,000m. <p>EMPLOYMENT: Multirole vehicle (troop carrier, maintenance, prime mover for towed artillery, command and control). Also used as chassis for other equipment and weapon systems (SA-13, Big Fred, 122-mm SP howitzer, NBC reconnaissance vehicle, and mine clearer).</p>	
<p>ARMORED COMMAND AND RECONNAISSANCE VEHICLE (ACRV)</p> <p>RECOGNITION FEATURES:</p> <ul style="list-style-type: none"> • Tracked vehicle. • Seven road wheels; no support rollers. • Round turret mounted near back. • Vertical back with exit door. • Large antennas may be mounted on hull top. <p>USERS: Russia.</p> <p>ARMAMENT:</p> <ul style="list-style-type: none"> • One turret-mounted 12.7-mm machine gun with maximum range of 7,850 m, and maximum effective range of 2,000 m. <p>EMPLOYMENT: One version as a mobile command operations post for artillery battalion and battery commanders; other as a fire direction center.</p>	
<p>PRP-3 SMALL FRED</p> <p>RECOGNITION FEATURES:</p> <ul style="list-style-type: none"> • Mounted on BMP chassis. • Folding blade-like radar located on turret rear. <p>USERS: Russia.</p> <p>ARMAMENT:</p> <ul style="list-style-type: none"> • One 7.62-mm machine gun with maximum range of 4,000 m, and maximum effective range of 1,000 m. <p>EMPLOYMENT: Used by artillery battalions for target acquisition.</p>	

Figure 9-7. Enemy weapons, vehicles, and aircraft (continued).

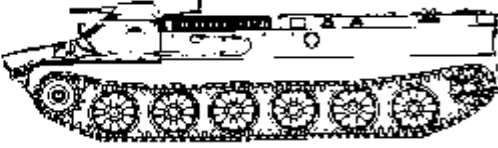
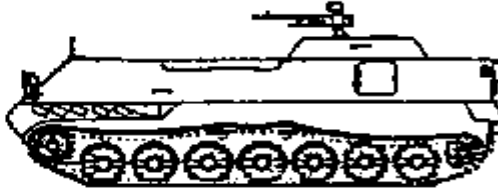
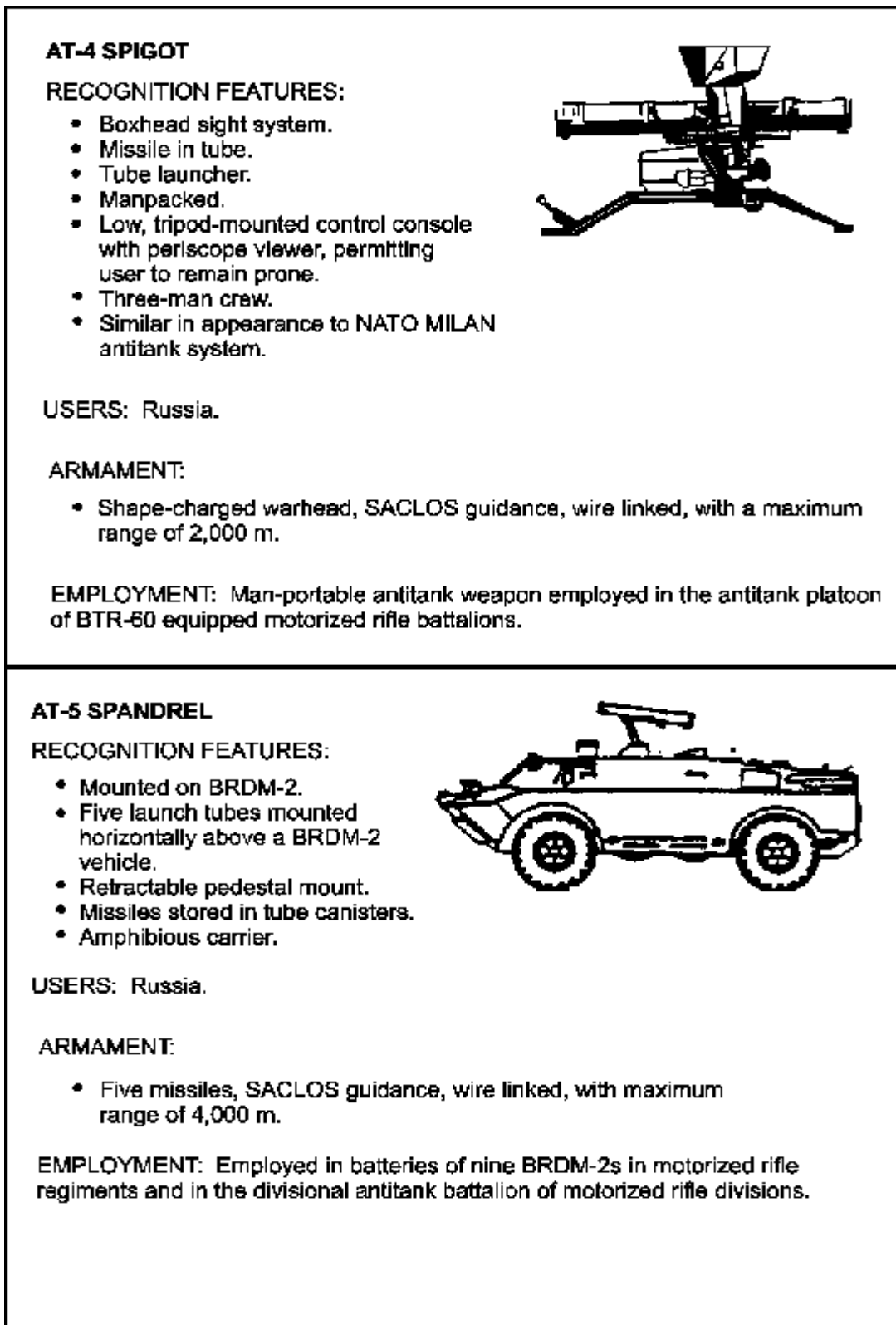

Figure 9-7. Enemy weapons, vehicles, and aircraft (continued).

MI-26 HALO

RECOGNITION FEATURES:

- Seven-bladed main rotor; five-bladed tail rotor.
- Twin engines.
- No wings.
- External nonretractable tricycle landing gear.



USERS: Russia.

ARMAMENT:

- Two door-mounted 12.7-mm machine guns.

EMPLOYMENT: General support of military units with primary use in troop and cargo (heavy lift) transport. Replacing MI-6 Hook. May be able to transport one BMP or two BMD.

MI-24 HIND D and E

RECOGNITION FEATURES:

- Five-bladed main rotor; three-bladed tail rotor.
- Two tandem-bubble canopies.
- Short, stubby weapons-carrying wings mounted at mid-fuselage.
- Retractable tricycle landing gear.

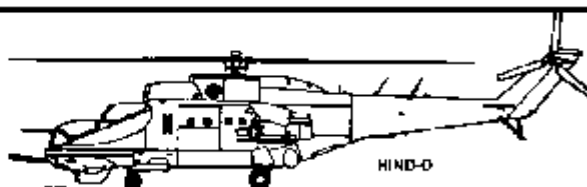

The HIND is a multipurpose helicopter capable of carrying eight fully equipped combat troops besides a complete external armament load. Besides the standard pylon armament, the HIND D incorporates a turret which houses a four-barrel, 12.7-mm Gatling-type gun. The sensor pack under the nose of the HIND D probably carries an optical sight system. The HIND E carries four AT-6 ATGM (radio-linked) which travel at 500 m per second. It may have a FLIR (forward-looking infrared) or low-light level TV system.

USERS: Russia, Algeria, Czech Republic, Slovakia, Iraq, Lybia, Peru, Syria, numerous former Warsaw Pact countries.

ARMAMENT:

- One 12.7-mm machine gun.
- Four 32-shot, 57-mm rocket pods.
- Four AT-2 ATGM (HIND D).
- Four AT-6 ATGM (HIND E).
- HIND D variant carries a twin-barrel, 23-mm cannon.

EMPLOYMENT: Support of military units as a combat assault, scout, and armed gunship. Also used in close air support, antiarmor, and antihelicopter operations. May be found in the independent attack helicopter regiment of a frontal Tactical Air Army, Combined Arms Army, and in the helicopter squadrons of motorized rifle and tank divisions. Six HIND Ds per division.

MI-28 HAVOC

RECOGNITION FEATURES:

- Five-bladed main rotor.
- Elongated nose.
- Two-man crew.
- Gun turret (30-mm) below nose.
- Short, stubby wings attached at midfuselage.

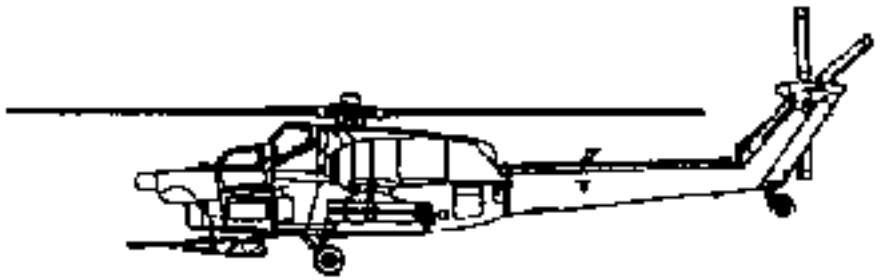

USERS: Russia.

ARMAMENT:

- One 30-mm gun.
- Sixteen AT-6 ATGM.
- Unknown number of AA-8/SA-14 missiles.

EMPLOYMENT: Used in support of ground units as combat gunship. Primary mission is antiarmor but can be used in close air support and air-to-air roles.

Figure 9-7. Enemy weapons, vehicles, and aircraft (continued).

APPENDIX A

Combat Orders

Combat orders are the means by which the scout platoon leader receives and transmits information, from the earliest notification that an operation will occur through the final phases of execution. They are absolutely critical to mission success. All members of the scout platoon must be familiar with the formats of warning orders, OPORDs, and FRAGOs.

CONTENTS

[Section 1](#) [Warning Orders](#)

[Section 2](#) [Operation Orders](#)

[Section 3](#) [Fragmentary Orders](#)

SECTION 1 — WARNING ORDERS

The scout platoon leader will use warning orders to alert his platoon of upcoming missions. The guidelines and directions in the warning order will allow the platoon to begin its planning and preparation activities. The platoon leader then can use a series of warning orders to provide additional information to the platoon as he receives it or as he further develops his plan. The warning order should provide answers to the following questions:

- **WHO** is involved in the mission?
- **WHAT** is the nature of the mission and what are we tasked to accomplish?
- **WHY** are we performing the mission?
- **WHEN** is the earliest starting time expected for the mission?
- **WHERE** is location of the area of operations and where and when will the OPORD be issued?

At a minimum, all scout platoon warning orders will include the following elements:

- **Situation.**
 - **Enemy.** Define the area of operations and area of interest. Give a brief layout of the terrain using OCOKA factors.
 - **Friendly.** State your intent and the mission statements for the next two higher levels. Explain

the next higher commander's concept of the operation and provide a copy of the available operational graphics.

- **Mission.** Give the restated scout platoon mission.
- **Coordinating instructions.** Provide the platoon with all of the limitations identified up to this point and any other instructions that will allow for proactive planning and preparation, including priorities of work. The following elements may be included:
 - **Timeline.** Update your earlier timeline(s). Outline all known beginning and ending times, to include those for the next higher unit.
 - **Rehearsals.** Specify what type of mission-specific rehearsals or drills you expect subordinate units to conduct within the framework of the timeline.
 - **Security.** Brief the security plan.
 - **Service support.** Address any changes to the support requirement for which the platoon may have to plan, such as attachment of an engineer platoon or infantry squad.

SECTION 2 — OPERATION ORDERS

The OPORD provides the platoon with the essential information required to conduct the operation and to carry out the higher commander's intent. The scout platoon leader should provide subordinate leaders with a copy of his OPORD format to facilitate note-taking. All scout platoon OPORDs will use the format shown in [Figure A-1](#) to present the necessary operational information.

TASK ORGANIZATION

- Time(s) of attachment.
- Time(s) of detachment.
- Support relationship(s).

PARAGRAPH 1 - SITUATION

a. Enemy forces (and battlefield conditions).

(1) Weather and light data.

- Precipitation.
- Temperature.
- Other weather conditions (such as wind, dust, or fog).
- Light data:

BMNT: _____. Sunrise: _____.

Sunset: _____. EENT: _____.

Moonrise: _____. Moonset: _____.

Percent Illumination: _____.

(2) Terrain (factors of OCOKA).

- Observation and fields of fire.
- Cover and concealment.

- Obstacles.
 - Key terrain.
 - Avenues of approach.
- (3) Enemy forces.
- Identification.
 - Composition/order of battle.
 - Recent activities.
 - Strength/weaknesses.
 - Current location.
 - Most probable course of action.

b. Friendly forces.

- Brigade mission and commander's intent.
- Task force/squadron mission and commander's intent.
- Task force/squadron commander's concept of the operation.
- Adjacent unit missions/locations.
- Unit(s) providing fire support.
- Other units supporting the task force/squadron.

PARAGRAPH 2 - MISSION

PARAGRAPH 3 - EXECUTION

Commander's intent.

a. Concept of the operation.

(1) Scheme of maneuver.

- Offensive operations.
 - Passage of lines.
 - Axis or route.
 - Movement formations.
 - Movement techniques.
 - Actions on contact (prior to the objective)
 - Actions at obstacles.
 - Actions on the objective (decisive point).
 - Consolidation and reorganization.
 - On-order and be-prepared missions.
- Defensive operations.
 - Security operations.
 - Passage of lines of forward forces.
 - Battle handover.
 - Defense of initial and successive BPs.

- Displacement.
- Counterattack.
- Consolidation and reorganization.

(2) Fires.

- Purpose of indirect fires.
- Priority of fires.
- Allocation, including use of special fires (such as smoke, illumination, or cas).
- Triggers.
- Restrictions/coordinating instructions.

(3) Engineer support.

- Priority of effort.
- Priority of support.

b. Tasks to maneuver units.

(1) Task for each of the platoon's sections/squads.

(2) Purpose for each of the platoon's sections/squads.

c. Tasks to combat support units.

(1) Engineers.

(2) ADA.

d. Coordinating instructions.

(1) Movement instructions.

- SP/RP time and location.
- Order of march.
- Movement route.
- RP time and location.
- Limit of advance (attack position, tactical assembly area, or other control measure).

(2) Passage of lines.

- Linkup time and location.
- Passage point/passage lane locations.

(3) Priority intelligence requirements (PIR).

(4) Troop safety.

- Exposure guidance (in cGy).

- MOPP level(s) and initiation times.
- Direct fire weapons control status and warnings.
- ADA weapons control status and warnings.

PARAGRAPH 4 - SERVICE SUPPORT

a. Concept of support.

- Current location of task force/squadron combat field trains.
- Current location of task force/squadron UMCP.
- Current location of task force/squadron aid station(s).
- Scheme of support.

b. Materiel and services.

(1) Supply.

- Class I.
- Class III.
- Class V.
- Class IX.

(2) Transportation.

- Location of task force/squadron supply route.
- Location of LRPs and collection points.
- Priority of movement on task force/squadron MSR.

(3) Service.

- Location of mortuary services.
- Procedures for evacuation of KIA personnel.

(4) Maintenance.

- Location of UMCP during the battle.
- Method of marking damaged vehicles.
- Task force/squadron recovery plan.

c. Medical evacuation and hospitalization.

- Location of task force/squadron aid station(s) during the battle.
- Method of marking vehicles carrying WIA/KIA personnel.
- Procedures for evacuation of WIA/KIA personnel.

d. Personnel.

- Procedures for handling EPWs.
- Location of task force/squadron EPW collection point.

- Personnel replacement.
- e. Civil/military cooperation.
- Curfews.
 - Collateral damage restrictions.

PARAGRAPH 5 - COMMAND AND SIGNAL

- a. Command.
- Location of platoon leader and PSG.
 - Location of task force/squadron commander.
 - Location of task force main CP/squadron TAC CP.
 - Succession of command.
- b. Signal.
- SOI in effect.
 - Radio communications restrictions.
 - Radio listening silence and the time it is in effect.
 - Alternate frequencies and time or condition for changing frequency.
 - Visual and pyrotechnic signals.
 - During passage of lines.
 - During movement.
 - During breaching operations.
 - On the objective.
 - During defensive operations.
 - Emergency signals.
 - Code words and reports specific to the operation.
 - Electronic protection, including COMSEC guidelines and procedures.

Figure A-1. Sample scout platoon OPOD format.

SECTION 3 — FRAGMENTARY ORDERS

The FRAGO is a brief oral or written order that serves to update or clarify a previous order. During the execution of an operation, FRAGOs are the medium of battle command. The company team commander uses them to communicate changes in the enemy or friendly situation and to retask his subordinate elements based on changes in the situation. FRAGOs can serve any of the following purposes:

- Implement timely changes to existing orders.
- Provide pertinent extracts from more detailed orders.
- Provide instructions until a detailed order is developed.

- Provide specific instructions to subordinates who do not require a complete order.

The content of each FRAGO will depend on the specific operational and tactical situation. In general, scout platoon FRAGOs will include the following information:

- Updated enemy or friendly situation.
- Mission (ensure platoon tasks and purpose are clear).
- Scheme of maneuver.
- Specific instructions as necessary.

APPENDIX B

Nuclear, Biological, and Chemical Operations

Because many potential adversaries have the capability to employ biological, chemical, and nuclear weapons, scouts must prepare to fight in an NBC environment. Collecting, processing, and disseminating needed NBC hazard information is also vital. To survive and remain effective on the integrated battlefield, the scout platoon must be proficient in the three fundamentals of NBC defense: contamination avoidance, NBC protection, and decontamination.

Additional-duty NBC personnel should be designated by the platoon SOP for operations in an NBC environment. The crews of the section leaders' vehicles should be designated and trained as chemical agent detection and radiological survey and monitoring teams. The squad leaders' crews should be designated as decontamination teams and trained to operate all decontamination equipment organic to the battalion or squadron.

CONTENTS

[Section 1 Contamination Avoidance](#)

[Section 2 NBC Protection](#)

[Section 3 Decontamination](#)

[Section 4 Reconnaissance and Security in an NBC Environment](#)

SECTION 1 — CONTAMINATION AVOIDANCE

Avoidance is the most important fundamental of NBC defense because the best way to survive is to avoid being the object of an NBC attack. Avoiding contaminated areas minimizes the risk of additional casualties and the degradation of combat power caused by operating in MOPP level 3 or 4 for extended periods of time. In addition, the unit is not required to spend the time and resources needed for decontamination. Contamination avoidance measures include using passive avoidance measures, locating contaminated areas, identifying NBC agents, warning other members of the platoon as well as other units, and reporting NBC threats to higher headquarters. If the tactical situation does not allow avoidance, the unit must be prepared to operate in a contaminated environment.

Passive avoidance measures can decrease the possibility of NBC attack or reduce the effects of an attack

already under way. Effective use of concealment, dispersion, prepared positions, OPSEC, and signal security lessen the chances of being acquired as a target. The scout platoon should continually analyze its vulnerability to NBC attack and take appropriate protective measures.

Attacks and contamination must be detected quickly and reported to adjacent units and headquarters elements. The scout platoon must have an effective method of quickly passing the alarm in the event of an NBC attack. The alarm can be passed by radio, audible signals, or hand-and-arm signals. The SOP should specify automatic procedures for employing detection teams and submitting the required NBC reports after an NBC attack or when contamination is encountered.

All movement routes and future positions should be reconnoitered for nuclear and chemical contamination whenever possible. Reconnaissance and quartering parties should be prepared to encounter, detect, identify, report, and mark contamination. By finding the location and type of hazard (nuclear radiation or chemical agent), the scout platoon can determine the best plan for bypassing, crossing, or operating in the hazard. The platoon must be prepared to locate and evaluate the hazard based on available information from fallout predictions (simplified and detailed), chemical downwind hazard predictions, monitoring data, and contamination overlays. Based on the situation, the platoon leader and parent unit commander must be able to implement protective measures specified in the SOP to minimize personnel losses and limit the spread of contamination.

DEFENSE BEFORE A NUCLEAR ATTACK

The best defense against a nuclear attack is to dig in. Unit defensive positions, which vary from individual foxholes to improved positions, should be prepared whenever the tactical situation permits.

Scouts should keep their individual weapons, equipment, clothing, and other issue items in their vehicles. Equipment must be secured because the blast wave will convert unsecured items into lethal missiles. Supplies, explosives, and flammable materials should be dispersed and protected.

Reverse slopes of hills and mountains give some nuclear protection. The initial radiation and the heat and light from the fireball of a nuclear blast tend to be absorbed by hills and mountains. Use of gullies, ravines, ditches, natural depressions, fallen trees, and caves can reduce nuclear casualties.

BIOLOGICAL DEFENSE

The key protective measure against a biological attack is maintaining a high order of health, personal hygiene, and sanitation discipline. Biological attacks are hard to detect. If an attack occurs, chances of survival are better if crewmembers are healthy and physically fit and maintain good personal hygiene. Keeping the body clean helps to prevent ingestion of biological agents. Keep small cuts or scratches covered and germ-free by using soap, water, and first-aid measures. Since insects carry biological agents, prevent insect bites by keeping clothes buttoned and covering the skin.

Do not eat food or drink water that may be contaminated. After an attack, you must assume that all surfaces have been exposed to germs. Eat or drink only food that has remained sealed; consume it only after you have washed and cleaned the outside of the container. All water must be boiled at least 15 minutes.

DEFENSE BEFORE A CHEMICAL ATTACK

Protective procedures

Make sure all personnel have their protective masks available, and make sure each mask fits and functions properly. All personnel should wear the proper protective clothing in accordance with the MOPP level designated by the commander. Protect all equipment and supplies from liquid chemical contamination by keeping them organized and covered.

Emplacing the M8A1 automatic chemical agent alarm

The M8A1 is the primary means of detecting an upwind chemical attack. The system provides two essential elements of survival: detection of a toxic agent cloud and early warning to troops in the monitored position. The platoon leader decides where to place the chemical alarm. The detector units should be placed no more than 150 meters from the platoon's perimeter or position. Space the available detector units approximately 300 meters apart, and make sure each detector unit is connected to the alarm unit by telephone cable (WD-1). Position the alarm units near radiotelephone assets; this makes it easy to alert the unit of an attack. Blowing sand or dust, rain, sleet, snow, temperatures below 40 degrees Fahrenheit, and tropical conditions can affect operation of the alarm.

SECTION 2 — NBC PROTECTION

If an NBC hazard cannot be avoided, the scout platoon must be prepared to protect personnel and equipment from the effects of exposure. The type and degree of protection required will be based on the unit's mission and the hazard. Note that the line between contamination avoidance and protection is not distinct; many actions contribute equally to both.

MOPP LEVELS, ALARMS, AND SIGNALS

Soldiers on the integrated battlefield will face a combination of nuclear, biological, chemical, and conventional attacks. The key to effective protection in an NBC environment is the scout platoon's proficiency in automatically and correctly implementing an effective NBC defense SOP. Individual and unit protection against chemical attack or contamination hinges on effective use of the MOPP and on individual proficiency in basic NBC skills. All platoon members must be familiar with the standard MOPP levels shown in [Table B-1](#).

Table B-1. MOPP levels and equipment requirements.

MOPP level	MOPP READY	MOPP 0 (ZERO)	MOPP 1	MOPP 2	MOPP 3	MOPP 4	Command (mask only)
Equipment							
Mask	Carried	Carried	Carried	Carried	Worn <u>1</u>	Worn	Worn
Overgarment	Ready <u>3</u>	Available <u>4</u>	Worn <u>1</u>	Worn <u>1</u>	Worn <u>1</u>	Worn	
Vinyl overboots	Ready <u>3</u>	Available <u>4</u>	Available <u>4</u>	Worn	Worn	Worn	

Gloves	Ready ³	Available ⁴	Available ⁴	Available ⁴	Available ⁴	Worn	
Helmet protective cover	Ready ³	Available ⁴	Available ⁴	Worn	Worn	Worn	
Chemical protective undergarment ²	Ready ³	Available ⁴	Worn ²	Worn ²	Worn ²	Worn ²	

- 1 In hot weather, coat or hood can be left open for ventilation.
 2 The chemical protective undergarment is worn under the BDU (this primarily applies to armor vehicle crewmen and special operations forces).
 3 These items must be available to the soldier within two hours, with a second set available within six hours.
 4 These items must be positioned within arm's reach of the soldier.

When an NBC attack is recognized, every soldier must receive the warning and assume the appropriate MOPP level (see [Table B-1](#)). Those in immediate danger need warnings they can see or hear. The alarm or signal must be simple and unmistakable for quick and correct reaction. Units not immediately affected need the information to prepare for the hazard or to change plans.

If an NBC hazard has been located, the contaminated area should be marked. The NBC warning and reporting system (NBCWRS) and contamination markers contribute to the warning procedures for follow-on forces. In the immediate area of contamination, several methods (or a combination of methods) will allow quick reaction by all platoon members. These methods include vocal alarms (shout of "GAS"), the M8A1 alarm, nonvocal alarms (horn blast or banging of metal-to-metal objects), and visual alarms (most commonly, hand-and-arm signals). The tactical situation may not allow for audible alarms; therefore, the platoon SOP should clearly detail the visual signals for contamination.

DEFENSE DURING A NUCLEAR ATTACK

Dismounted defensive actions

Never run for cover! Immediately drop flat on the ground (face down) or to the bottom of a foxhole, with head toward the blast. Cover exposed skin as much as possible. Close your eyes. Remain down until the blast wave has passed and debris has stopped falling. Stay calm, check for injury, check weapons and equipment for damage, and prepare to continue the mission.

Mounted defensive actions

As time permits, mounted scouts take the following actions:

- Position the vehicle with the front slope facing the blast and the main weapon system pointed away from the blast.
- Lock the brakes.
- Secure loose equipment inside the vehicle to prevent injuries and equipment damage.
- Secure all exterior components that could be damaged by the blast (such as water cans, duffel bags, and antennas) inside the vehicle.

- Turn off all radios as well as turret and master power.
- Close and lock all hatches, including ballistic shields.
- Wear the proper helmet and eye protection.
- Stow TOW weaponry and equipment, if applicable.

NOTE: HMMWV-mounted scouts should exit and move away from the vehicle, then take dismounted defensive actions.

DEFENSE AFTER A NUCLEAR ATTACK

Once the attack ends, forward an NBC-1 nuclear report, organize the survivors, secure and organize equipment, repair and reinforce the BP, assist casualties, improve protection against possible fallout, and begin continuous monitoring. If the radiation dose rate reaches a hazardous level after fallout is complete, be prepared to move, on order, to a less hazardous area.

Fallout warning

The first person to detect the arrival of fallout is usually the radiological monitor operating a radiacmeter. As soon as he notes a dose rate of 1 centigray per hour (cGy/hr) or higher, he warns unit personnel. All personnel hearing the warning relay it to others. If the mission allows, soldiers should move into a shelter with overhead cover and stay there until given an "ALL CLEAR" signal or until otherwise directed to move. If the mission does not allow the unit to take cover, decontamination becomes more important and perhaps more difficult.

Supervision of radiological monitoring

Radiological monitoring is performed routinely to determine the presence and intensity of a radiation hazard. It is conducted using the IM-174 or AN/VDR-2 radiacmeter. Scout leaders must ensure that their scouts are properly trained on this equipment. There are two types of monitoring, periodic and continuous.

Periodic monitoring assures the platoon that the area is not contaminated or, if applicable, provides a warning when contamination is detected after the platoon arrives. Readings are taken once every hour. Periodic monitoring is initiated under these conditions:

- After first use of nuclear weapons in theater.
- When the platoon is out of contact with higher headquarters.
- When ordered by higher headquarters.
- When the platoon stops continuous monitoring.

Continuous monitoring is the surveillance for radiation in the platoon's area or position. Continuous monitoring will be initiated when any of the following situations occur:

- When a nuclear detonation is observed or reported in the area of operations.
- When an NBC-3 report is received and the platoon is in the predicted area of contamination.
- When ordered by higher headquarters.
- When a dose rate of 1 cGy/hr is recorded in periodic monitoring.

Supervision of tactical dosimetry operations

A scout platoon is normally issued two dosimeters. Select two soldiers, usually one from the vehicle of each section leader, to wear them. Check all dosimeters to be used for the operation; any that do not read zero should be turned in for recharging. If a charger is not available, note the original reading. Make sure dosimeter readings are reported accurately. Collect readings at least once daily. Average these readings, round to the nearest 10, and report this average and the radiation exposure status (RES) to higher headquarters.

When operating in or crossing radiologically contaminated areas, use the individual actions for nuclear defense. Vehicles should be closed tightly; cargoes should be covered by tarps or tenting. Mission permitting, speed should be kept down to prevent dust, and vehicles should maintain adequate following distances to stay out of the dust raised by preceding vehicles.

After the unit exits a contaminated area, personnel, equipment, and cargo should be checked for contamination and decontaminated, if necessary. Dose rates should be monitored closely to ensure compliance with operational exposure guidance (OEG). The RES should be updated, if appropriate.

DEFENSE DURING A CHEMICAL ATTACK

Give the alarm. Have all unmasked soldiers put on their protective masks and other MOPP gear. All personnel should move inside their vehicles and close all hatches (if applicable); this will aid in the protection from gross liquid contamination. The platoon leader directs use of M256 detector kits to determine the type of agent and submits an NBC-1 report. The platoon then continues the mission.

DEFENSE AFTER A CHEMICAL ATTACK

Forward an NBC-1 chemical report, treat casualties, perform emergency decontamination as required, and mark the contaminated area.

SYMPTOMS AND TREATMENT OF NBC CASUALTIES

Potential adversaries may have access to a wide variety of biological agents and chemical agents on the modern battlefield. These agents can be dispensed alone or with other carriers or agents. Casualties resulting from exposure to biological or chemical agents require medical treatment as quickly as possible.

The first step in the treatment process is usually appropriate self-aid and buddy-aid measures. These vary depending on the agent. Soldiers should first mask to prevent them from either inhaling or ingesting additional agents; then they should remove agents from exposed skin, either by washing with soap and water or by using the M291 kit. Soldiers use buddy-aid procedures to observe each other for early symptoms of toxic exposure and to request medical assistance.

The platoon leader should select separate casualty collection points for both contaminated and noncontaminated casualties to prevent cross-contamination. All contaminated casualties should be decontaminated as thoroughly as the situation allows before being evacuated. The platoon must include in its casualty evacuation request the number of contaminated patients; this will allow the evacuation

team to send the proper number of vehicles for pickup.

Chemical agents fall into four major categories: nerve, blister, blood, and choking. Their primary routes of attack on the body are through the respiratory system and the skin. These agents are especially dangerous because they can kill or incapacitate quickly. The first, and most important, step in dealing with them effectively is to recognize symptoms so proper treatment can be administered. [Table B-2](#) lists protection and detection measures, symptoms, and treatment and decontamination procedures for chemical agents.

Table B-2. Chemical agent protection procedures.

AGENT TYPE	NERVE	BLISTER	BLOOD	CHOKING
Protection	Protective mask and suit	Protective mask and suit	Protective mask	Protective mask
Detection	M8A1, M256A1, CAM, M8/M9 paper	M256A1, M8/M9 paper, CAM	M256A1	Odor only (resembles new-mown hay or green corn)
Symptoms	Difficult breathing, drooling, nausea, vomiting, convulsions, blurred vision	Burning eyes, stinging skin, irritated nose (no symptoms with mustard or nitrogen mustard)	Convulsions and coma	Coughing, choking, nausea, headache, tightness in chest
Effects	Incapacitates	Blisters skin and damages respiratory tract	Incapacitates	Floods and damages lungs
First aid	Mark 1 NAAK, CANA	Same as for second- and third-degree burns	NONE	Avoid movement and keep warm
Decontamination	Use M291 kit and flush eyes with water	Use M291 kit and flush eyes with water	NONE	NONE

MARKING CONTAMINATION

Contamination must be marked so unsuspecting personnel will not be exposed to it. When platoon detection, monitoring, or reconnaissance teams detect or suspect NBC hazards, they mark all likely entry points into the area and report the contamination to higher headquarters.

The only exception to this policy occurs when marking the area would help the enemy. If this exception is made by the commander, the hazard must still be reported to protect friendly units.

Marking procedures

Markers should always face away from the contamination. For example, if markers are placed on the edge of a contaminated area to mark a radiological hot spot, they face away from the point of the highest contamination reading. Markers are placed at roads, trails, and other likely points of entry. When time and mission permit, additional markers should be emplaced. The distance between signs varies. In open terrain, they can be placed farther apart than in hilly or wooded areas. Soldiers should be able to stand in front of a marker and see the markers to the left and right of it.

Units discovering a marked contaminated area do not have to conduct elaborate, time-consuming surveys. The new unit checks the extent of contamination and alters its plans, if necessary. If the size of the hazard has either expanded or decreased, they relocate the signs. If the hazard is gone, they remove the signs. Changes are reported to higher headquarters.

Types of markers

US forces use standard NATO markers to make it easier for allies to recognize the hazards (see [Figure B-1](#)). These markers are in the standard NBC marking set. Colors and inscriptions on a marker indicate the type of hazard. Other contamination information is written on the front of the sign.

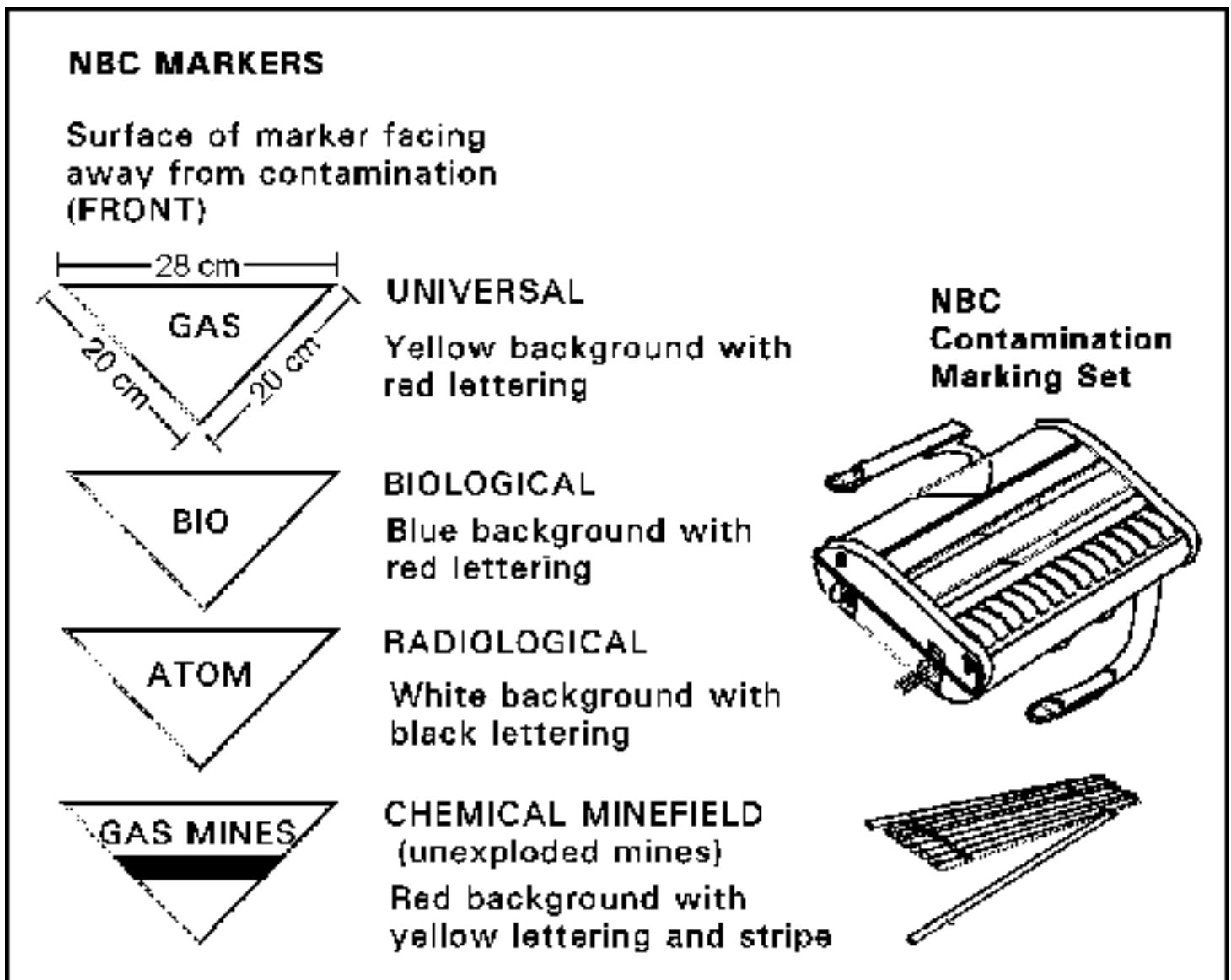

Figure B-1. NBC marking devices.

UNMASKING PROCEDURES

Soldiers should unmask as soon as possible except when a biological or chemical attack is expected. Use the procedures outlined in the following paragraphs to determine if unmasking is safe.

If an M256/M256A1 detector kit is available, use it to supplement unmasking procedures. The kit does not detect all agents; therefore, proper unmasking procedures, which take approximately 15 minutes, must still be used. If all tests with the kit (including a check for liquid contamination using M8 detector paper) have been performed and the results are negative, use the following procedures:

- The senior person should select one or two soldiers to start the unmasking procedures. If possible, they move to a shady place; bright, direct sunlight can cause pupils in the eyes to constrict, giving a false symptom.
- The selected soldiers unmask for 5 minutes, then clear and reseal their masks.
- Observe the soldiers for 10 minutes. If no symptoms appear, request permission from higher headquarters to signal "ALL CLEAR."

- Watch all soldiers for possible delayed symptoms. Always have first-aid treatment immediately available in case it is needed.

If an M256/M256A1 kit is not available, the unmasking procedures take approximately 35 minutes. When a reasonable amount of time has passed after the attack, find a shady area; use M8 paper to check the area for possible liquid contamination. Conduct unmasking using these procedures:

- The senior person selects one or two soldiers. They take a deep breath and break their mask seals, keeping their eyes wide open.
- After 15 seconds, the soldiers clear and reseal their masks. Observe them for 10 minutes.
- If no symptoms appear, the same soldiers break the seals, take two or three breaths, and clear and reseal their masks. Observe them for 10 minutes.
- If no symptoms appear, the same soldiers unmask for 5 minutes, then remask.
- If no symptoms appear in 10 minutes, request permission from higher headquarters to signal "ALL CLEAR." Continue to observe all soldiers in case delayed symptoms develop.

ALL-CLEAR SIGNAL

The all-clear signal is given by word of mouth through the chain of command. It is initiated by higher headquarters after testing for contamination proves negative. If required, standard sound signals may be used, such as a continuous, sustained blast on a siren, vehicle horn, or similar device. When "ALL CLEAR" is announced on the radio, it must be authenticated before compliance. The commander designates the specific all-clear signal and includes it in his SOP.

WARNING AND REPORTING SYSTEMS

The NBCWRS is a rapid means of sending reports of an NBC attack. The reports inform other affected units of clean areas and possible contamination. They are also used to report contaminated areas up and down the chain of command and to adjacent units. Each report has a specific purpose and uses standard codes to shorten and simplify the reporting process. Refer to [FKSM 17-98-3](#) for the formats and letter codes of standard NBC reports. The scout platoon's priority should be to pass detailed information, in the form of SPOTREPs, to the battalion/squadron NBC NCO. The platoon NBC NCO should then send the proper NBC report to higher headquarters.

SECTION 3 — DECONTAMINATION

Since continued operation in the presence of nuclear or chemical contamination will cause casualties and severe combat degradation, decontamination is essential. To get the maximum benefit of the time and resources available, the scout platoon should conduct decontamination using the following guidelines:

- Conduct it as soon as possible.
- Conduct it only to the extent necessary to ensure safety and operational readiness.
- Conduct it as far forward as possible.
- Conduct it by priority.

These principles are consistent with doctrine that places the burden of decontamination at battalion or troop level. For this reason, the scout platoon must use all of the available decontamination assets to maximum benefit and develop a thorough SOP covering decontamination methods and priorities. Refer to [FM 3-5](#) for more detailed information on NBC decontamination.

IMMEDIATE DECONTAMINATION

Immediate decontamination is a basic soldier survival skill carried out by soldiers as soon as possible after they discover they are contaminated. Its basic purposes are to minimize casualties, save lives, and limit the further spread of contamination. Any contact between chemical or biological agents and bare skin should be treated as an emergency. Some agents can kill if they remain on the skin for longer than a minute. The best technique for removing or neutralizing these agents is to use the M291 skin decontamination kit. Leaders must ensure that their soldiers are trained to execute this technique automatically, without waiting for orders.

Personal wipedown should begin within 15 minutes of contamination. The wipedown removes or neutralizes contamination on the hood, mask, gloves, and personal weapon. For chemical and biological contamination, soldiers use mitts from the M295 individual equipment decontamination kit (IEDK). For radiological contamination, they wipe off the contamination with a cloth or simply brush or shake it away.

Operator's spraydown of equipment should begin immediately after completion of personal wipedown. The spraydown removes or neutralizes contamination on the surfaces operators must touch frequently to perform their mission. For chemical and biological contamination, operators can use on-board decontamination apparatuses, such as the M11/M13, or the M295 IEDK to decontaminate surfaces to which DS2 cannot be applied. (**NOTE:** DS2 must be washed off surfaces no more than 30 minutes after application. If necessary, use 5-gallon water cans or other water sources to assist in removing DS2.) For radiological contamination, they brush or scrape away the contamination with whatever is at hand or flush it with water and wipe it away.

OPERATIONAL DECONTAMINATION

Operational decontamination allows a force to continue fighting and sustain its mission after being contaminated. It limits the hazard of transferring contamination by removing most of the gross contamination on equipment and nearly all the contamination on soldiers. This speeds the weathering process and allows clean areas (people, equipment, and terrain) to stay clean. Following operational decontamination, soldiers who have removed sources of vapor contamination from their clothing and equipment can use hazard-free areas to unmask temporarily to eat, drink, and rest.

Operational decontamination is accomplished using assets of the parent unit. It makes use of two decontamination techniques: vehicle washdown and MOPP gear exchange. These procedures are conducted at the same time and are best performed at squad level. Vehicles and personnel that are not contaminated should not go through either technique.

Vehicle washdown, conducted as far forward as possible, is performed by the task force power-driven decontamination equipment (PDDE) crew with assistance from the squad decontamination crew. It is most effective if started within 1 hour after contamination. There are two steps in vehicle washdown:

- **Step 1.** Button up the vehicle and secure equipment.
- **Step 2.** Wash down the vehicle and equipment with hot, soapy water for 2 to 3 minutes.

Because speed is important, do not check vehicles for contamination after vehicle washdown. Remove only gross contamination.

THOROUGH DECONTAMINATION

Thorough decontamination reduces contamination to negligible risk levels. It restores combat power by removing nearly all contamination from unit and individual equipment. This allows troops to operate equipment safely for extended periods at reduced MOPP levels. A contaminated unit conducts detailed troop decontamination (DTD) under supervision of the chemical unit. Ordinarily, the chemical unit selects a site, sets it up, and performs the detailed equipment decontamination (DED) with assistance from the contaminated unit. A small risk from residual contamination remains, so periodic contamination checks must be made after this operation.

Thorough decontamination is conducted as part of an extensive reconstitution effort in brigade, division, and corps support areas; support sites at lower levels cannot provide the quantities of decontamination resources (such as water, decontaminants, and time) required for such an extensive process. In some cases, a contaminated unit could conduct a thorough decontamination operation with organic decontamination assets, but support from a chemical unit is usually required.

After thorough decontamination, the unit moves into an adjacent assembly area for reconstitution. Support elements from the brigade, division, or corps support areas replenish combat stocks, refit equipment, and replace personnel and equipment. The newly reconstituted unit leaves the assembly area fully operational and fit to return to battle.

Thorough decontamination does the most thorough job of getting rid of contamination and its hazards, but it often is not possible. It requires large quantities of valuable resources that may not be immediately available. The next best solution is to decontaminate only what is necessary to sustain the force and continue to fight.

SECTION 4 — RECONNAISSANCE AND SECURITY IN AN NBC ENVIRONMENT

In an ideal situation, all NBC reconnaissance will be performed by an NBC reconnaissance platoon. Given the very limited number of these platoons available and the likelihood of chemicals being used on the battlefield, the scout platoon not only must be able to perform its own missions in a contaminated environment, but also must have the capability of conducting NBC reconnaissance.

RELATIONSHIP OF THE NBC RECONNAISSANCE ELEMENT AND THE SCOUT PLATOON

The NBC reconnaissance platoon, particularly in the division and cavalry regiment, often works closely with either battalion or cavalry scout platoons. When the two organizations are working together, their capabilities should be used to complement each other. The command relationship between the platoons,

which should be based on METT-TC factors, can be one of the following:

- The scout platoon OPCON to the NBC reconnaissance platoon.
- The NBC reconnaissance platoon OPCON to the scout platoon.
- The two platoons working together under the control of a common commander.

As an example, if the primary focus of the platoons' reconnaissance mission is to locate contaminated areas, the NBC reconnaissance platoon leader may be selected to lead the operation. On the other hand, the scout platoon leader may be selected to lead and coordinate the mission if enemy presence is significant, if extensive dismounted operations are anticipated, or if the mission is oriented on the enemy force.

In all cases when the two types of platoons are operating together, the NBC platoon's primary task should be NBC reconnaissance. The scout platoon has capabilities for which it is better equipped or organized; it should perform tasks related to those capabilities, such as the following:

- Overwatch and security for NBC reconnaissance elements.
- Dismounted operations in concert with NBC reconnaissance.
- Reconnaissance of bypasses once a contaminated area is identified.
- Initial location of contaminated areas, followed by handoff to the NBC reconnaissance platoon for detailed reconnaissance and marking.
- Liaison or command and control linkup between the NBC reconnaissance platoon and the commander of the scouts.

RECONNAISSANCE OPERATIONS

In the event that NBC reconnaissance assets are not available, the scout platoon may be required to conduct NBC reconnaissance. The platoon must be aware of where on the battlefield the enemy may place chemical agents and understand the impact on maneuver forces if that area is contaminated. The scout platoon must be aware of the large volume of munitions required to place a chemical strike on the ground. Understanding the enemy's doctrine will allow the scout platoon to quickly report potential contamination, allowing commanders to make timely critical decisions.

Crossing a contaminated area

As with other combat elements, one of the basic requirements for the scout platoon is to be able to move tactically across a contaminated area. Upon identifying a contaminated area, each scout section makes preparations to cross. While one vehicle provides security, the other vehicle, positioned in a covered and concealed location, removes all externally stowed equipment. The crew mounts and tests M8A1 alarms and M9 paper. The crew adopts MOPP level 4. Once preparations are complete, the vehicle moves into an overwatch position; the other vehicle moves to a covered and concealed position and follows the same procedures.

When both vehicles have been prepared, they use standard tactical movement techniques (such as bounding overwatch) to cross the contaminated area. During this movement, the driver's and gunner's hatches remain closed, and the crew continuously monitors the M8A1 alarm and the M9 paper. As much as possible, drivers and vehicle commanders attempt to avoid low ground, overhanging branches, and

brushy areas. Dismounted operations are still conducted, but they are kept to the absolute minimum necessary to perform the mission while maintaining security. While the section is in the contaminated area, all personnel observe each other for signs of chemical poisoning.

When the section has successfully crossed the contaminated area, it temporarily halts. During this halt, each squad in turn executes operational decontamination of its vehicle and, with higher headquarters' approval, unmasking procedures. Once this is complete, the scouts continue the mission.

Detecting and marking a contaminated area

US doctrine requires that combat missions be accomplished quickly and effectively, under all conditions and at any time. One of the reasons an enemy would use persistent and nonpersistent chemicals is to cause confusion and thus slow down the tempo of friendly operations. The effectiveness of these agents can be reduced if the friendly commander knows the exact location of contaminated areas. Within a division or regiment, specialized NBC reconnaissance platoons can accomplish this; however, as noted, very few of these platoons exist. All scout platoons must therefore understand how to systematically locate and mark suspected contaminated areas.

Preparation. When assigned a mission or task to locate and mark a suspected contaminated area, the scout platoon must ensure that it prepares properly for the mission. Preparation for an NBC reconnaissance mission begins with inspection of personnel and equipment. As a minimum, each squad must have on hand the following equipment:

- M8 paper.
- M9 paper.
- M256/M256A1 detector kit.
- M8A1 alarm.
- Chemical agent monitor (CAM).
- Marking kit.
- M13 decontamination apparatus (DAP).
- M291 decontamination kit.
- MOPP gear.
- Mark 1 nerve agent autoinjector kit (NAAK).
- VS-17 marking panels.

In addition to ensuring that the proper equipment is on hand, leaders must ensure that alarms and paper are properly mounted and functional and that all external equipment is stowed. The platoon leader includes a rehearsal of NBC reconnaissance techniques in his mission preparation. The platoon leader will also coordinate with the unit chemical officer for any special instructions, ensuring that thorough decontamination support is available at the conclusion of the mission.

Movement to the contaminated area. Once mission preparation is complete, the platoon moves to the suspected contaminated area (designated as a reconnaissance objective) using movement techniques and organization appropriate to the tactical situation. As the platoon approaches the suspected objective area, it stops short and reorganizes, assuming a three-section organization.

The sections are deployed on line, with no more than 400 meters between vehicles and no more than 400 meters between sections. All elements assume MOPP 4. The platoon leader directs the platoon to close hatches and begin movement in the direction of the contaminated area.

Initiation of monitoring. The platoon moves by bounding overwatch within sections. Lead vehicles bound no more than 200 meters. As they move forward, they move slowly to avoid stirring up dust and running over or under foliage. The lead elements move to the limit of their bound, halt, and sample the soil and air for contamination. Air sampling is conducted automatically by the functioning M8A1 alarm. Ground sampling is done without dismounting, using M8 paper mounted on a stick or using the CAM. The section leaders report their results to the platoon leader; they do not proceed further without permission.

The platoon leader strictly controls the movement of the sections. If all sections report negative samples, the platoon leader gives permission for the overwatch vehicles to move up. As long as the results remain negative, the platoon continues to move in this manner through the suspected contaminated area and up to 3 kilometers beyond it. The platoon leader reports the negative results of the reconnaissance to his higher headquarters. [Figure B-2](#) illustrates initial movement for reconnaissance of a suspected area of contamination.

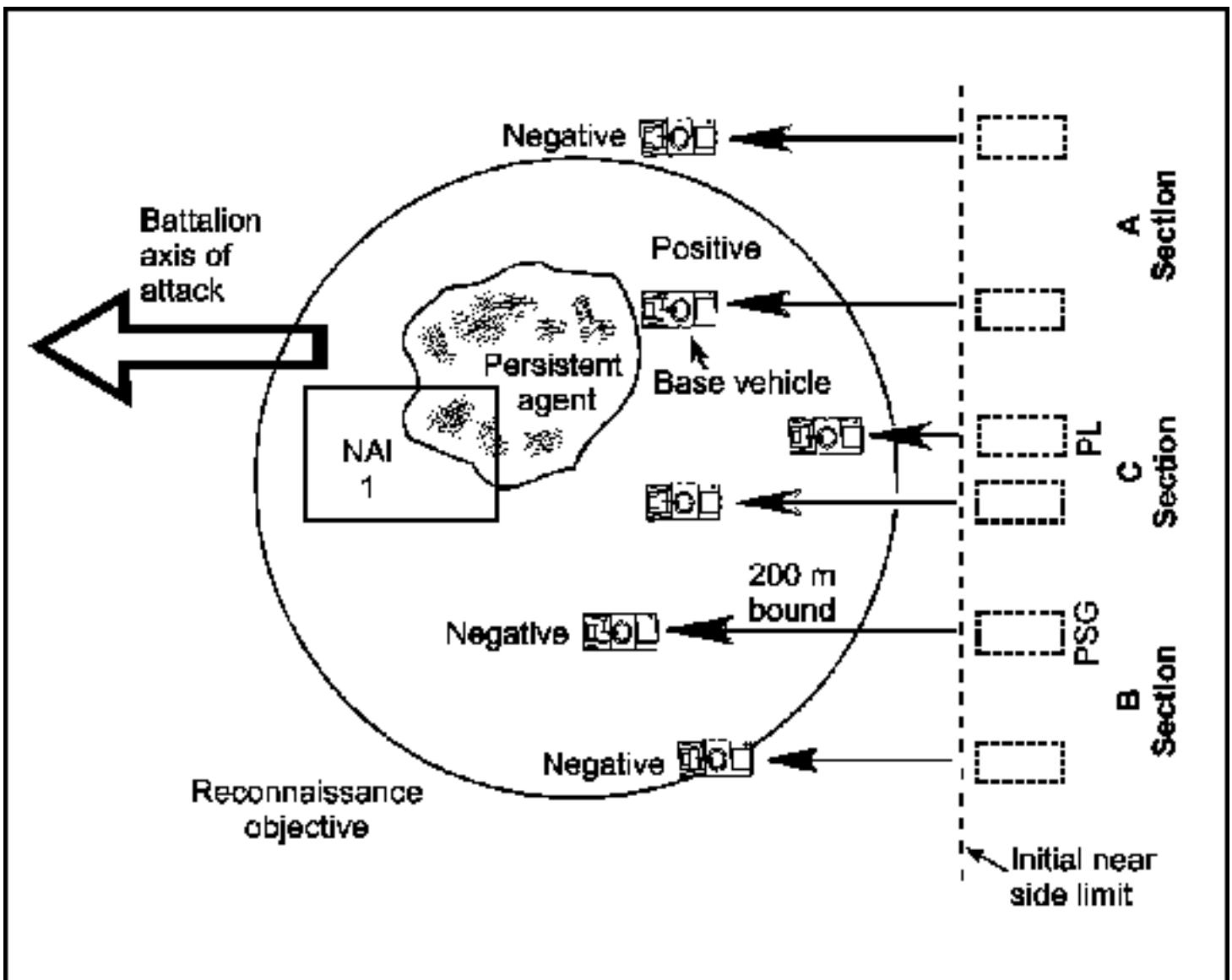

Figure B-2. Platoon movement to locate contaminated area.

Procedures when contamination is detected. If a squad makes positive contact with contamination, it immediately reports to the platoon leader. As the platoon leader sends his initial report to higher headquarters, the squad leader rechecks to confirm the positive sampling and determine the type of contamination; he sends an updated report.

Upon confirmation of the sample, the squad with the positive sample is designated by the platoon leader as the base vehicle; its direction of movement becomes the reconnaissance direction of travel. The platoon leader also designates the initial near side line from the base vehicle's last negative sample location. The platoon leader then sends an NBC-4 report to his commander. This report includes type of agent, location, and time.

Upon report of a positive sample, all elements of the platoon halt in place and await confirmation of the sample. Once this is completed, the platoon leader reorganizes the platoon to conduct reconnaissance to define the boundaries of the contaminated area. This operation requires a single three-vehicle section (organized around the base vehicle's section) that includes either the platoon leader or PSG.

Other elements of the platoon will not participate in this task; they can be used to reconnoiter a bypass, provide security, or execute other tactical missions under the control of the platoon leader or PSG. Once the platoon leader has issued a FRAGO that reorganizes the platoon, the vehicles that are no longer needed in the NBC reconnaissance make a 180-degree turn, move to a secure rally point, and reorganize for their next task.

The three-vehicle section charged with reconnoitering the contaminated area uses a line formation, with a 400-meter lateral distance between vehicles. The section, supervised by either the platoon leader or PSG, then begins a systematic reconnaissance to locate the limits of the contaminated area.

The goal of the reconnaissance is to define the contaminated area only to the degree necessary to provide the scouts' commander with the information he needs to maneuver the main body. The minimum information the commander needs is a four-sided box enclosing the contaminated area. The following discussion focuses in detail on the steps the section takes to complete the reconnaissance.

Step-by-step reconnaissance procedures. The process used to ensure that the contaminated area is completely reconnoitered is fairly complicated and requires flawless execution. Therefore, detailed rehearsals are absolutely essential. The process includes these steps:

- The reconnaissance team assumes a line formation with the base vehicle in the center.
- The base vehicle moves in bounds and takes a sample every 200 meters. The vehicle commander resets the M8A1 after every bound, if applicable.
- The base vehicle moves across the contaminated area in the direction of travel until it takes a negative sample (this establishes the baseline). When a negative sample is reported, the following actions take place:
 - The vehicle commander rechecks to verify the negative sample.
 - The base vehicle bounds 200 additional meters and takes another sample.
 - If the new sample is negative, the base vehicle halts and reports to the platoon leader or PSG.
 - If the sample is positive, the base vehicle continues until it takes two consecutive negative samples.

-- The platoon leader or PSG designates the initial far side limit at the second consecutive negative sample (refer to [Figure B-3](#)).

- Left and right wing vehicles bound and sample every 200 meters in the direction of travel until they take a positive sample or reach the initial far side limit.
- If a wing vehicle takes a positive sample, the vehicle commander rechecks the reading and reports it to the platoon leader or PSG. The following actions take place, as directed by the vehicle commander:
 - **Step A.** The driver turns 90 degrees away from the baseline, moves 200 meters, and takes a sample.
 - **Step B.** If the new sample is negative, the driver turns 90 degrees back to the direction of travel and continues to bound and sample every 200 meters until again taking a positive sample or reaching the initial far side limit. If the vehicle takes another positive sample, the vehicle commander repeats Step A.
 - **Step C.** If the new sample is positive, the driver turns 90 degrees again, now opposite the direction of travel, and then continues to bound and sample every 200 meters until taking a negative sample. If this movement takes the vehicle past the initial near side limit, the platoon leader or PSG adjusts the near side limit back through the new negative sample location. The vehicle then repeats Step A.

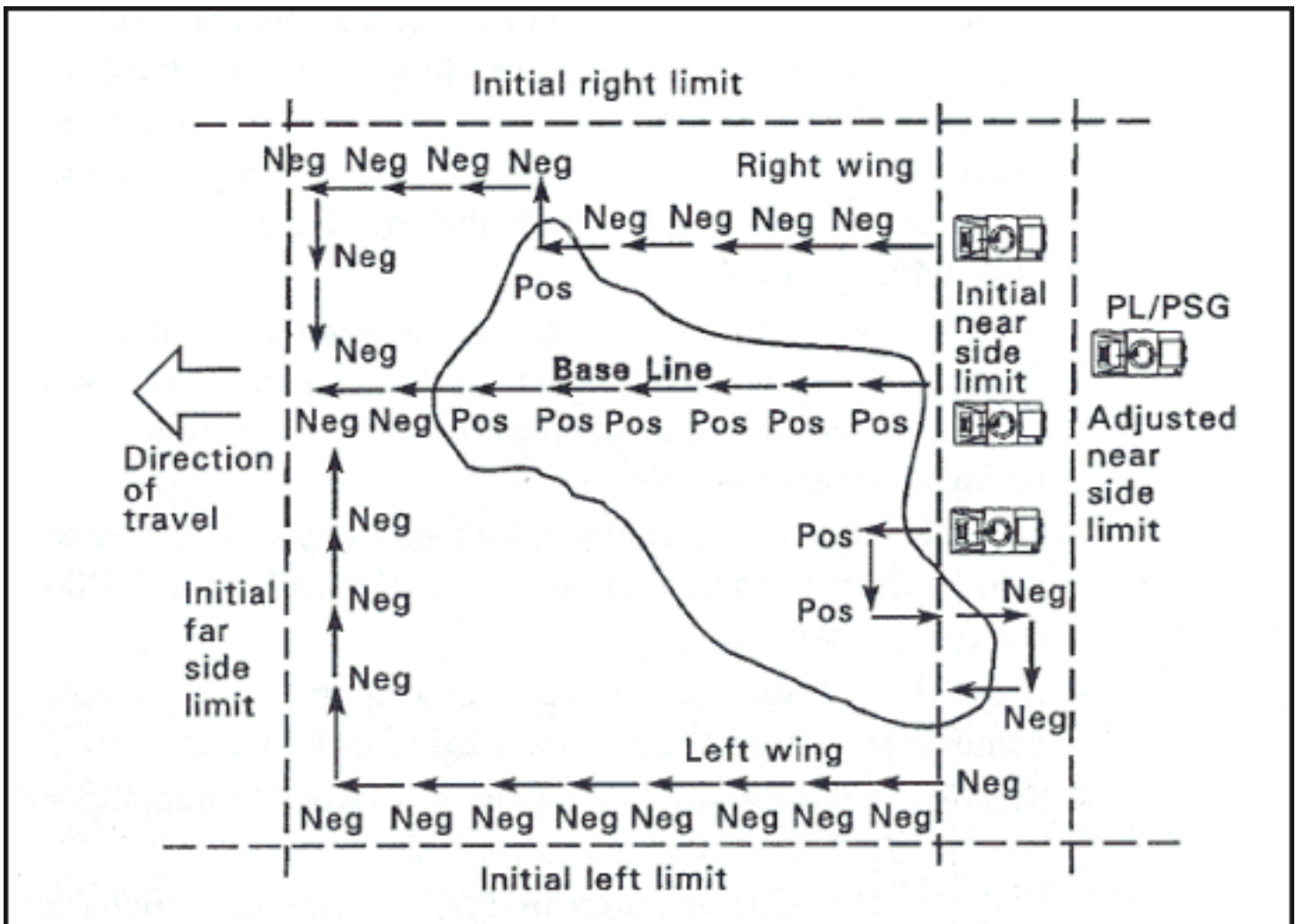

Figure B-3. Employing reconnaissance team to designate far side limit and adjust near side limit.

- Once the wing vehicles reach the far side limit, they report to the platoon leader or PSG. The following actions take place:
 - **Step A.** The platoon leader or PSG projects a line from each wing vehicle location back to the near side limit and designates these as the initial left and right limits.
 - **Step B.** The platoon leader or PSG directs wing vehicles to turn 90 degrees back toward the baseline and sample every 200 meters along the initial far side limit until reaching the base vehicle.
 - **Step C.** If all samples are negative, the reconnaissance team has boxed in the contaminated area and the reconnaissance is complete. It skips [steps D](#) through [J](#) and begins the concluding process.
 - **Step D.** If a wing vehicle takes a positive sample, the vehicle commander backs up to his last negative sample location, turns 90 degrees back in the direction of travel, moves 200 meters, and samples.
 - **Step E.** If the sample is negative, the vehicle commander repeats [steps B](#), [C](#), and [D](#) until reaching the base vehicle. In this case, the base vehicle must also bound and sample in the direction of travel for each bound of the wing vehicles. The platoon then skips [step F](#) through [J](#) and begins the concluding process.
 - **Step F.** If the sample is positive, the vehicle commander directs his driver to turn 90 degrees away from the baseline, bounds, and samples every 200 meters until taking a negative sample.
 - **Step G.** The vehicle commander then directs the driver to turn 90 degrees back in the direction of travel, bounds 200 meters, and samples
 - **Step H.** If the new sample is negative, the vehicle commander repeats the process starting with [Step B](#).
 - **Step I.** If the sample is positive, the vehicle commander repeats the process starting with [step F](#).
 - **Step J.** The platoon leader or PSG adjusts the initial far side limit and the respective initial right or left limit farther out (not in) for every bound of the wing vehicles. This process continues until the contaminated area is boxed in. The adjustment process is illustrated in [Figure B-4](#).
- **Concluding process.** Once the contaminated area is located and its limits determined, the reconnaissance team takes the following actions:
 - The platoon leader or PSG sends a follow-up NBC-4 report, including type of agent, locations of the four box corners, and time.
 - The platoon leader or PSG recommends a suitable bypass to the commander.
 - The team marks the area and bypass with appropriate tactical markings or VS-17 panels. Chem lights can be used to mark the area during periods of limited visibility.
 - The team conducts operational decontamination, if required.
 - The team may be directed to conduct a screen mission for security or to provide guides to assist in the bypass of the contaminated area.
 - If no further tasks are required of the team, it can move to a thorough decontamination site, if required.

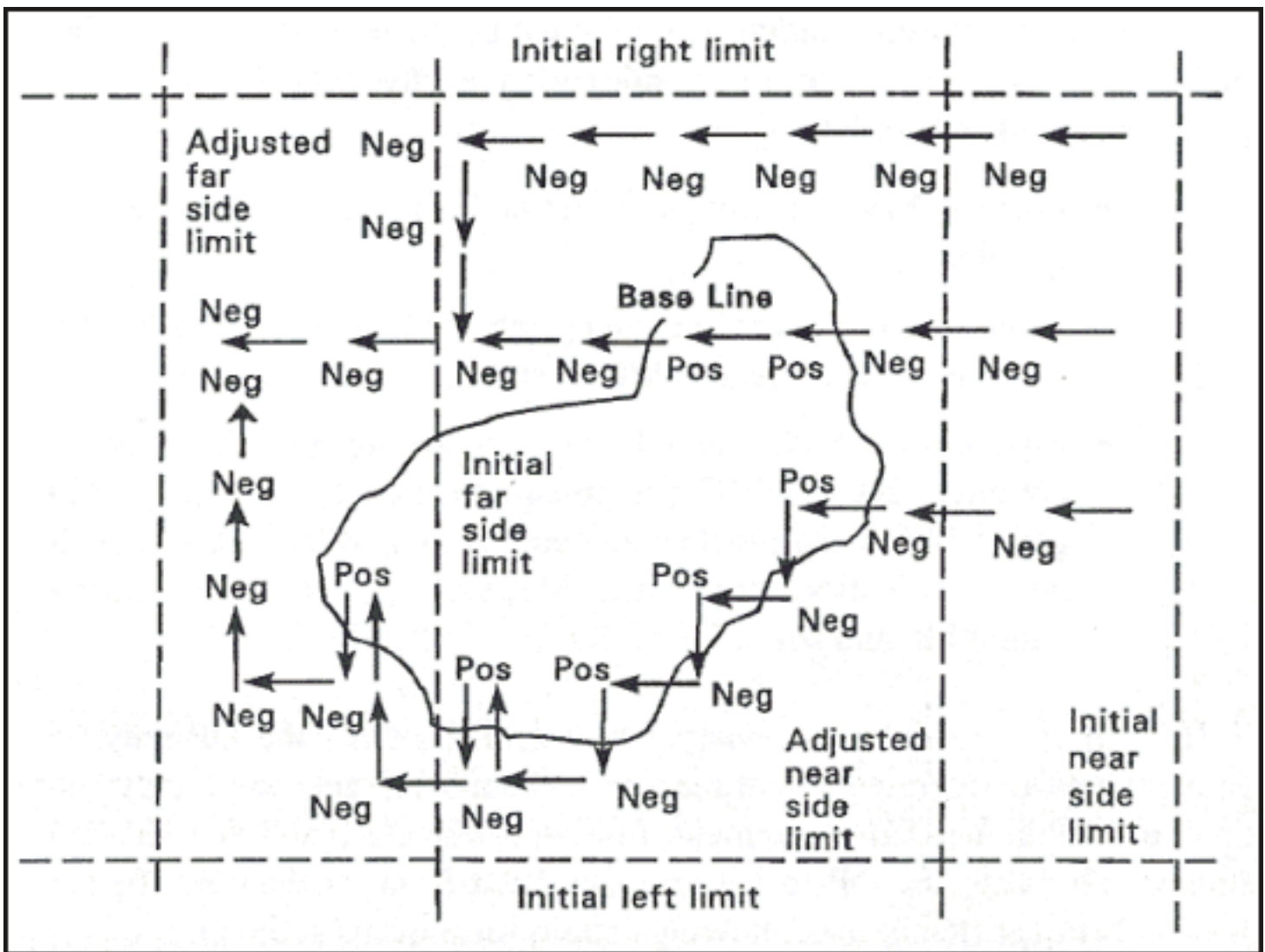

Figure B-4. Adjusting the limits of the contaminated area.

SECURITY OPERATIONS

Screen missions are not usually conducted in known contaminated areas; however, an area may become contaminated after the platoon has already occupied it. The enemy may contaminate an area with two general categories of chemicals: persistent or nonpersistent.

The use of persistent chemicals may indicate that the enemy force does not plan to move through that area; this should prompt the platoon to reposition out of the contaminated area and to begin decontamination.

The use of nonpersistent chemicals should trigger maximum alertness on the part of the scout platoon. Nonpersistent chemicals may signal that the enemy is attempting to degrade friendly combat capability prior executing an offensive action. In addition, the enemy may use nonpersistent chemicals to degrade the scouts' performance during a screen mission.

To ensure maximum readiness, OPs must be positioned and occupied in such a way that they can react quickly to a chemical attack. These preparations include the following:

- Position M8A1 alarms to cover both the OP site and the hide position.

- Ensure that soldiers occupying the OP have complete MOPP equipment regardless of MOPP status.
- Ensure that both the OP and supporting vehicles have a complete set of NBC equipment, to include M8 paper, M9 paper, M256 chemical agent detector kits, M8A1 alarms, M13 decontamination apparatus, M258A1 personal decontamination kit, and Mark I NAAKs.

These precautions are necessary for several reasons: the OP may be the first element to experience and react to a chemical attack; there may not be time to obtain needed equipment from the vehicles; and the tactical situation could cause the OP to become separated from its vehicles. In the event of a chemical attack, the following actions must occur at the OP:

- All personnel go to MOPP 4.
- All dismounted personnel, except OP teams, remount.
- Vehicles button up and start.
- Appropriate reports are sent to higher headquarters as quickly as possible.

The section leader must evaluate the situation and decide if it is appropriate to remount the OP team and move vehicles into observation positions as mounted OPs. He bases this decision on a number of factors. As a minimum, he must consider and evaluate the following:

- What is the enemy situation? Is the OP currently in contact? Is it receiving indirect fire?
- Is there effective cover and concealment for the vehicles?
- What are the visibility conditions?

Once the section leader makes his decision, he reports the recommended COA to the platoon leader and continues to execute the screen mission in accordance with the platoon plan.

APPENDIX C

Stability and Support Operations

Stability operations apply military power to influence the political environment, to facilitate diplomacy, or to interrupt or prevent specific illegal activities. These operations cover a broad spectrum. At one end are development and assistance activities aimed at enhancing a government's willingness and ability to care for its people. At the other are coercive military actions; these involve the application of limited, carefully prescribed force, or the threat of force, to achieve specific objectives.

US military forces conduct support operations to assist designated groups by providing essential supplies and services in the face of adverse conditions, usually those created by man-made or natural disasters. Mission success in support operations, which are normally characterized by the lack of an active opponent, is measured in terms of the ability to relieve suffering and to help civil authorities respond to crises. Primary goals of these operations are to meet the immediate needs of the supported groups and to transfer responsibility quickly and efficiently to appropriate civilian authorities.

CONTENTS

[Section 1](#) [General](#)

[Section 2](#) [Stability Operations](#)

[Section 3](#) [Support Operations](#)

[Section 4](#) [Role of the Scout Platoon in Stability and Support Operations](#)

[Section 5](#) [Light/Heavy Operations in Stability/Support Environments](#)

Within any military organization, scout platoons have unique capabilities that make them an important asset to Army units executing missions as part of stability and support operations. The scout platoon may be called upon to perform a variety of missions in a wide range of political, military, and geographical environments and in both combat and noncombat situations (see [Figure C-1](#)). These operations will almost always be decentralized and can require the scout platoon leader to make immediate decisions that may have strategic or operational consequences. The distinction between these roles and situations will not always be clear, presenting unique challenges for the scout platoon.

STATES OF THE OPERATIONAL ENVIRONMENT	GOALS	MILITARY OPERATIONS	MISSIONS	RECENT OPERATIONS
WAR	Fight and win	WAR	<ul style="list-style-type: none"> ● Large-scale combat operations ● Attack ● Defend 	DESERT STORM
CONFLICT	Deter war and resolve conflict	STABILITY AND SUPPORT	<ul style="list-style-type: none"> ● Strikes and raids ● Peacekeeping or peace enforcement ● Support to insurgency ● Antiterrorism ● NEOs 	RESTORE HOPE
PEACETIME	Promote peace	STABILITY AND SUPPORT	<ul style="list-style-type: none"> ● Counterdrug ● Disaster relief ● Civil support ● Peace-building ● Nation-building assistance 	HURRICANE ANDREW RELIEF

Figure C-1. The range of military operations.

The general discussion in [Section 1](#) of this appendix focuses on several important aspects of these operations. [Sections 2](#) and [3](#) examine stability operations and support operations, respectively, in greater detail, followed by a discussion of specific scout platoon tasks in [Section 4](#). [Section 5](#) provides information on the role of light/heavy operations in stability and support environments. Refer to [Appendix D](#) of this manual for a discussion of military operations on urbanized terrain (MOUT), which provide the operational framework for many types of stability and support operations.

SECTION 1 — GENERAL

Stability and support operations entail the adaptation of capabilities developed for warfighting to the political and military environments of peace and conflict. The warfighting doctrine described in this manual is used, with suitable modification, to accommodate such situations. Army policy does not prescribe modifying the warfighting METL unless and until a unit is selected for stability and support operations. Only then should a unit train for specific mission-related tasks. Chief among these are operations with very restrictive ROE and orientation on the area, its culture, and the nature of the conflict.

THE RANGE OF MILITARY OPERATIONS

Stability and support operations that take place in the peacetime and conflict environments may entail the full range of military operations. These operations may also require working closely with other state and/or federal agencies, civilian agencies, and host-nation governments if the operation is outside the United States.

Peacetime

In peacetime, a variety of measures are employed to achieve national objectives; these include political, economic, and informational measures, as well as military actions short of combat operations or active support of warring parties. Within this environment, US forces may conduct training exercises to demonstrate national resolve; conduct peacekeeping operations; participate in nation-building activities; conduct disaster relief and humanitarian assistance; provide security assistance to friends and allies; or execute shows of force. Confrontations and tensions may escalate during peacetime to reach a point of transition into a state of conflict.

Conflict

Conflict can encompass numerous types of situations, including the following: clashes or crises over boundary disputes and land and water territorial claims; situations in which opposing political factions engage in military actions to gain control of political leadership within a nation; and armed clashes between nations or between organized parties within a nation to achieve limited political or military objectives.

While regular military forces are sometimes involved, the use of irregular forces frequently predominates in conflict actions. Conflict is often protracted, confined to a restricted geographic area, and limited in weaponry and level of violence. In this state, military response to a threat is exercised indirectly, usually in support of other elements of national power. Limited objectives, however, may be achieved by the short, focused, and direct application of military force. Conflict approaches the threshold of a state of war as the number of nations and/or troops, the frequency of battles, and the level of violence increase over an extended time.

Military operations involving scout platoons occur most often in the state of conflict. These may include standard security and reconnaissance missions in support of offensive and defensive operations. The scout platoon can also assist in a variety of stability and support operations, such as populace and movement control (checkpoints and roadblocks), the handling of EPWs or refugees, or EPW exchanges.

ACTIVITIES IN STABILITY AND SUPPORT OPERATIONS

As outlined in [FM 100-5](#), the Army's missions in stability and support operations are categorized into several types of activities. Examples of these are listed in [Figure C-2](#); for additional details, refer to [Section 2](#) (stability activities) and [Section 3](#) (support activities) of this appendix.

<p>Noncombatant Evacuation Operations Arms Control Support for Domestic Civil Authorities Humanitarian Assistance and Disaster Relief Security Assistance National-building Assistance Support for Counterdrug Operations</p>	<p>Combating Terrorism Peacekeeping Operations Peace Enforcement Show of Force Support for Insurgencies and Counterinsurgencies Attacks and Raids</p>
---	---

Figure C-2. Military activities in stability and support operations.

Although the activities of stability and support operations have distinct characteristics, they often overlap in execution. For example, forces involved in a peacekeeping operation must protect themselves and the local populace against terrorism; conversely, a terrorist incident may result in the execution of a specific operation to combat terrorism.

PLANNING and OPERATIONAL CONSIDERATIONS

Although stability and support operations can take place in any part of the world, they are most likely to occur in third world countries, where social, political, economic, and psychological factors contribute to political instability. Each country or region is unique, with its own history, culture, goals, and problems. US forces deployed to these areas can be subject to rapid and dramatic changes in situations and missions. The scout platoon leader must understand this environment; he must plan for rapid changes in the situation or mission and constantly be prepared to adapt to them. In addition, scout platoons must be prepared to operate in any type of terrain and climate.

The following paragraphs examine several important considerations that will influence planning and preparation for stability and support operations. For a detailed discussion of these subjects, refer to [FM 100-23](#).

Intelligence

Intelligence is crucial during the execution of stability and support operations. Likewise, all activities require continuous emphasis on intelligence. The threats faced by military forces in these operations are more ambiguous than those in other situations because combatants, guerrillas, and terrorists can easily blend with the civilian population. Before forces are committed, intelligence must be collected, processed, and focused to support all planning, training, and operational requirements. (See [FM 100-20](#) for additional information.)

Decentralized operations

Although stability and support operations are normally centrally planned, execution often takes the form of small-scale, decentralized actions conducted over extended distances. Responsibility for making decisions on the ground will fall to junior leaders. Effective command guidance and a thorough understanding of ROE (refer to the following discussion) are critical at each operational level.

Rules of engagement

ROE are politically imposed restrictions on military operations. The ROE are directed by higher military authorities based on the political and tactical situations and the level of threat. For example, these restrictions may require that the forces involved limit their use of firepower to a certain geographical area or that they limit the duration of their operations. Refer to [Figure C-3](#) for an example of ROE for one possible situation.

All enemy military personnel and vehicles transporting enemy personnel or their equipment may be engaged subject to the following restrictions:

- . When possible, the enemy will be warned first and asked to surrender.
- B. Armed force is the last resort.
- C. Armed civilians will be engaged only in self-defense.
- D. Civilian aircraft will not be engaged, except in self-defense, without approval from division level.
- E. All civilians should be treated with respect and dignity. Civilians and their property should not be harmed unless necessary to save US lives. If possible, civilians should be evacuated before any US attack. Privately owned property may be used only if publicly owned property is unavailable or its use is inappropriate.
- F. If civilians are in the area, artillery, mortars, AC-130s, attack helicopters, tube-launched or rocket-lanched weapons, and main tank guns should not be used against known or suspected targets without the permission of a ground maneuver commander (LTC or higher).
- G. If civilians are in the area, all air attacks must be controlled by FAC or FO, and close air support, white phosphorus weapons, and incendiary weapons are prohibited without approval from division.
- H. If civilians are in the area, infantry will shoot only at known enemy locations.
 - I. Public works such as power stations, Water treatment plants, dams, and other public utilities may not be engaged without approval from division level.
 - J. Hospitals, churches, shrines, schools, museums, and other historical or cultural sites will be engaged only in self-defense against fire from these locations.
- K. All indirect fire and air attacks must be observed.
- L. Pilots must be briefed for each mission as to the location of civilians and friendly forces.
- M. Booby traps are not authorized. Authority to emplace mines is reserved for the division commander. Riot control agents can be used only with approval from division level.
- N. Prisoners should be treated humanely, with respect and dignity.
- O. Annex R to the OPLAN provides more detail. In the event this card conflicts with the OPLAN, the OPlan should be followed.

DISTRIBUTION: ONE FOR EACH SOLDIER DEPLOYED (ALL RANKS)

Figure C-3. Example rules of engagement.

ROE must be considered during the planning and execution of all operations. **The unit's TTP will require adjustment based on each particular situation's ROE.** Understanding, adjusting for, and

properly executing ROE are especially important to success in stability and support operations. The restrictions change whenever the political and military situations change; this means ROE must be explained to friendly soldiers continuously. ROE provide the authority for the soldier's right to self-defense. **Each soldier must understand the ROE and be prepared to execute them properly in every possible confrontation.** In addition, ROE violations can have operational, strategic, and political consequences that may affect national security; the enemy can be expected to exploit such violations.

Rules of interaction

These directives, known as ROI, embody the human dimension of stability and support operations; they lay the foundation for successful relationships with the myriad of factions and individuals that play critical roles in these operations. ROI encompass an array of interpersonal communication skills, such as persuasion and negotiation. These are tools the individual soldier will need to deal with the nontraditional threats that are prevalent in stability and support operations, including political friction, unfamiliar cultures, and conflicting ideologies. In turn, ROI enhance the soldier's survivability in such situations.

ROI are based on the applicable ROE for a particular operation; they must be tailored to the specific regions, cultures, and/or populations affected by the operation. Like ROE, ROI can be effective only if they are thoroughly rehearsed and understood by every soldier in the unit.

Force protection

Because of the influence of local politics and news media in stability and support operations, minimizing casualties and collateral damage become particularly important operational considerations during these operations. At the same time, however, force protection must be a constant priority. In attempting to limit the level and scope of violence used in stability and support operations, leaders must avoid making tactically unsound decisions or exposing the force to unnecessary risks. On the contrary, an overpowering use of force, correctly employed and surgically applied, can reduce subsequent violence or prevent a response from the opposing force. This must be covered in the ROE and the OPORD from the battalion or squadron. Armored forces are commonly deployed in a force protection role.

Task organization

Because of the unique requirements of stability and support operations, the scout platoon may be task organized to operate with a variety of units. This includes some elements with which the platoon does not normally work, such as linguists, counterintelligence teams, and civil affairs teams.

CSS considerations

The operational environment the scout platoon faces during stability and support operations may be very austere, creating special CSS considerations. These factors include, but are not limited to, the following:

- Reliance on local procurement of certain items.
- Shortages of various critical items, including repair parts, Class IV supply materials, and lubricants.
- Special Class V supply requirements, such as pepper spray.
- Reliance on bottled water.

Media considerations

The presence of the media is a reality that confronts every soldier involved in stability operations. All leaders and soldiers must know how to deal effectively with broadcast and print reporters and photographers. This should include an understanding of which subjects they are authorized to discuss and which ones they must refer to the public affairs office (PAO).

Operations with outside agencies

US Army units may conduct certain stability operations in coordination with a variety of outside organizations. These include other US armed services or government agencies as well as international organizations (including private volunteer organizations, nongovernmental organizations, and UN military forces or agencies).

Soldiers' responsibilities

US soldiers may have extensive contact with host-nation civilians during stability and support operations. As a result, their personal conduct has a significant impact on the opinions, and thus the support, of the local population. Soldiers must understand that misconduct by US forces (even those deployed for only a short time) can damage rapport that took years to develop. US soldiers must treat local civilians and military personnel as personal and professional equals, affording them the appropriate customs and courtesies.

To enhance civilian cooperation and support, the platoon leader is responsible for obtaining a key word and phrase card from the S2 to assist in translation of key English phrases into the language of the host nation. These phrases should apply specifically to the area of operations.

Every individual is an intelligence-collecting instrument. The collection of information is a continuous process, and all information must be reported. Intelligence is provided by many sources, including friendly forces, enemy elements, and the local populace. From the friendly standpoint, each soldier must be familiar with the local PIR and other applicable intelligence requirements. At the same time, enemy soldiers will be continuously seeking intelligence on US actions, often blending easily into the civilian population. US soldiers must be aware of this and use OPSEC procedures at all times.

SECTION 2 — STABILITY OPERATIONS

Army elements may be tasked to conduct stability operations to accomplish one or more of the following purposes:

- Deter or thwart aggression.
- Reassure allies and friendly governments, agencies, or groups.
- Provide encouragement and/or support for a weak or faltering government.
- Stabilize an area with a restless or openly hostile population.
- Maintain or restore order.
- Lend force, or the appearance of force, to national or international agreements and policies.

This section provides an introductory discussion of the activities associated with stability operations; for more detailed information, refer to [FM 100-5](#) and [FM 7-98](#).

NONCOMBATANT EVACUATION OPERATIONS

Noncombatant evacuation operations (NEO) are primarily conducted to evacuate US citizens whose lives are in danger, although they may also include natives of the host nation and third-country aliens friendly to the United States. NEOs involve swift insertion and temporary occupation of an objective, followed by a planned withdrawal. Leaders use only the amount of force required for self-defense and protection of evacuees.

SUPPORT TO DOMESTIC AUTHORITY

These operations, covered in [FM 100-19](#), are conducted by military forces in support of federal and state officials under provisions of, and limited by, the Posse Comitatus Act and other laws and regulations. Actions defined by the US Congress as threats to national security warranting military support include drug trafficking, illegal immigration, and customs violations.

PEACE OPERATIONS

Peace operations encompass three general areas: diplomatic activities (peacemaking and peace-building), traditional peacekeeping, and threatened or actual forceful military actions (peace enforcement). The scout platoon may participate in peacekeeping or peace enforcement operations.

Peacekeeping operations

A peacekeeping force facilitates truce negotiations and political settlement of disputes. In doing so, it must assure each side in the dispute that other parties are not taking advantage of settlement terms to their own benefit. Peacekeeping differs from internal security in that the force does not act in support of a government. Rather, the peacekeeping force must remain entirely neutral; if it loses a reputation for impartiality, its usefulness within the peacekeeping mission is destroyed.

Peace enforcement

Several unique characteristics distinguish peace enforcement activities from wartime operations and from other stability operations. The purpose of peace enforcement is to maintain or restore peace under conditions broadly defined at the international level. It may entail combat, armed intervention, or physical threat of armed intervention. Under provisions of an international agreement, the task force or squadron and its subordinate elements, including the scout platoon, may be called upon to use coercive military power to compel compliance with international sanctions or resolutions.

SHOW OF FORCE

Forces deployed abroad lend credibility to a nation's promises and commitments. In support of this principle, show of force operations are meant to reassure a friendly nation or ally through a display of credible military force directed at potential adversaries. These operations may also be conducted to influence foreign governments or political-military organizations to respect US interests.

SUPPORT TO INSURGENCY AND COUNTERINSURGENCY OPERATIONS

This type of support includes assistance provided by US forces to help a friendly nation or group that is attempting to combat insurgent elements or to stage an insurgency itself. This type of stability activity is normally conducted by special forces.

COMBATTING TERRORISM

In all types of stability operations, antiterrorism and counterterrorism activities are a continuous requirement in protecting installations, units, and individuals from the threat of terrorism. Antiterrorism focuses on defensive measures. Counterterrorism encompasses a full range of offensive measures to prevent, deter, and respond to terrorism. For more information on these activities, refer to [JCS Publication 3-07.2](#).

SUPPORT TO COUNTERDRUG OPERATIONS

US military forces may be tasked for a variety of counterdrug activities, which are always conducted in conjunction with another government agency. These activities include destroying illicit drugs and disrupting or interdicting drug manufacturing, cultivation, processing, and smuggling operations. Counterdrug support may take the form of advisory personnel, mobile training teams, offshore training activities, and assistance in logistics, communications, and intelligence.

ARMS CONTROL AND NATION ASSISTANCE

The scout platoon may work with another nation's military to conduct arms control or nation assistance activities. These types of support usually entail short-term, high-impact operations.

SECTION 3 — SUPPORT OPERATIONS

Domestic support operations are always conducted in support of local, state, and federal civil authorities. Overseas support operations are almost always conducted in support of and in concert with other agencies; these may be American or international organizations of either governmental or private affiliation.

Support operations may be independent actions. Conversely, they may complement offensive, defensive, or stability operations. For a more detailed examination of support operations, refer to [FM 100-5](#).

TYPES OF SUPPORT OPERATIONS

Support operations generally cover two broad categories: humanitarian assistance and environmental assistance. Humanitarian assistance operations are people-oriented, focusing on the well-being of supported populations; they provide critical supplies to designated groups at the request of local, state, federal, or international agencies. Environmental assistance focuses on the condition of all types of natural and man-made properties, with the goal of helping to protect and/or restore these properties as

requested. Typically, environmental operations are conducted in response to such events as forest and grassland fires, hazardous material releases, floods, and earthquakes. (**NOTE:** Many support operations combine the actions of both humanitarian and environmental support.)

PHASES OF SUPPORT OPERATIONS

Although each operation is unique, support operations are generally conducted in three broad phases: response, recovery, and restoration. Army elements can expect to be most heavily committed during the response phase. They will be progressively less involved during the recovery phase, with only very limited activity, if any, during the restoration phase.

Response phase

In the response phase, commanders focus on the life-sustaining functions that are required by those in the disaster area. The following functions dominate these response operations:

- Search and rescue.
- Emergency flood control.
- Hazard identification.
- Food distribution.
- Water production, purification, and distribution.
- Temporary shelter construction and administration.
- Transportation support.
- Fire fighting.
- Medical support.
- Power generation.
- Communications support.

Recovery phase

Recovery phase operations begin the process of returning the community infrastructure and related services to a status that meets the immediate needs of the population. Typical recovery operations include the following:

- Continuation of response operations as needed.
- Damage assessment.
- Power distribution.
- Water and sanitation services.
- Debris removal.

Restoration phase

Restoration is a long-term process that returns the community to pre-disaster normality. Restoration activities do not generally involve large numbers of military forces. When they are involved, Army elements generally work with affected communities in the transfer of responsibility to other agencies as military support forces redeploy.

SECTION 4 — ROLE OF THE SCOUT PLATOON IN STABILITY AND SUPPORT OPERATIONS

Because military operations involving the scout platoon occur most often in the state of conflict, the platoon is most likely to operate in support of peacekeeping and peace enforcement. In addition to executing standard platoon missions, scout platoons must be prepared to execute missions or tasks unique to stability and support operations. (**NOTE:** Many of the tasks required during stability and support operations will be performed in a MOUT environment. Refer to [Appendix D](#) for information on MOUT.)

SPECIFIC SCOUT PLATOON TASKS

As part of a force involved in stability and support operations, the scout platoon can expect to perform these tasks:

- Security operations, including the following:
 - Convoy security (refer to [Chapter 4](#) of this manual).
 - Checkpoints.
 - Roadblocks.
 - Searches of personnel and vehicles.
 - Cordon and search operations.
- Reconnaissance operations, including the following:
 - Route reconnaissance (refer to [Chapter 3](#) of this manual).
 - Building searches (refer to [Appendix D](#) of this manual, covering MOUT operations).

Roadblocks, checkpoints, and searches are used to control the movement of vehicles, personnel, or material along a specific route. Roadblocks and checkpoints help to prevent trafficking in contraband and stop the movement of known or suspected belligerents. They are used to control access into restricted or contested areas by individuals or elements that could cause hostilities between warring parties. They also assist friendly forces in detecting and evaluating the behavior patterns of the local populace, a critical part of the intelligence process.

Roadblocks and checkpoints are either deliberate or hasty and can be established on a permanent, temporary, or surprise basis. Individual roadblocks and checkpoints can be established and manned by scout platoons, sections, or squads, depending on the operational environment and the amount of traffic expected to move through the checkpoint.

ROADBLOCKS

A roadblock is used to stop the movement of vehicles along a route or to close access to certain areas or roads. Roadblocks can be established separate from checkpoints or used to channel traffic into a checkpoint. These factors apply in positioning a roadblock:

- It must be covered by observation and direct fire.
- It must be positioned so that it cannot be bypassed.

- If required, positioning must channel traffic into a checkpoint.

A roadblock is considered an obstacle and is set up or constructed like an obstacle. [Figures C-4A and C-4B](#) illustrate types of organization that can be used in establishing a roadblock. Armored vehicles make excellent roadblocks, but local dismounted security must be established to protect vehicles from dismounted attack. Likewise, HMMWVs make excellent hasty roadblocks because of their mobility and austere logistical requirements. Concertina wire should be used to prevent vehicles from running through the roadblock (see [Figure C-4C](#)).

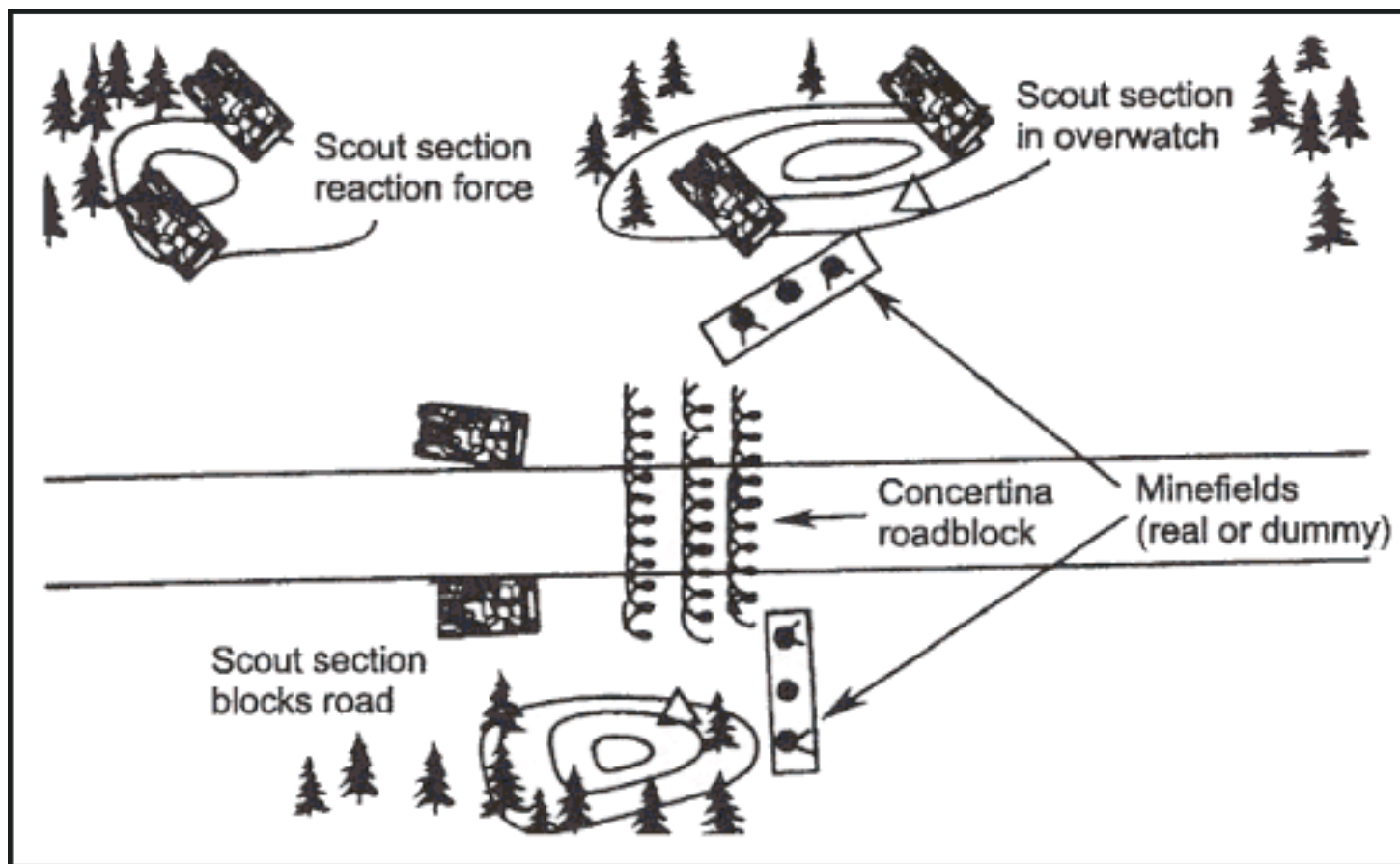

Figure C-4A. Scout platoon roadblock.

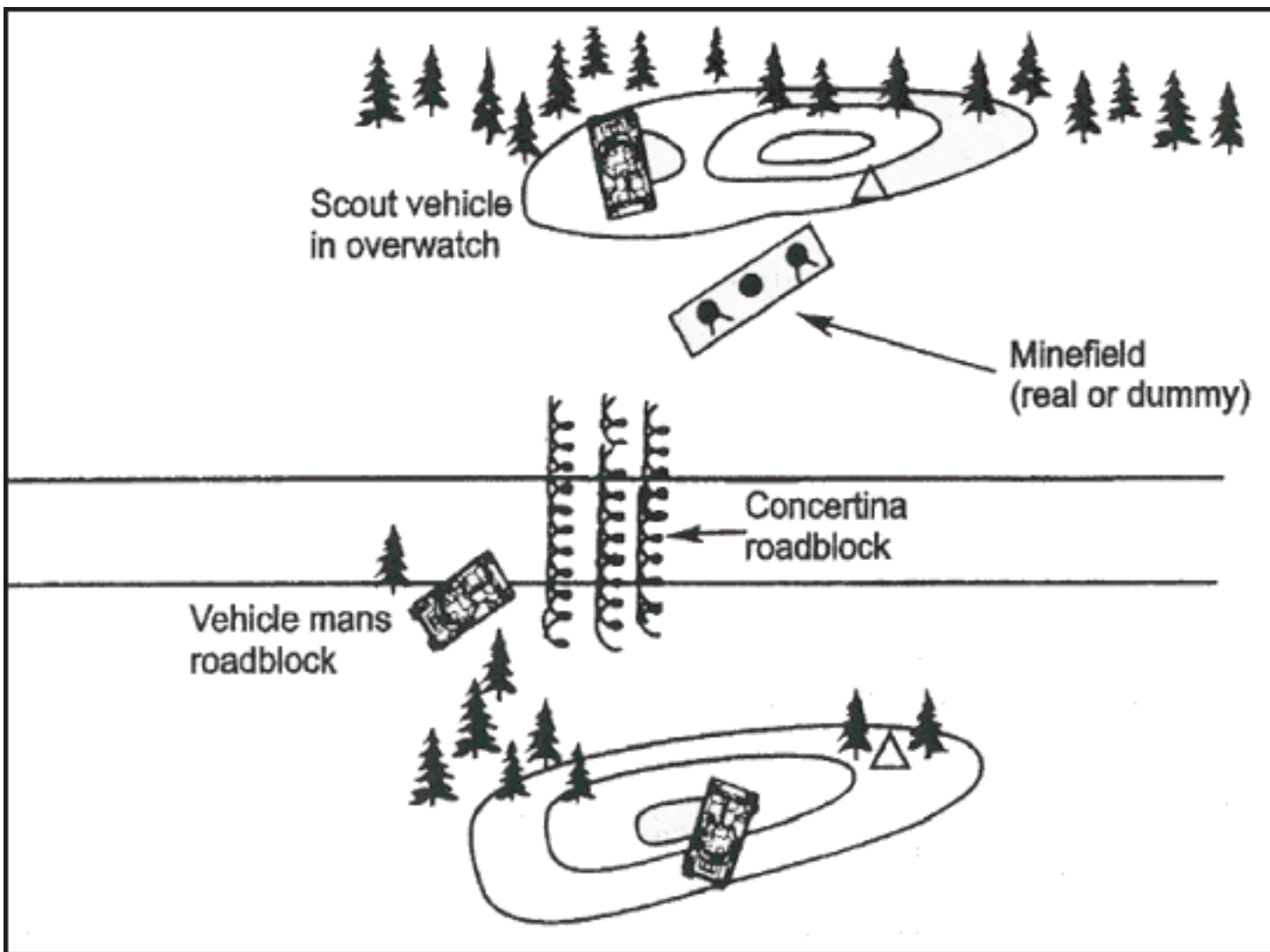

Figure C-4B. Three-vehicle scout section roadblock.

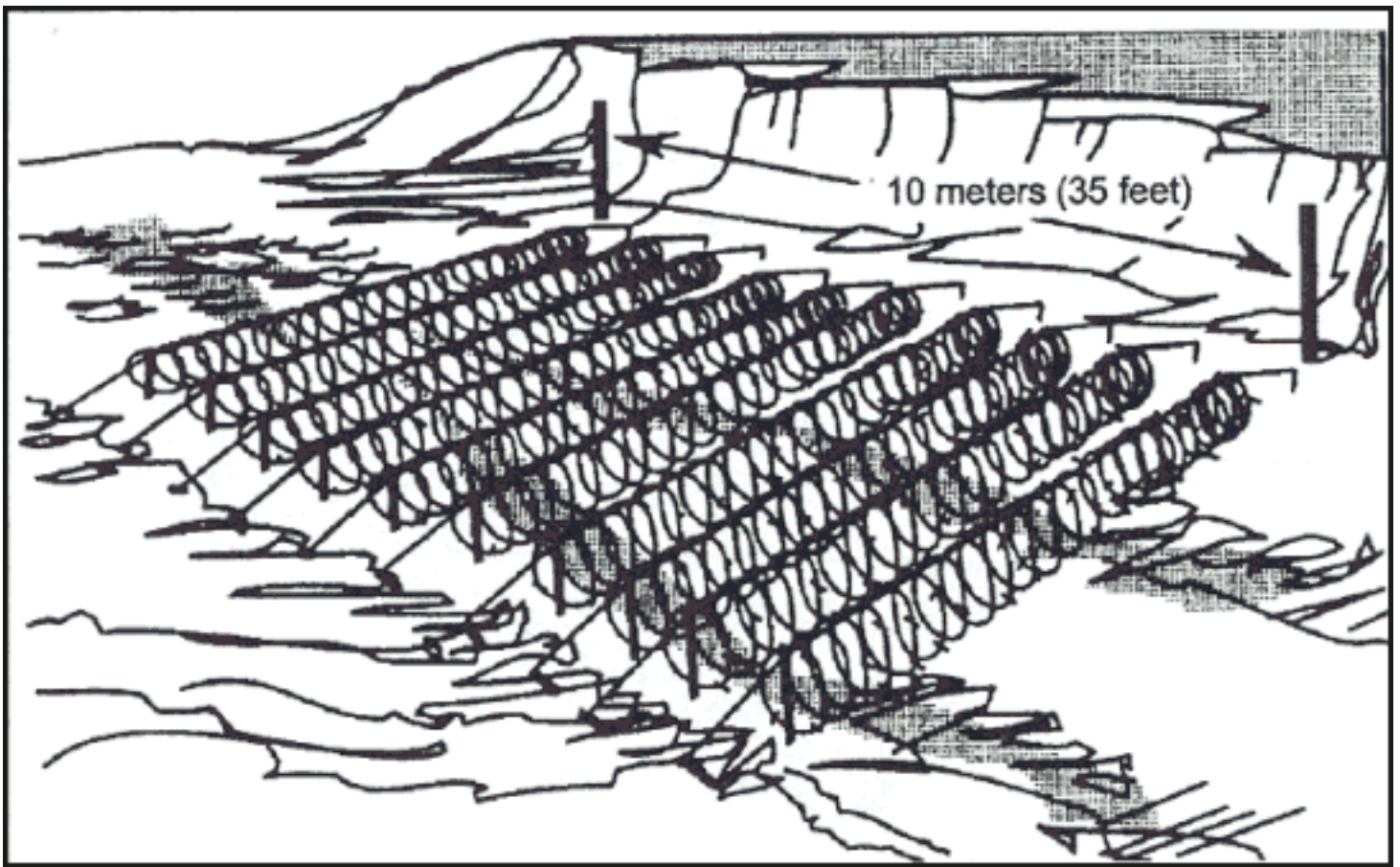

Figure C-4C. Concertina wire roadblock.

CHECKPOINTS

Checkpoints are manned locations used to accomplish the following:

- Control movement along specific routes.
- Maintain continuous monitoring of road movement.
- Apprehend suspects.
- Prevent smuggling of controlled items.
- Prevent infiltration of unauthorized civilians or military forces into or through a controlled area.
- Check vehicles and personnel for weapons, ammunition, and explosives.
- Ensure proper use of routes by civilian and military traffic.

Deliberate checkpoints

The deliberate checkpoint is a relatively fixed position established in a town or in open country, often on a main road (see [Figure C-5](#)). Deliberate checkpoints are classified to handle either heavy traffic or light traffic, based on the amount of traffic expected to pass through them. Scout sections and squads can operate only light traffic checkpoints (see [Figure C-6](#)). The scout platoon can operate both heavy and light traffic checkpoints; [Figure C-7](#) shows a platoon-operated heavy traffic checkpoint.

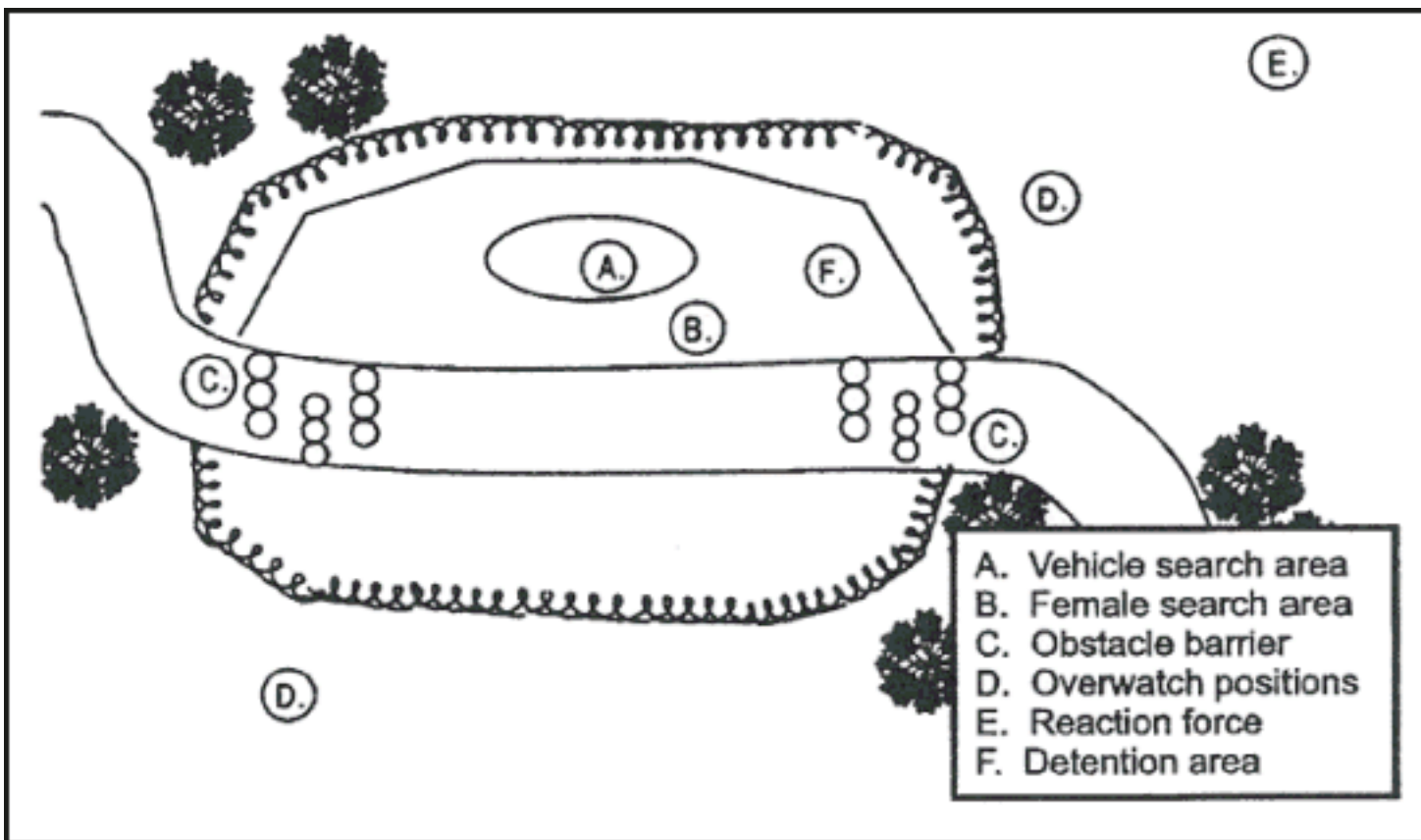

Figure C-5. Deliberate checkpoint organization.

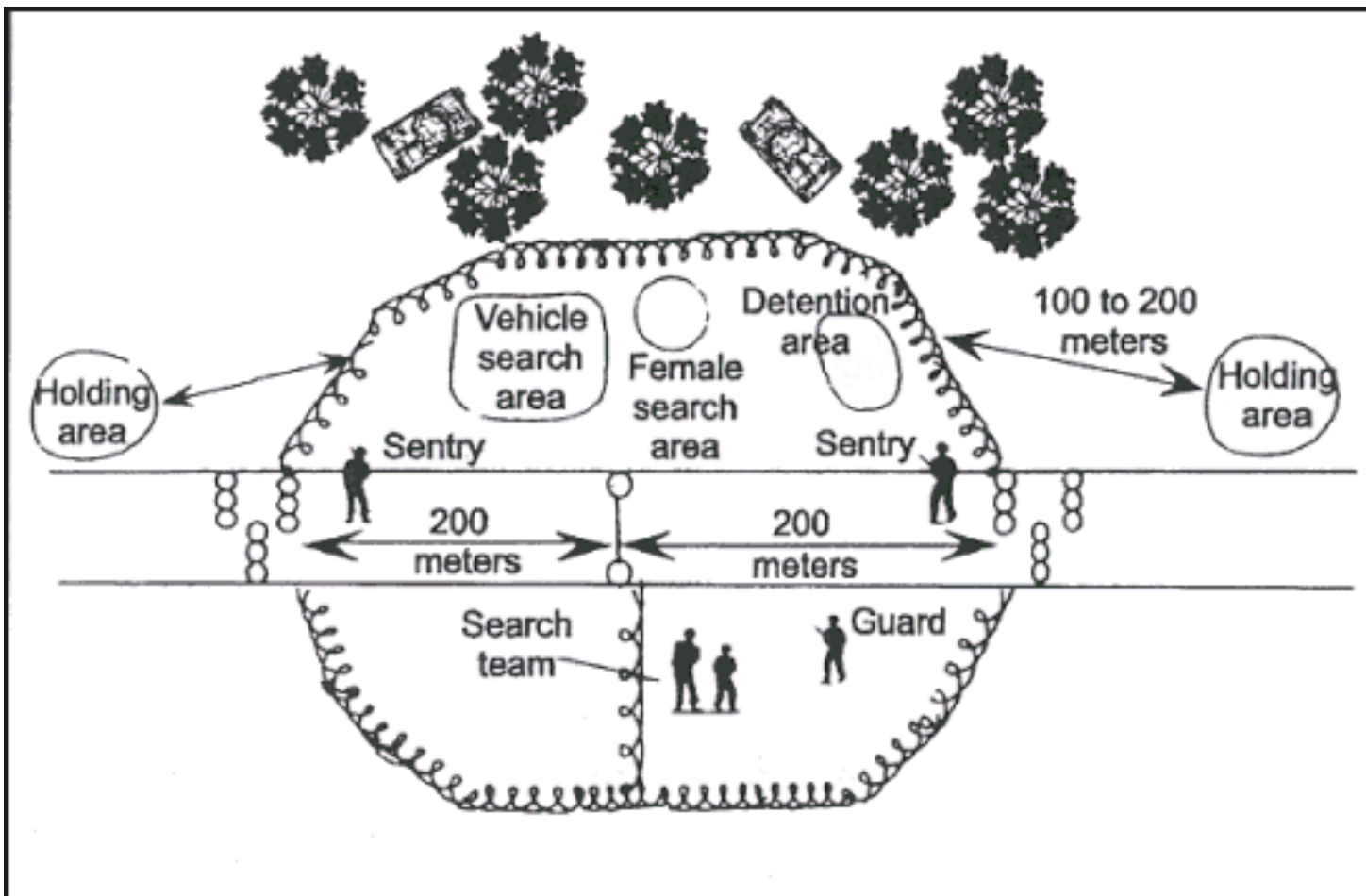
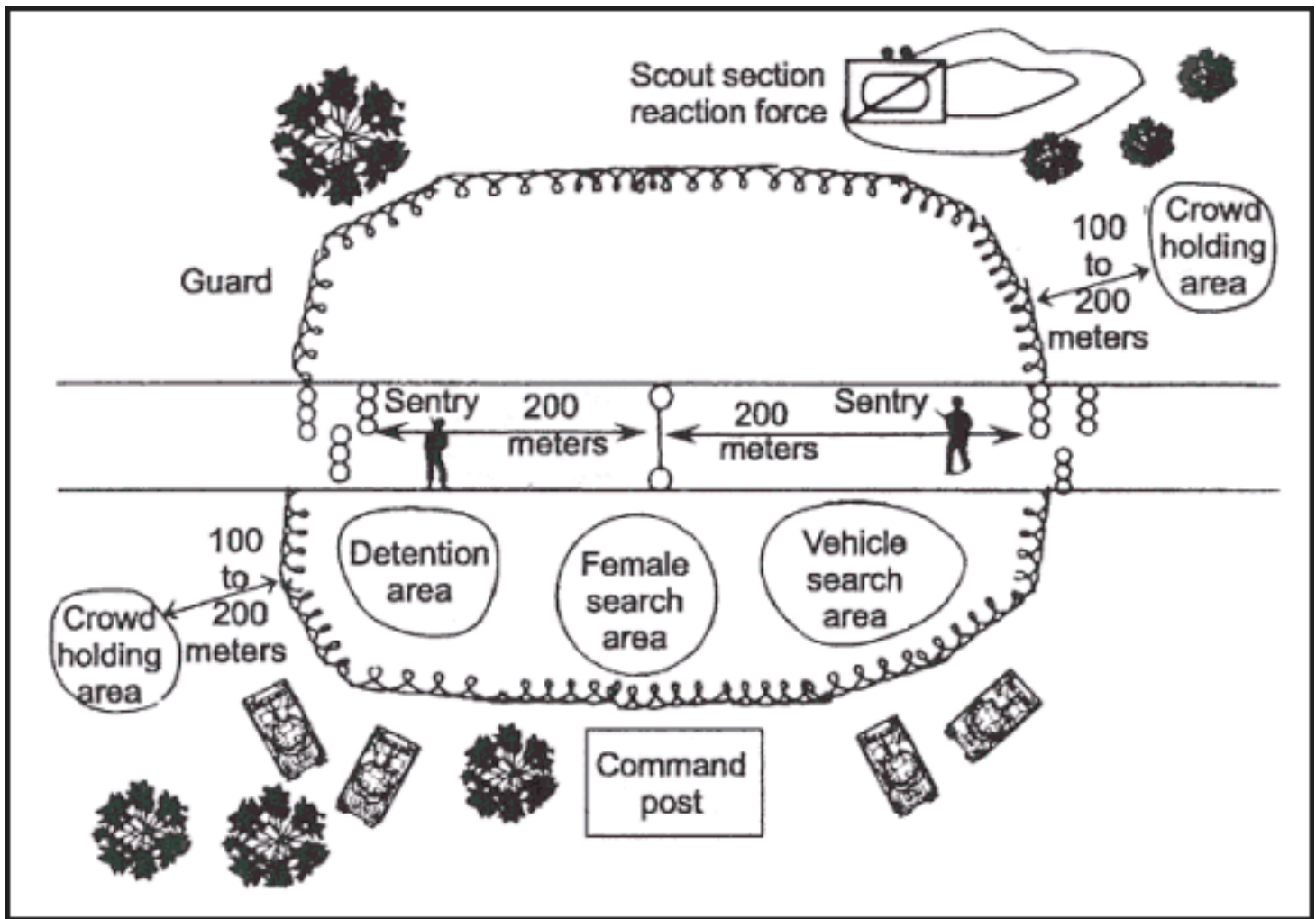

Figure C-6. Scout section manning a light traffic checkpoint.**Figure C-7. Scout platoon manning a heavy traffic checkpoint.**

Establishing a deliberate checkpoint. The physical layout and level of preparation of the checkpoint depend on the amount of traffic expected to pass through it and the duration of its operation. Regardless of the type, all checkpoints have common characteristics and organization. A checkpoint consists of the following parts:

- Obstacles (barriers).
- Search areas.
- Security overwatch and fighting positions.
- Holding area.

Obstacles. A checkpoint is established by placing two parallel obstacles (each with a gap) across the road. These obstacles should be large enough and deep enough to prevent vehicles from running over or through them. The gap must be negotiable by slow-moving vehicles only. The distance between obstacles depends on the amount of traffic that is held in the search area. A barrier pole is placed midway between obstacles to control movement from the search area to the exit obstacle.

Search areas. The amount of traffic held in the search areas is determined by the type of search (see [Figures C-5](#) through [C-7](#), for illustrations of the various checkpoint search areas). Separate search areas

for the following should be set up as needed:

- Vehicles.
- Females.
- Other individuals. These include suspects and other persons detained for further interrogation.

Fighting positions. Fighting positions for vehicles, automatic weapons, and individuals must be emplaced to overwatch, protect, and secure the checkpoint.

Holding area. A holding area is established several hundred meters forward of the checkpoint to control the flow of traffic so that the checkpoint is not overwhelmed.

Task organization. Personnel manning the checkpoint are organized into the following teams or elements to accomplish specific tasks:

- Headquarters element.
- Security force.
- Search teams.
- Sentry teams.

Headquarters element. The headquarters element consists of the platoon leader, PSG, or section leader; an RTO; and medical personnel.

Security force. The security force consists of a security element and a checkpoint reaction force.

The checkpoint security element mans overwatch positions and/or perimeter security positions. Security element personnel maintain overwatch of activities in the search area and provide security for personnel operating the checkpoint. Overwatch positions also provide security for sentry teams and the holding area.

The checkpoint reaction force is a concealed element whose purpose is to prevent traffic from avoiding or bypassing the checkpoint. This force can be part of the perimeter security and can react to surprise attacks against the checkpoint or to other emergency situations. It can be located at a position away from the checkpoint, but it must be able to quickly move to the checkpoint to provide necessary support. The reaction force should be no smaller than a scout section.

Search teams. The search team, comprising two to three soldiers, searches vehicles and personnel. The team is organized into a guard security element and a search element. The guard element provides security during the searches; at least one member of the guard element guards or observes the individuals or vehicles being searched at all times while the searcher conducts the search.

Sentry teams. Sentry teams secure the entrance and exit of the checkpoint and the holding area. They control the flow of traffic through the checkpoint, including movement from the entrance into the search area and from the search area to the exit point.

Other personnel. Whenever possible, the following should be on hand to assist scout platoon personnel with checkpoint activities:

- A civil affairs officer, a liaison officer, or a member of the civilian police or other local authority.
- An interpreter.

- A trained female searcher.

Hasty checkpoints

Hasty checkpoints are set up to achieve surprise. They are established in locations where they cannot be observed by approaching traffic until it is too late to withdraw and escape without being observed.

Possible locations for hasty checkpoints include the following:

- Tunnels and large culverts.
- Bridges.
- Defiles.
- Positions beyond sharp curves.
- Highway intersections.
- Key terrain on highways.
- Reverse slopes of hills.
- Other locations that limit detection from long distances.

The hasty checkpoint has the same basic layout as a deliberate checkpoint; however, because hasty checkpoints are temporary and mobile, the platoon or section establishing the checkpoint must carry the materials necessary to construct it.

The platoon or section uses its vehicles, reinforced with concertina wire, as the obstacle. The vehicles are positioned to partially block the road or route ([Figure C-8](#)). The search area is the space between the vehicles. Sentries are positioned at each end of the checkpoint and are covered by mounted or dismounted automatic weapon positions. A reaction force is designated and concealed nearby.

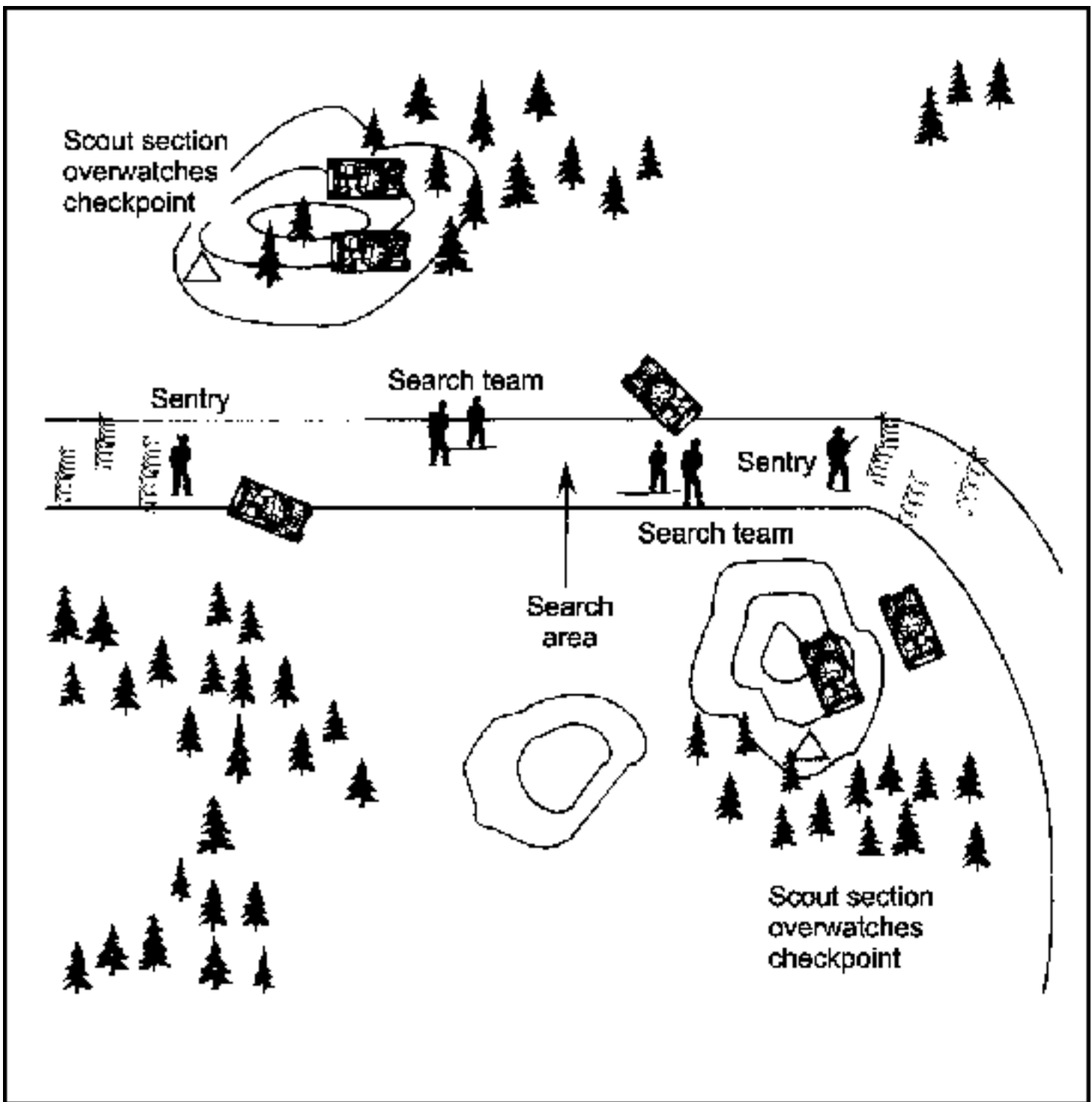

Figure C-8. Scout platoon manning a hasty checkpoint.

Special equipment and personnel requirements

Signs. Portable signs in the local language and in English are required. Signs should denote the speed limit of approach, as well as the vehicle search area, male and female search areas, and dismount point.

Communications. Communications must be established between the checkpoint or roadblock and higher headquarters. FM radios and wire are used within the checkpoint and between the checkpoint and overwatch positions, reaction forces, the checkpoint CP, and sentry posts. Checkpoint personnel also plan for additional means of communications, such as pyrotechnics, flags, hand-and-arm signals, or code words.

Lighting and night observation devices. Adequate lighting for the obstacle, search area, and perimeter area is necessary during night operations. Reaction forces and overwatch elements use NODs to observe outside the perimeter; however, these elements must consider how white light will affect operation of these devices.

Barriers. Obstacles should be positioned across the road and around the search area. These can include barrels filled with concrete or sand, barrier poles, clearly marked barbed wire, buses parked sideways in the road, felled trees, abandoned or disabled vehicles, or other readily available items strong enough and big enough to prevent motorists from driving through or around them. Hasty minefields, both dummy and actual, can be used to reinforce an obstacle.

Weapons. Soldiers must have adequate firepower to withstand an attack or to stop a vehicle that is attempting to flee or crash through the checkpoint. Crew-served weapons must be loaded and manned at all times.

Linguists. Soldiers familiar with the local language are valuable in all roadblock or checkpoint operations. If they are not available, soldiers must be familiar with basic phrases necessary for the operation. They should have a printed reference such as a key word and phrase card; this should be obtained from the civil affairs section, translation detachment, local authorities, or liaison officers as soon as the mission is received.

Other equipment. Other specialized equipment may be required to support the checkpoint mission. [Figure C-9](#) provides a list of equipment that may be helpful.

Other planning considerations

The scout platoon leader must take the following requirements into account when planning the checkpoint mission:

- Obtaining indirect fire support on key terrain around the checkpoint.
- Ensuring that checkpoints are designed so that the minimum number of soldiers are exposed at any given time.
- Positioning automatic weapons to provide protection when soldiers are exposed.
- Ensuring that reinforcement and counterattack plans are developed and rehearsed.
- Ensuring that ROE are clear and understood by all soldiers manning the checkpoint.
- Planning for 24-hour operation of the checkpoint.
- Obtaining logistical support.
- Coordinating for medical assistance and MEDEVAC assets.

GENERAL

**ROADBLOCKS/
CHECKPOINTS**

SEARCHES

Pyrotechnic pistols Riot guns Tear gas launchers Hand-held flashlights Antiriot helmets Shields, 3-ft 6-in Police batons Handcuffs Body armor Marshaling wands Telescopes and tripods Binoculars Infared devices Loudspeakers Fire extinguisher Cameras with flash attachments and tripods Telescopic sights Photographic filter Instant cameras Whistles Hand-held radios (for use in urban areas)	Portable lamp/lights Marker lights Traffic cones Traffic signs Visor sleeves Tire puncture chains Directional arrows Lightweight barriers Mirrors	Ladders Flashlights Picks/shovels Wrecking bars Hand tools, fluorescent hammers, pliers screwdrivers Rope Magnets Telescopic mirror Axe Mine markers Helmets White tape Mine detectors Eye shields Measuring tape Metal-cutting tools Chisels Knives Saws Mine probes Safety harness
--	---	--

Figure C-9. Equipment list for roadblocks and checkpoints.

Preparing for contingencies at checkpoints

Scout platoon leaders must develop tactics and procedures to respond to various situations that can develop at a checkpoint. For example, a high volume of pedestrian and vehicle traffic can be expected to pass through a checkpoint; this congestion can be compounded by undisciplined driving habits of the local population and by the shortage of soldiers able to speak the local language. Belligerents can use the resulting confusion to smuggle weapons and explosives through the checkpoints. In addition, checkpoints face the constant threat of violence.

Leaders must plan for these contingencies when preparing personnel to man checkpoints. The ROE must be clear and flexible enough to accommodate rapid changes in any situation that may develop. [Figure C-10](#) lists some examples of situations encountered at checkpoints, along with possible responses.

SITUATION**POSSIBLE RESPONSES**

- | SITUATION | POSSIBLE RESPONSES |
|--|---|
| <ul style="list-style-type: none"> ● Diversions covering the efforts to sneak or rush through the checkpoint, such as: <ul style="list-style-type: none"> -- Sniper attack. -- Ambulance arriving at checkpoint, with sirens blaring. -- Staged fights or riots near the checkpoints. | <ul style="list-style-type: none"> ● Close the checkpoint; rapidly emplace barricades to stop and contain both vehicular and pedestrian traffic in and around the checkpoint. ● Use reaction force to handle situations outside checkpoint so that checkpoint personnel do not have to leave it. ● Remain calm; report to higher headquarters. |
| <ul style="list-style-type: none"> ● Sniper fire. | <ul style="list-style-type: none"> ● Take cover. ● Employ smoke. ● Protect wounded. ● Identify location of sniper. ● Report. ● Respond in accordance with ROE. |
| <ul style="list-style-type: none"> ● Thrown projectiles. | <ul style="list-style-type: none"> ● Maintain standoff. ● Protect self and others. ● Do not throw objects back. ● Report. ● Respond with force in accordance with ROE. |
| <ul style="list-style-type: none"> ● Imminent harm. | <ul style="list-style-type: none"> ● Protect self and others. ● Use force in accordance with ROE. ● Report. |
| <ul style="list-style-type: none"> ● Civilian casualty. | <ul style="list-style-type: none"> ● Provide first aid. ● Report; request MEDEVAC |
| <ul style="list-style-type: none"> ● Drive-by shooting. | <ul style="list-style-type: none"> ● Take cover. ● Report. ● Respond with force in accordance with ROE. |

Figure C-10. Responses to situations at a checkpoint.

SEARCHES OF PERSONNEL AND VEHICLES

Searches of people, material, and vehicles are commonly used at roadblocks and checkpoints to control unauthorized movement of individuals and prohibited items (contraband).

Planning guidelines for search operations

Planning for a search operation should cover these points:

- Search authority.
- Conduct of the search.
- Search rates.
- Use of force.
- Courtesy.

Search authority. Checkpoint personnel perform searches to apprehend suspects or confiscate contraband only in areas within their military jurisdiction (or where otherwise lawful). Proper use of search procedures gains the respect and support of the local population, enhances credibility, and demonstrates impartiality. Conversely, misuse of search authority can undermine the credibility of forces conducting operations in the area; it can also affect future operations. Checkpoint personnel must ensure that search procedures are conducted in accordance with established guidelines and the applicable ROE.

Conduct of the search. All checkpoint personnel must thoroughly understand the instructions issued for the conduct of searches. Instructions may cover, but are not limited to, the following points:

- Personnel, vehicles, and/or items allowed to pass through the checkpoint.
- Personnel and/or vehicles not allowed to pass through the checkpoint.
- Procedures for detaining vehicles or personnel.
- Items to be confiscated.
- Procedures for handling confiscated items.

Search rates. Search operations are conducted slowly enough to allow for a thorough search but rapidly enough to prevent the enemy from reacting to the threat of the search.

Use of force. In accordance with established ROE, minimum essential force is used to eliminate any active resistance encountered during the search.

Courtesy. Search personnel should remain polite and considerate at all times. [Figure C-11](#) lists guidelines for personal conduct during search operations.

DO take these actions during a search operation:

- Maintain professional, courteous demeanor when approaching the vehicle and talking to the vehicle and talking to the driver.
- Speak only to the driver; let him speak to the passengers.
- Ask the driver politely to do what you want him to do.
- Speak naturally and no louder than needed.
- When searching an individual, be courteous. Use scanners whenever possible.
- Whatever happens at the checkpoint, stay calm and make a special effort to be polite, regardless of your feelings.
- Always maintain a high standard of dress and military bearing. If you look smart and professional, people are more likely to accept your authority and be willing to cooperate.
- Contact your checkpoint commander whenever necessary.
- Maintain situational awareness at all times.
- Maintain strict security at all times

DO NOT take these actions during a search operation:

- Show disrespect or give any hint of dislike.
- Speak to woman regardless of their age.
- Put your head or arm in through the side window or open the door without permission.
- Shout or show impatience.
- Frisk women or tell them to put their hands up.
- Point your weapon directly at people unless essential for security reasons.
- Become involved in a heated argument.
- Use force unless force is used against you. Use the minimum force necessary.
- Become careless or sloppy in appearance.
- Establish a routine pattern of operations. This will allow the enemy to take advantage of the checkpoint operations.

Figure C-11. "Dos" and "don'ts" of search operations.**Search procedures**

Search of individuals. To avoid making an enemy of a person passing through a checkpoint, searchers must be polite, considerate, patient, and tactful. Since the very presence of checkpoints can cause uneasiness or fear, it is during the initial handling of a person about to be searched that the greatest caution is required. At least one member of the search team must provide security at all times while others conduct the search. The following methods can be used to search an individual:

- Frisk search.
- Wall search.
- Strip search.

- Female search.

Frisk search. This is a quick search of an individual for weapons, evidence, or contraband. It should be conducted in the presence of an assistant (guard) and a witness, when available. In conducting the frisk search, the searcher positions himself to prevent possible endangerment (see [Figure C-12](#)). The searcher's guard takes a position from which he can cover the individual with his weapon. The searcher must avoid moving between the guard and the individual being searched. The searched individual is required to raise his arms above his head. The searcher slides his hands over the individual's entire body, crushing the clothing to locate concealed objects. If the individual being searched is carrying a bag or wearing a coat or hat, these are also searched, with special attention given to the linings.



Figure C-12. Frisk search.

Wall search. The wall search affords the searcher some safety by placing the individual being searched in a strained, awkward position (see [Figure C-13](#)). This search method is useful when two searchers must search several individuals. The individuals to be searched can be positioned against any upright surface, such as a wall, vehicle, tree, or telephone pole. The following discussion covers factors that must be considered during the wall search.

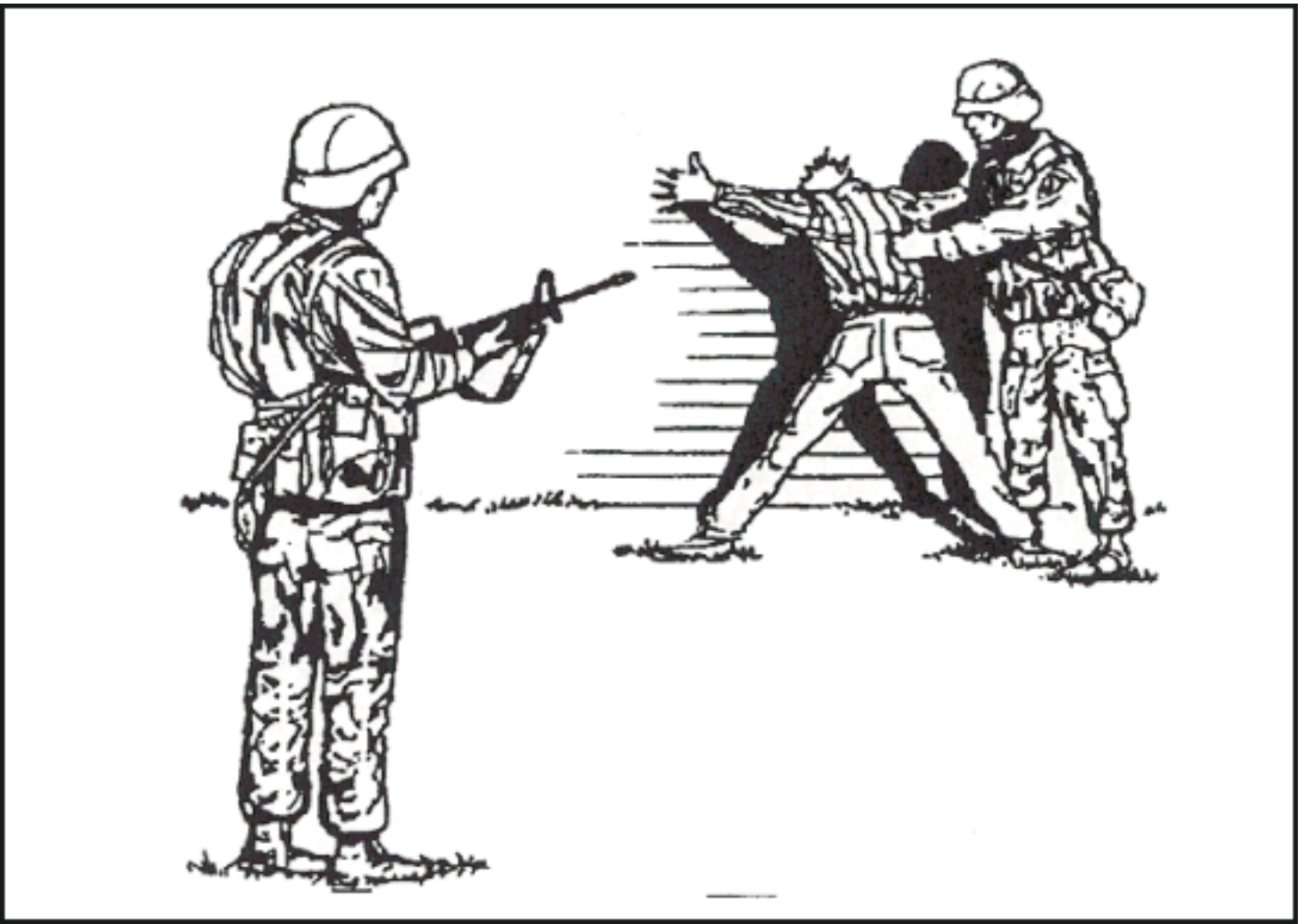

Figure C-13. Wall search.

Position of individual being searched. The individual must face the wall (or other object) and lean against it, supporting himself with his hands over his head, placed far apart with fingers spread. His feet are placed well apart as far from the wall as possible; they are turned outward so they are parallel to the wall. The individual must keep his head down as illustrated in [Figure C-13](#).

Position of the searcher's guard. The searcher's guard stands to the rear of the individual being searched on the opposite side from the searcher (see [Figure C-13](#)). The guard uses his weapon to cover the individual being searched. When the searcher moves from his original position to the opposite side of the individual being searched, the guard also changes position. The searcher walks around the guard to avoid coming between the guard's weapon and the individual being searched.

Position of the searcher. The searcher approaches the individual being searched from the right side. The searcher must secure his weapon so that the individual being searched cannot grab it.

When searching from the right side, the searcher places his right foot in front of the individual's right foot, making and maintaining ankle-to-ankle contact. If the individual offers resistance, this position allows the searcher to push the individual's right foot back and out from under him, causing him to fall to the ground. When searching from the left side, the searcher places his left foot in front of the individual's left foot and makes and maintains ankle-to-ankle contact. [Figure C-14](#) illustrates the ankle-to-ankle position.



Figure C-14. Ankle-to-ankle position for a wall search.

Wall search procedures. In taking his initial position, the searcher must remain alert to prevent the individual being searched from making a sudden move to disarm or injure him. The searcher first searches the individual's headgear. Then he checks, in sequence, the individual's hands and arms, the right side of his body, and his right leg. The searcher repeats the procedure on the left side of the individual. He crushes the person's clothing between his fingers rather than merely patting the surface of the clothing. The searcher pays close attention to the armpits, back, waist, legs, groin area, and tops of boots or shoes. Any item that is not considered a weapon or evidence is replaced in the individual's pocket. If the individual resists, attempts to escape, or must be thrown down before the search is completed, the search is restarted from the beginning.

Search of multiple individuals. When two or more individuals are to be searched, they must all assume a position against the same wall or object but far enough apart that they cannot reach each other. The guard takes a position a few paces to the rear of the line with his weapon ready. The search starts with the person on the right end of the line. Upon completing the search of the first individual, the searcher moves that individual to the left end of the line; the individual assumes the proper position against the wall. The searcher resumes with the individual now on the right end of the line. The searcher must be careful to approach and search the remaining individuals without coming between them and the guard (see [Figure C-15](#)).

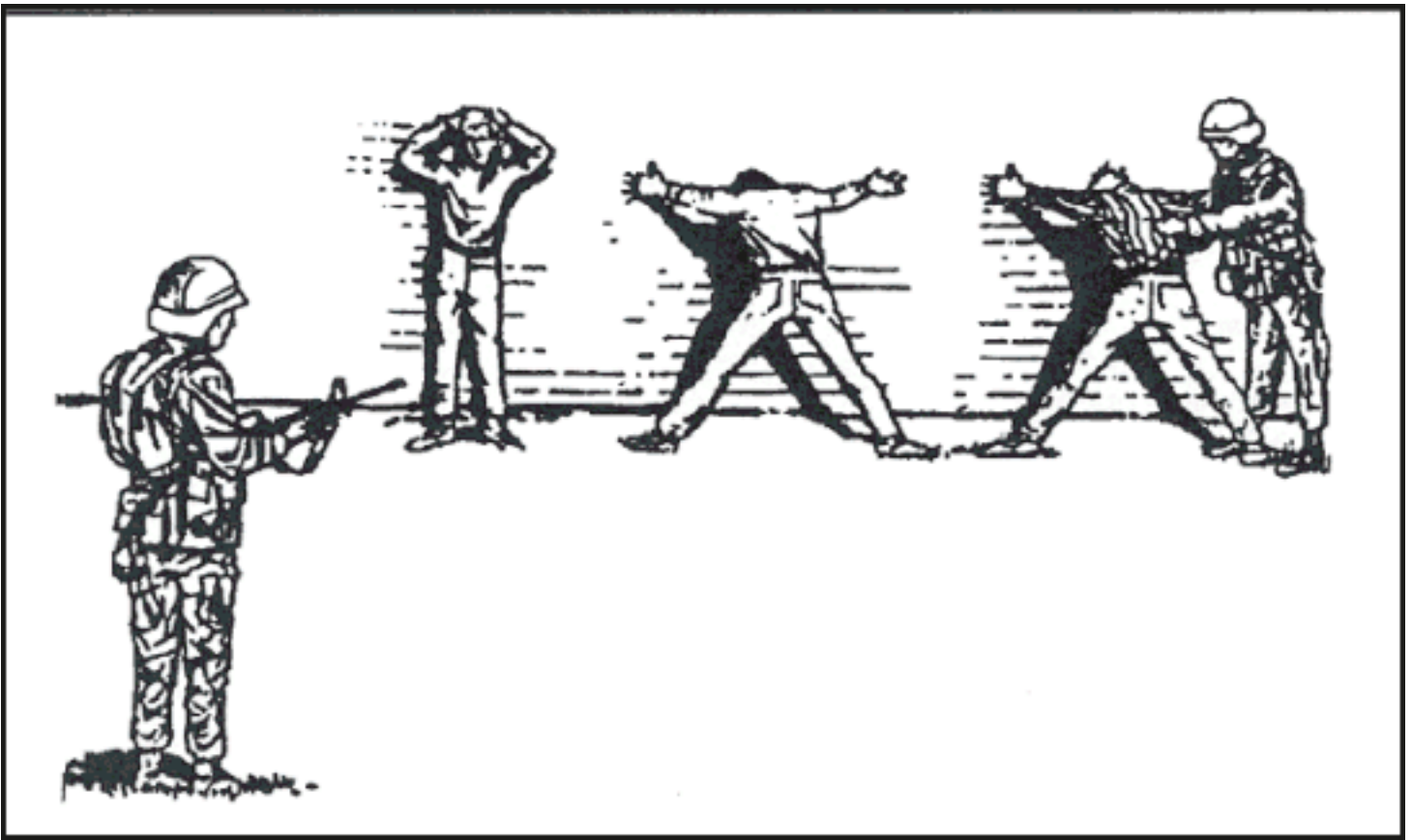

Figure C-15. Wall search of multiple subjects.

Strip search. This extreme search is used only when the individual is suspected of carrying documents or other contraband on his person. The search is conducted in an enclosed area such as a room or tent. Several search techniques are available. One method is to use two unarmed searchers while an armed guard provides security. The individual's clothing is removed and searched carefully. A search is then made of all possible concealment areas, including the mouth, nose, ears, hair, armpits, and groin area. A medic is a good choice to conduct this search. Care must be taken not to subject the individual to unnecessary embarrassment. Searchers must ensure that the person's privacy and dignity are maintained as much as possible.

Search of females. Women should be used to search other females whenever possible. If female searchers are not available, consider using doctors, medics, or designated males from the local population. If male soldiers must search females, all possible measures must be taken to prevent any action that could be interpreted as sexual molestation or assault.

Search of vehicles. Vehicles searches may require special equipment such as metal detection devices and mirrors. Because a thorough vehicle search is a time-consuming process, a separate search area should be established to prevent unnecessary delays. [Figure C-16](#) shows an example of a search rate planning guide.

SEARCH PATTERN	RATE (veh/hr/lane)	TIME (per vehicle)
None	600-800	-
Vehicle Decal ID Check	400-600	10 sec
Driver ID Check	200-400	20 sec
Visual Observation of Passengers and Cargo Area	150-300	25 Sec
Basic Physical and Visual Search of Passengers and Cargo Area	50-150	1.2 min
Comprehensive Vehicle Search	12-24	5 min

Figure C-16. Example rate planning guide for vehicle searches.

Searchers instruct all occupants to get out and stand clear of the vehicle. The driver should be made to watch the search of the vehicle. A guard watches the passengers and provides additional security at all times. If sufficient searchers are available, the passengers should be searched at the same time. [Figure C-17](#) lists some examples of vehicle search procedures.

SITUATION	RESPONSE
Weapons or explosives may be hidden in vehicle fuel tanks or inside components of vehicles.	Look for newly replaced vehicle components, scratches on vehicle components, new nuts and bolts, or other signs of recent work.
Weapons, explosives, and combatants may be sealed in hearses and ambulances with bodies or wounded civilians.	Treat these vehicles with respect, but search them and their contents thoroughly, including caskets. Do not disturb bodies. Have medics verify wounds.
Females may be used to smuggle weapons and explosives.	Male soldiers should not touch females; use female searchers or metal or mine detectors whenever possible. Use medical personnel if no female searches are available.

Figure C-17. Example vehicle search procedures.

CORDON AND SEARCH OPERATIONS

When intelligence identifies and locates members of an insurgent infrastructure, cordon and search operations are mounted to neutralize them. This discussion covers procedures for the scout platoon in support of the light infantry company or battalion conducting these operations.

Task organization

Task organization for cordon and search operations includes a security force (cordon force), a search force, and a reserve force. The scout platoon will normally operate as part of the security force or the reserve force; if required, however, it can operate either by itself as the search force or as part of a larger search force.

Conduct of the operation

Search zones are designated; a search party is assigned to each zone. Each search party has its own search force, security force, and reserve force.

Procedures. An effective cordon is critical to the success of the search effort. Cordons isolate the search area, prevent the escape of individuals, and protect the forces conducting the operation. Deployment to the search area is rapid and is synchronized so it does not provide early warning to the local population; the security force surrounds the area while the search force moves in (see [Figure C-18](#)).

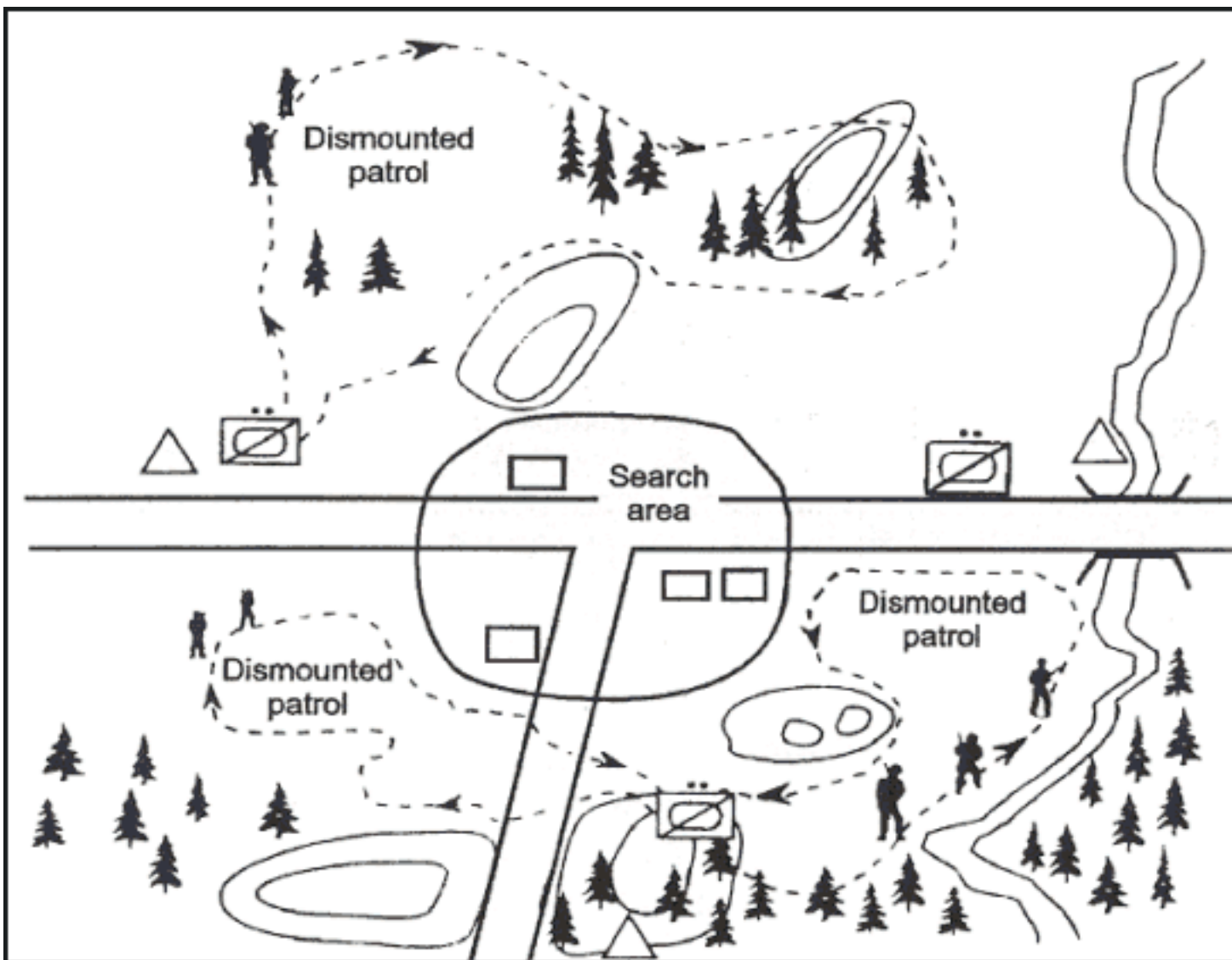

Figure C-18. Scout platoon establishes 360-degree security.

Checkpoints and roadblocks are established along roads entering and exiting the area (see [Figure C-19](#)). OPs are established, and security patrols are executed in the surrounding area. Members of the security force orient mainly on people or vehicles attempting to escape or evade the search in the populated area; however, the security force can also cut off elements or individuals trying to reinforce enemy forces in the search area.

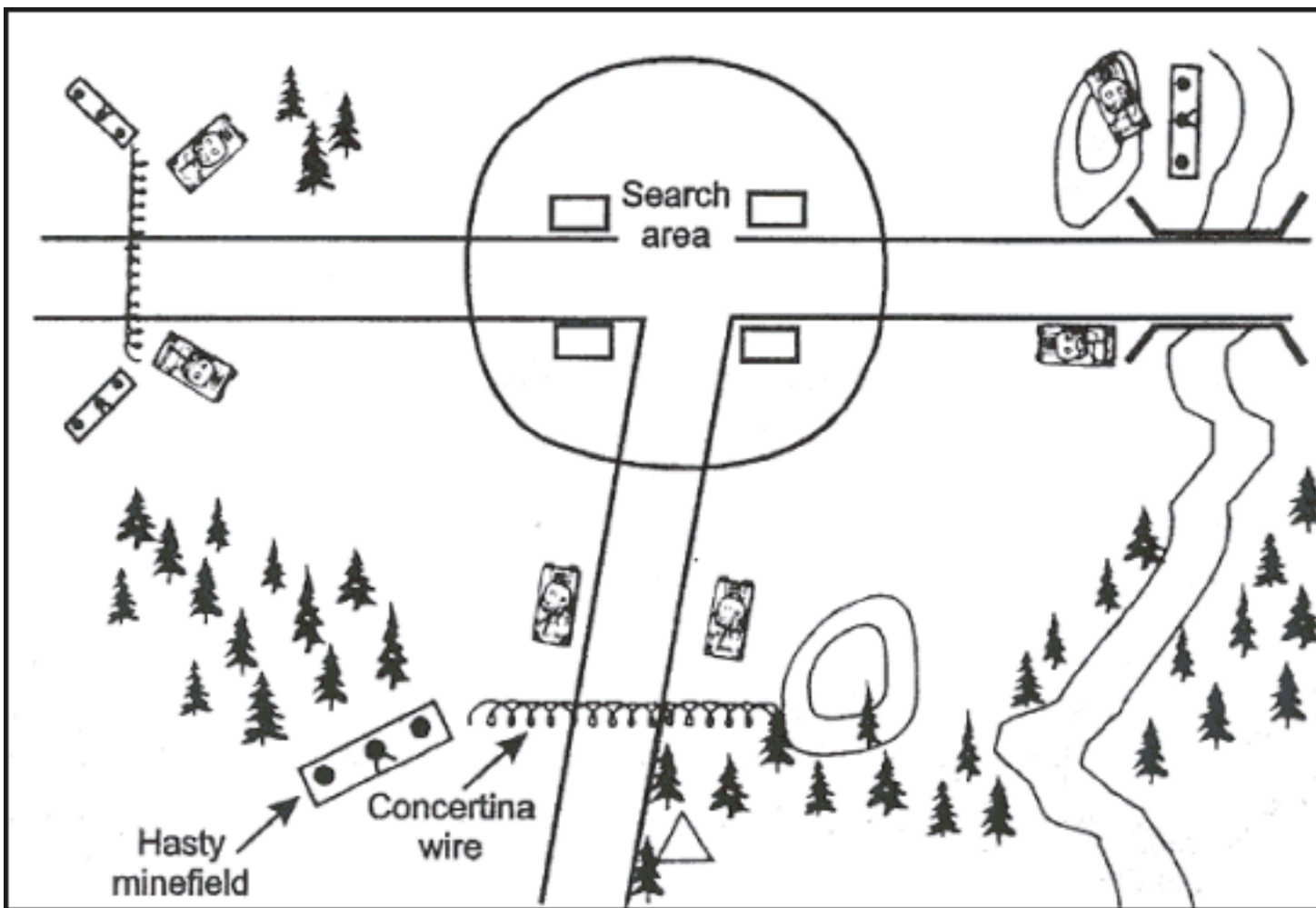

Figure C-19. Scout sections establish hasty roadblocks.

Reserve force. A mobile reserve force is located near the search zone. Its specific mission is to reinforce OPs, patrols, or the search force and to assist the other elements as required by the mission (see [Figure C-20](#)).

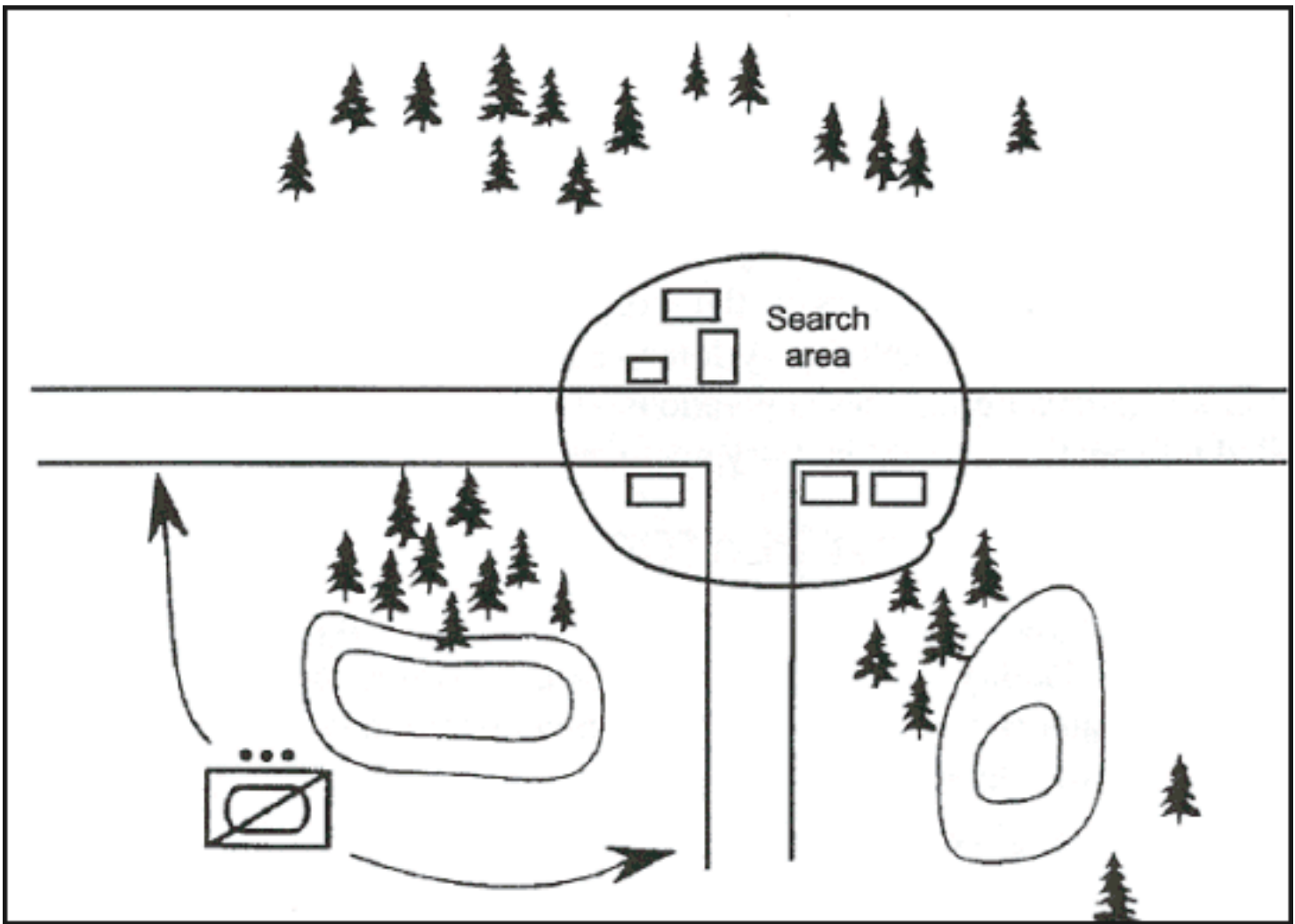

Figure C-20. Scout platoon operates as the reserve force.

SECTION 5 — LIGHT/HEAVY OPERATIONS IN STABILITY/SUPPORT ENVIRONMENTS

During stability and support operations, numerous situations may arise requiring armored and light forces to operate together. The use of a mixed force capitalizes on the strengths of both forces while offsetting their respective weaknesses. Light/heavy operations take advantage of the light unit's ability to operate in restricted terrain (such as urban areas, forests, and mountains), while increasing the light unit's survivability. Conversely, the armored unit's mobility, protection, and firepower complement the light infantry unit's capabilities.

The scout platoon will operate with light infantry forces in various task organizations. Examples of these organizations include the following:

- The cavalry squadron or troop is attached or OPCON to a light infantry brigade.
- A light infantry company is attached to an armor or mechanized battalion or cavalry squadron.
- The scout platoon is attached to a light infantry brigade as part of an armor company team.

Regardless of the task organization, the key challenge in light/heavy operations is to understand the capabilities and limitations of light and armored forces, to develop plans that take full advantage of their

capabilities, and to correctly employ the two types of forces for maximum effectiveness. The goal of this section is to assist the scout platoon leader in understanding the platoon's role in the light/heavy force and in planning and executing the platoon's missions during these operations. (**NOTE:** Refer to [FM 7-10](#) for detailed information on light infantry organizations.)

ROLE OF THE SCOUT PLATOON

The scout platoon normally does not conduct close support of infantry operations. In stability and support operations, however, the scout platoon can use its unique capabilities to conduct combat operations in support of or in conjunction with light infantry.

Along with conventional reconnaissance and security missions, the platoon can support infantry in MOUT and in cordon and search operations. It can also provide protection against enemy armored forces.

THE THREAT

Light infantry fights a variety of enemy forces. These may range from crudely equipped insurgents to technologically advanced conventional forces. Potential threat targets include the following:

- Nonarmored targets, including the following:
 - Bunkers.
 - Automatic weapon positions.
 - Buildings and walls.
 - Roadblocks and obstacles.
- CPs.
- Logistical positions.
- Light-skinned vehicles.
- Armored vehicles.

CAPABILITIES AND LIMITATIONS OF THE SCOUT PLATOON

Capabilities

Capabilities of the scout platoon in support of light/heavy operations include the following:

- Ability to suppress or destroy enemy positions with direct fires from the caliber .50 heavy machine gun, 40-mm grenade launcher, or 25-mm chain gun.
- Ability to breach walls and reduce obstacles with direct fire.
- Enhanced communications assets.
- Thermal sights and NODs.
- Capability for rapid movement and limited penetrations.
- Use of CFVs to provide protection against light AT fires, small arms, and fragments.

Limitations

The scout platoon's limitations in light/heavy operations include these:

- Restricted mobility and fields of fire in close or urban terrain.
- Vulnerability to antiarmor weapons in built-up areas.
- The CFV's consumption of large quantities of Classes III, V, and IX, requiring daily resupply.
- Need for augmentation of transportation assets to support CSS requirements.
- Possibility that bridges and roads may not support CFVs.
- Inability to move over soft or heavily wooded terrain traversable by light infantry.

LIGHT/HEAVY MOUT OPERATIONS

MOUT battlefields are complex and three-dimensional; they are characterized by the close, restricted terrain typical of built-up areas, resulting in severely limited fields of fire and maneuver space. Mounted avenues of approach, restricted mostly to streets and alleys, are narrow, canalized, and easily obstructed. On the other hand, cover and concealment are plentiful for dismounted forces. Dismounted avenues of approach are literally everywhere; they can be underground, through buildings, along edges of streets, and over rooftops.

While MOUT are predominantly an infantry fight, the scout platoon can support light infantry units by providing security, protection, mobility, and firepower. The scout platoon can perform the following tasks to increase the combat power of the light infantry force:

- Isolate objectives with direct fires to prevent enemy withdrawal, reinforcement, or counterattack.
- Suppress or destroy enemy positions.
- Breach walls and blocked doorways.
- Reduce barricades and obstacles with direct fires.
- Reduce enemy strongpoints.
- Establish roadblocks.
- Protect against enemy armored attacks or counterattacks.
- Suppress sniper fires.
- Use CFVs to provide protection from small arms and fragmentation rounds.
- Overwatch likely armor avenues of approach.

For a more detailed discussion of the scout platoon's role in MOUT, refer to [Appendix D](#) of this manual.

APPENDIX D

Military Operations on Urbanized Terrain

Because of the trend of increasing urbanization in every region of the globe, the potential is growing for US forces to become embroiled in combat operations in urban settings. Known as MOUT, these operations are conducted on a complex, three-dimensional battlefield. Characteristics of this area of operations include close, restricted terrain; severely limited fields of fire and maneuver space for mounted elements; and virtually unlimited cover and concealment for dismounted forces.

The urban battlefield presents commanders and leaders, including the scout platoon leaders and his subordinates, with many challenges. At the tactical level, the platoon leader must decide how he will deal with the civilian population, what tactics and weapons systems he can employ, and which key terrain within the city his unit must seize to achieve designated objectives. The enemy may deliberately try to avoid engagement by entering and hiding within the cluttered urban environment. On the other hand, he may have been forced to operate in and around an urban area simply because much of his logistics support is located there.

In some instances, both combatants may simultaneously recognize that an urban area constitutes a decisive point on the battlefield. Combat becomes unavoidable. In this uncertain environment, the scout platoon, whether it is charged with gathering reconnaissance information or providing security to the friendly main body, can find itself conducting MOUT.

NOTE: Refer to [Appendix C](#) of this manual for a discussion of stability and support operations, some of which are conducted in the MOUT environment.

CONTENTS

[Section 1](#) [General Considerations](#)

[Section 2](#) [Role of the Scout Platoon in MOUT](#)

[Section 3](#) [Conduct of MOUT](#)

SECTION 1 — GENERAL CONSIDERATIONS

The worldwide trend toward urbanization is making it increasingly difficult for military forces to avoid or to physically bypass built-up areas. Many cities have grown explosively, their halted only by terrain

that is unfavorable to urban life and military operations alike. As a result, the only maneuver options available to commanders may include attacking through urban areas.

Given the highly variable factors that must be taken into account, the friendly commander can be faced with the choice of entering this environment to destroy the enemy, isolating the enemy within the urban area, or engaging the enemy only if he emerges into more open terrain. In each instance, the commander's reconnaissance effort is initially focused on gathering information that will enable him to determine the best choice given the specific parameters of his mission. After this choice has been made, reconnaissance focuses on obtaining information to support the desired COA.

As the Army makes the transition from a forward-deployed force to one that relies on force projection, the capture of ports and airfields will become increasingly significant during forced-entry operations. Such operations will invariably occur in urban terrain, with the attacking force attempting to secure or adjacent urban areas that will permit it to establish (and subsequently expand) its initial lodgment.

In addition, the capture of cities can provide significant resources that the attacker who then use to his advantage. For example, cities lie along key lines of communications and provide a tactical advantage to the commander who controls them. Control of key infrastructure such as bridges, telephone exchanges, and water and electrical generating/distribution stations can significantly influence both the actions of both the local population and the enemy. Battalion scouts can expect to receive missions to locate critical structures and facilities, as well as to identify enemy forces tasked with defending or securing these key points.

The decision to commit forces into urban areas may also be based on the potential threat these areas, and the human elements in them, pose to other operations. As an example, the terrain around a built-up area may facilitate a bypass, but the enemy force within the urban area may be able to interdict lines of communications. Scouts may be required to enter the city as part of a larger force tasked to eliminate potential threats.

SECTION 2 — ROLE OF THE SCOUT PLATOON IN MOUT

THE DIMENSIONS OF MOUT

Scout platoons must work in four physical dimensions as they conduct reconnaissance and security tasks during MOUT:

- **The airspace over the city.** Airspace provides a rapid avenue of approach into the urbanized area. While aviation assets are unaffected by obstacles such as rubble, they must consider towers, signs, power lines, and other obstructions to flight. Scouts can locate these obstructions and assist the commander in determining how to use them to advantage.
- **Buildings.** Buildings provide cover and concealment, limit or enhance fields of observation and fire, and restrict or block movement of ground forces.
- **Streets.** Streets afford avenues of approach and are the primary means for rapid ground movement in a built-up area. Forces travelling along streets, however, are often canalized by buildings and have little space for maneuver off of the main thoroughfares.
- **Subterranean systems.** These areas, which can easily be employed as avenues of approach for

dismounted elements, include subways, sewers, cellars, and utility systems. Both attacker and defender use subterranean routes to outflank or turn enemy positions and to conduct ambushes, counterattacks, infiltration, and sustainment operations.

NOTE: In some instances, a sizable civilian population may function as a fifth dimension to MOUT, adding another unique set of operational considerations. The scout platoon's role in dealing with civilians is discussed later in this section.

The scout platoon leader and his subordinates must always be aware of the impact each operational dimension may have on their mission. For example, having to operate in one or more of the dimensions may have a significant impact on the platoon's ability to gather information. The decision to enter a MOUT environment may necessitate reorganization of the scout platoon to handle the unique operational challenges.

OPERATIONS OUTSIDE THE URBAN AREA

Scout platoon operations during MOUT often begin outside the urban area. In some situations, the enemy will not be established within the city at the onset of the campaign. Friendly forces may find themselves tasked to retain an urban area or to deny an unoccupied city to the enemy. To accomplish this, scouts are positioned to detect threat preparations to seize or occupy key urban terrain.

In other cases, the enemy may not currently be conducting MOUT because of military limitations or political restrictions. The friendly commander (as well as the scout platoon leader) must realize that this situation may change unexpectedly once restrictions are lifted or the enemy realizes he can significantly benefit from MOUT. The scout platoon can be employed to identify preparations as the enemy force postures itself for a rapid transition to MOUT. The commander can use this information to interdict the enemy before he can seize or occupy key urban terrain.

OPERATIONS WITHIN THE URBAN AREA

Once it has deployed within the city, the scout platoon seeks to pinpoint enemy defenses as well as undefended or weakly held areas that can be used to bypass or isolate the threat. The following discussion focuses on some of the operational considerations involved in the scouts' MOUT tasks.

Exploitation of surprise and enemy weakness

The friendly commander should try to exploit tactical surprise to preempt effective defensive preparations within the city. Effective employment of his scouts, using appropriate reconnaissance techniques, significantly enhances the commander's ability to achieve surprise when his unit is conducting offensive MOUT. At the same time, in using intelligence-collection and fire support assets to set necessary preconditions within the urban environment, he must avoid prematurely disclosing the presence of the scout platoon. The commander should also be aware that surprise is much more difficult for the defender to achieve in this situation; it is often possible only when the attacker suffers major failings in collection, analysis, and dissemination of intelligence.

The scout platoon can also assist the commander in concentrating sufficient combat power at decisive points within the city. Based on historical experience, the ideal attacker-defender ratio in MOUT is 4-to-1. In cases in which the attacker won despite being inferior in manpower and firepower, the

defender almost always violated one of more principals of war. Reconnaissance forces in support of an attacking force in MOUT should always be alert to the chance that the defender has not positioned his forces correctly or exhibits some other shortcoming.

The commander may be able to capitalize on such a shortcoming, or he may be able to artificially induce one. As an example, intelligence sources, including the scout platoon, have determined that the defending force relies on the local telephone exchange and military FM communications for command and control. The commander probes this weakness by directing his reconnaissance to identify key communications nodes. Once these have been pinpointed, the commander can disrupt enemy command and control by destroying the telephone system and jamming FM communications. Other types of commercial broadcasting systems (TV, radio) may also be destroyed to deny the enemy a backup communications capability. The friendly commander then exploits this situation by massing overwhelming combat power against isolated threat forces to seize key areas.

Support for combined arms teams

Combined arms teams have proven to be the critical ingredient for success in MOUT. Consisting of armor, infantry, engineers, and field artillery, these teams provide the commander with a range of capabilities necessary to operate successfully in an urban setting. For example, tanks, with the infantry elements protecting them, can serve as an assault force, delivering concentrated, sustained fire to reduce stubbornly held strongpoints. In addition to conducting direct assaults, combined arms teams built around heavy forces are employed to isolate an urban area or, conversely, to prevent isolation of an area by the enemy.

Scout platoons can be employed to focus on avenues of approach that support combined arms teams. Scouts can also identify key terrain along these avenues that must be seized in advance to facilitate the movement of the combined arms maneuver elements. Examples of key urban terrain may include a series of high-rise buildings, the intersection of major highways, or a critical bridge or tunnel providing access to the urban area.

Role of scouts in employment of fires

The scout platoon can also play an important role in employing fires during MOUT. Reconnaissance assets direct fires, guide precision munitions, and discriminate between threat forces and civilians. They can accomplish this by virtue of effective positioning on the battlefield and effective use of their acquisition capabilities.

Artillery-delivered indirect fire has traditionally been a significant factor in successful MOUT execution. Fire support has proved to be the primary means by which the commander can interdict enemy supply operations, as well as prevent the reinforcement and evacuation of enemy troops. In such instances, fires are placed on routes leading into and out of the city rather than within the built-up area itself.

During offensive operations, the commander must ensure that precision fires are employed to avoid causing problems for his own forces. Indiscriminate bombardment can degrade the ability of friendly forces to conduct ground maneuver while simultaneously providing the enemy with barricades, construction or barrier materials, and extensive cover and concealment. Indiscriminate or inaccurate placement of fires can also result in significant collateral damage. In addition to causing civilian casualties, friendly fires can seriously damage the support infrastructure of the city or create natural disasters such as inadvertent release of toxic gases from a commercial chemical facility.

In support of his indirect fire plan, the MOUT commander uses the scout platoon both to accurately place fires on enemy positions and to prevent the problems associated with inaccurate fires, such as collateral damage. Scouts are especially valuable in preventing fratricide by helping to ensure that the commander remains aware of the location of friendly and enemy forces within the built-up area.

Isolating the enemy force

The primary focus of the scout platoon during MOUT is driven by the overriding requirement to isolate the opposing force. No single factor in MOUT has proven more important to success than isolation of the urban area. The attacker always wins when the defending force is totally isolated. Even partial isolation of the enemy force normally results in victory for the side that is able to accomplish it.

The scout platoon provides the commander with information that will allow him to determine how he can isolate the enemy. Scout platoon operations also key on identifying when and where the enemy plans to defend a city. The commander uses this reconnaissance information to create opportunities to exploit the four dimensions of MOUT for the purpose of achieving a significant tactical advantage. He can then isolate the enemy by massing overwhelming combat power at decisive points and by bypassing or conducting economy of force operations in areas that are not decisive.

Interaction with the civilian populace

The scout platoon also assists the commander in leveraging the fifth dimension of MOUT, the local civilian populace. The commander must always remain aware of his responsibilities to civilians; this factor cannot be minimized in the age of modern media. Scouts perform several roles to assist the commander in his dealing with the civilian population. They conduct reconnaissance to ensure that collateral damage resulting from tactical operations is limited to the absolute minimum. They can locate civilians who have sought refuge in the urban area and identify facilities that sustain the populace. Scouts also assist in determining whether or not civilians within a built-up area pose a threat to friendly forces.

SECTION 3 — CONDUCT OF MOUT

This section focuses on operational considerations the scout platoon will face when it conducts MOUT. As in other operational environments, the platoon leader and his subordinate leaders must learn to tailor their planning, preparation, and execution to the specific conditions they encounter. Refer to the discussion of the scout platoon's role in the urban environment in [Section 2](#) of this appendix.

MOUT are conducted most frequently as light/heavy operations, with the scout platoon and armor and mechanized forces supporting light infantry elements. Planning for the light/heavy force in a MOUT environment is the same as in any other terrain. CFVs are most effective when employed in terrain that allows for offensive maneuver. In some situations, it may be possible to keep armored forces around the perimeter of the town rather than to expose them to the inherent dangers in the built-up area. Armored vehicles can then operate outside the town while still providing adequate fire support to the infantry.

VEHICLE CAPABILITIES AND LIMITATIONS

Scout platoons equipped with the CFV can be employed in built-up areas to assist dismounted forces in seizing and clearing streets and buildings. Scout platoons equipped with the HMMWV do not normally operate inside the built-up area because of their lack of armor protection; they are used to secure the avenues of approach around the perimeter of the area. Both the CFV and the HMMWV can provide suppressive fires for the initial assault on the built-up area.

CFV capabilities. The CFV has these capabilities related to MOUT:

- It is armed with the 25-mm cannon and 7.62-mm coax machine gun.
- It is capable of 60-degree elevation, allowing it to engage targets on the upper floors of tall buildings.
- It can employ 25-mm TP-T or HEI-T ammunition to penetrate buildings.
- It provides armor protection for crew and passengers.
- It is equipped with multiple FM radios.
- It can assist in MEDEVAC/CASEVAC operations.
- It can assist in resupply operations.

CFV limitations. The CFV has these vulnerabilities related to MOUT:

- It is restricted primarily to streets and lacks maneuverability inside built-up areas.
- There is dead space around the CFV into which the vehicle cannot fire its weapons.
- It is vulnerable to enemy infantry firing antiarmor weapons from cellars and drains.
- It is dependent on infantry for all-around protection.

HMMWV capabilities. The HMMWV has these capabilities related to MOUT:

- It is armed with the caliber .50 heavy machine gun and/or the MK-19 40-mm machine gun with automatic grenade launcher.
- It can suppress and destroy light armor vehicles.
- It is highly mobile and has a small thermal signature.
- It is equipped with multiple FM radios.
- It presents fewer logistical problems than the CFV.
- It can operate in narrow streets.

HMMWV limitations. The HMMWV has these vulnerabilities in MOUT:

- It provides armor protection only against small arms.
- It lacks the ability to transport infantry soldiers.
- It has no antiarmor capability.

THE THREE PHASES OF MOUT

Light infantry forces conduct the attack of a built-up area in three phases: isolating the area, gaining a foothold, and seizing and clearing the objective. The scout platoon can support all three phases. Normally, it will operate as part of the fire support element or the security force.

Isolating the objective. The isolated area may be a building, village, small town, or large built-up area. The scout platoon is effective in this phase of the operation; operating outside the town allows the armored force to use long-range fires, speed, and mobility. The defender often positions forces outside the town to disrupt an attack and to limit friendly reconnaissance and mobility; CFVs may be able to prevent these enemy forces from accomplishing their goals and from withdrawing into the town. The scout platoon surrounds the objective by seizing key terrain and covering enemy avenues of approach (see [Figure D-1](#)). In addition to security, scout platoon tasks may include the following:

- Preventing enemy forces from escaping.
- Preventing reinforcement of the built-up area.
- Protecting the assault force from counterattack.
- Calling for and adjusting indirect fires.

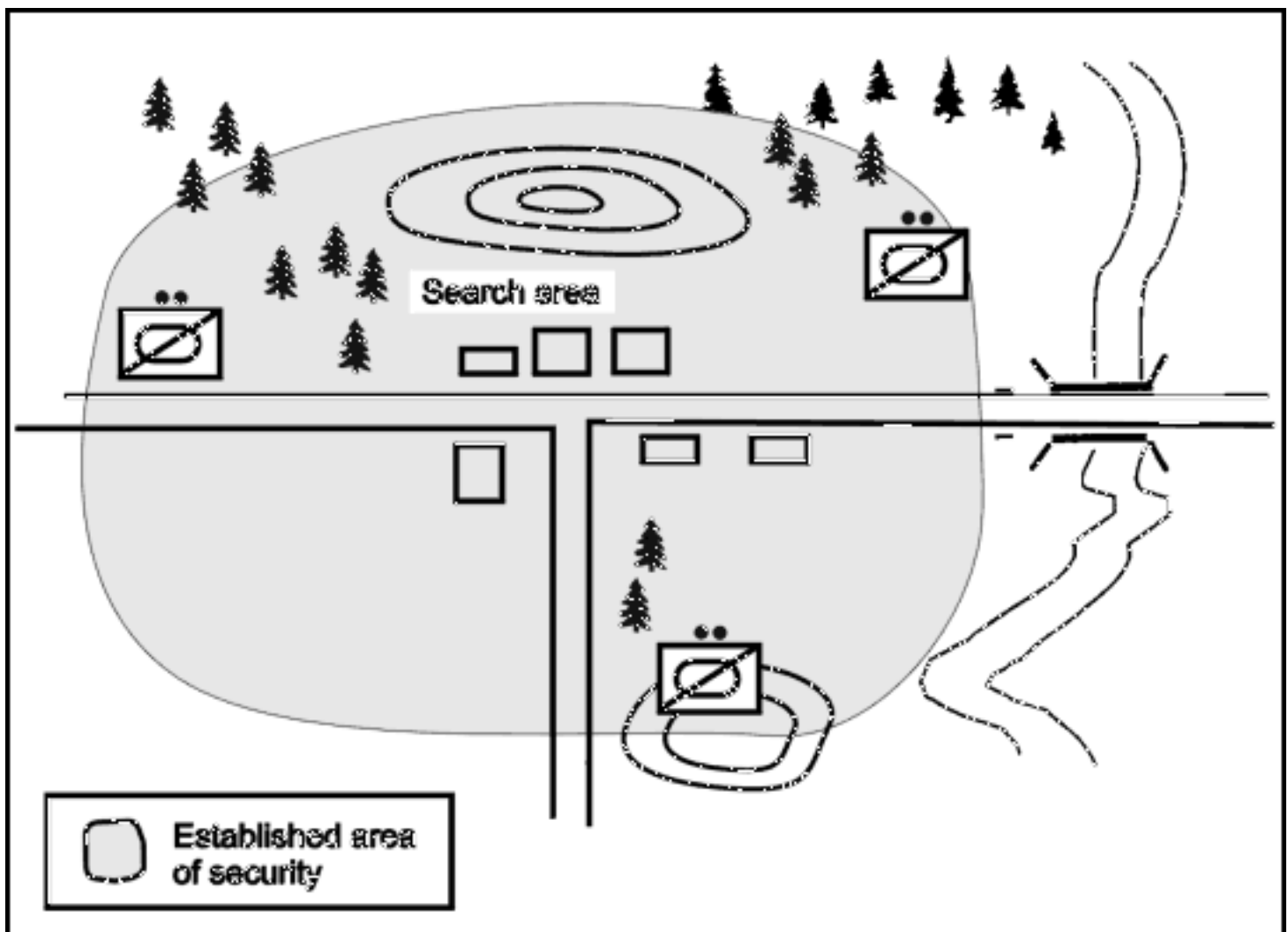

Figure D-1. Isolating the objective in MOUT.

Gaining a foothold. The scout platoon can use its sights, including thermals, to conduct long-range reconnaissance and to locate enemy positions and/or vehicles during periods of limited visibility. The platoon can also provide fire support for infantry assaulting the objective. During the assault, the attacking force penetrates the area on a narrow front, concentrating all available supporting fires on the entry point. In support of the assault, scout platoon tasks include the following:

- Attack by fire.
- Support by fire.
- Attack with the infantry.
- Coordinate and control indirect fires.

Attack by fire. The CFVs attack by fire while the infantry assaults the objective. Once the assault force establishes a foothold, CFVs move forward to provide close-in support. This method is used when enemy antiarmor fires or obstacles block the only possible armor avenue of approach.

Support by fire. CFVs conduct support by fire during the assault, this may include covering critical areas on the assault force's flanks. Once the assault force establishes a foothold, CFVs move forward to provide close-in support (see [Figure D-2](#)).

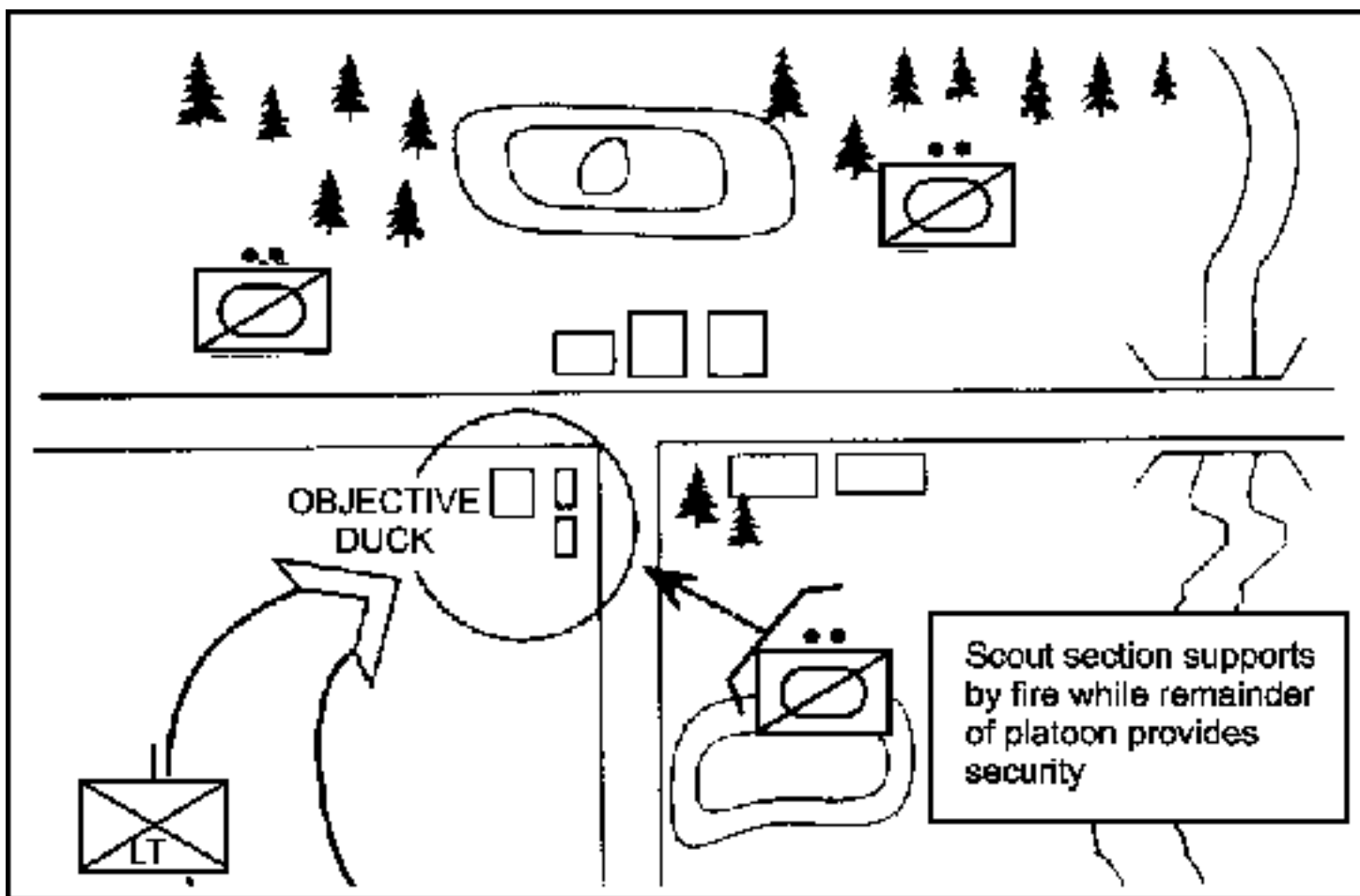

Figure D-2. Gaining a foothold in MOUT (scout platoon conducts support by fire).

Attack with the infantry. CFVs and the infantry advance together, with the infantry moving behind the CFVs for protection from small arms fire. Infantry squads or fire teams protect the CFVs from the enemy's

hand-held antiarmor weapons (see [Figure D-3](#)). Attacking with infantry is difficult to coordinate and execute because of differences in speed between the mounted and dismounted forces.

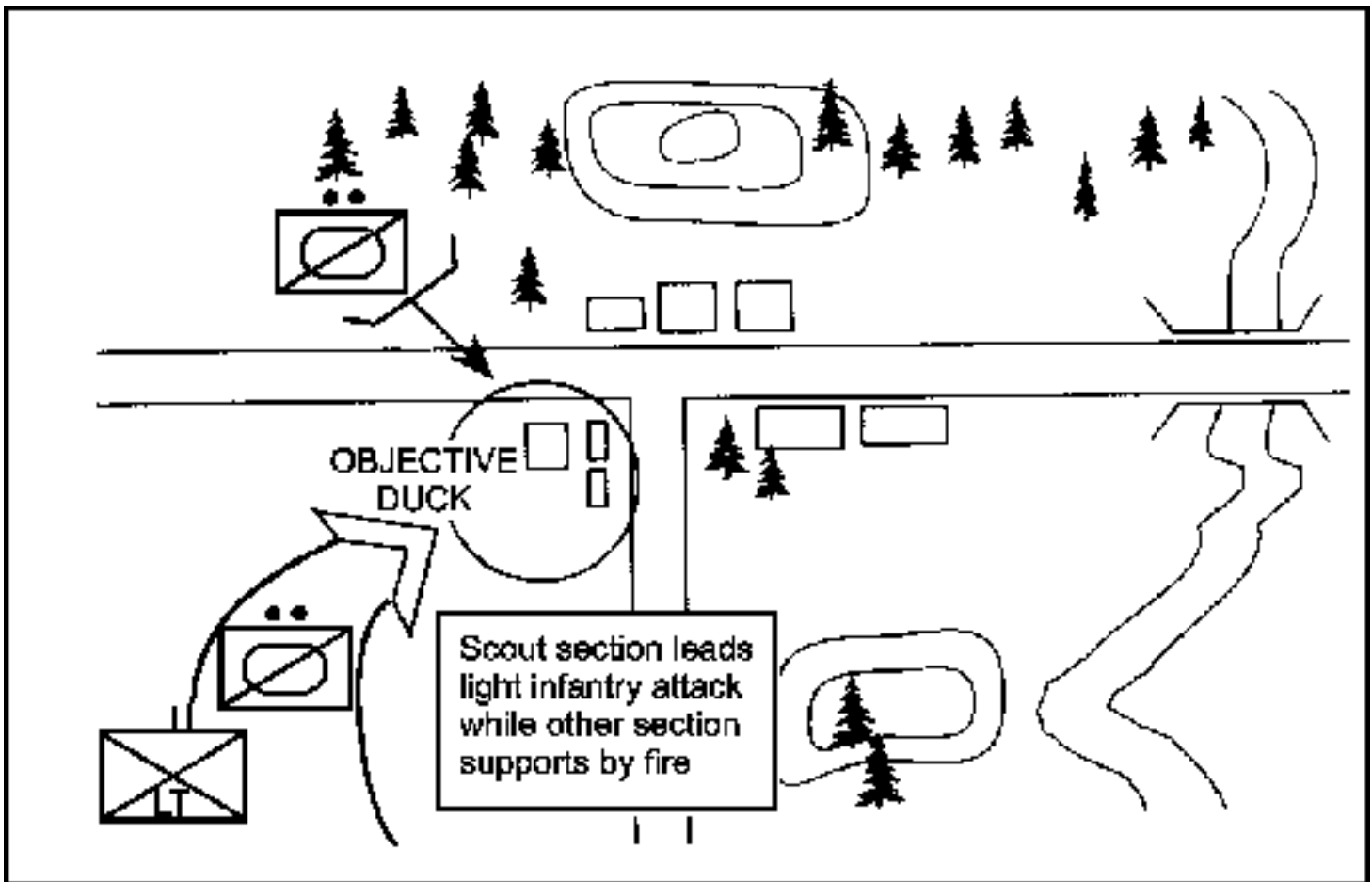

Figure D-3. Gaining a foothold in MOUT (scout platoon attacks with infantry).

Seizure and clearance. Once the infantry seizes its initial foothold, the scout platoon provides supporting fires while the infantry clears each building. Because of the danger of ambush, scout vehicles should support by fire from cleared positions rather than moving ahead of the infantry. They can sometimes provide fire support without entering the built-up area.

Because target identification and fire control measures change rapidly as clearance progresses, CFVs in the built-up area must be closely controlled by the infantry leader in charge (see [Figure D-4](#)). Scout vehicles provide suppressive fires to allow the infantry to establish a foothold in each building. To isolate buildings, vehicles engage known or suspected enemy locations. Once the infantry is inside the building, the scout vehicles continue to suppress enemy positions on other floors or in adjacent buildings. Specific actions of the scout platoon in clearing a building include the following:

- Firing into the upper stories of the buildings to drive enemy forces to lower floors or the basement, where the infantry can trap and destroy them.
- Suppressing and destroying enemy weapons and personnel.
- Providing antitank protection.
- Using direct fires to open holes in walls and reduce barricades.

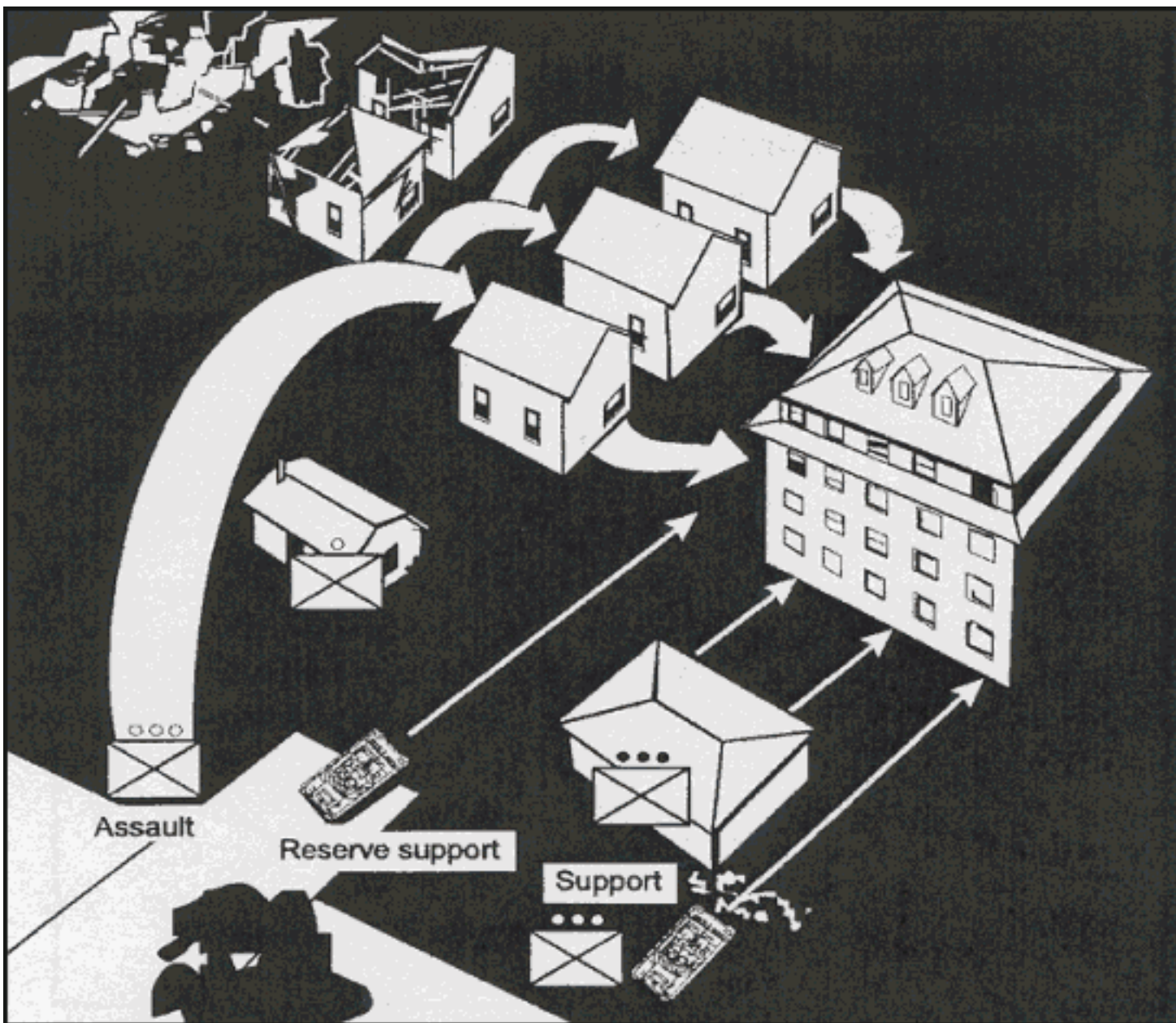

Figure D-4. Scout section supports isolation and seizure of a building.

Seizure and clearance operations can range between two extremes: a systematic, block-by-block, house-by-house reduction of the built-up area or a rapid advance with friendly forces concentrating on seizing and clearing critical areas and buildings. (Figure D-5 shows a CFV supporting an infantry squad in seizing and clearing an urban area.) The scout platoon's role is roughly the same in either type of operation. These guidelines apply:

- Clearing streets:
 - CFVs lead, closely followed and supported by infantry.
 - CFVs work in pairs.
 - CFVs concentrate fires on windows and rooftops.
 - Infantry protects CFVs from close-in fires.
 - Infantry moves alongside or directly behind CFVs and scans for potential antiarmor positions.
- Seizing and clearing buildings:
 - CFVs provide suppressive fires, concentrating on windows, doorways, and rooftops.

-- CFVs create holes in building walls to allow the infantry to enter through unexpected entrances.

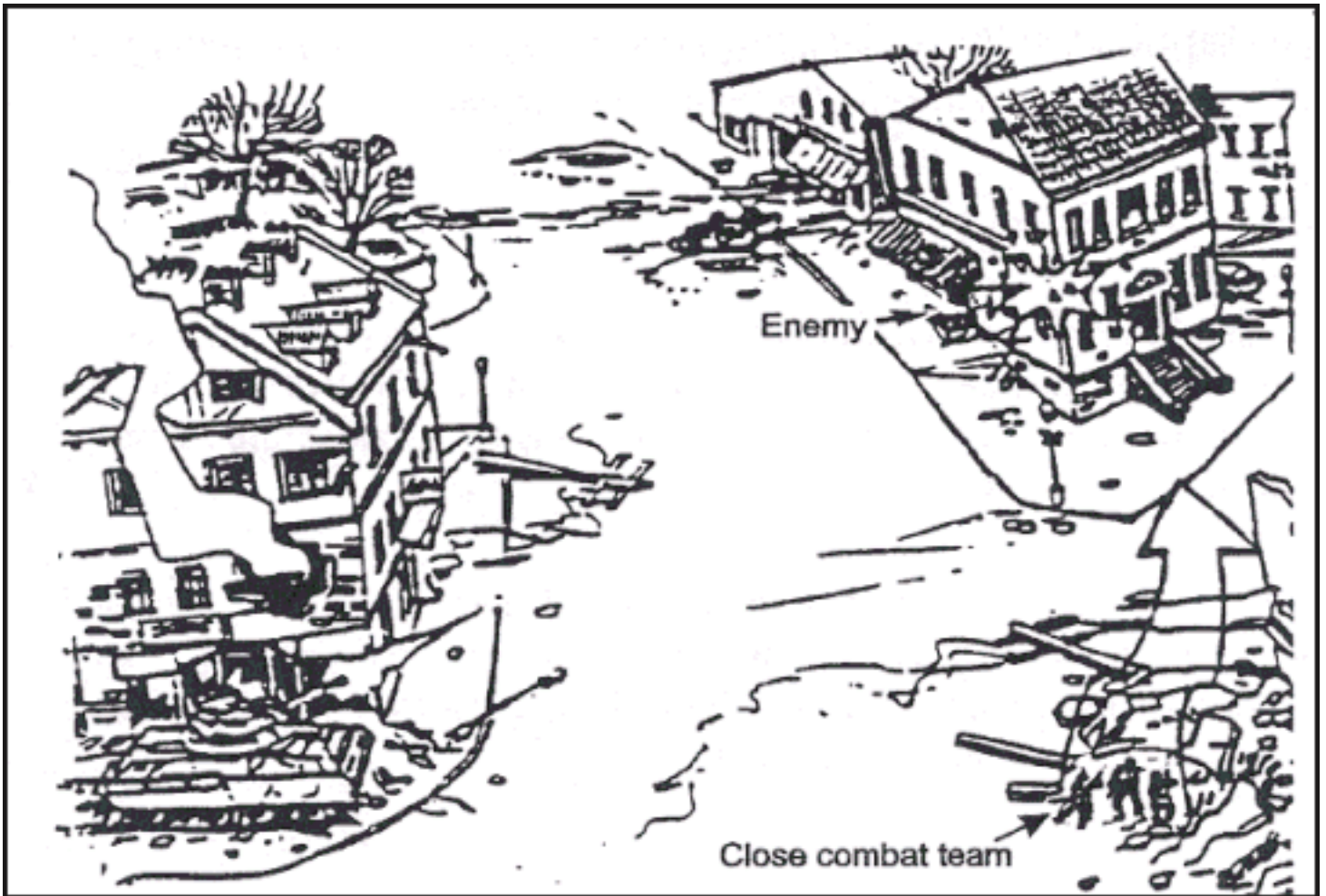

Figure D-5. CFV provides support as infantry squad seizes and clears a building.

COMMAND, CONTROL, AND COMMUNICATIONS

Combat power is difficult to mass during MOUT because fighting is isolated. Command and control are further aggravated because units can easily become separated. Such conditions make it necessary to decentralize the fight down to the smallest unit. These small units, scout sections and infantry squads, must communicate continuously and effectively if they are to survive and win on the urban battlefield.

Visual signals. Visual signals are the most effective and reliable means of communications between the infantry force and the scout vehicles. Targets are identified with tracer fire, grenade launcher rounds, smoke grenades, VS-17 panels, or hand-and-arm signals. Visual signals are used to trigger specific actions such as initiating fires, lifting or shifting fires, moving forward to the next position, and providing smoke obscuration.

FM radio and wire. The infantry leader and scout vehicles can use FM radios and/or land lines to communicate while stationary. FM communications may be affected by the terrain; land lines can be used when FM communications are disrupted. To use land lines, run wire through the hatch to the inside of the CFV or connect it to the sponson box on the rear of the vehicle. A TA-1 is used to relay fire control instructions to the vehicle.

FIRE SUPPORT

Indirect fires are most effective when used against open spaces within built-up areas; high-trajectory indirect fires are more effective than lower-trajectory fires. Because of these factors, mortars are normally more desirable than artillery for indirect fire support in MOUT.

Scouts can play a valuable role as the link between infantry squads and platoons and the mortars of the cavalry troop or armored battalion. Scout sections or squads are trained to call for and adjust indirect fires from these assets in support of the infantry's attack.

[RDL](#)[Table of](#)[Document](#)[Download](#)[Homepage](#) [Contents](#) [Information](#) [Document](#)

APPENDIX E

Environmental Protection

Protection of natural resources has become an ever-increasing concern. It is the responsibility of all unit leaders to decrease, and if possible eliminate, damage to the environment when conducting all types of operations. This appendix focuses on measures the scout platoon must understand and implement to accomplish that objective.

CONTENTS

[Section 1](#) [Environmental Risk Management Process](#)

[Section 2](#) [Environmental Risk Assessment Worksheet](#)

SECTION 1 — ENVIRONMENTAL RISK MANAGEMENT PROCESS

Environmental risk management parallels safety risk management and is based on the same philosophy and principles. (**NOTE:** Refer to the discussion of safety risk management in [Appendix F](#) of this manual.) The environmental risk assessment and management process consists of the six steps outlined in the following paragraphs.

STEP 1 - IDENTIFY HAZARDS

The platoon leader must identify potential sources of environmental degradation during his analysis of METT-TC factors. These environmental hazards are conditions with the potential for polluting air, soil, or water and/or destroying cultural or historical structures, sites, or artifacts.

STEP 2 - ASSESS THE HAZARDS

Leaders of the scout platoon can use the environmental risk assessment worksheet shown in [Figure E-1](#) to analyze the potential severity of environmental degradation for each training activity. The worksheet allows them to quantify the risk to the environment as extremely high, high, medium, or low. The risk impact value is an indicator of these levels of severity.

Environmental Risk Assessment Worksheet

Environmental area:	Rating:					
Unit Operations:	Risk Impact:					
Movement of heavy vehicles/systems	5	4	3	2	1	0
Movement of personnel and light vehicles/systems	5	4	3	2	1	0
Assembly area activities	5	4	3	2	1	0
Field maintenance of equipment	5	4	3	2	1	0
Garrison maintenance of equipment	5	4	3	2	1	0

Overall Environmental Risk Assessment Form

	Movement of heavy vehicles/systems	Movement of personnel and light vehicles/systems	Assembly area activities	Field maintenance of equipment	Garrison maintenance of equipment	Risk impact value
Air pollution						
Archeological and historical sites						
Hazardous material/waste						
Noise pollution						
Threatened/endangered species						
Water pollution						
Wetland protection						
OVERALL RISK IMPACT VALUE						

Risk Impact Value Categories

Category	Range (Points)	Environmental Damage Risk	Decision-maker
Low	0-58	Little or none	Appropriate level
Medium	59-117	Minor	Appropriate level
High	118-149	Significant	Division commander
Extremely High	150-175	Severe	MACOM commander

Figure E-1. Figure E-1. Environmental risk assessment worksheet.**STEP 3 - MAKE ENVIRONMENTAL RISK DECISIONS**

Based on the results of the risk assessment, the scout platoon leader makes decisions and develops measures to reduce significant environmental risks. Risk decisions are made at a level of command that corresponds to the degree of risk.

STEP 4 - BRIEF THE CHAIN OF COMMAND

Leaders should brief all responsible individuals and agencies (to include the installation environmental office, if applicable) on the proposed operational and training plans and on pertinent high-risk environmental factors.

STEP 5 - IMPLEMENT CONTROLS

The scout platoon leader and subordinate leaders implement environmental protection measures at all stages of operational planning, preparation, and execution. They integrate these measures into plans, orders, SOPs, training performance standards, and rehearsals.

STEP 6 - SUPERVISE

The platoon leader must enforce environmental protection standards during supervision of all training activities.

SECTION 2 — ENVIRONMENTAL RISK ASSESMENT WORKSHEET

To use the environmental risk assessment worksheet (see [Figure E-1](#)) for a specific operation or training event, the scout platoon leader and subordinate leaders first determine the impact level for each of five operational factors. These activities, listed in the top part of the worksheet, are movement of heavy vehicles and equipment; movement of personnel and light vehicles and equipment; assembly area activities; field maintenance activities; and garrison maintenance activities. The risk impact is assigned a value from 0 (lowest risk) to 5 (highest risk) for each activity.

The second part of the worksheet allows leaders to assess the risk impact of the platoon's activities in seven critical areas of environmental concern. The leaders determine which of the five operational activities will affect each critical area and enter the corresponding risk impact value. For example, the platoon leader determines that movement of heavy vehicles (which he has assigned a risk value of 5), "light" movement (a value of 2), and assembly area activities (a value of 4) will affect air pollution during the platoon's upcoming training exercise. He enters those values in the appropriate columns, then adds them together for a total risk impact value of 11 for air pollution. He repeats this process for the other environmental areas of concern.

The total of the risk impact values for the seven environmental areas is the overall risk impact value for the operation or exercise. As noted, the overall point total serves as an indicator of risk impact in four categories: low, medium, high, and extremely high. The worksheet summarizes the environmental

damage risk for these categories.

The worksheet also lists the level at which environmental protection decisions are made for each risk impact category. As with other types of risk assessment, such decisions must be made, and appropriate controls implemented, at the proper level of command. The decision-maker (whether it is the platoon leader, a subordinate leader, or a higher commander) uses the risk impact values as a guide in ensuring that the environment in the operational area is protected and preserved.

APPENDIX F

Risk Management

Risk is the chance of injury or death for individuals and damage to or loss of vehicles and equipment. Risks, and/or the potential for risks, are always present in every combat and training situation the scout platoon faces. Risk management must take place at all levels of the chain of command during each phase of every operation; it is an integral part of all tactical planning. The scout platoon leader, his NCOs, and all other platoon soldiers must know how to use risk management, coupled with fratricide reduction measures, to ensure that the mission is executed in the safest possible environment within mission constraints.

The primary objective of risk management is to help units protect their combat power through accident prevention, enabling them to win the battle quickly and decisively, with minimum losses. This appendix outlines the process that leaders can use to identify hazards and implement a plan to address each identified hazard. It also includes a detailed discussion of the responsibilities of the platoon's leaders and individual soldiers in implementing a sound risk management program. For additional information on risk management, refer to FM 100-14.

CONTENTS

[Section 1 Risk Management Procedures](#)

[Section 2 Implementation Responsibilities](#)

SECTION 1 — RISK MANAGEMENT PROCEDURES

This section outlines the five steps of risk management. Leaders of the scout platoon must always remember that the effectiveness of the process depends on situational awareness. They should never approach risk management with "one size fits all" solutions to the hazards the platoon will face. Rather, in performing the steps, they must keep in mind the essential tactical and operational factors that make each situation unique.

STEP 1 - IDENTIFY HAZARDS

A hazard is a source of danger. It is any existing or potential condition that could entail injury, illness, or death of personnel; damage to or loss of equipment and property; or some other sort of mission

degradation. Tactical and training operations pose many types of hazards.

The scout platoon leader must identify the hazards associated with all aspects and phases of the platoon's mission, paying particular attention to the factors of METT-TC. Risk management must never be an afterthought; leaders must begin the process during their troop-leading procedures and continue it throughout the operation.

[Figure F-1](#) lists possible sources of risk that the scout platoon might face during a typical tactical operation. The list is organized according to the factors of METT-TC.

SOURCES OF BATTLEFIELD RISK
<p>MISSION</p> <ul style="list-style-type: none"> ● Duration of the operation. ● Complexity/clarity of the plan. (Is the plan well developed and easily understood?) ● Proximity and number of maneuvering units.
<p>ENEMY</p> <ul style="list-style-type: none"> ● Knowledge of the enemy situation. ● Enemy capabilities. ● Availability of time and resources to conduct reconnaissance.
<p>TERRAIN AND WEATHER</p> <ul style="list-style-type: none"> ● Visibility conditions, including light, dust, fog, and smoke. ● Precipitation and its effect on mobility. ● Extreme heat or cold. ● Additional natural hazards (broken ground, steep inclines, water obstacles).
<p>TROOPS</p> <ul style="list-style-type: none"> ● Equipment status. ● Experience the units conducting the operation have working together. ● Danger areas associated with the platoon's weapon systems. ● Soldier/leader proficiency. ● Soldier/leader rest situation. ● Degree of acclimatization to environment. ● Impact of new leaders and/or crewmembers.
<p>TIME AVAILABLE</p> <ul style="list-style-type: none"> ● Time available for troop-leading procedures and rehearsals by subordinates. ● Time available for PCCs/PCIs.

CIVILIAN CONSIDERATIONS

- Applicable ROE and/or ROI.
- Potential stability and/or support operations involving contact with civilians (such as NEOs, refugee or disaster assistance, or counterterrorism).
- Potential for media contact/inquiries.

Figure F-1. Examples of potential hazards.**STEP 2 - ASSES HAZARDS TO DETERMINE RISKS**

Hazard assessment is the process of determining the direct impact of each hazard on an operation (in the form of hazardous incidents). Use the following steps:

- Determine which hazards can be eliminated or avoided.
- Assess each hazard that cannot be eliminated or avoided to determine the probability that the hazard can occur.
- Assess the severity of hazards that cannot be eliminated or avoided. Severity, defined as the result or outcome of a hazardous incident, is expressed by the degree of injury or illness (including death), loss of or damage to equipment or property, environmental damage, or other mission-impairing factors (such as unfavorable publicity or loss of combat power).
- Taking into account both the probability and severity of a hazard, determine the associated risk level (extremely high, high, moderate, and low). [Figure F-2](#) summarizes the four risk levels.
- Based on the factors of hazard assessment (probability, severity, and risk level, as well as the operational factors unique to the situation), complete the risk management worksheet. [Figure F-3](#) outlines instructions for the worksheet. [Figure F-4](#) shows an example of a completed risk management worksheet.

RISK LEVEL	MISSION EFFECTS
Extremely high (E)	Mission failure if hazardous incidents occur in execution.
High (H)	Significantly degraded mission capabilities in terms of required mission standards. Not accomplishing all parts of the mission or not completing the mission to standard (if hazards occur during mission).
Moderate (M)	Expected degraded mission capabilities in terms of required mission standards. Reduced mission capability (if hazards occur during the mission).
Low (L)	Expected losses have little or no impact on mission success.

Figure F-2. Risk levels and impact on mission execution.

WORKSHEET BLOCK	INSTRUCTIONS
A through E	These blocks are self-explanatory.
1 (identify hazards)	Review the applicable METT-TC factors for the mission or task. Leaders should use all available resources in making the identification, including historical lessons learned, intuitive analysis, experience, and judgment.
2 (assess hazards)	Determine the initial risk level for each hazard, applying criteria outlined in Figure F-2.
3 (develop controls)	For each hazard, develop one or more controls that will either eliminate the hazard or reduce the risk (probability and/or severity) of a hazardous incident.
4 (determine residual risk)	Determine the residual risk for each hazard based on the initial risk level and the controls developed for each hazard (listed in Block 3)
5 (implement controls)	Determine how each control will be put into effect or communicated to personnel/unit who will make it happen. Methods may include using written or oral instructions; tactical, safety, or garrison SOPs; and/or rehearsals.
F (overall mission/task risk)	Select the highest residual risk level in Block 4 and circle it in this block; this is the overall mission or task risk level. The applicable commander decides whether or not the controls developed for the risk are sufficient and whether to accept the level of residual risk. He must measure the residual risk against mission expectations. If the risk is too great to continue the mission or task, the commander must develop additional controls or modify or reject the designated COA for the mission or task.
Supervise and evaluate	The last step of the risk management process, though not listed on the worksheet, is nonetheless critical. Plan how each control will be monitored for implementation (such as through continuous supervision and/or spot checks). Determine whether the controls are working and how they can be improved. Pass on lessons learned to the unit and higher.

Figure F-3. Instructions for risk management worksheet.

A. Mission or task Conduct a hasty attack		B. Date/time group Begin: 031035R NOV 98 End: 030600R NOV 98		C. Date prepared: 29 OCT 98
D. Prepared by (rank, last name, duty position):				
E. Task: Conduct obstacle breaching operations				
1 - Identify hazard	2 - Assess hazard	3 - Develop controls	4 - Residual risk	5 - Implement controls
Obstacle	High (H)	Develop and use obstacle reduction plan	Low (L)	Unit TSOP, OPORD, training handbook
Inexperienced soldiers	High (H)	Additional instruction and increased supervision	Moderate (M)	Modified training schedule, additional instruction
Limited visibility operations	Moderate (M)	Use night vision devices, IR markers on vehicles	Low (L)	Unit TSOP, OPORD
Steep cliffs	High (H)	Rehearse use of climbing ropes	Moderate (M)	Per FM 90-6 and/or TC 90-6-1
Insufficient planning time	High (H)	Conduct concurrent planning and preparations	Moderate (M)	OPORD, troop-leading procedures
F. Overall risk level (after controls are implemented; circle one)				
LOW (L) MODERATE (M) HIGH (H) EXTREMELY HIGH (E)				

Figure F-4. Example risk management worksheet.

STEP 3 - DEVELOP CONTROLS AND MAKE RISK DECISIONS

Developing controls

After assessing each hazard, develop one or more controls that will either eliminate the hazard or reduce the risk (probability and/or severity) of potential hazardous incidents. When developing controls, consider the reason for the hazard, not just the hazard by itself.

Making risk decisions

A key element in the process of making a risk decision is determining whether accepting the risk is justified or, conversely, is unnecessary. The decision-maker (the scout platoon leader, if applicable) must compare and balance the risk against mission expectations. He alone decides if the controls are sufficient and acceptable and whether to accept the resulting residual risk. If he determines the risk is unnecessary, he directs the development of additional controls or alternative controls; as another option, he can modify, change, or reject the selected COA for the operation.

STEP 4 - IMPLEMENT CONTROLS

Controls are the procedures and considerations the unit uses to eliminate hazards or reduce their risk. Implementing controls is the most important part of the risk management process; this is the chain of command's contribution to the safety of the unit. Implementing controls includes coordination and communication with appropriate superior, adjacent, and subordinate units and with individuals executing the mission. The scout platoon leader must ensure that specific controls are integrated into OPLANs, OPODs, SOPs, and rehearsals. The critical check for this step is to ensure that controls are converted into clear, simple execution orders understood by all levels.

If the leaders have conducted a thoughtful risk assessment, the controls will be easy to implement, enforce, and follow. Examples of risk management controls include the following:

- Thoroughly brief all aspects of the mission, including related hazards and controls.
- Conduct thorough PCCs and PCIs.
- Allow adequate time for rehearsals at all levels.
- Drink plenty of water, eat well, and get as much sleep as possible (at least 4 hours in any 24-hour period).
- Use buddy teams.
- Enforce speed limits, use of seat belts, and driver safety.
- Establish recognizable visual signals and markers to distinguish maneuvering units.
- Enforce the use of ground guides in assembly areas and on dangerous terrain.
- Establish marked and protected sleeping areas in assembly areas.
- Limit single-vehicle movement.
- Establish SOPs for the integration of new personnel.

STEP 5 - SUPERVISE AND EVALUATE

During mission execution, it is imperative for leaders to ensure that risk management controls are properly understood and executed. Leaders must continuously evaluate the unit's effectiveness in managing risks to gain insight into areas that need improvement.

Supervision

Leadership and unit discipline are the keys to ensuring that effective risk management controls are implemented. All leaders are responsible for supervising mission rehearsals and execution to ensure standards and controls are enforced. In particular, NCOs must enforce established safety policies as well as controls developed for a specific operation or task. Techniques include spot checks, inspections, SITREPs, confirmation briefs, buddy checks, and close supervision.

During mission execution, leaders must continuously monitor risk management controls, both to determine whether they are effective and to modify them as necessary. Leaders must also anticipate, identify, and assess new hazards. They ensure that imminent danger issues are addressed on the spot and that ongoing planning and execution reflect changes in hazard conditions.

Evaluation

Whenever possible, the risk management process should also include an after-action review (AAR) to assess unit performance in identifying risks and preventing hazardous situations. Leaders should then incorporate lessons learned from the process into unit SOPs and plans for future missions.

SECTION 2 — IMPLEMENTATION RESPONSIBILITIES

Leaders and individuals at all levels are responsible and accountable for managing risk. They must ensure that hazards and associated risks are identified and controlled during planning, preparation, and execution of operations. The scout platoon leader and his senior NCOs must look at both tactical risks and accident risks. The same risk management process is used to manage both types. The scout platoon leader alone determines how and where he is willing to take tactical risks. With the assistance of his PSG, NCOs, and individual soldiers, the platoon leader manages accident risks.

Sometimes, despite the need to advise higher headquarters of a risk taken or about to be assumed, the risk management process may break down. Such a failure can be the result of several factors; most often, it can be attributed to the following:

- The risk denial syndrome in which leaders do not want to know about the risk.
- A soldier who believes that the risk decision is part of his job and does not want to bother his platoon leader or section leader.
- Outright failure to recognize a hazard or the level of risk involved.
- Overconfidence on the part of an individual or the unit in the capability to avoid or recover from a hazardous incident.
- Subordinates not fully understanding the higher commander's guidance regarding risk decisions.

The scout platoon leader gives the platoon direction, sets priorities, and establishes the command climate

(values, attitudes, and beliefs). Successful preservation of combat power requires him to embed risk management into individual behavior. To fulfill this commitment, the platoon leader must exercise creative leadership, innovative planning, and careful management. Most important, he must demonstrate support for the risk management process. The scout platoon leader and others in the platoon chain of command can establish a command climate favorable to risk management integration by taking the following actions:

- Demonstrate consistent and sustained risk management behavior through leading by example and by stressing active participation throughout the risk management process.
- Provide adequate resources for risk management. Every leader is responsible for obtaining the assets necessary to mitigate risk and for providing them to subordinate leaders.
- Understand their own and their soldier's limitations, as well as their unit's capabilities.
- Allow subordinates to make mistakes and learn from them.
- Prevent a "zero defects" mindset from creeping into the platoon's culture.
- Demonstrate full confidence in subordinates' mastery of their trade and their ability to execute a chosen COA.
- Keep subordinates informed.
- Listen to subordinates.

For the platoon leader, his subordinate leaders, and individual soldiers alike, responsibilities in managing risk include the following:

- Make informed risk decisions; establish and then clearly communicate risk decision criteria and guidance.
- Establish clear, feasible risk management policies and goals.
- Train the risk management process. Ensure that subordinates understand the who, what, when, where, and why of managing risk and how these factors apply to their situation and assigned responsibilities.
- Accurately evaluate the platoon's effectiveness, as well as subordinates' execution of risk controls during the mission.
- Inform higher headquarters when risk levels exceed established limits.

APPENDIX G

Fratricide Prevention

Fratricide is defined as the employment of friendly weapons that results in the unforeseen and unintentional death or injury of friendly personnel or damage to friendly equipment. Fratricide prevention is the commander's responsibility. He is assisted by all leaders across all operating systems in accomplishing this mission. This appendix focuses on actions the scout platoon leader and his subordinate leaders can take with current resources to reduce the risk of fratricide.

More than any other maneuver element, scouts are at risk of being victims of fratricide. The scout platoon is particularly vulnerable because it often maneuvers in dispersed elements forward and to the flanks of other friendly combat forces. In a battalion, company teams often do not keep up with the plan or with the disposition of the scouts. For these reasons, situational awareness on the part of all scout leaders, particularly the platoon leader, is critical not only to mission success but also to survival.

In any tactical situation, it is critical that scouts know where other friendly elements are operating. With this knowledge, they must anticipate dangerous conditions and take steps to either avoid or mitigate them. The platoon leader must always be vigilant of changes and developments in the situation that may place his elements in danger. He must also ensure that all scout section or squad positions are constantly reported to higher headquarters so that all other friendly elements are aware of where the scouts are and what they are doing. At troop and battalion level, no-fire areas can be designated to control friendly direct and indirect fire into areas in which scouts are or will be operating. When the platoon leader perceives a potential fratricide situation, he must personally use the higher net to coordinate directly with the friendly element involved.

CONTENTS

[Section 1](#) [The Role of Training](#)

[Section 2](#) [Effects of Fratricide](#)

[Section 3](#) [Causes of Fratricide](#)

[Section 4](#) [Fratricide Risk Assessment](#)

[Section 5](#) [Fratricide Prevention Measures](#)

[Section 6](#) [Stopping a Friendly Fire Incident](#)

SECTION 1 — THE ROLE OF TRAINING

The underlying principle of fratricide prevention is simple: Leaders who know where their soldiers are, and where they want them to fire, can keep those soldiers alive to kill the enemy. At the same time, leaders must avoid at all costs any reluctance to employ, integrate, and synchronize all required operating systems at the critical time and place. They must avoid becoming tentative out of fear of fratricide; rather, they strive to eliminate fratricide risk through tough, realistic, combined arms training in which each soldier and unit achieves the established standard.

Training allows units and soldiers to make mistakes, with the goal of reducing or eliminating the risk of errors occurring in combat. A key role of the scout platoon training program is to teach vehicle crews what targets to engage and when to engage them. Just as important, crews must learn and practice restraint in what and when to engage; for example, every vehicle commander must know that he must confirm the target as hostile before issuing and executing any fire command.

Eliminating the risk of fratricide is no less critical as a training standard than are other mission requirements. All leaders must know all aspects of the applicable training standard, including fratricide prevention, and then ensure that their soldiers train to that standard.

SECTION 2 — EFFECTS OF FRATRICIDE

Fratricide results in unacceptable losses and increases the risk of mission failure; it almost always affects the unit's ability to survive and function. Units experiencing fratricide suffer these consequences:

- Loss of confidence in the unit's leadership.
- Increasing self-doubt among leaders.
- Hesitancy in the employment of supporting combat systems.
- Oversupervision of units.
- Hesitancy in the conduct of night operations.
- Loss of aggressiveness in maneuver (fire and movement).
- Loss of initiative.
- Disrupted operations.
- General degradation of unit cohesiveness, morale, and combat power.

SECTION 3 — CAUSES OF FRATRICIDE

The following paragraphs discuss the primary causes of fratricide. Leaders must identify any of the factors that may affect their units and then strive to eliminate or correct them.

FAILURES IN THE DIRECT FIRE CONTROL PLAN

These occur when units do not develop effective fire control plans, particularly in the offense. Units may fail to designate target engagement areas or adhere to target priorities, or they may position their weapons incorrectly. Under such conditions, fire discipline often breaks down upon contact.

The scout platoon can use a number of techniques and procedures to help prevent such incidents. An example is "staking in" vehicle and individual positions in the defense, using pickets to indicate the left and right limits of each position. An area of particular concern is the additional planning that must go into operations requiring close coordination between mounted elements and infantry squads. For example, because of the danger posed by discarding petals, sabot rounds should be fired over friendly infantry elements only in extreme emergencies.

LAND AND NAVIGATION FAILURES

Units often stray out of assigned sectors, report wrong locations, and become disoriented. Much less frequently, they employ fire support weapons from the wrong locations. In either type of situation, units that unexpectedly encounter an errant unit may fire their weapons at the friendly force.

FAILURES IN COMBAT IDENTIFICATION

Vehicle commanders and gunners cannot accurately identify thermal or optical signatures near the maximum range of their systems. In limited visibility, units within that range may mistake one another for the enemy.

INADEQUATE CONTROL MEASURES

Units may fail to disseminate the minimum necessary maneuver fire control measures and fire support coordination measures; they may also fail to tie control measures to recognizable terrain or events. As the battle develops, the plan then cannot address obvious branches and sequels as they occur. When this happens, synchronization fails.

FAILURES IN REPORTING AND COMMUNICATIONS

Units at all levels may fail to generate timely, accurate, and complete reports as locations and tactical situations change. This distorts the tactical "picture" available at each level and can lead to erroneous clearance of supporting fires.

WEAPONS ERRORS

Lapses in individual discipline can result in fratricide. These incidents include charge errors, accidental discharges, mistakes with explosives and hand grenades, and use of incorrect gun data.

BATTLEFIELD HAZARDS

A variety of explosive devices and materiel may create danger on the battlefield: unexploded ordnance; unmarked or unrecorded minefields, including scatterable mines; booby traps. Failure to mark, record, remove, or otherwise anticipate these threats will lead to casualties.

SECTION 4 — FRATRICIDE RISK ASSESSMENT

[Figure G-1](#) is a worksheet for evaluating fratricide risk in the context of mission requirements. The worksheet lists six mission-accomplishment factors that affect the risk of fratricide, along with related considerations for each factor. Leaders should assess the potential risk in each area (low, medium, or high) and assign a point value to each (one point for low risk, two for medium risk, three for high risk). They then add the point values to calculate the overall fratricide assessment score.

The resulting score is used only as a guide, however. The leader's final assessment must be based both on observable risk factors, such as those listed on the worksheet, and on his "feel" for the intangible factors affecting the operation. Note that descriptive terms are listed only in the low- and high-risk columns of the worksheet. The assessment of each factor will determine whether the risk matches one of these extremes or lies somewhere between them as a medium risk.

SECTION 5 — FRATRICIDE PREVENTION MEASURES

SPECIAL NOTE: In many situations, the primary cause of fratricide is the lack of positive target identification. To prevent fratricide incidents, commanders and leaders at all levels must ensure positive target identification before they issue commands to fire. In addition, all units must accurately report their locations during combat operations, and all tactical operations centers (TOC) and command posts (CP) must carefully track the location of all subordinate elements in relation to all friendly forces.

The measures outlined in this section, including those listed in the special note above, provide the platoon with a guide to actions it can take to reduce and/or prevent fratricide risk. These guidelines are not directive in nature, nor are they intended to restrict initiative. Commanders and leaders must learn to apply them as appropriate based on the specific situation and METT-TC factors. At the heart of fratricide reduction and prevention are five key principles:

- **Identify and assess potential fratricide risks in the estimate of the situation.** Express these risks in the OPORD and/or applicable FRAGOs.

Factors affecting fratricide	Potential risk categories (with variable conditions and point values)		
	Low risk (1 point)	Medium risk (2 points)	High risk (3 points)
UNDERSTANDING OF THE PLAN			
Commander's intent	Clear		Vague
Complexity	Simple	↔	Complex
Enemy situation	Known	↔	Unknown
Friendly situation	Clear		Unclear
ROE/ROI	Clear		Unclear
ENVIRONMENTAL FACTORS			
Intervisibility	Favorable		Unfavorable
Obscuration	Clear	↔	Obscured
Battle tempo	Slow	↔	Fast
Positive target ID	100 %		None (0 %)
CONTROL MEASURES			
Command relationships	Organic		Joint/combined
Audio communications	Loud / clear		Jammed
Visual communications	Easily seen		Obscured
Graphics	Standard	↔	Not understood
SOPs	Standard		Not used
Liaison personnel	Proficient		Untrained
Location/navigation	Sure		Unsure
EQUIPMENT (compared to US equipment)			
Friendly	Similar	↔	Different
Enemy	Different	↔	Similar
TRAINING			
Individual proficiency	MOS-qualified		Untrained
Unit proficiency	Trained		Untrained
Rehearsals	Realistic	↔	None
Habitual relationships	Yes		No
Endurance	Alert		Fatigued
PLANNING TIME (based on 1/3 - 2/3 rule)			
Higher headquarters	Adequate		Inadequate
Own unit	Adequate	↔	Inadequate
Subordinate elements	Adequate		Inadequate
Overall risk assessment (by total point value)	Low risk 26 - 46 points	Medium risk 42 - 62 points	High risk 58 - 78 points
NOTE: Point values alone may not accurately reflect fratricide risk. The commander must tailor his assessment to the unit's requirements.			

Figure G-1. Fratricide risk assessment worksheet.

- **Maintain situational awareness.** Focus on such areas as current intelligence; unit locations/dispositions; denial areas (minefields/scatterable mines); contaminated areas, such as ICM and NBC; SITREPs; and METT-TC factors.
- **Ensure positive target identification.** Review vehicle and weapons identification (ID) cards. Become familiar with the characteristics of potential friendly and enemy vehicles, including their silhouettes and thermal signatures. Know at what ranges and under what conditions positive identification of various vehicles and weapons is possible. (**NOTE:** Refer to the special note at the start of this section.)
- **Maintain effective fire control.** Ensure fire commands are accurate, concise, and clearly stated. Make it mandatory for crewmen to ask for clarification of any portion of the fire command that they do not completely understand. Stress the importance of the chain of command in the fire control process; ensure crewmen get in the habit of obtaining target confirmation and permission to fire from their leaders before engaging targets they assume are enemy elements.
- **Establish a command climate that emphasizes fratricide prevention.** Enforce fratricide prevention measures, placing special emphasis on the use of doctrinally sound TTP. Ensure constant supervision in the execution of orders and in the performance of all tasks and missions to standard.

Additional guidelines and considerations fratricide reduction and prevention include the following:

- Recognize the signs of battlefield stress. Maintain unit cohesion by taking quick, effective action to alleviate stress.
- Conduct individual, leader, and collective (unit) training covering fratricide awareness, target identification and recognition, and fire discipline.
- Develop a simple, decisive plan.
- Give complete and concise mission orders.
- To simplify mission orders, use SOPs that are consistent with doctrine. Periodically review and update SOPs as needed.
- Strive to provide maximum planning time for leaders and subordinates.
- Use common language/vocabulary and doctrinally correct standard terminology and control measures, such as the fire support coordination line (FSCL), zone of engagement, and restrictive fire line (RFL).
- Ensure thorough coordination is conducted at all levels.
- Plan for and establish effective communications.
- Plan for collocation of CPs whenever it is appropriate to the mission, such as during a passage of lines.
- Designate and employ LOs as appropriate.
- Make sure ROE are clear.
- Conduct rehearsals whenever the situation allows the platoon adequate time to do so.
- Be in the right place at the right time. Use position location/navigation devices (GPS and POSNAV); know your location and the locations of adjacent units (left, right, leading, and follow-on); and synchronize tactical movement. If the platoon or any element becomes lost or misoriented, leaders must know how to contact higher headquarters immediately for instructions

and assistance.

- Include a discussion of fratricide incidents in all AARs.

SECTION 6 — STOPPING A FRIENDLY FIRE INCIDENT

The scout platoon may become involved in a friendly fire incident in one of several ways: as the victim of the fire; as the firing element; or as an observer intervening in an attack of one friendly element on another. This section covers actions that leaders and crewmen must be prepared to take when they encounter such situations.

ACTIONS AS VICTIM OF FRIENDLY FIRE

The following are recommended actions at crew and leader level in the event the crew falls victim to friendly fires:

- React to contact until you recognize friendly fire.
- Cease fire.
- Take immediate actions to protect soldiers and vehicles.
- Use a visual recognition signal directing the firing unit to cease fire.
- Report the following on the next higher unit net:
 - Announce that you are receiving friendly fire.
 - Request medical assistance as needed.
 - Give the location and direction of the firing vehicles.
 - Warn the higher unit not to return fire if you identify the firing unit as friendly.

ACTIONS AS FIRING ELEMENT

The following are recommended actions at crew and leader level when the crew has engaged friendly forces:

- Cease fire.
- Report the following on the next higher net:
 - Identification of the engaged friendly force (if the unit is unidentified, report number and type of vehicles).
 - The location of the incident.
 - Direction and distance to the engaged force.
 - The type of fire.
 - The target effects.

ACTIONS AS OBSERVER OF FRIENDLY FIRE

The following are recommended actions at crew and leader level in the event the crew observes a friendly fire incident:

- Seek cover and protect yourself.
- Use a visual recognition signal directing the firing unit to cease fire.

- Report the following on the next higher net:
 - Identification of the engaged friendly force (if the unit is unidentified, report number and type of vehicles).
 - The location of the incident.
 - Direction and distance to the victim and the firing unit.
 - The type of fire.
 - The target effects.
- Provide assistance as needed (when safe to do so).

LEADER RESPONSIBILITIES

In all situations involving the risk of fratricide and friendly fire, leaders must be prepared to take immediate actions to prevent casualties as well as equipment damage or destruction. Recommended actions in fratricide situations include the following:

- Identify the incident and order the parties involved to cease fire.
- Conduct an in-stride risk assessment.
- Identify and implement controls to prevent the incident from recurring.

Glossary

A

AA	avenue of approach; assembly area
AAR	after-action review
ABF	attack by fire (position)
ACE	armored combat earthmover
ACR	armored cavalry regiment
ADA	air defense artillery
AGMB	advance guard main body (enemy force)
AI	area of interest
A/L	administrative/logistics
ammo	ammunition
AP	antipersonnel
APC	armored personnel carrier
APDS	armor-piercing, discarding-sabot (ammunition)
AT	antitank
AVLB	armored vehicle launched bridge

B

bde	brigade
BFV	Bradley (infantry) fighting vehicle
BHL	battle handover line
BMNT	beginning of morning nautical twilight
bn	battalion
BP	battle position
BRIDGEREP	report of bridge, overpass, culvert, underpass, or tunnel
BSA	brigade support area
BSFV	Bradley Stinger (missile) fighting vehicle

C

CAM	chemical agent monitor
CANA	convulsant antidote for nerve agent
CAS	close air support
CASEVAC	casualty evacuation
CBU	cluster bomb unit
CCIR	commander's critical information requirements
cdr	commander
CFV	(Bradley) cavalry fighting vehicle
cGy/hr	centigray(s) per hour

CITV	commander's independent thermal viewer
co tm; co/tm	company team
COA	course of action
COLT	combat observation lasing team
COMSEC	communications security
CP	command post
CROSSREP	report of ford, ferry, or other water crossing site
CRP	combat reconnaissance patrol (enemy unit)
CS	combat support
CSS	combat service support
CTCP	combat trains command post
CVC	combat vehicle crewman

D

DA	Department of the Army
DAP	decontamination apparatus
DD	Department of Defense
DED	detailed equipment decontamination
div	division
DP	decision point (illustration text)
DPICM	dual-purpose improve conventional munitions

DS direct support

DST decision support template

DTD detailed troop decontamination

E

EA engagement area

EENT end of evening nautical twilight

en; EN enemy

enr engineer(s)

EPW enemy prisoner of war

ESTAT equipment status report

EW electronic warfare

F

1LT first lieutenant

1SG first sergeant

FA field artillery

FAC forward air controller

FDC fire direction center

FEBA forward edge of the battle area

FIST fire support team

FKSM	Fort Knox Supplemental Material
FLOT	forward line of own troops
FM	frequency modulation (radio); field manual
FO	forward observer
FPF	final protective fires
FRAGO	fragmentary order
FS	fire support
FSCL	fire support coordination line
FSCOORD	fire support coordinator
FSE	fire support element; forward security element (enemy forces only)
FSO	fire support officer
FWF	former warring factions
FY	fiscal year

G

GIRS	grid index reference system
gpm	gallons per minute
GPS	global positioning system
GS	general support
GSR	ground surveillance radar

H

H	hour (used for timeline designation)
HAB	heavy assault bridge
HE	high explosive
HEI-T	high explosive incendiary tracer (ammunition)
HEP-T	high explosive plastic tracer (ammunition)
HHC	headquarters and headquarters company
HMMWV	high-mobility multipurpose wheeled vehicle
HPT	high-priority target
HQ	headquarters
hr	hour(s)
HVT	high-value target

I J k

ICM	improved conventional munitions
ID	identification
IEDK	individual equipment decontamination kit
IFF	identification friend or foe
IFSAS	initial fire support automated system
IPB	intelligence preparation of the battlefield
IR	infrared

JAAT joint air attack team

KIA killed in action

kmph kilometer(s) per hour

L

lb pound(s)

LBE load-bearing equipment

LD line of departure

LD/LC line of departure is line of contact

LD line of departure

LO liaison officer

LOA limit of advance

LOGPAC logistics package

LP listening post

LRP logistic release point

LT lieutenant

LZ landing zone

M

m meter(s)

MANPADS man-portable air defense system

MBA	main battle area
MC	mobility corridor
MCOO	modified combined obstacle overlay
MDMP	military decision-making process
mech	mechanized
MEDEVAC	medical evacuation
METL	mission essential task list
METT-TC	mission, enemy, terrain (and weather), troops, time available, and civilian considerations (factors taken into account in situational awareness and in the mission analysis process)
MIJI	meaconing, intrusion, jamming, and interference
min	minute(s)
MLC	military load class
mm	millimeter(s)
MMS	mast mounted sight
MOPP	mission-oriented protective posture
MOS	military occupational specialty
MOUT	military operations on urbanized terrain
mph	mile(s) per hour
MRE	meals, ready to eat
MSR	main supply route

MTP mission training plan

N

NA not applicable

NAAK nerve agent autoinjector kit

NAI named area(s) of interest

NBC nuclear, biological, chemical

NBCWRS NBC warning and reporting system

NCO noncommissioned officer

NCOIC noncommissioned officer in charge

NCS net control station

NEO noncombatant evacuation operation

NGO nongovernmental organization

NLT not later than

NOD night observation device

O

obj objective

OBSTINTEL obstacle intelligence

OCIE organization clothing and individual equipment

OCOKA observation and fields of fire; cover and concealment; obstacles; key terrain; and avenues of approach (considerations in evaluating terrain as part of METT-T analysis)

OEG operational exposure guidance

OI operations and intelligence

OIC officer in charge

OP observation post

OPCON operational control

OPLAN operational plan

OPORD operation order

OPSEC operations security

ORP objective rally point

OT observer-target

P

P persistent chemical agent (abbreviation on overlays)

PAO public affairs office; public affairs officer

PCC precombat check

PCI precombat inspection

PDDE power-driven decontamination equipment

PEWS platoon early warning system

PFC private first class

PIR priority intelligence requirements

PL phase line; platoon leader

PLGR	precision lightweight GPS receiver ("Plugger")
PLL	prescribed load list
plt	platoon
PMCS	preventive maintenance checks and services
POC	point of contact
POL	petroleum, oils, and lubricants
PP	passage point (abbreviation on overlays)
PSG	platoon sergeant
psi	pounds per square inch
PX	post exchange
PZ	pickup zone

R

R&S	reconnaissance and surveillance
RAA	reconnaissance avenue of approach
recon	reconnaissance; reconnoiter
REDCON	readiness condition
regt	regiment
REMBASS	remotely monitored battlefield sensor system
RES	radiation exposure status

retrans	retransmission
RFL	restrictive fire line
RISTA	reconnaissance, intelligence, surveillance, and target acquisition
ROE	rules of engagement
ROI	rules of interaction
ROUTEREP	route (reconnaissance) report
RP	release point
RSI	reconnaissance, surveillance, and intelligence
rte	route
RTO	radiotelephone operator
RTP	radiotelephone procedure

S

2LT	second lieutenant
S1	personnel staff officer (US Army)
S2	intelligence staff officer (US Army)
S3	operations and training staff officer (US Army)
S3-Air	air operations staff officer (US Army)
S4	logistics staff officer (US Army)
S5	civil-military operations staff officer (US Army)
S6	communications staff officer (US Army)

SALUTE	size, activity, location, unit identification, time, and equipment (format for reporting enemy information)
SAW	squad automatic weapon
sct	scout
sec	section; second(s)
SENSEREP	sensitive items report
SFC	sergeant first class
SGT	sergeant
SHORAD	short-range air defense
SIR	specific information requirements
SITEMP	situational template
SITREP	situation report
SOI	signal operation instructions
SOP	standing operating procedure
SOR	specific orders and requests
SOSR	suppression, obscuration, security, and reduction(actions executed during breaching operations)
SP	start point
SPEC	specialist
SPOTREP	spot report
sqd	squad

SSG staff sergeant

T

TAC CP tactical command post

TACFIRE tactical fire direction system

TAI target area(s) of interest

TBM tactical ballistic missile

TC technical circular

TCP traffic control point

TF task force

TIRS terrain index reference system

TOC tactical operations center

TOE table(s) of organization and equipment

TOW tube-launched, optically tracked, wire-guided (missile)

TP-T target practice-tracer (ammunition)

TRP target reference point

TSOP tactical standing operating procedure

TTP tactics, techniques, and procedures

U

UAV unmanned aerial vehicle

UMCP unit maintenance collection point

US United States (of America)

USAARMC US Army Armor Center

USAARMS US Army Armor School

V W X

veh vehicle

WIA wounded in action

WP white phosphorus

XO executive officer

References

SOURCES USED

These sources are quoted or paraphrased in this publication.

Army Publications

[ARTEP 17-57-10-MTP](#)

Mission Training Plan for the Scout Platoon. 9 October 1996.

[FM 7-7J](#)

Mechanized Infantry Platoon and Squad (Bradley). 7 May 1993.

[FM 7-8](#)

Infantry Rifle Platoon and Squad. 22 April 1992.

[FM 17-15](#)

Tank Platoon. 3 April 1996.

[FM 17-95](#)

Cavalry Operations. 24 December 1996.

[FM 17-97](#)

Regimental Armored Cavalry Troop. 9 September 1994.

[FM 71-1](#)

Tank and Mechanized Infantry Company Team. 26 January 1998.

Command Publications

The following command publications, published by the US Army Armor Center and School as Fort Knox Supplementary Material (FKSM), cannot be obtained through Armywide resupply channels. Determine availability by contacting the following address:

Commander
USAARMC
ATTN: ATZK-IMO-RA-P
Fort Knox, KY 40121-5000

FKSM 17-97-3

Cavalry Troop Common SOP. 15 July 1994.

FKSM 17-98-3

Scout Platoon SOP. November 1994.

FKSM 17-98-4

Scout Platoon Leader's Notebook. June 1996.

DOCUMENTS NEEDED

These sources are quoted or paraphrased in this publication.

Army Forms

DA Form 1155

Witness Statement on Individual. June 1966.

DA Form 1156

Casualty Feeder Report. June 1966.

DA Form 1971-R

Radiological Data Sheet Monitoring and Point Technique. September 1994.

DA Form 2028

Recommended Changes to Publications and Blank Forms. February 1974.

DA Form 2408-18

Equipment Inspection List. November 1991

DA Form 5988-E

Equipment Inspection Maintenance Worksheet. March 1991.

Department of Defense Forms

DD Form 551

Record of Interment. August 1984.

DD Form 1077

Collecting Point Register of Deceased Personnel. July 1984.

READINGS RECOMMENDED

These readings contain relevant supplemental information.

Army Publications

[ARTEP 17-237-10-MTP](#)

Mission Training Plan for the Tank Platoon. 25 September 1996.

[ARTEP 17-487-30-MTP](#)

Mission Training Plan for the Regimental Armored Cavalry Troop. 3 September 1991.

[FM 1-114](#)

Tactics, Techniques, and Procedures for the Regimental Aviation Squadron. 20 February 1991.

[FM 3-3](#)

Chemical and Biological Contamination Avoidance. 16 November 1992.

[FM 3-3-1](#)

Nuclear Contamination Avoidance. 9 September 1994.

[FM 3-4](#)

NBC Protection. 29 May 1992.

[FM 3-5](#)

NBC Decontamination. 17 November 1993.

[FM 3-50](#)

Smoke Operations. 4 December 1990.

[FM 3-100](#)

Chemical Operations, Principles, and Fundamentals. 8 May 1996.

[FM 3-101](#)

Chemical Staffs and Units. 19 November 1993.

[FM 5-36](#)

Route Reconnaissance and Classification. 10 May 1985.

[FM 5-100](#)

Engineer Operations. 27 February 1996.

[FM 5-103](#)

Survivability. 10 June 1985.

[FM 5-114](#)

Engineer Operations Short of War. 13 July 1992.

[FM 5-250](#)

Explosives and Demolitions. 30 July 1998.

[FM 6-20](#)

Fire Support in the AirLand Battle. 17 May 1988.

[FM 6-20-50](#)

Tactics, Techniques, and Procedures for Fire Support for Brigade Operations (Light). 5 January 1990.

[FM 7-10](#)

The Infantry Rifle Company. 14 December 1990.

[FM 7-20](#)

The Infantry Battalion. 6 April 1992.

- [FM 7-30](#) The Infantry Brigade. 3 October 1995.
- [FM 7-90](#) Tactical Employment of Mortars. 9 October 1992.
- [FM 7-91](#) Tactical Employment of Antiarmor Platoons, Companies, and Battalions. 30 September 1987.
- [FM 7-92](#) The Infantry Reconnaissance Platoon and Squad (Airborne, Air Assault, Light Infantry). 23 December 1992.
- [FM 7-98](#) Operations in a Low-Intensity Conflict. 19 October 1992.
- [FM 8-55](#) Planning for Health Service Support. 9 September 1994.
- [FM 12-6](#) Personnel Doctrine. 9 September 1994.
- FM 14-7** Finance Operations. 17 August 1994.
- [FM 16-1](#) Religious Support. 26 May 1995.
- [FM 17-12-8](#) Light Cavalry Gunnery. 16 February 1999.
- [FM 19-40](#) Enemy Prisoners of War, Civilian Internees, and Detained Persons. 27 February 1976.
- [FM 20-32](#) Mine/Countermine Operations. 29 May 1998.
- [FM 21-10](#) Field Hygiene and Sanitation. 22 November 1988.
- [FM 21-10-1](#) Unit Field Sanitation Team. 11 October 1989.
- [FM 21-11](#) First Aid for Soldiers. 27 October 1988.
- [FM 21-76](#) Survival. 5 June 1992.
- [FM 22-100](#) Military Leadership. 31 July 1990.
- [FM 23-1](#) Bradley Gunnery. 18 March 1996.
- FM 26-2** Management of Stress in Army Operations. 29 August 1986.
- [FM 31-70](#) Basic Cold Weather Manual. 12 April 1968.
- [FM 33-1](#) Psychological Operations. 18 February 1993.
- [FM 34-1](#) Intelligence and Electronic Warfare Operations. 27 September 1994.
- [FM 34-2-1](#) Tactics, Techniques, and Procedures for Reconnaissance and Surveillance and Intelligence Support to Counterreconnaissance. 19 June 1991.
- FM 34-3** Intelligence Analysis. 15 March 1990.
- [FM 34-130](#) Intelligence Preparation of the Battlefield. 8 July 1994.
- FM 44-1** US Army Air Defense Employment. 9 May 1983.
- [FM 41-10](#) Civil Affairs Operations. 11 January 1993.
- FM 44-3** Air Defense Artillery Employment: Chaparral/Vulcan/Stinger. 15 June 1984.
- [FM 44-8](#) Small Unit Self-Defense Against Air Attack. 30 December 1981.
- [FM 44-18-1](#) Stinger Team Operations. 31 December 1984.

FM 44-64	SHORAD Battalion and Battery Operations. 5 June 1997.
<u>FM 44-100</u>	US Army Air Defense Operations. 15 June 1995.
<u>FM 55-9</u>	Unit Air Movement Planning. 5 April 1993.
<u>FM 57-38</u>	Pathfinder Operations. 9 April 1993.
<u>FM 71-2</u>	The Tank and Mechanized Infantry Battalion Task Force. 27 September 1988.
<u>FM 71-3</u>	The Tank and Mechanized Infantry Brigade. 8 January 1996.
FM 90-2	Battlefield Deception. 3 October 1988.
<u>FM 90-3</u>	Desert Operations. 24 August 1993.
<u>FM 90-4</u>	Air Assault Operations. 16 March 1987.
FM 90-6	Mountain Operations. 30 June 1980.
<u>FM 90-8</u>	Counter guerrilla Operations. 29 August 1986.
FM 90-10(HTF)	Military Operations on Urbanized Terrain (MOUT). 15 August 1979.
<u>FM 90-10-1</u>	An Infantryman's Guide to Combat in Built-up Areas. 12 May 1993.
<u>FM 90-13-1</u>	Combined Arms Breaching Operations. 28 February 1991.
FM 90-14	Rear Battle. 10 June 1985.
<u>FM 90-22</u>	Multiservice Night and Adverse Weather Combat Operations. 31 January 1991.
<u>FM 90-26</u>	Airborne Operations. 18 December 1990.
<u>FM 100-5</u>	Operations. 14 June 1993.
<u>FM 100-10</u>	Combat Service Support. 3 October 1995.
<u>FM 100-15</u>	Corps Operations. 29 October 1996.
<u>FM 100-19</u>	Domestic Support Operations. 1 July 1993.
<u>FM 100-20</u>	Military Operations in Low Intensity Conflict. 5 December 1990.
<u>FM 100-23</u>	Peace Operations. 30 December 1994.
<u>FM 100-25</u>	Doctrine for Army Special Operations Forces. 12 December 1991.
<u>FM 100-27</u>	US Army/US Air Force Doctrine for Joint Airborne and Tactical Airlift Operations. 31 January 1985.
FM 100-37	Terrorism Counteraction. 24 July 1987.
<u>FM 101-5</u>	Staff Organization and Operations. 31 May 1997.
<u>FM 101-5-1</u>	Operational Terms and Graphics. 30 September 1997.
TB MED 524	Occupational and Environmental Health: Control of Hazards to Health from Laser Radiation. 20 June 1985.

Joint and Multiservice Publications

Joint Publication 3-07.2

Joint Tactics, Techniques, and Procedures for Antiterrorism. 17 March 1998.

Joint Publication 3-07.3

Joint Tactics, Techniques, and Procedures for Peacekeeping Operations. 29 April 1994.

FM 17-98
10 APRIL 1999

By Order of the Secretary of the Army:

Official:



JOEL B. HUDSON

*Administrative Assistant to the
Secretary of the Army*

9916601

DENNIS J. REIMER
*General, United States Army
Chief of Staff*

DISTRIBUTION:

Active Army, Army National Guard, and U. S. Army Reserve: To be distributed in accordance with the initial distribution number 111041, requirements for FM 17-98.